

Now Create  
and Manage Test  
Reports with  
AnyWARE Cloud



# PoE Pro

## User Manual Bluetooth Version



TREND NETWORKS

Depend On Us

PoE Pro

User Manual

158835 Rev.1 (2022)

© **TREND NETWORKS 2022**

The information contained in this document is the property of TREND NETWORKS and is supplied without liability for errors and omissions. No part of this document may be reproduced or used except as authorized by contract or other written permission from TREND NETWORKS. The copyright and all restrictions on reproduction and use apply to all media in which this information may be placed. TREND NETWORKS pursues a policy of continual product improvement and reserves the right to alter without notice the specification, design, price or conditions of supply of any product or service. All rights reserved.

TREND NETWORKS  
Stokenchurch House  
Oxford Road  
Stokenchurch  
High Wycombe  
Buckinghamshire  
HP14 3SX  
United Kingdom



**WARNING!**

Do not attach to AC power or telecoms cables carrying >60volts. The PoE Pro Tester may be damaged and cause a safety hazard to the user.



**CAUTION!**

Improperly crimped, damaged or un-crimped plugs can damage the ports on the PoE Pro Tester. Inspect plugs for proper termination and crimping before inserting into the tester. Contacts should always be recessed into the plastic grooves of the plug. Only use 8-Position plugs with the 8-Pin (DATA) port and 6-Position plugs with the 6-Pin (VOICE) port.

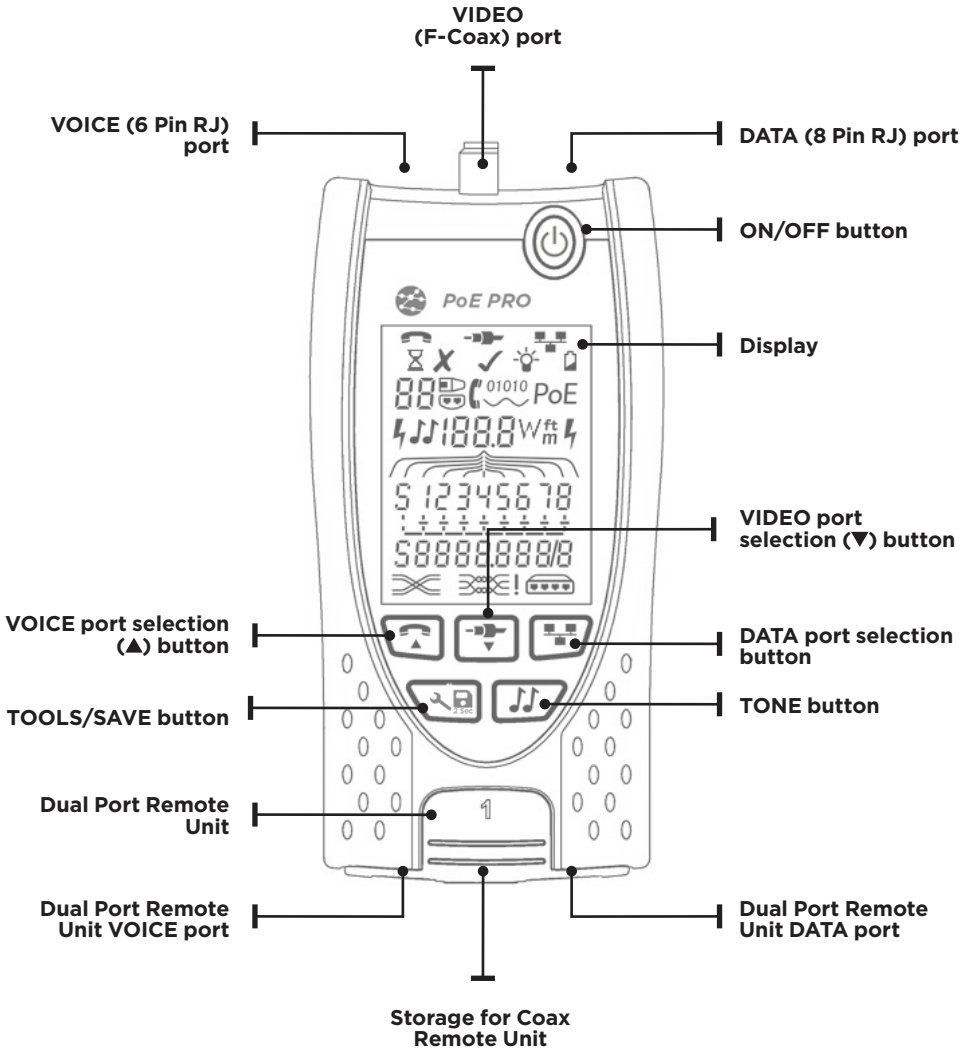

## POWER

### To remove / insert the battery:

- Remove the battery cover screw and the battery cover from the back of the tester.
- Remove / insert the battery, taking care to connect correctly and not to trap the cable.
- Replace the battery cover and screw.

### To switch the tester ON:

Press the ON/OFF button.

- The display shows the selected port (VOICE, VIDEO or DATA).
- If the Battery Low Indicator is shown, the battery should be replaced with a new 9V battery.

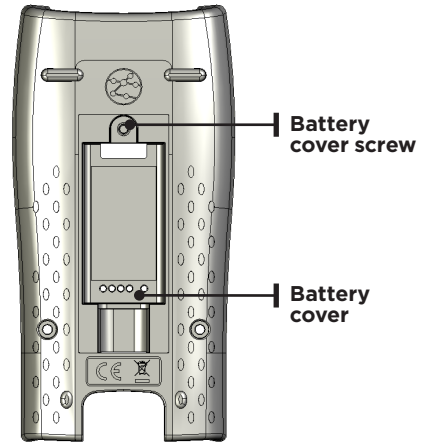

VOICE  
port  
selected



VIDEO  
port  
selected



DATA port  
selected



Setting  
Indicator



Backlight  
Indicator



Battery  
Low  
Indicator

### Settings:



- Press the TOOLS/SAVE  button to enter the settings menu.
- Each press of the TOOLS/SAVE button advances to the next setting. The available settings are,
  - Port blink, On or Off
  - NVP setting
  - Backlight timer
  - Length units, ft/m
  - PoE test mode, Lo or Hi
  - Wiremap test mode, 4-pair or 2-pair
  - Bluetooth, On or Off
- Press ▼ or ▲ to cycle through the available options for each setting.

- Press the TOOLS/SAVE button repeatedly until the Setting Indicator disappears.

### Port Blink

When set to ON causes the link LED on the connected port to slowly flash, enabling visual location of the switch port. The PoE Pro can also be connected directly to an Ethernet device to check if it's port is responding to link pulses.

- Press ▼ or ▲ turn Port Flash On (check symbol).
- Connect to an active Ethernet port/cable.
- The link LED on the switch will flash 2 seconds on, 2 seconds off then repeat.
- Press ▼ or ▲ turn Port Flash Off (X symbol).

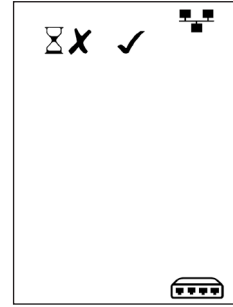

### NVP Calibration

Adjust the NVP (Nominal Velocity of Propagation) value to calibrate the TDR to the electrical characteristics of the cable being tested.

Select the NVP value from the cable data sheet. If the data sheet is not available, connect a known length of cable (at least 20ft/6m long) and adjust the NVP until the displayed length matches the length of the cable.

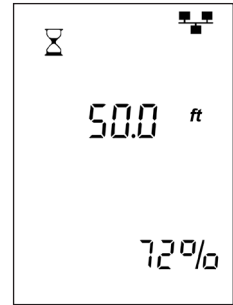

### Backlight Timer

Adjust the backlight timer in steps of 0 (off), 10, 30, 60, or 300 seconds. The backlight timer resets each time a button is pressed. The backlight timer is disabled when connected to an Ethernet switch or PoE switch/injector.

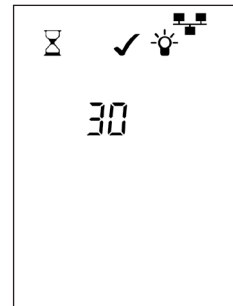

### Length Units

Toggle the length measurement between feet (ft) and meters (m) using the ▼ or ▲ buttons.

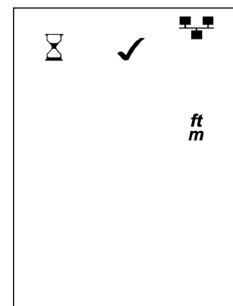

## PoE Test Mode (PoE Pro Only)

When performing the PoE load test, the PoE Pro can be set to draw either the minimum or maximum amount of power from the detected Class of PSE (Power Sourcing Equipment).

For example, a Class 6 PSE should deliver a minimum of 51 watts to a device at the end of a 100m/328ft cable, and a maximum of 60 watts at the PSE port with no cable loss.

- If set to Hi, the PoE Pro will attempt to draw 59 watts from a Class 6 PSE (maximum for the class minus 1 watt to prevent overload). The Hi setting should be used when testing directly at a PSE port or when testing short cables with little loss.
- If set to Lo, the PoE Pro will attempt to draw 51 watts from a Class 6 PSE. The Lo setting should be used when testing at the device end of installed cabling to ensure the delivered power meets the minimum requirement for the PSE Class.

Reference the PoE Class chart later in the manual for the minimum and maximum power for each PSE Class.

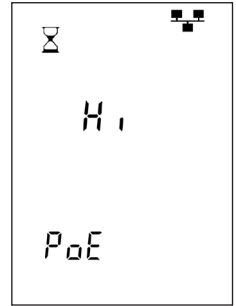

## 2 or 4 Pair Testing

The PoE Pro can be set to test 4 pair cable (default setting) or 2 pair cable.

In 2 pair mode, the test will Pass when pins 1,2,3 and 6 are connected. 2 pair mode should be used when testing industrial cabling using RJ45-to-M12 patch cords.

- Press ▼ or ▲ to toggle between the 4PAir and 2PAir modes.

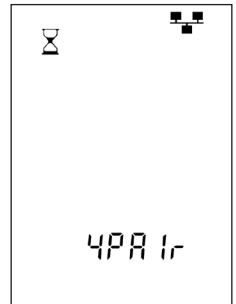

## Bluetooth Settings

Turn the Bluetooth radio ON or OFF using the ▼ or ▲ buttons.

The unique ID of the tester is shown at the bottom of the screen.

The ID of the tester will be displayed when connecting the tester to the TREND AnyWARE Cloud App.

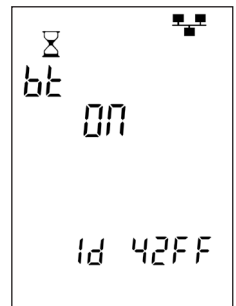

## TERMINATIONS

The Dual Port Remote Unit can be stored in the bottom end of the Tester, with the jacks either inside for protection or outside for testing patch cables without removing it from the Tester, and provides internal storage for the Coax Remote Unit.



**Dual Port Remote Unit**

# 1 (Standard)



**Coax Remote Unit**

# 1 (Standard)  
# 1 to 12 (Optional - 158053)



**RJ45 Remote Unit**

# 1 to 12 (Optional - 158050)

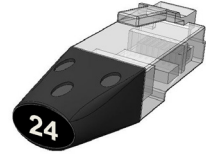

**RJ45 Identifier**

# 1 to 24 (Optional - 158051)

## CONNECTIONS

To connect to a cable and to confirm correct connection:

- Use the correct port (VOICE, VIDEO or DATA) according to the cable connector type. (Use VOICE for RJ11, RJ12, RJ14 or RJ25 cables, VIDEO for F 75  $\Omega$  Coax or DATA for RJ45).
- Press the corresponding port button (VOICE, VIDEO or DATA).
- The display shows the selected port.
- Connect one end of the cable to the selected port on the tester and the other end to a Remote Unit for cable identification and testing or to an Identifier for cable identification only.
- The display shows the type of termination (Remote Unit or Identifier) and its Number to assist identification when a number of different terminations are in use.

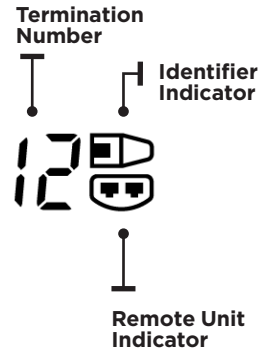

# PoE TESTING

## To test PoE:

- Turn on the PoE Pro tester
- Connect the RJ45 port of the tester to the PoE port or cable to be tested.
- Press the Network button 

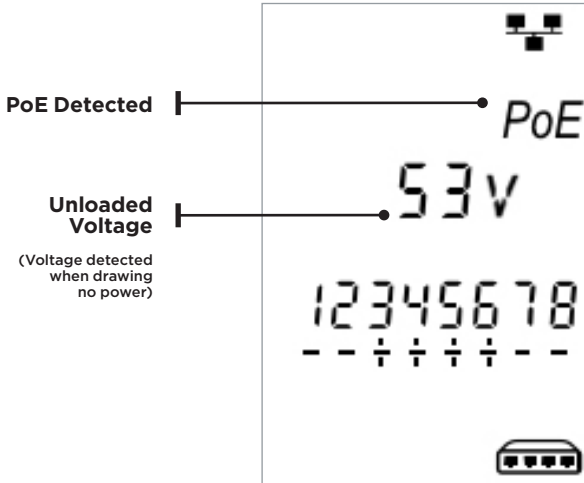

Above screen is displayed when PoE is detected without an Ethernet signal (PoE Injector with input from a switch). It will be shown for two seconds.

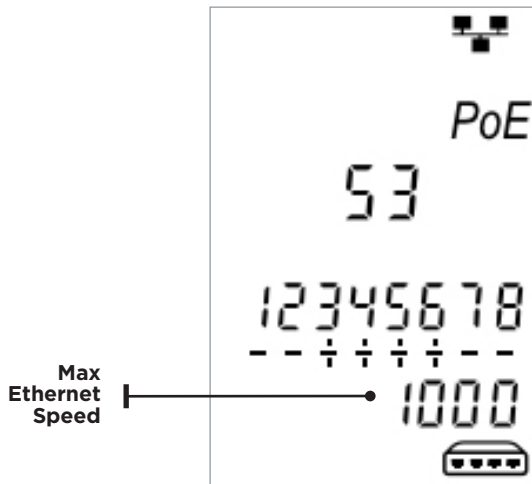

If Ethernet is detected, the maximum detected link speed will be shown with the no-load PoE voltage for two seconds.



After PoE detection is confirmed the PoE Pro will begin the test to classify the PSE.

This process will take up to 50 seconds.

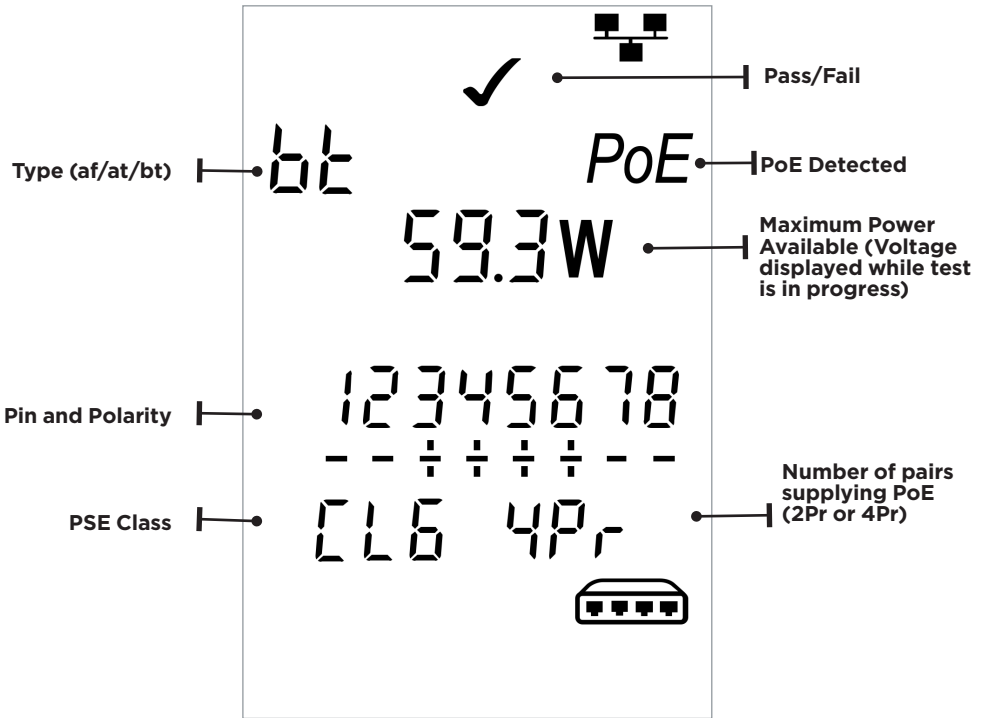

## METHOD OF OPERATION

The PoE PRO operates by detecting “pulses” from a PoE power supply Power Source Equipment (PSE). These pulses advertise the PSE’s Class which determines the maximum amount of power it can supply.

The PoE PRO configures itself to the same Class as the PSE, simulating a powered device (PD), and demands the maximum power that should be available for the advertised Class.

The initial test measures the voltage supplied by the PSE with no load. This voltage should be 48V or greater when connected directly to the PSE. When testing for maximum available power, the PoE PRO will apply a variable load to the cable while measuring the voltage and current delivered by the PSE. The voltage and current measurements are used to calculate power (watts).

# UNDERSTANDING THE RESULTS

## Volts

Voltage displayed on the results screen is the “loaded” voltage. It is the voltage measured when the PoE PRO applies a load to the cable, simulating a PoE device (PD).

This voltage may be lower than the unloaded voltage displayed when initially connected.

## Watts

Maximum available power is displayed in watts (**W**). This is the most power the PoE PRO is able to demand from the PoE supply during the test.

## Type (af / at / bt /-)

Displays the IEEE 802.3 standard to which the connected PSE is compatible.

**af = IEEE 802.3af**

**at = IEEE 802.3at**

**bt = IEEE 802.3bt**

## Class (0 - 8 or “-“)

Displays the advertised Class of the Power Sourcing Equipment (PSE). The class determines the maximum amount of power the PSE can supply.

The PoE PRO will adjust its internal load and attempt to pull the maximum power the advertised Class supports. The chart below cross-references Class to supported power.

A “-” will be displayed when the PSE does not support 802.3af/at/bt negotiation.

This is typical of passive mid-span

injectors that apply voltage to the line regardless of the connected network device.

## Pass / Fail Indication

The test will pass (✓) if the power available during the PoE load test is equal to, or greater than the MINIMUM power for PSE Class.

**Example:** If class 4 is detected the test will PASS if 25.5 W or more watts is delivered. If less than 25.5 W watts is delivered the test will FAIL.

Class	Minimum and Maximum Power for each Class
0 (→)	12.9 - 15.4 W
1	3.8 - 4.0 W
2	6.5 - 7.0 W
3	12.9 - 15.4 W
4	25.5 - 30.0 W
5	40 - 45 W
6	51 - 60 W
7	62 - 75 W
8	73 - 90 W

### **Pairs (2Pr / 4Pr)**

Displays whether the PSE is supplying power on 2 or 4 pairs of the connected cable.

2Pr is shown for 802.3af, 802.3at or some non-standard compliant PoE injectors.

4Pr is shown for 802.3bt or some non-standard compliant “HPoE” or “Ultra PoE” injectors.

### **Pins (1 - 8)**

Displays the pins of the RJ45 connector used for PoE and the polarity of each pin.

A “+” below the pin number indicates a positive DC voltage is present.

A “-” below the pin number indicates a negative DC voltage is present.

If a pin is not used the area below the number will be blank.

### **Mid-span vs End-point**

Generally, an “end-point” PSE like a PoE enabled Ethernet switch will use pins 1,2,3 and 6 for PoE.

A “mid-span” injector will generally use pins 4,5,7 and 8 for PoE.

The pin display can be used to determine whether the PSE is a switch or injector, although the IEEE 802.3 standards do not call for this specific pin use.

# CABLE TESTING

## To test a cable:

Connect the cable to the tester and to a suitable Remote Unit as described above.

- Cable testing runs continuously (except when in TOOLS/SAVE mode or if voltage is detected). There is no need to start or stop the cable test.

Cable test results are shown using the two rows of numbers in the lower half of the display. The top row of numbers refers to the pins at the near end. The numbers displayed, and **S** (Shield), depend on the port in use...

## Split Pair test:

! next to the Split Pair symbol shows when the test is disabled.

- When the Split Pair test is enabled, split pairs will cause the test to fail.
- When the Split Pair test is disabled, split pairs will not cause the test to fail.

**VOICE** – Pins 1, 2, 3, 4, 5 and 6 are shown

**VIDEO** – S and Pin 1 are shown

**DATA** – Pins 1, 2, 3, 4, 5, 6, 7 and 8 are shown. S is shown if the shield is connected.

The lower row of numbers refers to the pins at the far end. The numbers displayed show which pin at the far end is connected to which pin at the near end. Open circuits and short circuits are shown. Multiple short circuits are shown in sequence.

## To disable / enable the Split Pair test:

Press and hold the port selection button of the currently selected port for 2 seconds to change the setting.

- The Split Pair test is disabled or enabled.

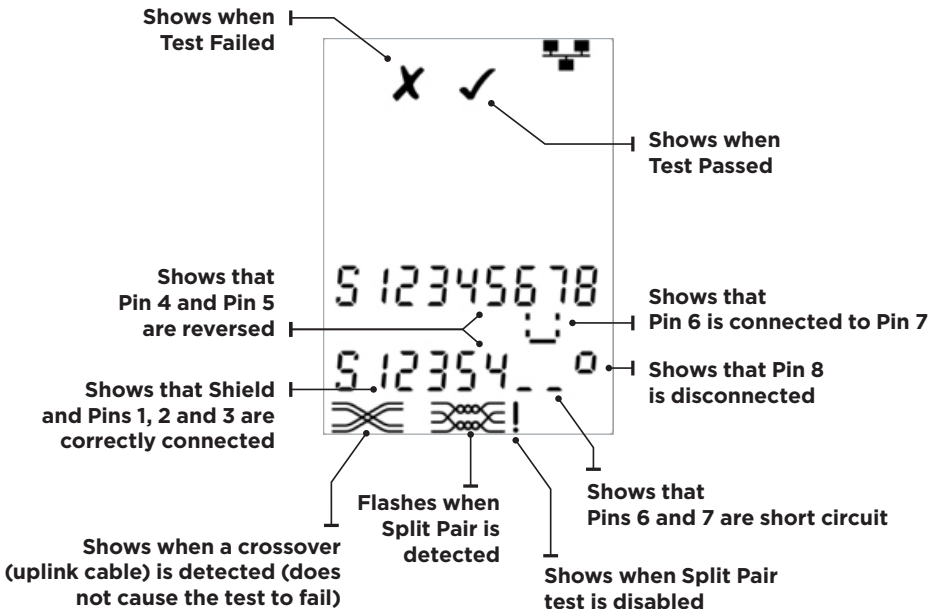

# LENGTH MEASUREMENT

Cable length can be measured using the built-in Time Domain Reflectometer (TDR) with either an open circuit or short circuit or a Remote Unit or Identifier at the far end. Any TDR can only be used to measure the length of cables with uniform Characteristic Impedance. The TDR may not give reliable results on cables that are not correctly twisted or using crocodile clips to connect to the cable.

Accurate length measurement relies on correct setting of the Nominal Velocity of Propagation (NVP) for the cable to be tested. This can be determined either from the cable manufacturer's data or by testing a known length of cable of the same type as the cable to be tested.

## To set the NVP:

- Connect a known length (>15m / 50ft) of cable to the tester (if available).
- Press the TOOLS/SAVE button repeatedly until the NVP setting flashes.
- Press ▼ or ▲ until either the required NVP or the known cable length is displayed.
- Press the TOOLS/SAVE button repeatedly until the Setting Indicator disappears.

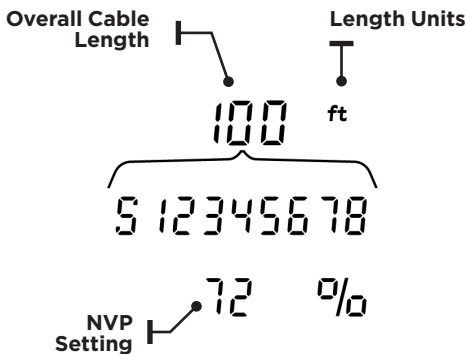

Length can be shown in units of either meters or feet.

## To set the length measurement units:

- Press the TOOLS/SAVE button repeatedly until either the **m** or **ft** symbol flashes.
- Press ▼ or ▲  
The length units change between meters and feet.
- Press the TOOLS/SAVE button repeatedly until the Setting Indicator disappears.

## To measure the cable length:

Connect the cable to the tester.

- The display shows the cable length. Press the port selection button of the currently selected port.

- The display changes to show the overall cable length or the length of an individual pair inside the cable.

Repeat to show the length of each pair or the overall length in turn.

- By investigating the individual pair lengths, cable faults and distance to fault can be found.
- The individual pairs are often different lengths and may be longer than the overall cable because of the internal twisted construction.



Length of Pair 1-2



Length of Pair 3-6

# VOLTAGE MEASUREMENT

If a voltage greater than approximately 2 volts is detected on any pin(s), cable testing and length measurement are not possible. Instead, PoE PRO displays information about the voltage(s) present and the type of service that those voltages indicate, where applicable.

The display shows the detected voltage and the pins on which it is present, together with polarity. Depending on the port and the voltages on the pins, the display also shows the type of service detected on the cable...

Port	Service	Voltage	Pins
Voice	PBX	>30v	3-4 or 2-5
Data	PoE	(See previous section)	
	PBX	>30v	4-5
	ISDN	>30v	3/6 - 4/5

**Example 1 -  
PBX service on  
VOICE port**

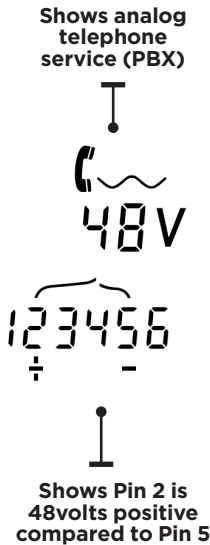

**Example 2 -  
ISDN service on  
DATA port**

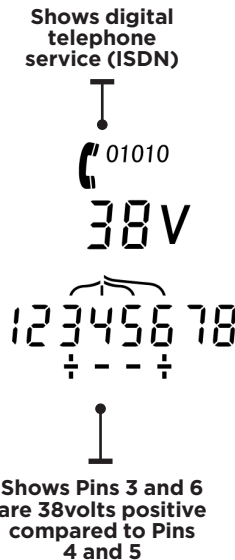

**Example 3 -  
Unknown service  
on DATA**

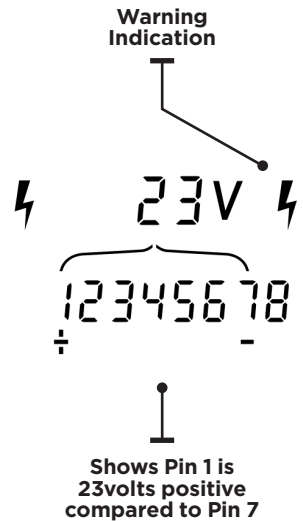

# tone generation

PoE PRO can be used together with a compatible tone probe (available from TREND NETWORKS) to identify and trace cables. PoE PRO can generate various types of tone on various combinations of pins. Choice of tone type and pin connection is best determined by experiment, to achieve the best results with a particular probe type and in a particular cable situation.

## To switch on the tone generation:

Press the TONE button.

- The currently selected tone type is generated on the currently selected pins of the currently selected port.
- Tone generation continues until switched off or for a maximum of 144 minutes.

## To change the port that the tone is applied to:

Press the relevant port selection button.

- The tone is applied to the selected port using the tone type and pin settings that were last used for that port.

## To change the pins that the tone is applied to:

Press the port selection button of the currently selected port.

- The pins that the tone is applied to change each time the button is pressed.

## To change the tone type:

Press the TONE button.

- The tone type changes each time the TONE button is pressed.

The tone generation can be controlled from the far end of the cable, to assist in confirming that the correct cable has been traced.

## To control the tone generation from the far end:

Briefly apply a short circuit between any two wires of the cable.

- The sound of the tone changes.

## To switch off the tone generation:

Press and hold the TONE button.

- The tone generation stops and normal cable testing is resumed.

Release the TONE button.

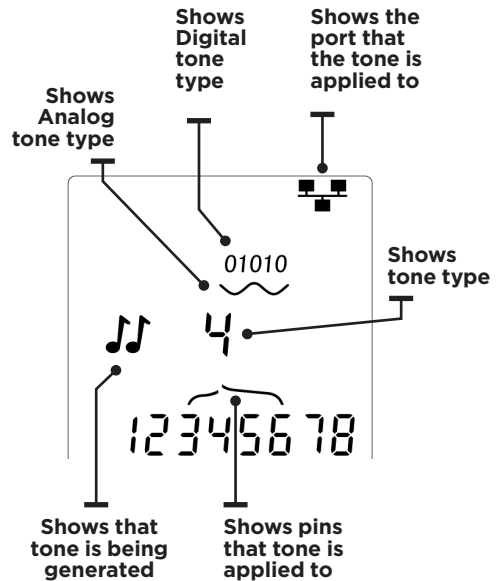

# HUB (PORT) BLINK

To assist in confirming correct cabling of Ethernet installations, PoE PRO can generate Ethernet signalling on one end of a cable which causes the port LED of the device connected to the other end to flash.

Hub (port) Blink is only available when the DATA port is selected.

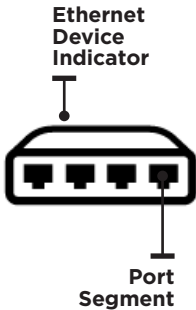

### To switch on Hub Blink:

Press the TOOLS/SAVE button repeatedly until the Ethernet Device Indicator flashes.

Press ▼ or ▲



- The ✓ symbol shows that Hub Blink is switched on.
- The Port Segment of the Ethernet Device Indicator blinks.
- Hub blinking continues until switched off or for a maximum of 144 minutes.

### To switch off Hub Blink:

Press the TOOLS/SAVE button

- The Ethernet Device Indicator Port Segment stops flashing.
- Hub Blink stops.

### NVP

		70
	RG59	82
	Cat 3	65
	Cat 5/5e/6/6A	72
	Cat 7	79



# USING POE PRO WITH THE TREND ANYWARE CLOUD APP

The PoE Pro tester can be used with the TREND AnyWARE Cloud App to store test results and upload them to TREND AnyWARE Cloud to generate reports.

## Process overview

- Download the TREND AnyWARE Cloud App from the Apple App Store or Google Play Store and sign-in to your AnyWARE Cloud account. New users can create a new account on the App.
- Pair the tester to the AnyWARE Cloud App.
- Connect the tester to the cable or network device to be tested and wait for the result.
- Send the currently displayed result to the AnyWARE Cloud App where the result is stored.
- Upload completed jobs to AnyWARE Cloud where results can be viewed and organized.
- Generate test reports of jobs or individual test results.

## Log-in or create a free account on TREND AnyWARE Cloud

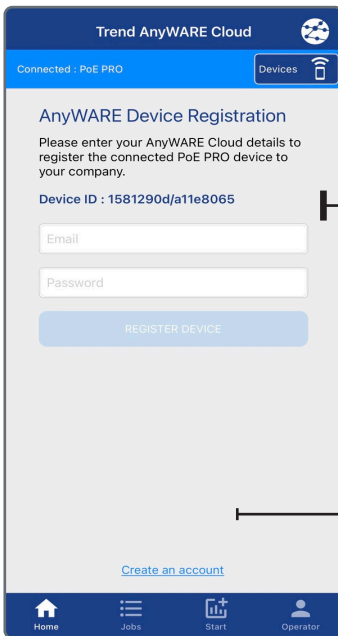

Register into existing account

Create a new AnyWARE account

The connected tester will be automatically registered to your AnyWARE account and all uploaded results will be sent to this account.

## Install the TREND AnyWARE Cloud App

- Visit the Apple App Store or Google Play Store and search for “Trend Anyware”. The app will be displayed with the TREND “connected dots” icon. 
- Launch the app on your mobile device and sign into your account using the same user name and password used to create your AnyWARE Cloud account.

**All test results saved by the PoE Pro will upload to the account used to log into the app. If you have an existing AnyWARE Cloud account and want the test results to upload to that account, enter the user name/password for that AnyWARE Cloud account.**

- Once logged in the app will default to the Home screen and begin searching for a PoE Pro tester.

## Pair tester to App

- Turn on the tester and ensure Bluetooth is turned on.
- Device with ID 41ff detected but not connected.
- Tap the device ID to pair with the App.

## Tester paired to App

When successfully connected to the App, a picture of the tester and its Device ID will be displayed on the Home Screen.

The tester is automatically registered to the AnyWARE Cloud account used to log in.



## Create a new job

- Press the Jobs button to open the Jobs screen.
- Press + to create a new job. Names can be up to 25 characters long. Up to 500 jobs can be saved in the App.
- Enter a name then press CREATE JOB.

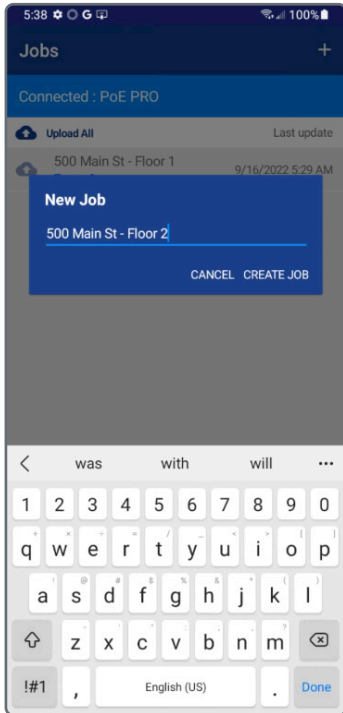

## Job list

The Jobs screen displays a list of jobs, the number of tests in each job, the upload status and the date/time of the last update.

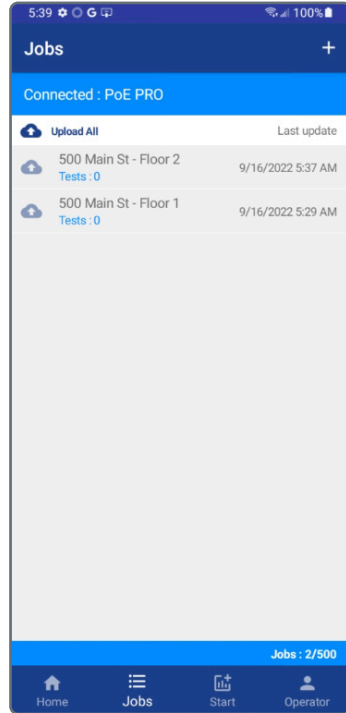

## Set Operator name

- Press the Operator button to set the name of the operator.
- The operator's name will appear on the test reports saved on the App.

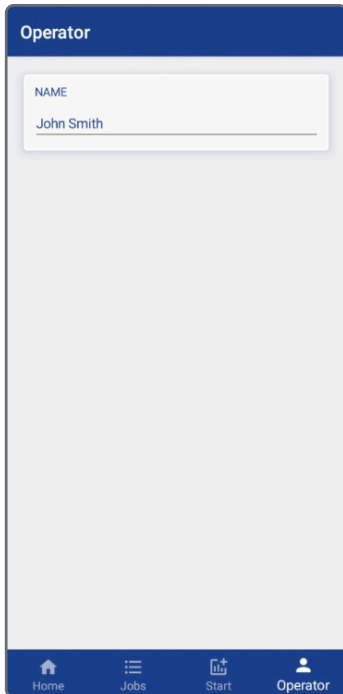

## Start Saving Tests

- Press the Start button to begin saving tests from the PoE Pro.
- Tap the Job name to select the Job where tests are saved.
- Enter the ID for the next test to be saved. The ID will auto-increment each time a new test is saved.
- Optionally enter text into the CABLE INFORMATION field. This text will appear on the report to identify the type of cable tested.
- An image can be added to the record before or after the test is saved, but before the job is uploaded to the Cloud. Press the + button to select an existing image from the phone or use the camera to take a new picture.

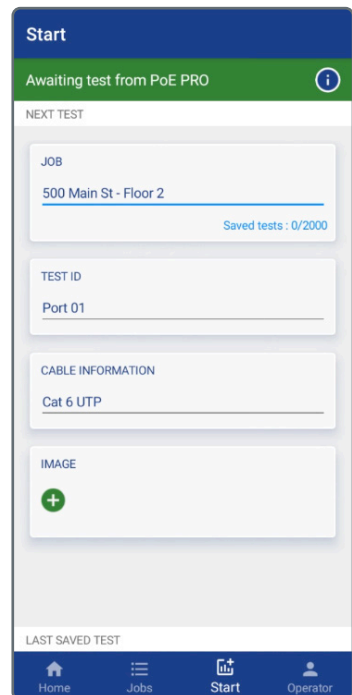

## Saving Tests to the AnyWARE App

- Connect the PoE Pro to the cable or PoE link to be tested and wait for the result to appear on the screen.
- Press the Save  button on the tester for 2 seconds. This will send the current test result to the App and save the record.
- The Test ID and Job name will be displayed on the App when the test is saved.
- The last digit/letter of the Test ID will increment and the App is ready to save a new test.

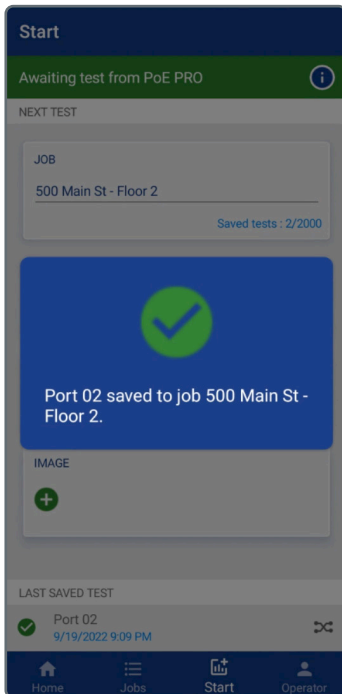

## Delete a Job

Swipe the Job name to the right to delete the Job.

Deleting a job permanently deletes the tests from the App. Upload tests remain on the Cloud when deleted from the App.

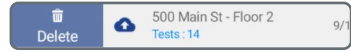

## Viewing Saved Results

- Tap Jobs to view the Job list. The list of Jobs displays the current number of tests stored in each Job.
- The blue cloud next to the Job name indicates a Job has not been uploaded to AnyWARE Cloud.
- Tap the Job name to view the tests stored in the Job.

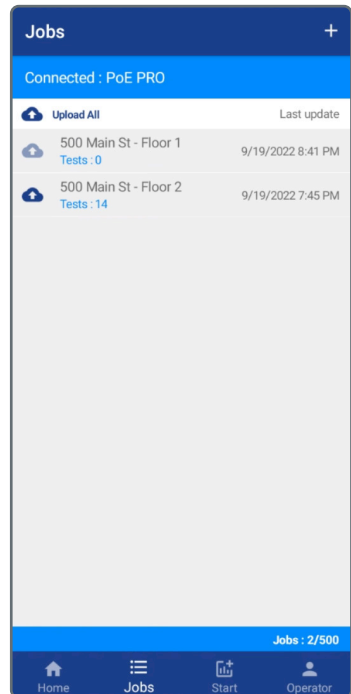

## Test List

- The test list displays the Test ID, date/time, type of test, and pass/fail result if applicable. Only wiremap and PoE tests display a pass/fail result.
- Tap the Test ID to view the test information

## Test Information

- Before a Job is uploaded to AnyWARE Cloud, only the test information, not the test results are available. After a Job is uploaded to AnyWARE Cloud, the results are processed and can be viewed on the AnyWARE App.
- Before uploading to AnyWARE Cloud the Test ID can be modified by tapping the edit button in the upper-right corner.
- Tap JOB to open the Job List and move the current test to a different job.
- Tap the + below IMAGE to add or change the image attached to the Test ID.
- Tap the waste bin in the bottom-right corner to delete the test.

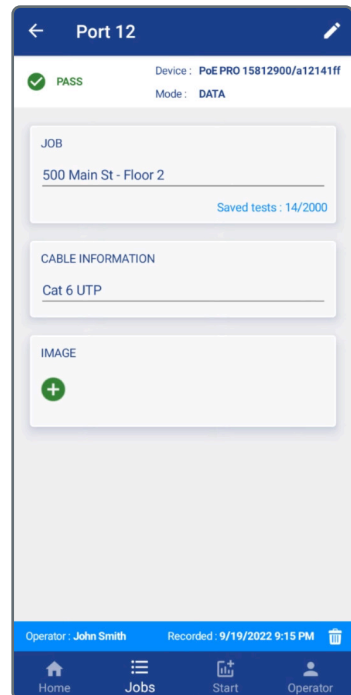
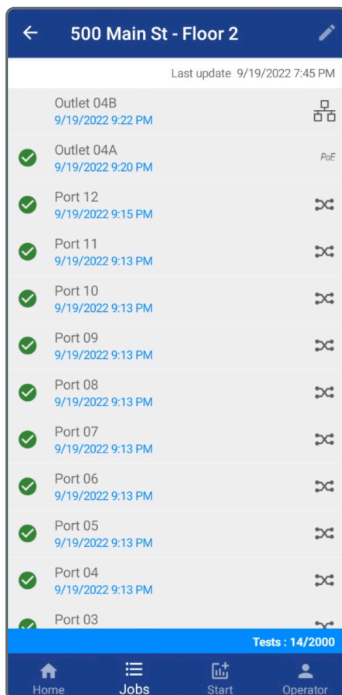

## Uploading Test to AnyWARE Cloud

- Tap the blue upload icon beside the Job name to upload only that Job to AnyWARE Cloud.
- Tap Upload All to upload all Jobs from the App to AnyWARE Cloud.
- A Wi-Fi or mobile data connection is required to upload results.

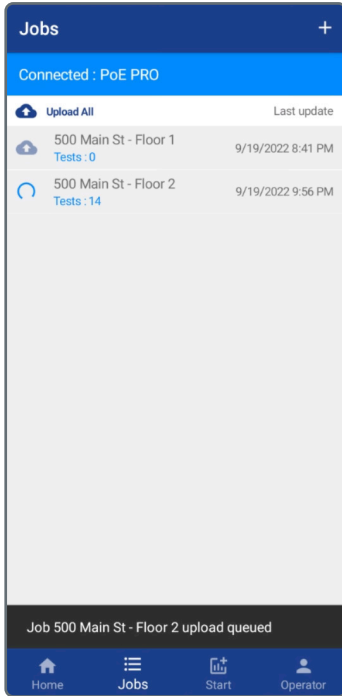

## Viewing Uploaded Test Results

- After a job is uploaded to AnyWARE Cloud the test results can be viewed on the App.
- The test results are read-only and cannot be modified once the tests have been uploaded to AnyWARE Cloud.

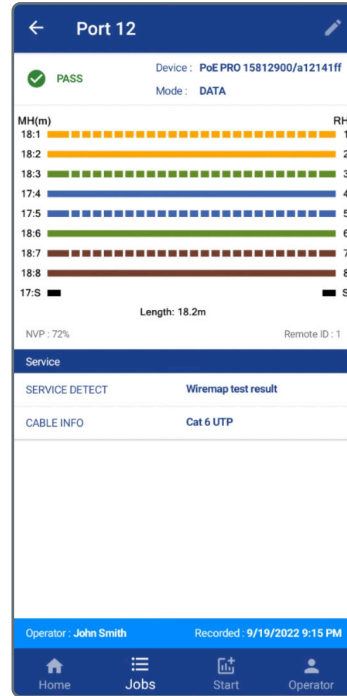

- After the Job is uploaded, the blue cloud will change to green which indicates all tests in the Job are uploaded.

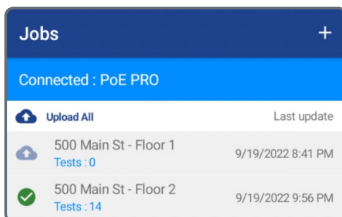

## Viewing Uploaded Test Results on AnyWARE Cloud

- Log into AnyWARE Cloud to view uploaded test results.  
www.anyware.trend-networks.com
- The Job Tree and list of Jobs is shown in the order of most recent at the top by default.

The screenshot shows the 'Jobs' page in the AnyWARE Cloud interface. On the left is a 'Jobs' tree with folders for '500 Main St - Floor 1', '500 Main St - Floor 2', 'Floor 3', 'Hanover', 'Central State College', 'Store 330', 'Store 328', and 'Archive'. The main area displays a list of jobs with summary statistics:

Job Name	Date	Network	Test Type	TOTAL	PASSED	FAILED	VIEW
500 Main St - Floor 1	19/09/2022	IDEAL Industries Networks	PoE PRO	24	0	0	VIEW
500 Main St - Floor 2	19/09/2022	IDEAL Industries Networks	PoE PRO	14	13	0	VIEW
Floor 3	12/09/2022	IDEAL Industries Networks	PoE PRO	7	5	0	VIEW
Hanover	24/08/2022	Test	LanTEK-IV Twisted Pair	0	0	0	VIEW

A 'LOAD MORE JOBS' button is located at the bottom of the job list.

- Click on the Job name in the tree or in the blue box to open the Job and view the test results.

The screenshot shows the details page for the job '500 Main St - Floor 1'. The left sidebar shows the job tree with '500 Main St - Floor 1' selected. The main area displays a table of test results:

Panel	Port	Date	Time	Duration	Data	Pass	Fail	Warn	Info
Panel A	Port 07	18/09/2022	10:14	19:00	DATA	-	-	-	-
Panel A	Port 08	18/09/2022	10:14	19:00	DATA	-	-	-	-
Panel A	Port 09	18/09/2022	10:14	19:00	DATA	-	-	-	-
Panel A	Port 10	18/09/2022	10:14	19:00	DATA	-	-	-	-
Panel A	Port 11	18/09/2022	10:14	19:00	DATA	-	-	-	-
Panel A	Port 12	18/09/2022	10:14	19:00	DATA	-	-	-	-
Panel B	Port 01	18/09/2022	10:14	19:00	DATA	-	-	-	-
Panel B	Port 02	18/09/2022	10:14	19:00	DATA	-	-	-	-
Panel B	Port 03	18/09/2022	10:14	19:00	DATA	-	-	-	-
Panel B	Port 04	18/09/2022	10:14	19:00	DATA	-	-	-	-
Panel B	Port 05	18/09/2022	10:14	19:00	DATA	-	-	-	-
Panel B	Port 06	18/09/2022	10:14	19:00	DATA	-	-	-	-

At the bottom, there are navigation buttons for 'PREVIOUS' and 'NEXT', and a status bar showing 'Page 1 of 1' and '50 Rows'.



## Viewing Uploaded Test Results on AnyWARE Cloud

- Click on a Test ID to open the detailed result.

The screenshot displays the TREND NETWORKS AnyWARE Cloud interface. The top navigation bar shows the job path: Jobs > 500 Main St - Floor 1 > Panel A Port 01. The main header area includes the location '500 Main St - Floor 1', the date '19/09/2022', and the device 'IDEAL Industries Networks PoE PRO'. Summary statistics show a total of 24 tests, with 24 passed and 0 failed. Below this, a green bar indicates the test status as 'PASS' for 'Panel A Port 01', which is 'Test 1 of 24'. A 'Summary' button is visible. The test details section shows the operator 'John Smith', device 'PoE PRO 15812900/a121411f', time '19/09/2022, 10:31', mode 'Data', and cable information 'Cat 6 UTP'. The 'Wiremap' section shows a diagram with 8 main ports (1-8) and 8 remote ports (1-8), with a length of 19.10 m and NVP of 72%. The 'Remote ID' field is empty. The status at the bottom is 'No Fault'.

## Organizing Tests into Structured Elements

- In the example below the Test IDs are labeled with a panel name and port number. Structured cabling components can be created in the job tree to organize test results into logical levels to improve organization of data.

The screenshot displays the TREND NETWORKS AnyWARE Cloud interface showing a list of test results. The left sidebar shows a job tree with the following structure: Jobs > 500 Main St - Floor 1 > 500 Main St - Floor 2 > Floor 3 > Hanover > Central State College > Store 330 > Store 328 > Archive. The main table lists test results for 'Panel A Port 07' through 'Panel A Port 12' and 'Panel B Port 01' through 'Panel B Port 06'. The table columns include Test ID, Date, Time, Duration, Data, and various status indicators. The bottom of the table shows 'Page 1 of 1' and '50 Rows'.

Test ID	Date	Time	Duration	Data	Status 1	Status 2	Status 3	Status 4	Status 5
Panel A Port 07	18/09/2022	10:14	19:00	DATA	-	-	-	-	-
Panel A Port 08	18/09/2022	10:14	19:00	DATA	-	-	-	-	-
Panel A Port 09	18/09/2022	10:14	19:00	DATA	-	-	-	-	-
Panel A Port 10	18/09/2022	10:14	19:00	DATA	-	-	-	-	-
Panel A Port 11	18/09/2022	10:14	19:00	DATA	-	-	-	-	-
Panel A Port 12	18/09/2022	10:14	19:00	DATA	-	-	-	-	-
Panel B Port 01	18/09/2022	10:14	19:00	DATA	-	-	-	-	-
Panel B Port 02	18/09/2022	10:14	19:00	DATA	-	-	-	-	-
Panel B Port 03	18/09/2022	10:14	19:00	DATA	-	-	-	-	-
Panel B Port 04	18/09/2022	10:14	19:00	DATA	-	-	-	-	-
Panel B Port 05	18/09/2022	10:14	19:00	DATA	-	-	-	-	-
Panel B Port 06	18/09/2022	10:14	19:00	DATA	-	-	-	-	-

## Adding Structured Cabling Components to the Job Tree

- Right-click on the Job name to which the component will be added.
- Click on Add, then select the component to add below the Job name.

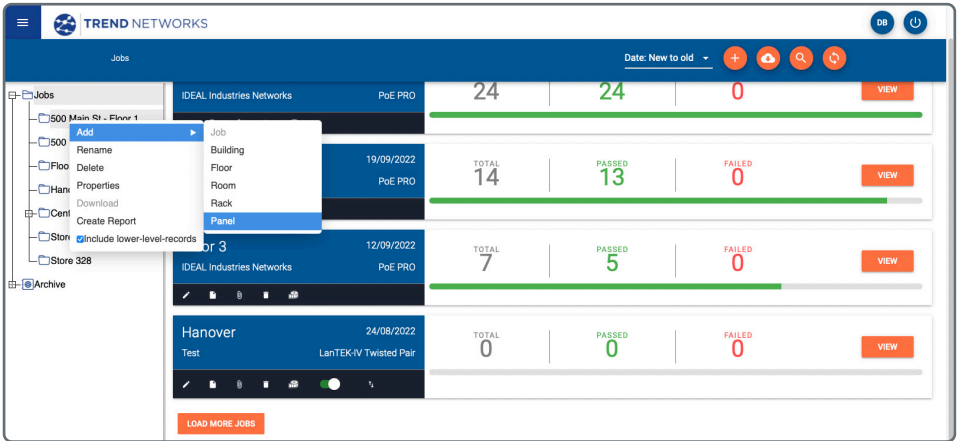

- Type the name of the new Element and Click SAVE or press Enter.  
Repeat the process as needed to create the desired structured cabling component tree.

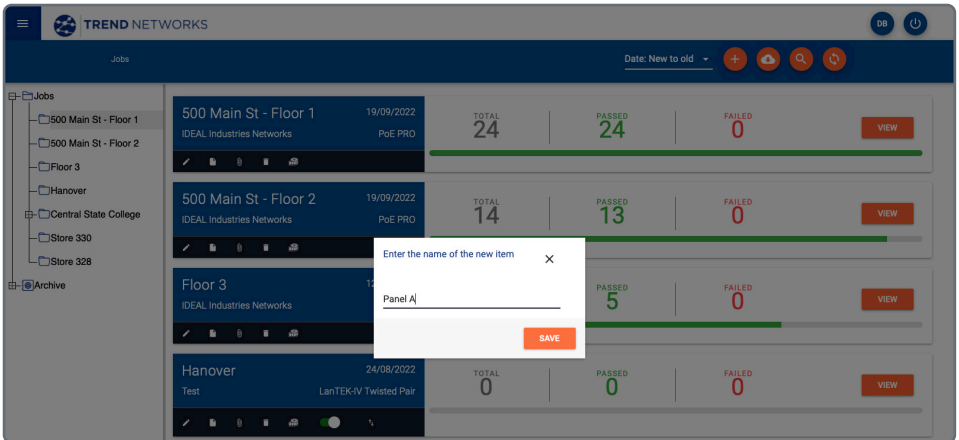

*Note: Elements can be nested in the order from largest to smallest. Example, a Panel can be created below a Building. A Building cannot be created below a Panel.*

## Organizing Tests into Components

- Select the tests to move by either clicking the selection box beside each test to move.
- To select a range of tests, click the selection box of the first test, hold SHIFT, then click the selection box of the last test to select the tests in between.
- Click and drag the multi-test selector icon to the component where the tests are to be moved.

	Test Name	Date	Time	Length (m)	Mode	Link Speed	PoE Class	PoE Watts	PoE Volts (0...	PoE Volts (C
<input checked="" type="checkbox"/>	Panel A Port 01	18/09/2022	10:31	19:10	DATA	-	-	-	-	-
<input checked="" type="checkbox"/>	Panel A Port 02	18/09/2022	10:31	19:10	DATA	-	-	-	-	-
<input checked="" type="checkbox"/>	Panel A Port 03	18/09/2022	10:31	18:30	DATA	-	-	-	-	-
<input checked="" type="checkbox"/>	Panel A Port 04	18/09/2022	10:31	18:30	DATA	-	-	-	-	-
<input checked="" type="checkbox"/>	Panel A Port 05	18/09/2022	10:31	18:30	DATA	-	-	-	-	-
<input checked="" type="checkbox"/>	Panel A Port 06	18/09/2022	10:31	18:30	DATA	-	-	-	-	-
<input checked="" type="checkbox"/>	Panel A Port 07	18/09/2022	10:31	18:30	DATA	-	-	-	-	-
<input checked="" type="checkbox"/>	Panel A Port 08	18/09/2022	10:31	18:40	DATA	-	-	-	-	-
<input checked="" type="checkbox"/>	Panel A Port 09	18/09/2022	10:31	18:40	DATA	-	-	-	-	-
<input checked="" type="checkbox"/>	Panel A Port 10	18/09/2022	10:31	18:40	DATA	-	-	-	-	-
<input checked="" type="checkbox"/>	Panel A Port 11	18/09/2022	10:31	18:40	DATA	-	-	-	-	-
<input checked="" type="checkbox"/>	Panel A Port 12	18/09/2022	10:31	18:40	DATA	-	-	-	-	-
<input type="checkbox"/>	Panel B Port 01	18/09/2022	10:32	18:40	DATA	-	-	-	-	-
<input type="checkbox"/>	Panel B Port 02	18/09/2022	10:32	18:40	DATA	-	-	-	-	-

- Click and drag the multi-test selector icon to the component where the tests are to be moved.
- The tests will move into the new component and the black header bar will display the name of the component where the tests are located.

	Test Name	Date	Time	Length (m)	Mode	Link Speed	PoE Class	PoE Watts	PoE Volts (0...	PoE Vol
<input type="checkbox"/>	Panel A Port 01	18/09/2022	10:31	19:10	DATA	-	-	-	-	-
<input type="checkbox"/>	Panel A Port 02	18/09/2022	10:31	19:10	DATA	-	-	-	-	-
<input type="checkbox"/>	Panel A Port 03	18/09/2022	10:31	18:30	DATA	-	-	-	-	-
<input type="checkbox"/>	Panel A Port 04	18/09/2022	10:31	18:30	DATA	-	-	-	-	-
<input type="checkbox"/>	Panel A Port 05	18/09/2022	10:31	18:30	DATA	-	-	-	-	-
<input type="checkbox"/>	Panel A Port 06	18/09/2022	10:31	18:30	DATA	-	-	-	-	-

## Creating Test Reports

Note: At least one customer must be created in the account to generate a test report. Use the menu button in the upper-left corner and select Customers to add customers to the account.

- Create a report of all the tests in a Job or in a Component by right-clicking on the selection to be reported. If Include lower level records is selected, all of the tests in components at a lower level of the selected component will be in the report.
- Create a report of individual tests by selecting the boxes beside each test then click the orange report icon at the top of the screen.

The screenshot displays the Trend Networks web interface. The main header shows the job title '500 Main St - Floor 1' and 'IDEAL Industries Networks'. Statistics are displayed as follows:

Category	Value
TOTAL	24
PASSED	24
FAILED	0
Selected	0

A context menu is open over the '500 Main St - Floor 1' component, with 'Create Report' selected. Below the menu, a table lists test results:

Test Name	Date	Time	Length (m)	Mode	Link Speed	PoE Class	PoE Watts	PoE Volts (O...)	PoE Volt
Panel A Port 01	18/09/2022	10:31	19.10	DATA	-	-	-	-	-
Panel A Port 02	18/09/2022	10:31	19.10	DATA	-	-	-	-	-
Panel A Port 03	18/09/2022	10:31	18.30	DATA	-	-	-	-	-
Panel A Port 04	18/09/2022	10:31	18.30	DATA	-	-	-	-	-
Panel A Port 05	18/09/2022	10:31	18.30	DATA	-	-	-	-	-
Panel A Port 06	18/09/2022	10:31	18.30	DATA	-	-	-	-	-
Panel A Port 07	18/09/2022	10:31	18.30	DATA	-	-	-	-	-
Panel A Port 08	18/09/2022	10:31	18.40	DATA	-	-	-	-	-
Panel A Port 09	18/09/2022	10:31	18.40	DATA	-	-	-	-	-
Panel A Port 10	18/09/2022	10:31	18.40	DATA	-	-	-	-	-

Enter the name of the test report. The default name is the Component that was selected when Create Report was selected. Edit the name if necessary and click CONTINUE to complete the remaining report options.

### CREATE A REPORT ✕

**REPORT DETAILS**    CUSTOMER DETAILS    REPORT OPTIONS

Report Name\*  
**500 Main St - Floor 1**

Please Enter Report Name

Report Type\*  
**Mobile**

Please Select Report Type

Job Name  
**500 Main St - Floor 1**

Report Tests  
**12 Tests Selected**

**CONTINUE**





## View Test Reports

- Click the menu button in the upper-left corner .
- Click Reports to view available reports in your AnyWARE Cloud account

### NAVIGATION ✕

 Jobs



ADMINISTRATION

-  User Accounts
-  Customers
-  Devices
-  Reports
-  Default Sub Test Settings

 Help

 Support

### Reports

<input type="checkbox"/>	Name	Type	Status	Customer Name	Total Tests	File Size	Time	Created at
<input type="checkbox"/>	500 Main St - Floor 1 Panel B	Mobile	Completed	 City Tower	12	4111KB	00:03	26/09/2022, 14:47
<input type="checkbox"/>	500 Main St - Floor 1 Panel A	Mobile	Completed	 City Tower	11	3769KB	00:03	26/09/2022, 14:47

Click the  icon to open a PDF of the report in a new browser tab.

*Note: Pop-up blockers may attempt to prevent the new tab from opening.*

## Emailing Reports

- Select one or more reports by clicking the tick-box beside the report name.
- Click the  icon and type in one or more email addresses separated by a semi-colon. AnyWARE Cloud will send an email to each recipient with a link to download the report.

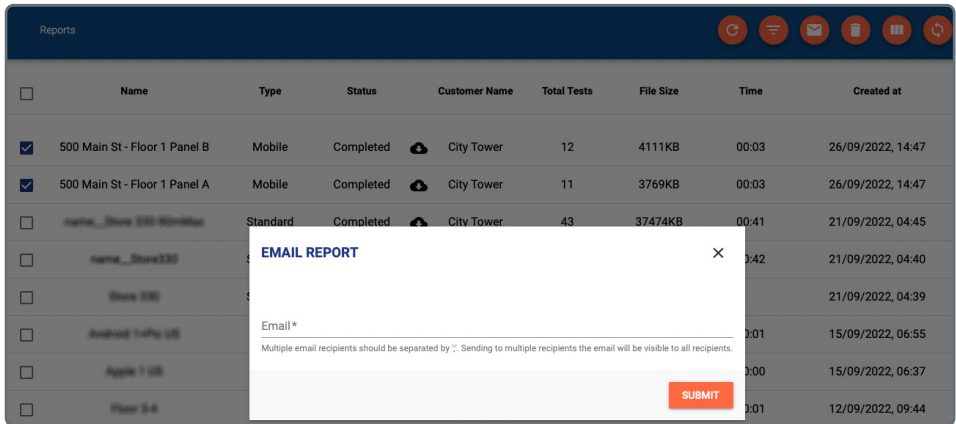

The screenshot shows the 'Reports' section of the AnyWARE Cloud interface. A table lists various reports with columns for Name, Type, Status, Customer Name, Total Tests, File Size, Time, and Created at. Two reports are selected with checkmarks. An 'EMAIL REPORT' modal dialog is open, prompting for an email address. The dialog includes a 'SUBMIT' button and a note: 'Multiple email recipients should be separated by ";". Sending to multiple recipients the email will be visible to all recipients.'

Name	Type	Status	Customer Name	Total Tests	File Size	Time	Created at
<input checked="" type="checkbox"/> 500 Main St - Floor 1 Panel B	Mobile	Completed	City Tower	12	4111KB	00:03	26/09/2022, 14:47
<input checked="" type="checkbox"/> 500 Main St - Floor 1 Panel A	Mobile	Completed	City Tower	11	3769KB	00:03	26/09/2022, 14:47
<input type="checkbox"/> name_Store 220-Wireless	Standard	Completed	City Tower	43	37474KB	00:41	21/09/2022, 04:45
<input type="checkbox"/> name_Store230							21/09/2022, 04:40
<input type="checkbox"/> Store 230							21/09/2022, 04:39
<input type="checkbox"/> Android 1-Info-125							15/09/2022, 06:55
<input type="checkbox"/> Apple 1-125							15/09/2022, 06:37
<input type="checkbox"/> Floor 2-4							12/09/2022, 09:44

## Removing Tester from AnyWARE Account

To use a PoE Pro tester with a different AnyWARE Cloud account it must first be deleted from the current account.

- Click  and select Devices.
- Select the tester to delete and click the waste basket icon to remove the device from the account.

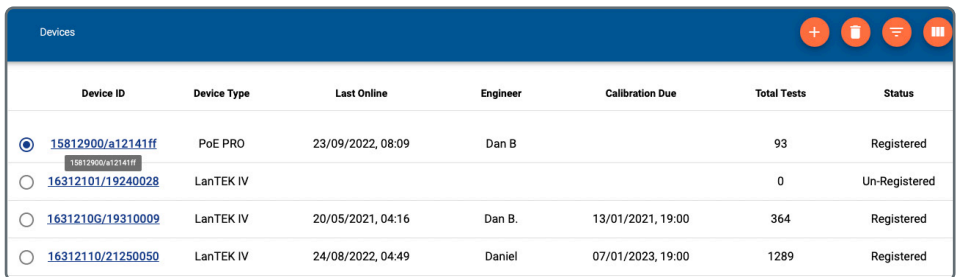

The screenshot shows the 'Devices' section of the AnyWARE Cloud interface. A table lists various devices with columns for Device ID, Device Type, Last Online, Engineer, Calibration Due, Total Tests, and Status. The first device is selected with a radio button.

Device ID	Device Type	Last Online	Engineer	Calibration Due	Total Tests	Status
<input checked="" type="radio"/> <a href="#">15812900/a12141ff</a>	PoE PRO	23/09/2022, 08:09	Dan B		93	Registered
<input type="radio"/> <a href="#">16312101/19240028</a>	LanTEK IV				0	Un-Registered
<input type="radio"/> <a href="#">16312106/19310009</a>	LanTEK IV	20/05/2021, 04:16	Dan B.	13/01/2021, 19:00	364	Registered
<input type="radio"/> <a href="#">16312110/21250050</a>	LanTEK IV	24/08/2022, 04:49	Daniel	07/01/2023, 19:00	1289	Registered



**TREND NETWORKS**

All Rights Reserved. TREND, TREND NETWORKS, the Connected Dot Device and the PoE PRO logos are trademarks or registered trademarks of TREND NETWORKS.

**TREND NETWORKS**

Stokenchurch House, Oxford Road, Stokenchurch  
High Wycombe, Buckinghamshire, HP14 3SX  
United Kingdom

Tel. +44 (0)1925 428 380 | Fax. +44 (0)1925 428 381

[www.trend-networks.com](http://www.trend-networks.com)

Specification subject to  
change without notice. E&OE  
© TREND Networks 2022  
158835 Rev.1