

C.A 10101



pH-meter







Measure up



Thank you for purchasing this **C.A 10101 pH-meter**.

For best results with your instrument:

- **read** these operating instructions carefully,
- **comply** with the precautions for use.

	Information or useful tip.
	Battery.
	Earth.
	The product is declared recyclable following an analysis of the life cycle in accordance with standard ISO 14040.
	Chauvin Arnoux has adopted an Eco-Design approach in order to design this appliance. Analysis of the complete life-cycle has enabled us to control and optimize the effects of the product on the environment. In particular this appliance exceeds regulation requirements with respect to recycling and reuse.
	The CE marking indicates conformity with European directives, in particular LVD and EMC.
	The rubbish bin with a line through it indicates that, in the European Union, the product must undergo selective disposal in compliance with Directive WEEE 2012/19/EU. This equipment must not be treated as household waste.

PRECAUTIONS FOR USE

This instrument is compliant with safety standard IEC 61010-2-030, for voltages 5V with report to ground. Failure to observe the safety instructions may result in electric shock, fire, explosion, and destruction of the instrument and of the installations.

- The operator and/or the responsible authority must carefully read and clearly understand the various precautions to be taken in use. Sound knowledge and a keen awareness of electrical hazards are essential when using this instrument.
- Observe the conditions of use, namely the temperature, the relative humidity, the altitude, the degree of pollution, and the place of use.
- Do not use the instrument if it seems to be damaged, incomplete, or poorly close.
- Before each use, check the condition of the housing. Any item of which the insulation is deteriorated (even partially) must be set aside for repair or scrapping.
- All troubleshooting and metrological checks must be done by competent, accredited personnel.
- Keep your electrode in a bottle containing an electrolytic solution.

CONTENTS

1. FIRST USE	4
1.1. Delivery condition	4
1.2. Accessories	5
1.3. Replacement parts	5
1.4. Inserting the batteries	6
2. PRESENTATION OF THE INSTRUMENT	7
2.1. C.A 10101	7
2.2. Functions of the instrument	8
2.3. Keypad	8
2.4. Display	9
2.5. Setting the time	9
2.6. Prop	10
3. USE IN STAND-ALONE MODE	11
3.1. pH measurement	11
3.2. Oxidation reduction potential measurement (ORP)	17
3.3. Recording the measurements	20
3.4. Errors	21
4. USE IN RECORDING MODE	22
4.1. Connection	22
4.2. Get Data Logger Transfer software	22
4.3. USB link	22
4.4. Data Logger Transfer software	25
5. TECHNICAL CHARACTERISTICS	28
5.1. Reference conditions	28
5.2. Characteristics	28
5.3. Memory	30
5.4. USB	30
5.5. Power supply	30
5.6. Environmental conditions	31
5.7. Mechanical characteristics	32
5.8. Compliance with international standards	32
5.9. Electromagnetic compatibility (EMC)	32
6. MAINTENANCE	33
6.1. Cleaning	33
6.2. Replacement of batteries	34
6.3. Serial number	34
6.4. Calibration log	34
6.5. Embedded software version	34
6.6. Updating the embedded software	34
7. WARRANTY	37

1. FIRST USE

1.1. DELIVERY CONDITION

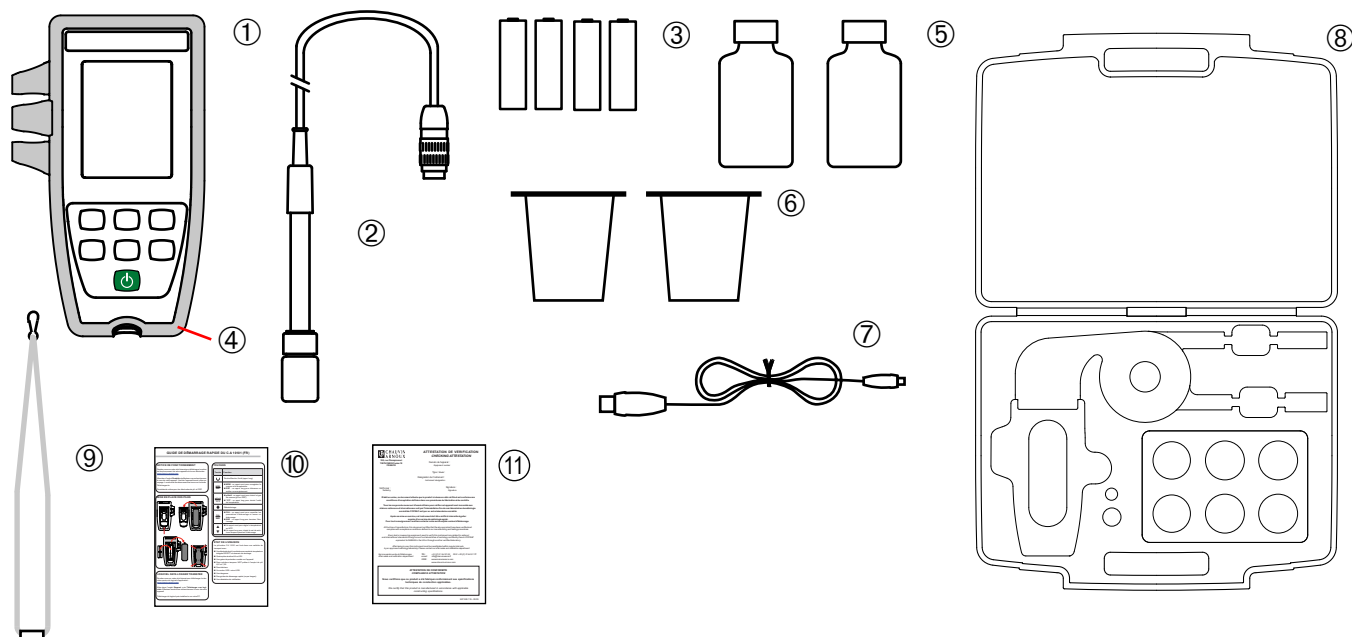

- ① One C.A 10101 pH-meter.
- ② One XRGST1 combined pH electrode with integrated temperature probe and storage reservoir.
- ③ Four AA or LR6 alkaline batteries.
- ④ One protective sheath fitted on the instrument.
- ⑤ Two ready-to-use buffer solutions, pH 4.01 and 7.00 (NIST = National Institute of Standards and Technology, United States).
- ⑥ Two beakers.
- ⑦ One USB to micro USB cable.
- ⑧ One carrying case.
- ⑨ One wrist strap.
- ⑩ Quick start guides (one per language).
- ⑪ One certificate of verification.

1.2. ACCESSORIES

- One XRPTST1 combined ORP electrode with integrated temperature probe and storage bottle.

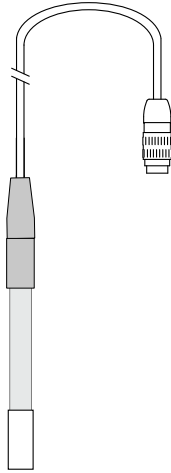

- One adapter, DIN male to S7 female (for the electrode) and female jack (for a PT1000 temperature probe). The cable is 1m long.

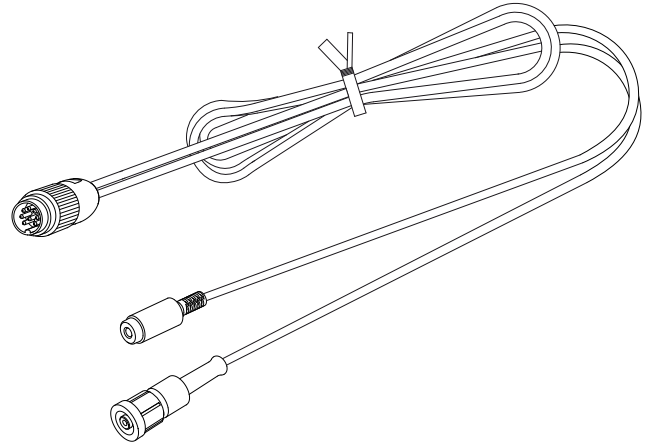

- One adapter DIN male to BNC female (for the electrode) and female jack (for a PT1000 temperature probe). The cable is 10cm long.

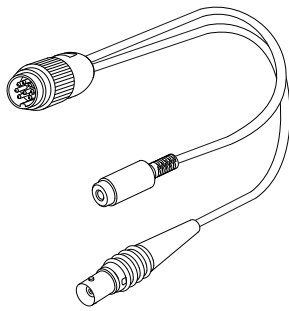

- One USB power adapter with USB to micro USB cable

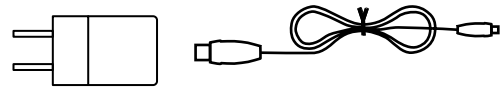

- One pH 1.68 buffer solution (NIST).
- One pH 9.18 buffer solution (NIST).
- One pH 10.01 buffer solution (NIST).
- One pH 4.005 buffer solution (Cofrac certified).
- One pH 6.865 buffer solution (Cofrac certified).
- One pH 9.180 buffer solution (Cofrac-certified).
- One 220mV ORP buffer solution
- One 468mV ORP buffer solution

1.3. REPLACEMENT PARTS

- One XRGST1 combined pH/temperature electrode
- One pH 4.01 buffer solution (NIST)
- One pH 7.00 buffer solution (NIST)
- One set of 3 plastic beakers
- One protecting sheath
- Electrode storage liquid (3 mol/L KCl)

For the accessories and spares, consult our web site:
www.chauvin-arnoux.com

1.4. INSERTING THE BATTERIES

- Turn the instrument over.
- Press the locking tab and lift off the battery compartment cover.

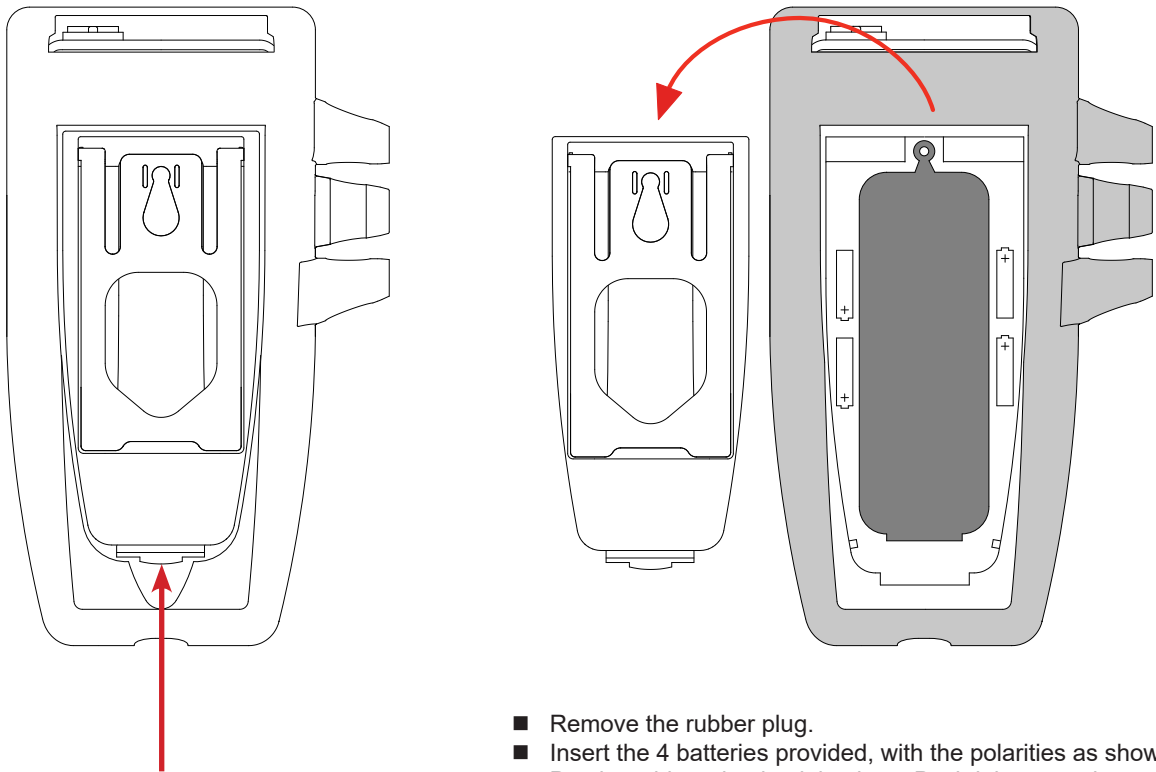

- Remove the rubber plug.
- Insert the 4 batteries provided, with the polarities as shown.
- Put the rubber plug back in place. Push it in correctly. Place the two front ends before pushing in the central part.
- Put the battery compartment cover back in place; make sure that it is completely and correctly closed.

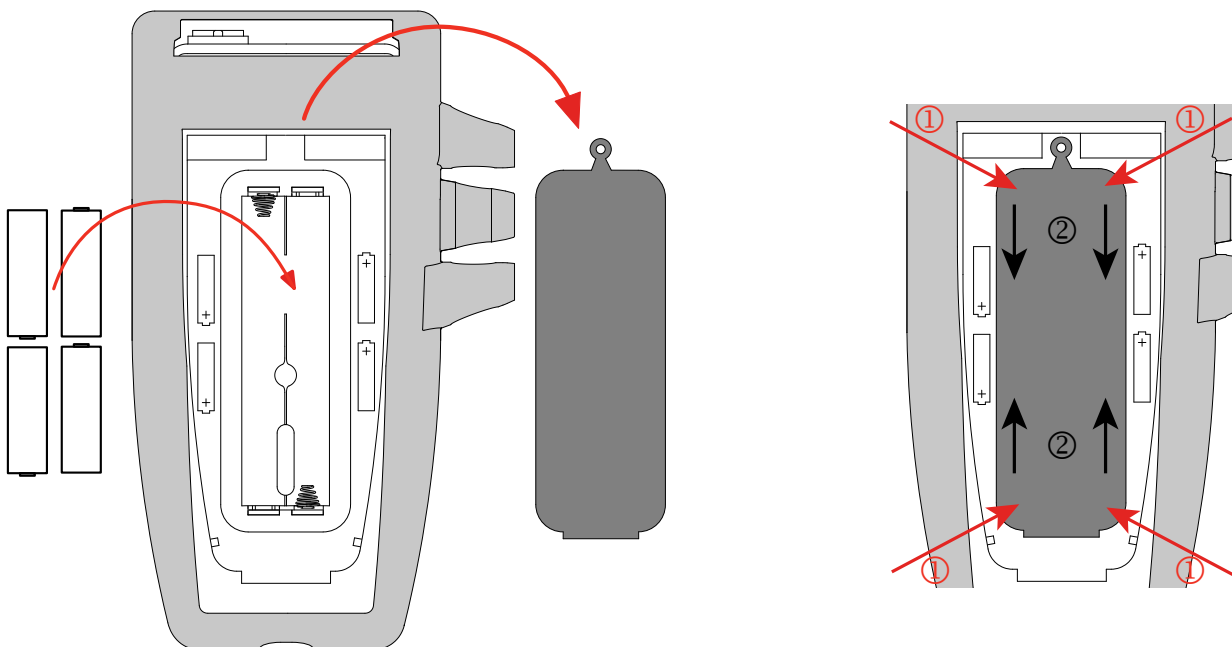

2. PRESENTATION OF THE INSTRUMENT

2.1. C.A 10101

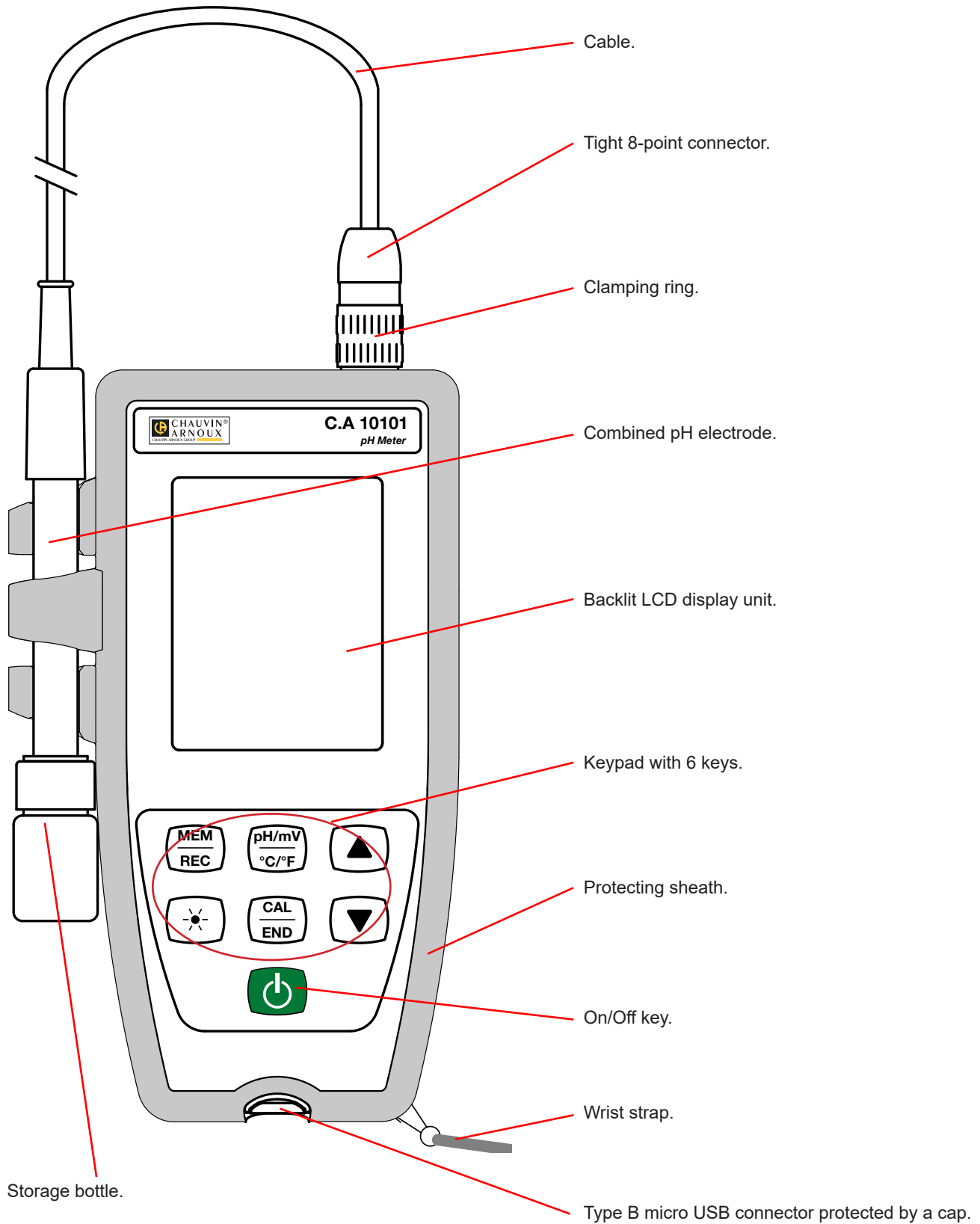

2.2. FUNCTIONS OF THE INSTRUMENT

The C.A 10101 is a pH-meter in a watertight housing. It can be used to measure pH, temperature, and oxidation reduction potential (ORP), depending on which electrode is connected.

This instrument is easy to use. It has extensive stand-alone capabilities and can be used:

- to calibrate the electrode using a set of buffer solutions,
- to automatically identify the pH buffer solution,
- to display temperature measurements in °C or in °F,
- to display the time,
- to record the measurements,
- to communicate with a PC via a USB cable.







The Data Logger Transfer software can be installed on a PC and is used to configure the instruments, to program a recording session and to recover the recorded measurements.

2.3. KEYPAD

The functions indicated above the line on the keys are accessed by a short press.

The functions indicated below the line are accessed by a long press.

To prevent inadvertently switching the instrument on, the  On/Off key requires a long press.

Key	Function
	<ul style="list-style-type: none"> ■ A long press on the  key switches the instrument on. ■ A second long press on the  key switches the instrument off when it is on. The instrument cannot be switched off while it is recording.
<u>MEM</u> REC	<ul style="list-style-type: none"> ■ A short press on the MEM key records the measurement and the temperature. ■ A long press on the REC key starts or stops a manual recording session.
<u>pH/mV</u> °C/°F	<ul style="list-style-type: none"> ■ A short press on the pH/mV key selects the type of measurement (pH or ORP) that matches the electrode connected. ■ A long press on the °C/°F key selects display of the temperature measurement in °C or in °F.
	A short press on the  key toggles the backlighting on and off. Once lit, it goes off after 30 seconds.
<u>CAL</u> END	<ul style="list-style-type: none"> ■ A short press on the CAL key is used to look up the current calibration and start the calibration procedure for the cell connected. ■ A long press on the END key is used to terminate the calibration procedure in progress.
 	<ul style="list-style-type: none"> ■ A short press on the ▲ or ▼ key is used to set the temperature in manual mode. ■ During the calibration, a long press on the ▲ or ▼ key selects the calibration set.

2.4. DISPLAY

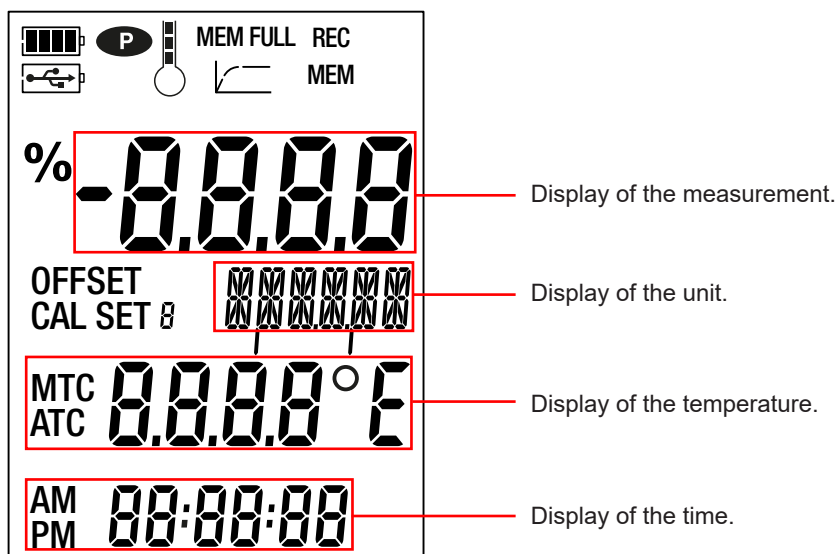

	Indicates the battery voltage level. When the symbol is empty, the batteries must be replaced.
	Indicates that the instrument is connected to a PC via the USB cable or that the power adapter is connected.
	Indicates that auto-off is disabled and the instrument is in permanent mode. This occurs when: <ul style="list-style-type: none"> ■ a calibration is in progress, ■ a recording is in progress, ■ the instrument is connected via the USB cable, ■ auto off is deactivated (see §4.4.3).
	Indicates the quality of the last electrode calibrated.
MEM FULL	When lit steadily, indicates that the instrument's memory is full. When blinking, indicates that the instrument's memory is 90% full.
	Indicates the progress of the measurement. When all segments are lit, the measurement is stable. When blinking, indicates that the measurement is over or that the calibration has been applied.
REC	When lit steadily, indicates that recording is in progress. When blinking, indicates waiting for the start of a recording session.
MEM	Indicates that a measurement is recorded.
%	Indicates the slope of the electrode.
OFFSET	Indicates the offset of the electrode.
CAL SET	Indicates that calibration is in progress.
MTC	Indicates that temperature compensation is manual.
ATC	Indicates that temperature compensation is automatic.

When the measurement exceeds the limits (whether positive or negative), the instrument displays **OL**.

2.5. SETTING THE TIME

The time of your instrument is set using the Data Logger Transfer software. Refer to §4.4.2.

2.6. PROP

To make reading easier, the instrument can be set on its prop.

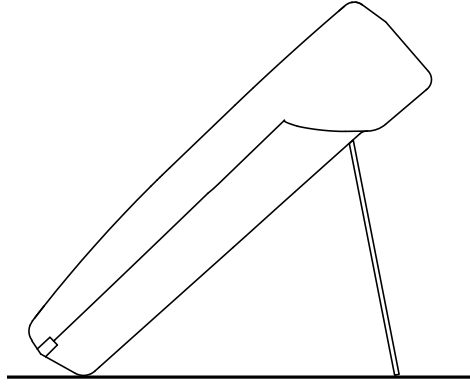

3. USE IN STAND-ALONE MODE

The instrument can operate in two modes:

- the stand-alone mode described in this section,
- the record mode, in which it is controlled by a PC. This mode is described in the next section.



In order to ensure proper operation of the instrument, always leave the electrode connected and the cap on the USB connector closed.



Keep your electrode in a bottle containing an electrolytic solution. Never keep the electrode in distilled or de-ionized water.

3.1. PH MEASUREMENT

3.1.1. FIRST USE

During the first use, connect the pH electrode supplied to the measuring instrument. Connect the connector of the electrode to the instrument and screw the ring tight.

3.1.2. CALIBRATION

The C.A 10101 is delivered with two buffer solutions (NIST), pH 4.01 and 7.00.

You can calibrate at one point, two points, or three points. Two solutions are provided with the instrument, the third is an option.

- Remove the storage bottle from the electrode.
- Rinse the electrode in de-ionized water, then dry it.

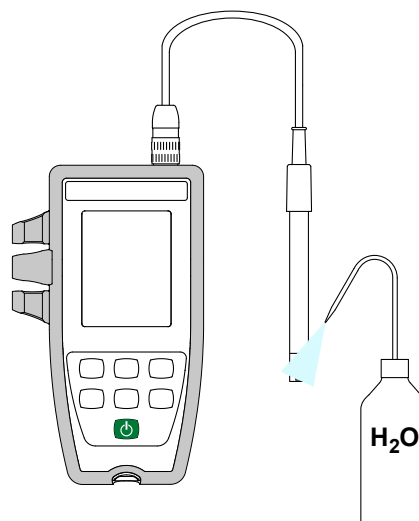
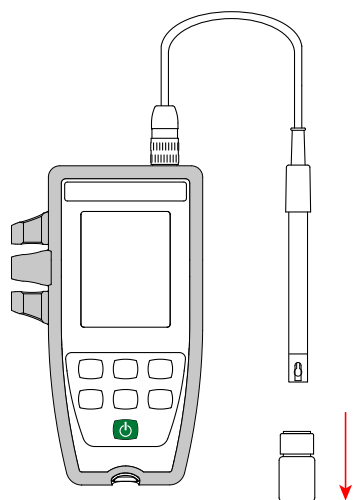

- Pour each buffer solution (one, two, or three depending on the number of calibration points) into a beaker. The third buffer solution (NIST, pH 9.18) is an option.
- Long-press the  key to switch the instrument on.

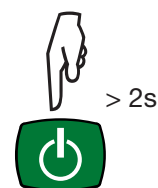
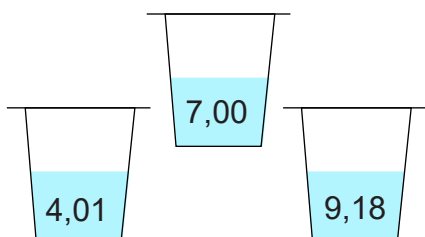

- If you spot an air bubble on the glass membrane, shake the electrode to eliminate it.
- Plunge the end of the electrode in the first buffer solution.

i Take care to completely submerge the glass ball and the salt bridge in the solution.

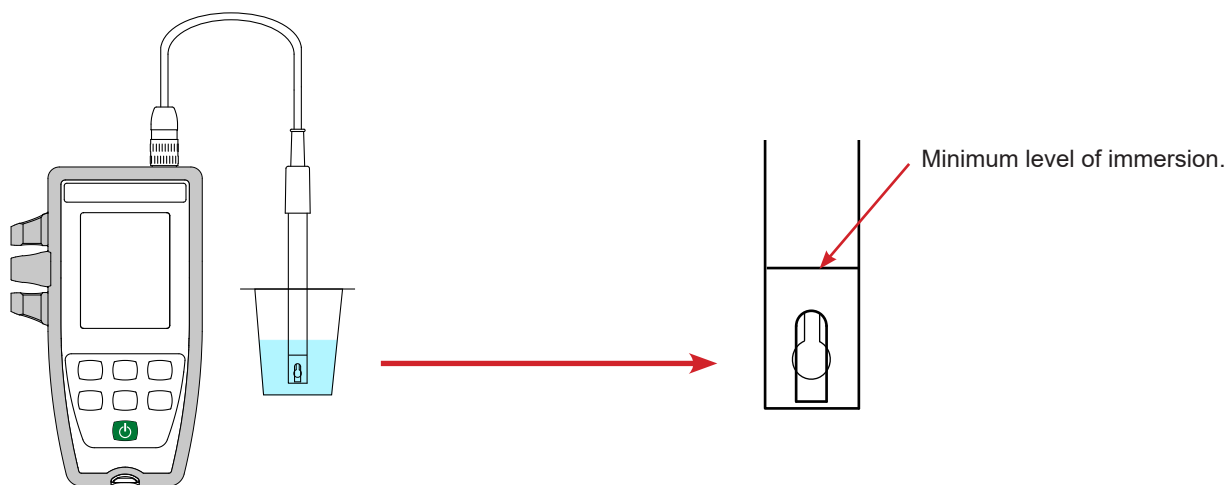

The electrode supplied with the instrument has an integrated temperature probe. There is therefore no need to measure the temperature of the solution.

- The instrument displays the pH and temperature measurements and the time.
ATC = Automatic Temperature Compensation
- Press the CAL key.
The instrument briefly displays the current calibration values (the slope in % and the offset in mV).

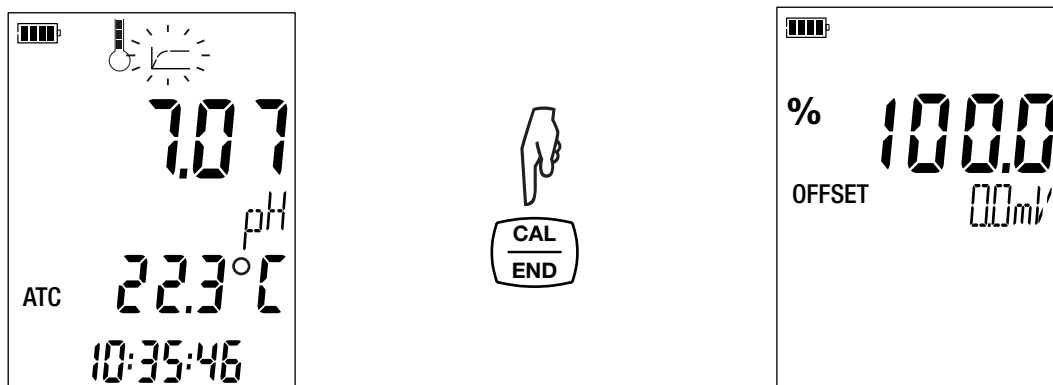

It then proposes selecting the calibration set. Three sets are available.

	pH at 25°C			
Calibration set 1	4.01	7.00	9.18	
Calibration set 2	1.68	4.01	7.00	10.01
Calibration set 3	4.005	6.865	9.180	

Calibration set 3 contains the Cofrac-certified buffer solution pH values.

If you have your own calibration set, you can change these values in the pH_Set.csv file (see §4.3).

- Choose the calibration set by long presses on the ▲ and ▼ keys. The values of the buffer solutions supplied are in set 1.

- Confirm the set by pressing the **CAL** key. When the instrument detects the buffer solution value, it displays it, corrected for temperature, in alternation with the temperature.

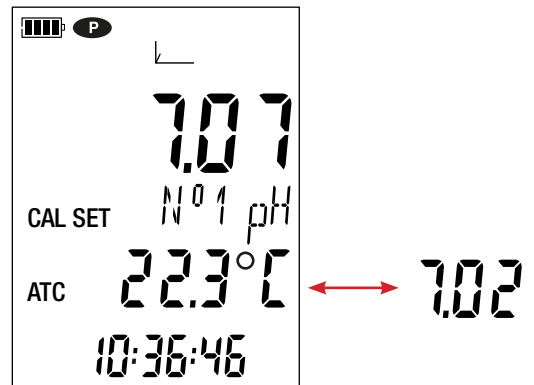
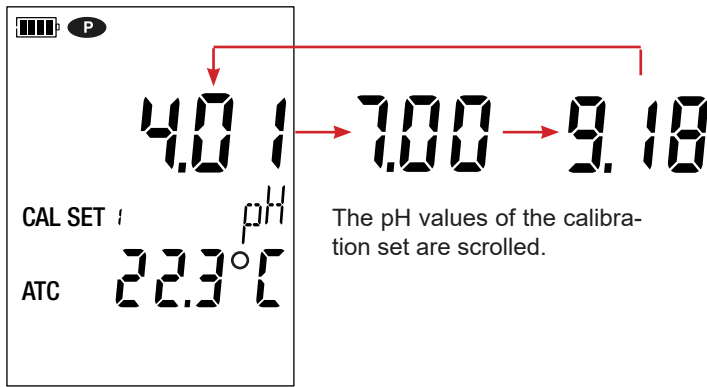

The instrument performs the pH measurement and indicates its progress.

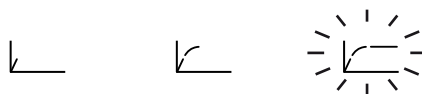

i Do not withdraw the electrode from the solution until the measurement is over.

If you want to abort the calibration of the electrode, long-press the **END**, key before the end of the measurement.

Otherwise, when the measurement has stabilized , the first calibration point is applied. The instrument then informs you that you can calibrate a second point.

The value of the buffer solution of the calibration set is always displayed in alternation with the temperature. The **CAL** and **END** symbols are also displayed in alternation, indicating that you can continue or terminate the calibration.

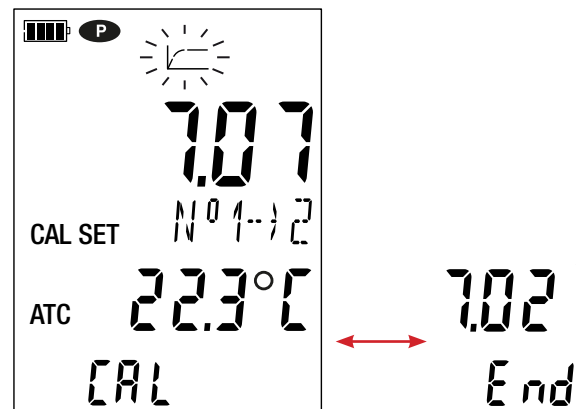

- If you need only one calibration point, long-press the **END** key. Only the offset of the electrode will be calculated; the slope will be left unchanged. The instrument exits from the calibration procedure and briefly displays the slope and the offset before switching back to measurement mode.

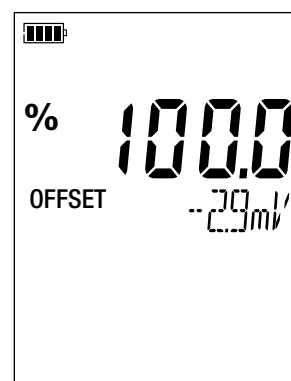
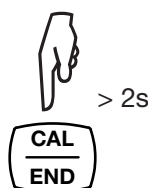

- If you want to continue the calibration, withdraw the electrode from the solution, rinse it with de-ionized water, dry it, plunge it in the second buffer solution, and press the **CAL** key again.

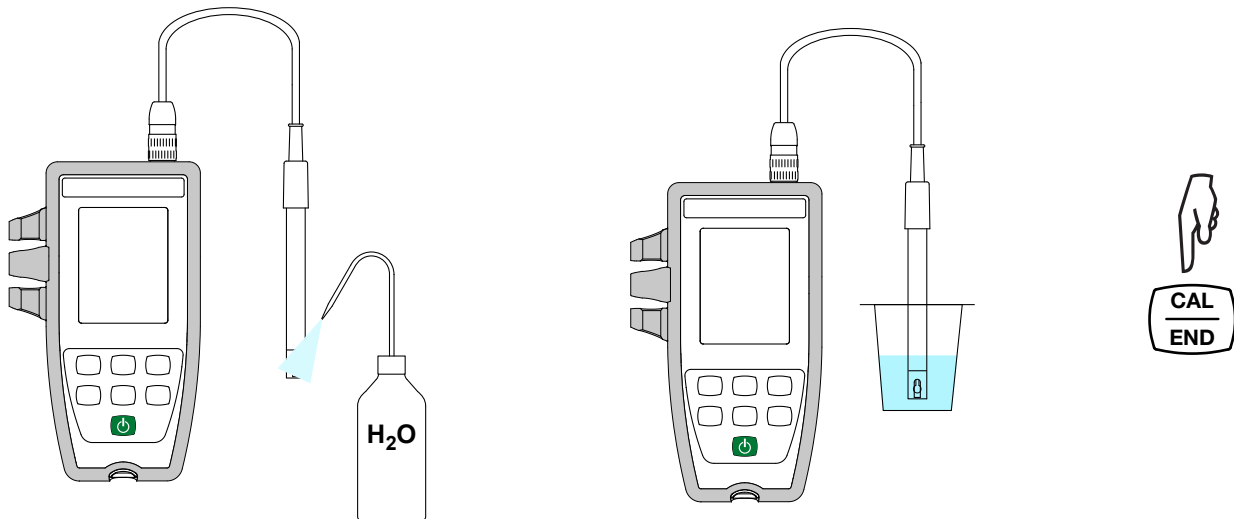

- Wait for the measurement to stabilize. Once again, the instrument proposes terminating the calibration (by pressing the **END** key) or continuing at a third point (by pressing the **CAL** key).

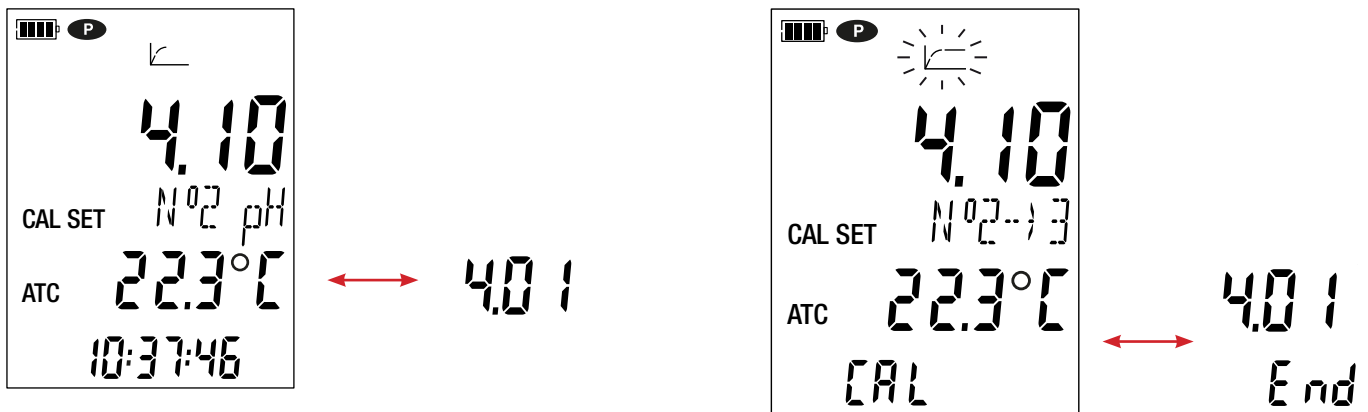

- If two calibration points are enough, long-press the **END** key. The slope and offset of the electrode will be calculated and displayed. However, you can continue the calibration on a third and last point by pressing the **CAL** key again.

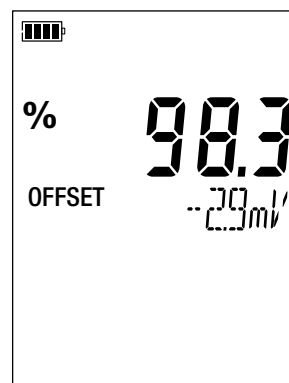
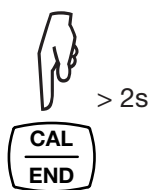

During the calibrations, the slope and offset of a given electrode must not vary more than a little. If you observe a large variation, redo the calibration. If the problem persists, check the buffer solution (in particular the use-by dates) or replace the electrode.

3.1.3. RESTORE THE INITIAL CALIBRATION

Press the **CAL** key, then the **MEM** key.

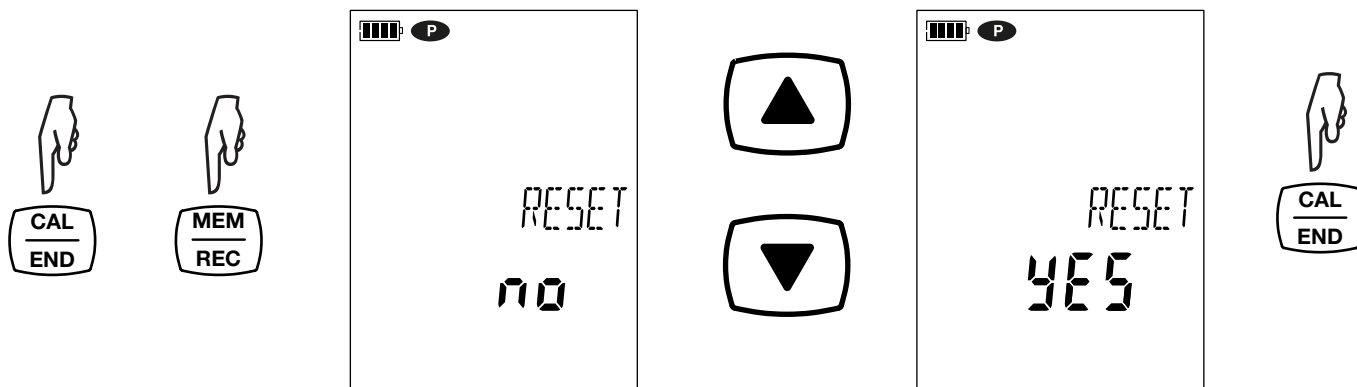



If you do not want to restore the initial calibration, choose **no** before pressing the **CAL** key.

Otherwise, choose **YES** and press the **CAL** key. The calibration values return to 100% for the slope and 0.0 mV for the offset.





3.1.4. MEASUREMENTS

Once the calibration is over, the electrode is ready to make measurements.

 Between measurements, the electrode must be rinsed and dried. When you have finished using it, put it back in its storage bottle.

 For each measurement, wait until the measurement has stabilized and the temperature is correctly established.

The  symbol indicates the quality of the electrode just calibrated. This lets you track the evolution of the state of your electrode and replace it when necessary.

Slope	Offset	State of the electrode
$95\% \leq \text{slope} \leq 105\%$	offset ≤ 19 mV	
$90\% \leq \text{slope} < 95\%$	$19 \text{ mV} < \text{offset} \leq 38 \text{ mV}$	
$85\% \leq \text{slope} < 90\%$	$38 \text{ mV} < \text{offset} \leq 58 \text{ mV}$	
$105\% < \text{slope} < 85\%$	$58 \text{ mV} < \text{offset}$	

It is the less good of the 2 states (slope and offset) that should be applied.

3.1.5. USE OF ANOTHER PH ELECTRODE

The electrode supplied with the instrument has an integrated temperature probe. If you use another electrode, one without an integrated temperature probe, you must measure the temperature of the solution.

The instrument indicates that the temperature can be modified by displaying **MTC** next to the temperature.
MTC = Manual Temperature Compensation.

You must then correct the temperature displayed, using the ▲ and ▼ keys, so that it is equal to the measured temperature of the solution.

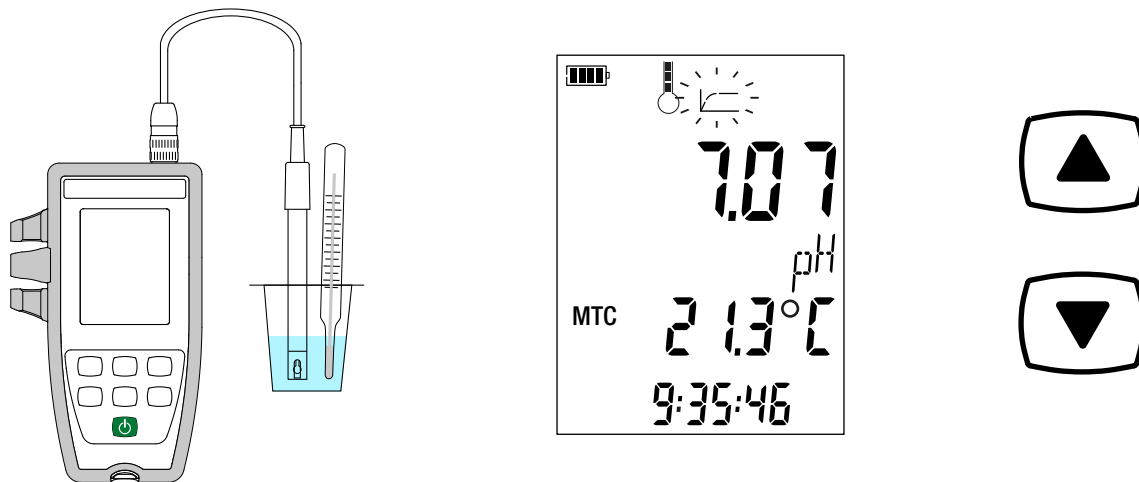

The instrument corrects the response of the electrode for temperature.



To calibrate the electrode, always correct the temperature first. And make sure that all of the buffer solutions are at the same temperature.

To connect your electrode, use one of the optional connection adapters (see § 1.2). These adapters also let you connect a PT1000 probe.

3.2. OXIDATION REDUCTION POTENTIAL MEASUREMENT (ORP)

ORP = Oxidation Reduction Potential

3.2.1. FIRST USE

During the first use, connect the ORP electrode (optional) to the measuring instrument. Connect the connector of the electrode to the instrument and screw the ring tight.

3.2.2. CALIBRATION

Calibration is done at a single point.

- Remove the storage bottle from the electrode.

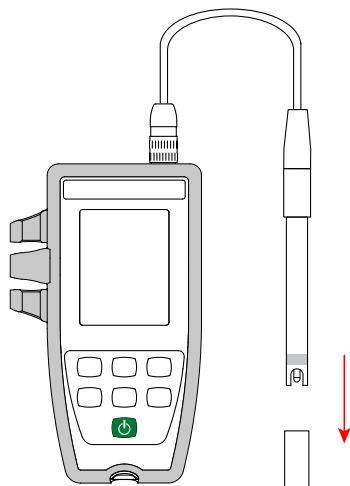

- Rinse the electrode in de-ionized water, then dry it.

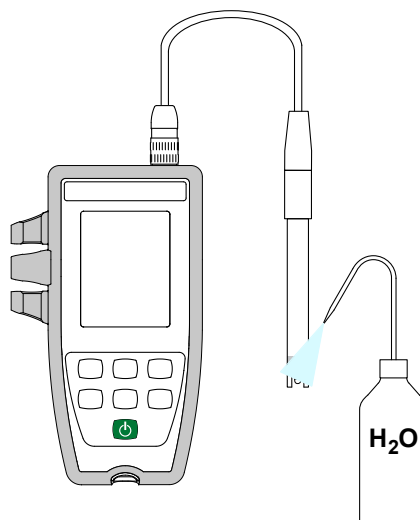

- Pour the buffer solution into a beaker.

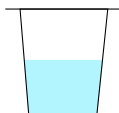

- Long-press the  key to switch the instrument on.
- Press the pH/mV key to switch to oxidation reduction potential measurement.

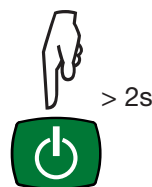

- If you spot an air bubble on the diaphragm, shake the electrode to eliminate it.
- Plunge the end of the electrode into the calibration solution.

 Take care to completely submerge the salt bridge in the solution.

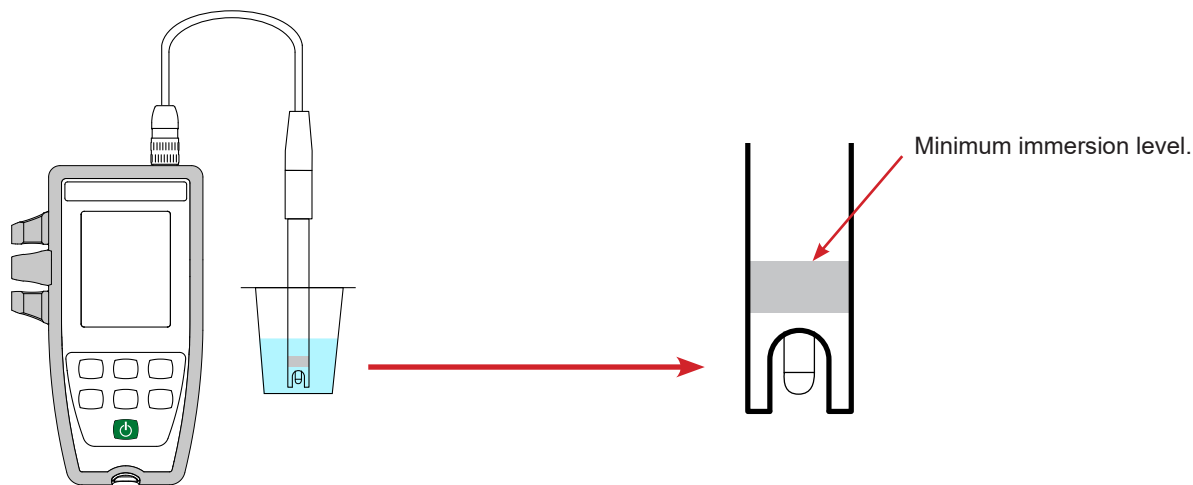

The electrode (optional) has an integrated temperature probe. There is therefore no need to measure the temperature of the solution.

- The instrument displays the ORP and temperature measurements and the time.
ATC = Automatic Temperature Compensation.
- Press the **CAL** key.
THE instrument briefly displays the current calibration value (the offset in mV).

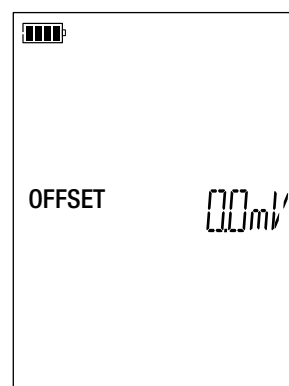
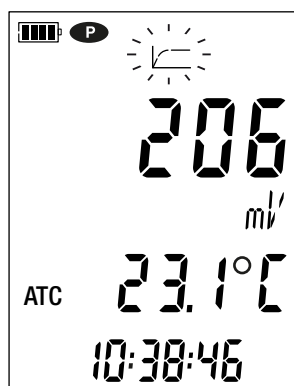

It then proposes selecting the calibration set. Two sets are available.

	ORP at 25°C (mV)
Calibration set 1	220
Calibration set 2	468

If you have your own calibration solutions, you can change these values in the ORP_Set.csv file (see §4.3).

- Choose the calibration set by long presses on the ▲ and ▼ keys.

- Validate the set by pressing the **CAL** key. When the instrument detects the value of the buffer solution, it displays it in alternation with the temperature.

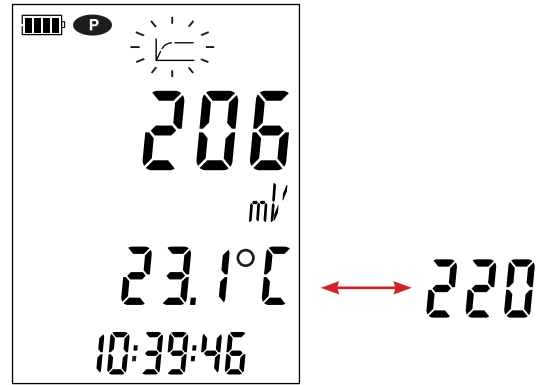
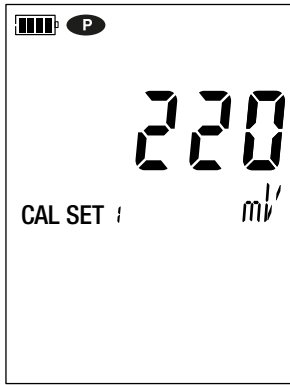

The instrument makes the ORP measurement and indicates its progress.

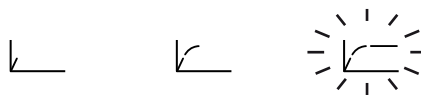

Do not withdraw the electrode from the solution until the measurement is over.

If you want to abort the calibration of the electrode, long-press the **END** key before the end of the measurement.

Otherwise, when the measurement has stabilized , the calibration is applied. Press the CAL key. The instrument briefly displays the offset before returning to measurement mode.

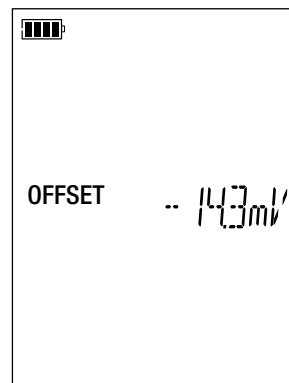

During the calibrations, the offset of a given electrode must not vary more than a little. If you observe a large variation, redo the calibration. If the problem persists, check the buffer solution (in particular the use-by dates) or replace the electrode.

3.2.3. RESTORE THE INITIAL CALIBRATION

Press the **CAL** key, then the **MEM** key.

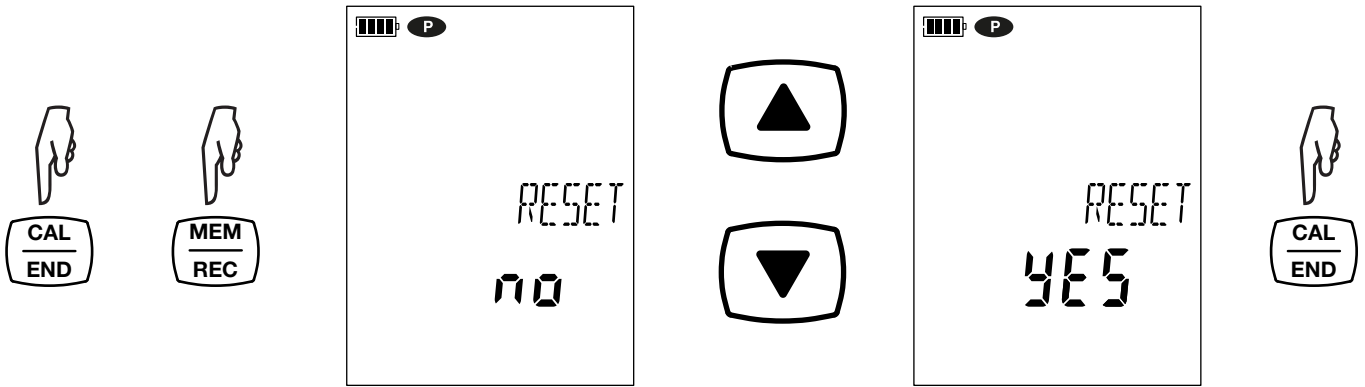

If you do not want to restore the initial calibration, choose **no** before pressing the **CAL** key.

Otherwise, choose **YES** and press the **CAL** key. The offset returns to 0.0 mV.

3.2.4. MEASUREMENTS

Once the calibration is over, the electrode is ready to make measurements.



Between measurements, the electrode must be rinsed and dried. When you have finished using it, put it back in its storage bottle.



For each measurement, wait for the measurement to stabilize.

3.3. RECORDING THE MEASUREMENTS

- A short press on the **MEM** key records the measurement with the date and time. The MEM symbol is displayed briefly. It is not possible to record a single measurement while the instrument is already recording.
- A long press on the **REC** key starts or stops a recording session. The REC symbol remains displayed for the duration of a recording session. Auto off is deactivated (this means that the instrument is in permanent mode) and the **P** symbol is displayed.

If the **REC** symbol flashes, a recording session has been programmed and is pending.



Before starting a recording session, make sure that the battery life is sufficient, or else connect the instrument to an external power supply on/to a wall outlet using a micro USB cord.

When the memory is 90% full, the **MEM FULL** symbol blinks. When the memory is full, the **MEM FULL** symbol stops blinking.

To see the records, you must use a PC and install the Data Logger Transfer software (see §4).

3.4. ERRORS

The instrument detects errors and displays them in the form Er.XX. The main errors are the following:

- Er.01: Hardware malfunction detected. The instrument must be sent in for repair.
- Er.02: Error in internal memory. Format it using Windows.
- Er.03: The update of the internal software is not compatible with the instrument (the software is that of another instrument of the line). Install the correct internal software in your instrument.
- Er.10: The instrument has not been calibrated or the calibration is not in conformity. The instrument must be sent back to customer service.
- Er.12: The update of the internal software is not compatible with the electronic boards in the instrument. Reload the previous internal software into your instrument.
- Er.13: Recording scheduling error. Check that the instrument's time and the time of the Data Logger Transfer software are the same.
- Er.14: Calibration error. The measured value is too far from the value of the standard solution of the selected calibration set. Check that the solution used in fact belongs to the selected set. If necessary, return to the initial calibration (see §3.1.3).
- Er.15: Calibration error. The stabilization time is too long.
- Er.16: pH calibration error. Two buffer solutions having the same value were used for the calibration.
- Er.17: Calibration error. The calculated offset is too large. Redo the calibration. If the error persists, check the buffer solution or replace the electrode.
- Er.18: pH calibration error. The calculated slope is too large (> 105%) or too small (< 85%). Redo the calibration. If the error persists, check the buffer solution or replace the electrode.
- Er.19: Calibration error. The temperature (ATC or MTC) is outside of the specifications of the buffer solutions. Redo the calibration in a room where the temperature lies within the specifications of the buffer solution (see the pH_Set.csv file §4.3).
- Er.20: Calibration error. The file defining the set of calibration solutions is missing. Download it from our web site: www.chauvin-arnoux.com
- Er.21: Calibration error. The file defining the set of calibration solutions is not in conformity. Check that it is the right file. If you have modified it, check the format; in particular, the decimal separators must be points, not commas.
- Er.22: Recording error. Power was cut off while recording was in progress.
- Er.50: Calibration error. Measurement error for the calibration.

To exit from calibration errors, press the **CAL** key or the **END** key.

4. USE IN RECORDING MODE

The instrument can operate in two modes:

- the stand-alone mode described in the previous section,
- the record mode, in which it is controlled by a PC. This mode is described below.

4.1. CONNECTION

The instrument communicates by a USB link, using the USB to micro USB cord provided.

4.2. GET DATA LOGGER TRANSFER SOFTWARE

Visit our web site to download the latest version of the application software:

www.chauvin-arnoux.com

Go to the **Support** tab, then **Download our software**. Then search on the name of your instrument.

Download the software, then install it on your PC.



You must have administrator privileges on your PC to install the Data Logger Transfer software.

Minimum computer requirements:

Windows 7 (32/64 bits)

2 GB of RAM

200 MB of disc space

Windows® is a registered trade mark of Microsoft®.



Do not connect the instrument to the PC until you have installed the Data Logger Transfer software.

4.3. USB LINK

Long-press the  key to switch the instrument on.

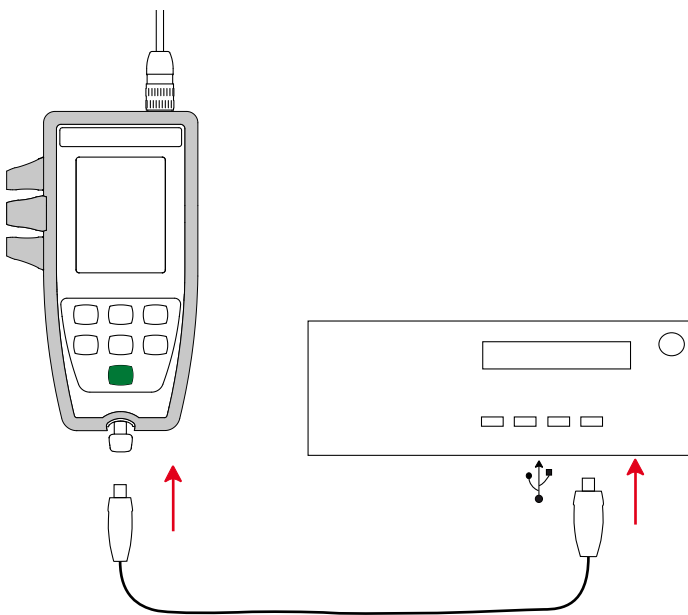

Once the Data Logger Transfer software has been installed, connect the instrument to the PC.

The  symbol blinks.

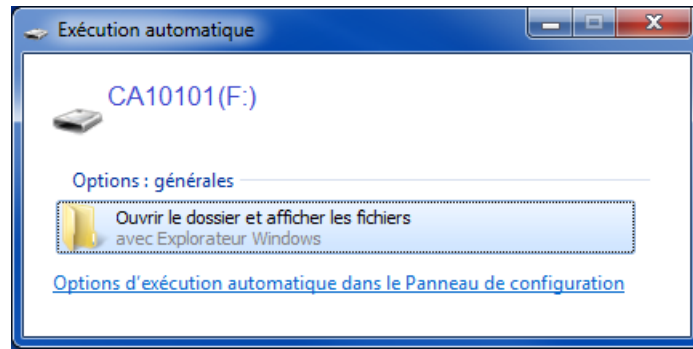

The instrument is treated as a USB key.

If you click **Open the folder and display the files**, you can access its contents. But to read the records, you must use the Data Logger Transfer software.

In the contents, you will find the pH_Set.csv and ORP_Set.csv files. You can open and modify these files using a spreadsheet:

- add or remove a calibration set
- modify a calibration set by adding, removing, or modifying buffer solutions.



Do not change the structure of the file.

For the ORP_Set.csv file

	A	B	C
1	SET NUMBER	2	
2	SOLUTION SET	1	
3	SOLUTION NUMBER	1	
4		220	
5	SOLUTION SET	2	
6	SOLUTION NUMBER	1	
7		468	
8			
9			
10			
11			

Number of calibration sets.

Calibration set number.

Number of buffer solutions in the calibration set (only one per set).

ORP of the buffer solutions in mV.

For the pH_Set.csv file

	A	B	C	D
1	SET NUMBER		3	
2	SOLUTION SET		1	
3	SOLUTION NUMBER		3	
4	BUFFER	pH	4.01	
5		TEMPERATURE [°C]	pH	
6			0 4.01	
7			5 4.01	
8			10 4.00	
9			15 4.00	
10			20 4.00	
11			25 4.01	
12			30 4.01	
13			35 4.02	
14			40 4.03	
15			45 4.04	
16			50 4.06	
17	BUFFER	pH	7.00	
18		TEMPERATURE [°C]	pH	
19			0 7.12	
20			5 7.09	
21			10 7.06	
22			15 7.04	
23			20 7.02	
24			25 7.00	
25			30 6.99	
26			35 6.98	
27			40 6.97	
28			45 6.97	
29			50 6.97	
30	BUFFER	pH	9.18	
31		TEMPERATURE [°C]	pH	
32			0 9.46	
33			5 9.39	
34			10 9.33	
35			15 9.28	
36			20 9.23	
37			25 9.18	
38			30 9.14	
39			35 9.11	
40			40 9.07	
41			45 9.04	
42			50 9.02	
43	SOLUTION SET		2	
44	SOLUTION NUMBER		4	
45	BUFFER	pH	1.68	
46		TEMPERATURE [°C]	pH	
47			0 1.67	

Number of calibration sets.

Calibration set number (1, 2, 3 ..).

Number of buffer solutions in the calibration set.

pH of the buffer solution.

pH of the buffer solution vs temperature.

4.4. DATA LOGGER TRANSFER SOFTWARE

Once the instrument is connected to the PC, open the Data Logger Transfer software.



For context-sensitive information about the use of the Data Logger Transfer software, refer to the **Help** menu.

4.4.1. CONNECTING THE INSTRUMENT

- To connect an instrument, click **Add an instrument**, then choose the type of connection (USB).

A window opens with a list of all instruments connected to the PC.

The name of the instrument will be formed from the model of the instrument and the warranty number: CA10141 - 123456ABC.

You can personalize your instrument by adding a name and a location, by clicking on or .

- Choose your instrument in the list. The instrument then displays complete information about the instrument and its measurements in progress.

The screenshot shows the 'Data Logger Transfer' software interface. The top menu bar includes File, Edit, View, Instrument, Tools, and Help. Below the menu is a toolbar with icons for Open, Save, Create report, Create DOCX, Print, Print Preview, Add an Instrument, Remove an Instrument, Download Recorded Data, Configure, and Start Recording. The left sidebar shows a 'Workstation' tree with 'Data Logger Network', 'pH meter', 'Recorded Sessions', 'Real-time Data', and 'My Open Sessions'. The main area displays the 'Status' window for the 'pH meter' instrument.

General		Recording	
Serial number	123456ABC	Recording status	Inactive
Model	10101	Session(s)	0
Firmware version	00.64	Idle	Elapsed
Instrument name	pH meter	Starting date/time	- - -
		Ending date/time	- - -
		Duration	15:00 (min:s)
		Recording Storage Rate	10 s
Status		Channel Configuration	
In overload	Yes	Channel 1	Temperature
Date	16/11/2018	Units:	°C
Time	09:17:43	Channel 2	pH
Battery voltage	5,36 V	Units:	pH
Communication		Sensor calibration	
Connection Type	USB	Last calibration date	02/01/2018
Connection status	Communicating	pH slope	100,0%
		pH offset	0 pH
		Number of solution(s)	1
		Solution 1, pH	7,00 pH
		Solution 1, temperature	25,0 °C
Memory			
Memory capacity	7,96 MBytes		
Memory used	522,00 kBytes		

4.4.2. DATE AND HOUR

In the **Instrument** menu, the icon lets you set your instrument's date and time.

These cannot be changed while recording or when a recording session has been scheduled.

By clicking , you can choose the date and time display formats.

4.4.3. AUTO OFF

As default, the instrument switches itself off automatically after 5 minutes of operation without the user's presence being confirmed by a key-press. By clicking , you can change this value to 3, 10, or 15 minutes.

It is also possible to disable this auto-off function; the instrument then displays the symbol.

4.4.4. PROGRAMMED RECORDING SESSIONS

By clicking , you can program a recording session. Assign a name to the recording session. Then enter a starting date and time and an ending date and time or a duration. The maximum duration of a recording session depends on the memory available.

Choose a sampling period. The possible values are: 1 s, 2 s, 5 s, 10 s, 20 s, 30 s, 1 min, 2 min, 5 min, 10 min, 15 min, 30 min and 1 hour. The shorter the sampling period, the larger the recorded file.

Before and after the recording session, if the instrument is switched on, the sampling period will be that of the stand-alone mode (1s).

If the instrument is off when recording starts, it switches itself on by itself. Then it displays the measurement, which it refreshes at each sampling period.

The **REC** symbol blinks on the display unit of the instrument to report that a recording session is pending. It stops blinking when the recording starts.



Before starting a recording session, make sure that the battery life is sufficient, or else connect the instrument to an external power supply to a wall outlet using a USB cord.

4.4.5. DISPLAY

By clicking , then going to the **pH-meter** tab, you can modify the display of the measurements on the instrument in the same ways as by pressing the **pH/mV** or **°C/°F** key.

4.4.6. READING THE RECORDS

The Data Logger Transfer software lets you read the records made. Click **Recorded Sessions** under the name of your instrument to obtain a list of the records.

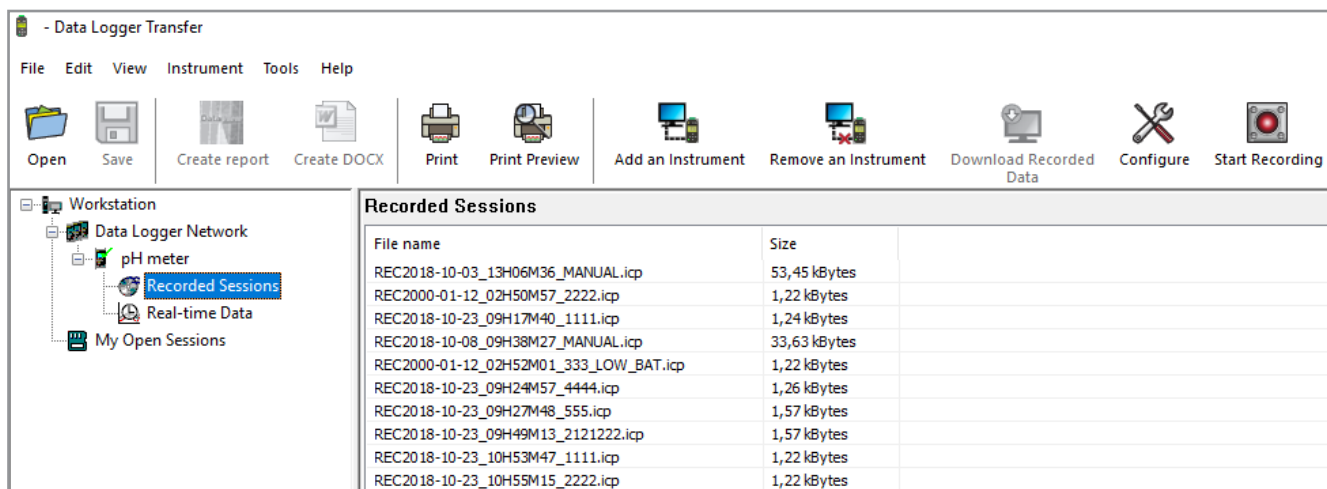

The screenshot shows the 'Data Logger Transfer' software interface. The menu bar includes File, Edit, View, Instrument, Tools, and Help. The toolbar contains icons for Open, Save, Create report, Create DOCX, Print, Print Preview, Add an Instrument, Remove an Instrument, Download Recorded Data, Configure, and Start Recording. The left sidebar shows a 'Workstation' tree with 'Data Logger Network' expanded to show 'pH meter', which has sub-items for 'Recorded Sessions' (highlighted), 'Real-time Data', and 'My Open Sessions'. The main window displays a table of recorded sessions.

File name	Size
REC2018-10-03_13H06M36_MANUAL.icp	53,45 kBytes
REC2000-01-12_02H50M57_2222.icp	1,22 kBytes
REC2018-10-23_09H17M40_1111.icp	1,24 kBytes
REC2018-10-08_09H38M27_MANUAL.icp	33,63 kBytes
REC2000-01-12_02H52M01_333_LOW_BAT.icp	1,22 kBytes
REC2018-10-23_09H24M57_4444.icp	1,26 kBytes
REC2018-10-23_09H27M48_555.icp	1,57 kBytes
REC2018-10-23_09H49M13_2121222.icp	1,57 kBytes
REC2018-10-23_10H53M47_1111.icp	1,22 kBytes
REC2018-10-23_10H55M15_2222.icp	1,22 kBytes

4.4.7. EXPORTING RECORDS

Once the list of the records is displayed, choose the one you want to export and convert it into a word-processing document (docx) or a spreadsheet (xlsx), in order to be able to use it in the form of reports or curves.

It is also possible to export the data to the DataView application software (see §1.2).

4.4.8. REAL-TIME MODE

Click **Real-time data** under the name of your instrument to see the measurements being made on the instrument as they are made.

4.4.9. FORMATTING THE MEMORY OF THE INSTRUMENT

The internal memory of the instrument is already formatted. But if there is a problem (if it becomes impossible to read or to write), it may be necessary to reformat it (in Windows).



In this case, all of the data will be lost.

5. TECHNICAL CHARACTERISTICS

5.1. REFERENCE CONDITIONS

Quantity of influence	Reference values
Temperature	23 ± 3°C
Relative humidity	45% to 75%
Battery supply voltage	4 to 6.4V
USB supply voltage	5V ± 5%
Electric field	< 1V/m
Magnetic field	< 40A/m

The intrinsic uncertainty is the error specified for the reference conditions.

It is expressed in % of the reading (L) and in mV.

± (a % L + b)

5.2. CHARACTERISTICS

The intrinsic uncertainties on the measurements are given for the instrument alone. The uncertainty of the electrode used must be added to them.

5.2.1. PH MEASUREMENTS

Instrument alone

Specified measurement range	-2.00 to 16.00
Resolution (R)	0.01
Intrinsic uncertainty of the instrument alone, without the electrode (E)	± 0.01 ± R

Instrument + XRGST1 pH electrode

Specified measurement range: 1.00 to 12.00 pH

5.2.2. ORP MEASUREMENTS

Specified measurement range	-199.9 to +199.9 mV	-1,999 to -200 and +200 to +1,999 mV
Resolution (R)	0.1 mV	1 mV
Intrinsic uncertainty of the instrument alone, without the electrode (E)	± 0.1 mV ± R	± 1 mV ± R

5.2.3. TEMPERATURE MEASUREMENTS

The temperature measurements are made using a PT1000 resistive probe integrated in the electrode

Specified measurement range	- 10.0 to + 120.0°C	14.0 to 248.0°F
Resolution (R)	Display in °C: 0.1°C	Display in °F: 0.1°F
Intrinsic uncertainty of the instrument alone, without the electrode (E)	< 0.4°C	< 0.7°F

5.2.4. INFLUENCE OF THE TEMPERATURE ON THE VALUES OF THE BUFFER SOLUTIONS

The pH values of the buffer solutions sold by Chauvin Arnoux vary as a function of the temperature as specified in the table below.

Temperature °C / °F	Buffer solution pH 1.68 NIST	Buffer solution pH 4.01 NIST	Buffer solution pH 7.00 NIST	Buffer solution pH 9.18 NIST	Buffer solution pH 10.01 NIST
0°C / 32°F	1.67	4.01	7.12	9.46	10.32
10°C / 50°F	1.67	4.00	7.06	9.33	10.18
15°C / 59°F	1.67	4.00	7.04	9.28	10.12
20°C / 68°F	1.68	4.00	7.02	9.23	10.06
25°C / 77°F	1.68	4.01	7.00	9.18	10.01
30°C / 86°F	1.68	4.01	6.99	9.14	9.97
40°C / 104°F	1.69	4.03	6.97	9.07	9.89
50°C / 122°F	1.71	4.06	6.97	9.02	9.83

Temperature °C / °F	Buffer solution pH 4,005 Cofrac-certified	Buffer solution pH 6,865 Cofrac-certified	Buffer solution pH 9,180 Cofrac-certified
0°C / 32°F	4.000	6.984	9.464
10°C / 50°F	3.997	6.923	9.332
15°C / 59°F	3.998	6.900	9.276
20°C / 68°F	4.001	6.881	9.225
25°C / 77°F	4.005	6.865	9.180
30°C / 86°F	4.011	6.853	9.139
40°C / 104°F	4.027	6.838	9.068
50°C / 122°F	4.050	6.833	9.010

5.2.5. INFLUENCE OF THE TEMPERATURE ON THE PH MEASUREMENT

The instrument corrects the response of the XRGST1 electrode as a function of temperature. During the calibration, the values of the buffer solutions are corrected for the temperature per the tables above.

5.2.6. INFLUENCE OF TEMPERATURE

Influence of temperature (from -10°C to 55°C at 50% RH) on the C.A 610101.

Type of measurement	Influence of temperature
pH measurement	< 0.02 pH
Oxidation reduction potential (ORP) measurement	< E ± R
Temperature measurement	from 10 to 55°C: < 0.2°C outside of this range: < 0.3°C

The values of E and R are given in §5.2.1.

5.2.7. INFLUENCE OF HUMIDITY

Influence of humidity (from 25 to 90% RH at 25°C) on the C.A 610101.

Type of measurement	Influence of humidity
pH measurement	< 0.02 pH
Oxidation reduction potential (ORP) measurement	< E ± R
Temperature measurement	< 0.2°C

The values of E and R are given in §5.2.1.

5.3. MEMORY

The size of the flash memory containing the records is 8 MB.

This capacity is sufficient to record more than 100,000 measurements. Each measurement is recorded with the date and time.



5.4. USB

Protocol: USB Mass Storage

Maximum transmission speed: 12 Mbit/s

Type B micro-USB connector B

5.5. POWER SUPPLY

The instrument is supplied by three 1.5V LR6 or AA alkaline batteries. It is possible to replace the batteries by rechargeable NiMH batteries of the same size. But the rechargeable batteries, even when correctly charged, will not reach the voltage of the alkaline batteries and the life indicated will be  or .

The voltage range ensuring correct operation is from 4.0 to 6.4 V for the alkaline batteries and 4.0 to 5.2 V for the rechargeable batteries.

Below 4V, the instrument stops making measurements and displays BA^t.

Battery life is 300 h.

The instrument can also be powered via a USB-micro USB cord, connected either to a PC or to a wall outlet via a mains adapter. The  symbol is displayed in this case.

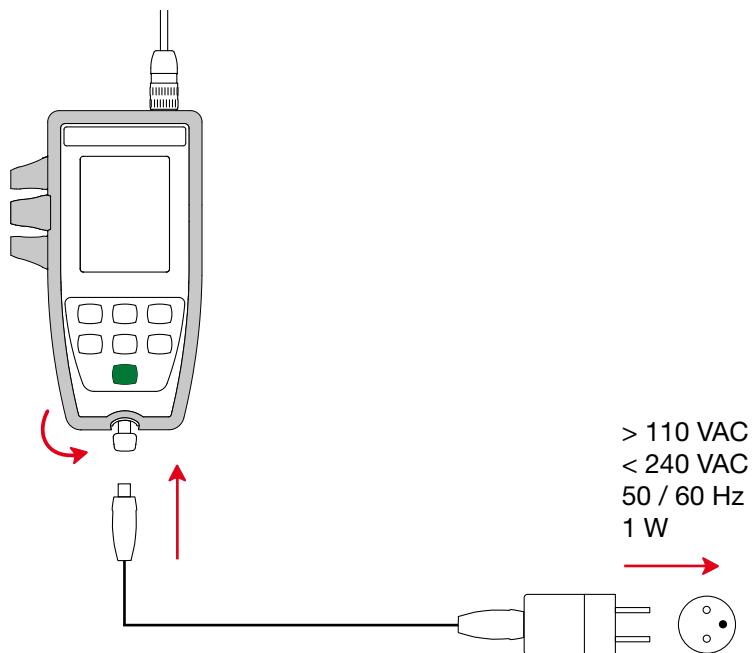

Connecting the external USB supply does not recharge the storage batteries.

5.6. ENVIRONMENTAL CONDITIONS

Instrument for indoor and outdoor use.

Altitude < 2000m, and 10,000m in storage.

Pollution degree 2

% RH

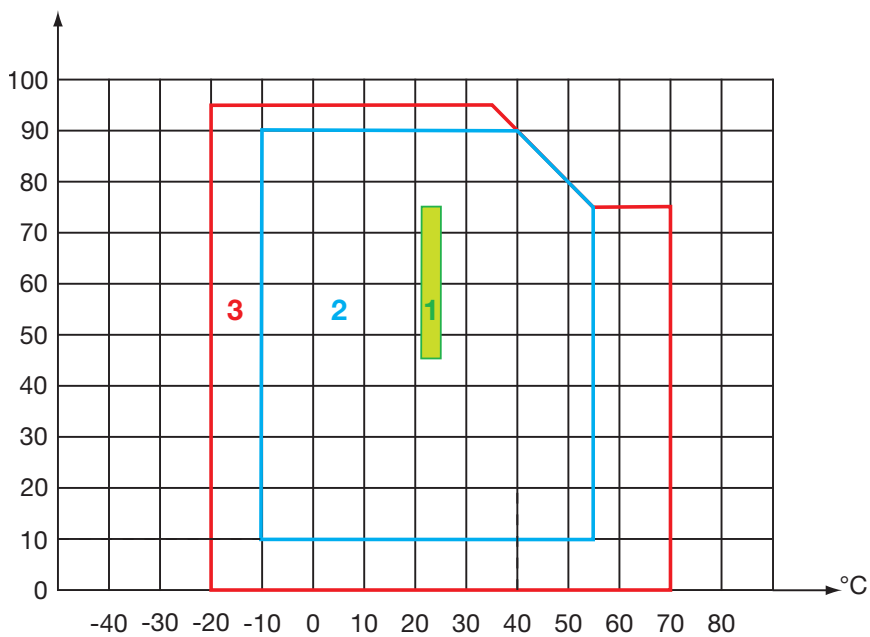

1 = Range of reference.

2 = Range of use.

3 = Storage range (with neither primary nor rechargeable batteries. Except electrodes and buffer solutions.)

5.7. MECHANICAL CHARACTERISTICS

Dimensions (L x W x D) 211 x 127 x 54mm with the sheath
Dimensions (L x W x D) 206 x 97 x 49mm without the sheath

Mass of the instrument approximately 600 g
Mass with the electrode approximately 720 g

Inrush protection IP 67 per IEC 60 529, with the USB connector closed and the electrode connected.
IP 20 otherwise.

Drop impact test 1.50m.

5.8. COMPLIANCE WITH INTERNATIONAL STANDARDS

The instrument is compliant with standard IEC 61010-2-30.

5.9. ELECTROMAGNETIC COMPATIBILITY (EMC)

The instrument is compliant with standard IEC 61326-1.
The influence of EMC is at most 0.25 pH.

6. MAINTENANCE



Except for the batteries, the instrument contains no parts that can be replaced by personnel who have not been specially trained and accredited. Any unauthorized repair or replacement of a part by an “equivalent” may gravely impair safety.

6.1. CLEANING

6.1.1. INSTRUMENT

Switch the instrument off.

Use a soft cloth, dampened with soapy water. Rinse with a damp cloth and dry rapidly with a dry cloth or forced air. Do not use alcohol, solvents, or hydrocarbons.

The two parts of the connector (instrument end and electrode end) must remain perfectly clean and dry. This is why it is best to leave the electrode connected to the instrument at all times.



At the event of immersion, dry the USB connector and the electrode connector of the instrument.

6.1.2. ELECTRODE

For the cleaning and maintenance of the electrodes, refer to their instruction sheets.

6.1.3. PROTECTIVE SHEATH

- To remove the protective sheath, first disconnect the electrode, then remove the wrist strap.
- Free the bottom of the casing from the sheath
- Then withdraw the housing from the sheath.

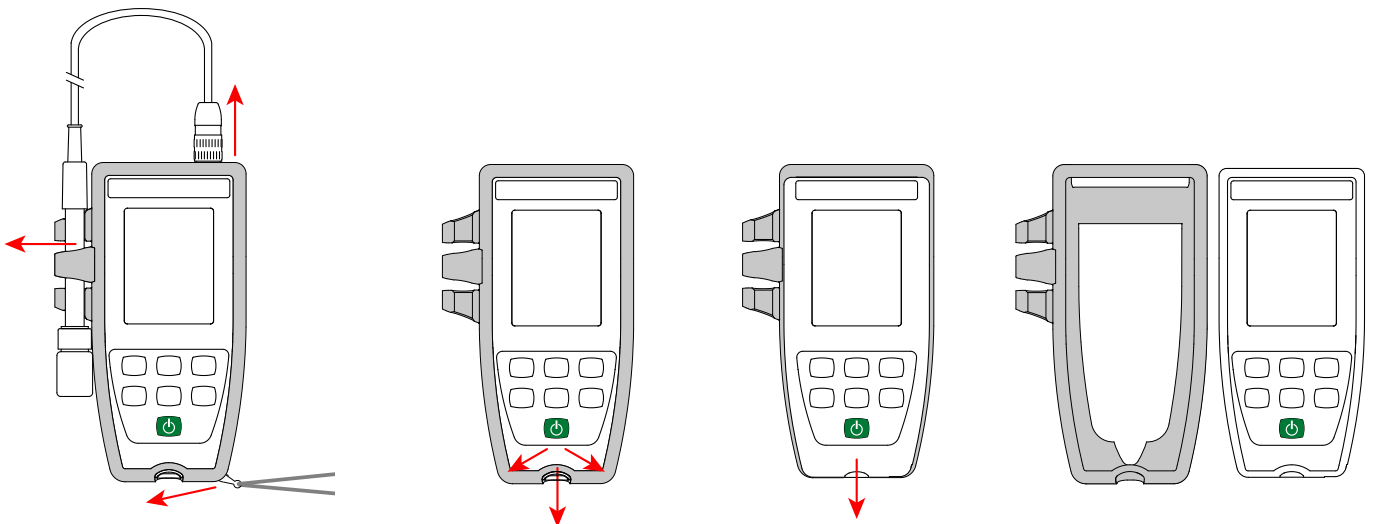

6.2. REPLACEMENT OF BATTERIES

The  symbol indicates the remaining battery life. When the  symbol is empty, all of the batteries must be replaced.

- Switch the instrument off.
- Refer to §1.4 for the replacement procedure.



Spent batteries must not be treated as ordinary household waste. Take them to the appropriate recycling collection point.



When the batteries are removed, the time is preserved for approximately two minutes.

6.3. SERIAL NUMBER

If you ever need to send your instrument in for repair, it will be helpful to know its serial number. It is found in the guarantee.txt file. This file is in your instrument's memory. To access it, simply connect the USB cord (see § 4.3).

The serial number is also marked on a label under the batteries.

6.4. CALIBRATION LOG

At each calibration, information is entered in the calib_log.txt file:

- the date and time, the slope and offset, the pH values on which the calibration was done.
- the date and time, the offset, the ORP value on which the calibration was done.

This file is in your instrument's memory. To access it, simply connect the USB cord (see § 4.3).

6.5. EMBEDDED SOFTWARE VERSION

To look up the version number of the embedded software in your instrument, press the **MEM** and  keys simultaneously. The instrument displays the number for a few seconds, then returns to measurement mode.

6.6. UPDATING THE EMBEDDED SOFTWARE

With a view to providing, at all times, the best possible service in terms of performance and technical improvements, Chauvin Arnoux offers you the possibility of updating the internal software of this instrument by downloading, free of charge, the new version available on our web site.

See you on our site:

www.chauvin-arnoux.com

Then go to "Support", then "Download our software", then "C.A 10101".



Updating the embedded software may reset the configuration and cause the loss of the recorded data. As a precaution, save the data in memory to a PC before updating the embedded software.

- Download the .bin file from our web site, then press and hold the **MEM** key and switch the instrument on by pressing the  key. The instrument displays BOOT.

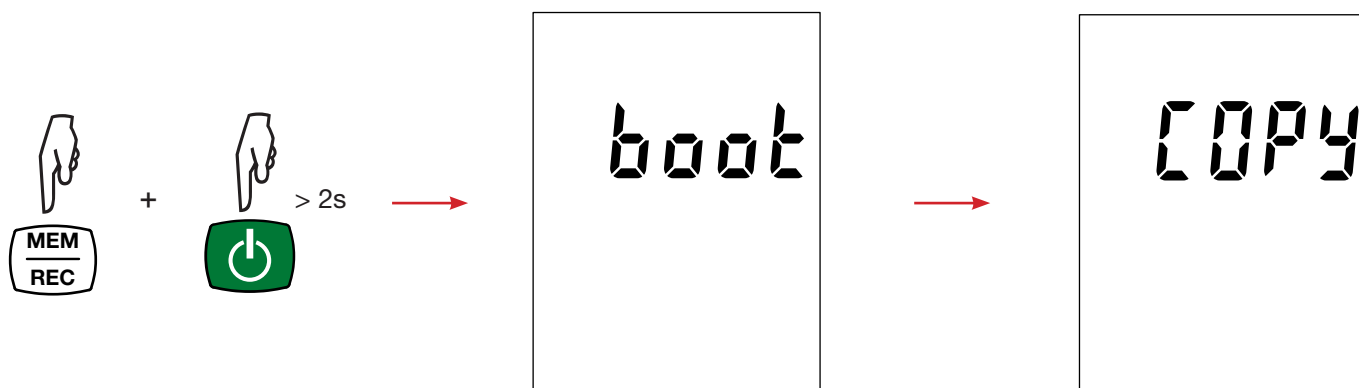

- Release the keys and the instrument displays **COPY**, indicating that it is ready to receive the new software.
- Connect the instrument to your PC using the USB cord provided.

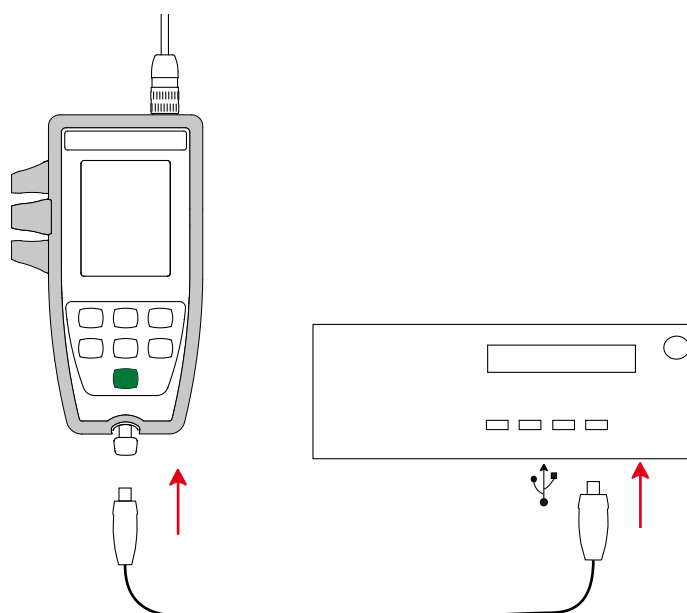

- Copy the .bin file to the instrument as if were a USB key.
- When the copying is done, press the **MEM** key and the instrument displays **LOAD**, indicating that the software is being installed.

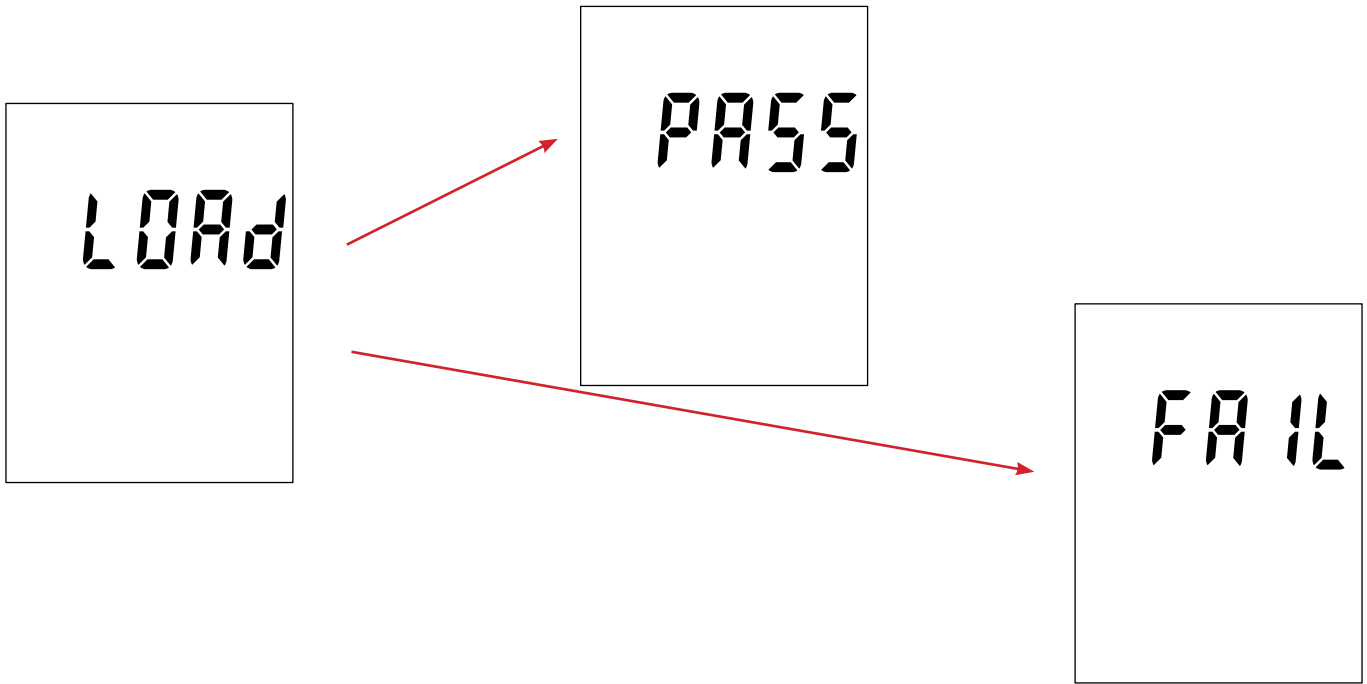

- When installation is done, the instrument displays **PASS** or **FAIL** according to whether or not the operation succeeded. If installation fails, download the software again and repeat the procedure.
- Then the instrument restarts normally.



After the internal software is updated, it may be necessary to reconfigure the instrument; see § 4.4.

7. WARRANTY

Except as otherwise stated, our warranty is valid for **24 months** starting from the date on which the equipment was sold. Extract from our General Conditions of Sale provided on request.

- The warranty does not apply in the following cases:
- Inappropriate use of the equipment or use with incompatible equipment;
- Modifications made to the equipment without the explicit permission of the manufacturer's technical staff;
- Work done on the device by a person not approved by the manufacturer;
- Adaptation to a particular application not anticipated in the definition of the equipment or not indicated in the user's manual;
- Damage caused by shocks, falls, or floods.

pH electrodes are wear parts. The life of your electrode depends on how you use and maintain it. The electrodes are warranted for **12 months**.

The warranty does not apply if the glass is broken.

FRANCE

Chauvin Arnoux Group

190, rue Championnet

75876 PARIS Cedex 18

Tél : +33 1 44 85 44 85

Fax : +33 1 46 27 73 89

info@chauvin-arnoux.com

www.chauvin-arnoux.com

INTERNATIONAL

Chauvin Arnoux Group

Tél : +33 1 44 85 44 38

Fax : +33 1 46 27 95 69

Our international contacts

www.chauvin-arnoux.com/contacts

