



Power Master XT
MI 2893
Instruction manual
Version 1.2.3 Code No. 20 752 835

Distributor:

Manufacturer:

METREL d.d.
Ljubljanska cesta 77
1354 Horjul
Slovenia

web site: <http://www.metrel.si>
e-mail: metrel@metrel.si



Mark on your equipment certifies that this equipment meets the requirements of the EU (European Union) concerning safety and interference causing equipment regulations

© 2020 METREL

No part of this publication may be reproduced or utilized in any form or by any means without permission in writing from METREL.

1	Introduction	14
1.1	Main Features	14
1.2	Safety considerations	15
1.3	Applicable standards	16
1.4	Abbreviations	17
2	Description	27
2.1	Front panel	27
2.2	Connector panel	28
2.3	Bottom view	29
2.4	Accessories	29
2.4.1	Standard accessories	29
2.4.2	Optional accessories	29
3	Operating the instrument	30
3.1	Instrument status bar	31
3.2	Instrument keys	32
3.3	Instrument memory (microSD card)	33
3.4	Instrument Main Menu	34
3.4.1	Instrument submenus	35
3.5	U, I, f	36
3.5.1	Meter	36
3.5.2	Scope	38
3.5.3	Trend	40
3.5.4	Voltage and current trends	40
3.6	Power	42
3.6.1	Meter	42
3.6.2	Trend	45
3.7	Energy	48
3.7.1	Meter	48
3.7.2	Trend	49
3.7.3	Efficiency	50
3.8	Harmonics / inter-harmonics	52
3.8.1	Meter	52
3.8.2	Histogram (Bar)	54
3.8.3	Harmonics Average Histogram (Avg Bar)	56
3.8.4	Trend	57
3.9	Flickers	59
3.9.1	Meter	59
3.9.2	Trend	60
3.10	Phase Diagram	62
3.10.1	Phase diagram	63
3.10.2	Unbalance diagram	64
3.10.3	Unbalance trend	65
3.11	Temperature	66
3.11.1	Meter	66
3.11.2	Trend	67
3.12	Under deviation and over deviation	67
3.12.1	Meter	68

3.12.2	Trend.....	69
3.13	Signalling.....	70
3.13.1	Meter	70
3.13.2	Trend.....	71
3.13.3	Table	72
3.14	General Recorder.....	73
3.15	Waveform/Inrush recorder	76
3.15.1	Setup	76
3.15.2	Capturing waveform	78
3.15.3	Captured waveform.....	80
3.16	Transient recorder	82
3.16.1	Setup	82
3.16.2	Capturing transients	85
3.16.3	Captured transients	86
3.17	Events table.....	87
3.17.1	Group view ▲	87
3.17.2	Phase view	89
3.18	Alarms table.....	91
3.19	Rapid voltage changes (RVC) table	93
3.20	Memory List	94
3.20.1	General Record	98
3.20.2	Waveform snapshot.....	101
3.20.3	Waveform/inrush record.....	102
3.20.4	Transients record	102
3.21	Measurement Setup submenu	103
3.21.1	Connection setup.....	103
3.21.2	Event setup	108
3.21.3	Alarm setup.....	110
3.21.4	Signalling setup	111
3.21.5	Rapid voltage changes (RVC) setup	112
3.21.6	Measuring Methods setup.....	113
3.21.7	Transient setup	114
3.22	General Setup submenu.....	114
3.22.1	Communication.....	115
3.22.2	Time & Date	117
3.22.3	Time & Date	117
3.22.4	Language	118
3.22.5	Instrument info	119
3.22.6	Lock/Unlock	119
3.22.7	Colour model	121
4	Recording Practice and Instrument Connection	122
4.1	Measurement campaign	122
4.2	Connection setup.....	128
4.2.1	Connection to the LV Power Systems	128
4.2.2	Connection to the MV or HV Power System	133
4.2.3	Current clamp selection and transformation ratio setting	137
4.2.4	Connection check.....	141
4.2.5	Temperature probe connection.....	143
4.2.6	GPS time synchronization device connection	144

4.2.1	Printing support	144
4.3	Remote instrument connection (over Internet/Internet(3G/GPRS)/Intranet (LAN))	146
4.3.1	Communication principle	146
4.3.2	Instrument setup on remote measurement site	147
4.3.3	PowerView setup for instrument remote access.....	148
4.3.4	Remote connection	149
4.4	Number of measured parameters and connection type relationship	160
5	Theory and internal operation	167
5.1	Measurement methods	167
5.1.1	Measurement aggregation over time intervals	167
5.1.2	Voltage measurement (magnitude of supply voltage)	167
5.1.3	Current measurement (magnitude of supply current)	168
5.1.4	Frequency measurement	169
5.1.5	Modern Power measurement.....	169
5.1.6	Classic Vector and Arithmetic Power measurement	174
5.1.7	Energy.....	177
5.1.8	Harmonics and interharmonics.....	178
5.1.9	Signalling	180
5.1.10	Flicker.....	180
5.1.11	Voltage and current unbalance	181
5.1.12	Under-deviation and over-deviation	182
5.1.13	Voltage events	182
5.1.14	Alarms	186
5.1.15	Rapid voltage changes (RVC)	186
5.1.16	Data aggregation in GENERAL RECORDING	187
5.1.17	Flagged data.....	191
5.1.18	Waveform snapshot.....	192
5.1.19	Waveform recorder	192
5.1.20	Transient recorder	196
5.2	EN 50160 Standard Overview	197
5.2.1	Power frequency	197
5.2.2	Supply voltage variations	197
5.2.3	Supply voltage unbalance	197
5.2.4	THD voltage and harmonics	198
5.2.5	Interharmonic voltage.....	198
5.2.6	Mains signalling on the supply voltage	198
5.2.7	Flicker severity	199
5.2.8	Voltage dips.....	199
5.2.9	Voltage swells.....	199
5.2.10	Short interruptions of the supply voltage.....	200
5.2.11	Long interruptions of the supply voltage.....	200
5.2.12	Power Master XT recorder setting for EN 50160 survey	200
6	Technical specifications	201
6.1	General specifications.....	201
6.2	Measurements	201
6.2.1	General description.....	201
6.2.2	Phase Voltages	202
6.2.3	Line voltages.....	203
6.2.4	Current	203
6.2.5	Frequency.....	207

6.2.6	Flickers.....	207
6.2.7	Transients.....	207
6.2.8	Fundamental power.....	208
6.2.9	Nonfundamental power.....	209
6.2.10	Power factor (PF, PFe, PFv, PFa).....	210
6.2.11	Displacement factor (DPF) or Cos ϕ	210
6.2.12	Energy.....	210
6.2.13	Voltage harmonics and THD.....	210
6.2.14	Current harmonics, THD and k-factor.....	211
6.2.15	Voltage interharmonics.....	211
6.2.16	Current interharmonics.....	212
6.2.17	Signalling.....	212
6.2.18	Unbalance.....	212
6.2.19	Overdeviation and Underdeviation.....	212
6.2.20	Time and duration uncertainty.....	213
6.2.21	Temperature probe.....	213
6.2.22	Phase angle.....	213
6.2.23	400Hz systems specification.....	213
6.2.24	VFD (Variable frequency drive) systems specification.....	213
6.2.25	Differences in specification between 400Hz, VFD and 50/60 Hz systems.....	213
6.3	Recorders.....	215
6.3.1	General recorder.....	215
6.3.2	Waveform/inrush recorder.....	216
6.3.3	Waveform snapshot.....	216
6.3.4	Transients recorder.....	216
6.4	Standards compliance.....	217
6.4.1	Compliance to the IEC 61557-12.....	217
6.4.2	Compliance to the to the IEC 61000-4-30.....	218
7	Maintenance.....	219
7.1	Inserting batteries into the instrument.....	219
7.2	Batteries.....	220
7.3	Firmware upgrade.....	221
7.3.1	Requirements.....	221
7.3.2	Upgrade procedure.....	221
7.4	Power supply considerations.....	225
7.5	Cleaning.....	225
7.6	Periodic calibration.....	226
7.7	Service.....	226
7.8	Troubleshooting.....	226
8	Version of document.....	226

List of tables:

Table 1: Power Master XT standard accessories	29
Table 2: Instrument status bar description.....	31
Table 3: Shortcut Keys and other Function keys.....	33
Table 4: Instrument Main menu	34
Table 5: Keys in Main menu	34
Table 6: Keys in submenus.....	36
Table 7: Instrument screen symbols and abbreviations.....	37
Table 8: Keys in Meter screens	38
Table 9: Instrument screen symbols and abbreviations.....	39
Table 10: Keys in Scope screens.....	39
Table 11: Instrument screen symbols and abbreviations.....	41
Table 12: Keys in Trend screens.....	41
Table 13: Instrument screen symbols and abbreviations (see 5.1.5 for details) – instantaneous values..	43
Table 14: Keys in Power (METER) screens	44
Table 15: Instrument screen symbols and abbreviations.....	45
Table 16: Keys in Power (TREND) screens	46
Table 17: Instrument screen symbols and abbreviations.....	48
Table 18: Keys in Energy (METER) screens	48
Table 19: Instrument screen symbols and abbreviations.....	49
Table 20: Keys in Energy (TREND) screens.....	49
Table 21: Instrument screen symbols and abbreviations.....	50
Table 22: Keys in Energy (TREND) screens.....	52
Table 23: Instrument screen symbols and abbreviations.....	53
Table 24: Keys in Harmonics / inter-harmonics (METER) screens.....	53
Table 25: Instrument screen symbols and abbreviations.....	54
Table 26: Keys in Harmonics / inter-harmonics (BAR) screens.....	55
Table 27: Instrument screen symbols and abbreviations.....	56
Table 28: Keys in Harmonics / inter-harmonics (AVG) screens	56
Table 29: Instrument screen symbols and abbreviations.....	58
Table 30: Keys in Harmonics / inter-harmonics (TREND) screens	58
Table 31: Instrument screen symbols and abbreviations.....	59
Table 32: Keys in Flickers (METER) screen	60
Table 33: Instrument screen symbols and abbreviations.....	60
Table 34: Keys in Flickers (TREND) screens.....	62
Table 35: Instrument screen symbols and abbreviations.....	63
Table 36: Keys in Phase diagram screen	63
Table 37: Instrument screen symbols and abbreviations.....	64
Table 38: Keys in Unbalance diagram screens.....	65
Table 39: Instrument screen symbols and abbreviations.....	65
Table 40: Keys in Unbalance trend screens	66
Table 41: Instrument screen symbols and abbreviations.....	66
Table 42: Keys in Temperature meter screen.....	66
Table 43: Instrument screen symbols and abbreviations.....	67
Table 44: Keys in Temperature trend screens	67
Table 45: Instrument screen symbols and abbreviations.....	68
Table 46: Keys in Under deviation and over deviation (METER) screen.....	68
Table 47: Instrument screen symbols and abbreviations.....	69
Table 48: Keys in Under deviation and Over deviation (TREND) screens.....	69
Table 49: Instrument screen symbols and abbreviations.....	70
Table 50: Keys in Signalling (METER) screen.....	70

Table 51: Instrument screen symbols and abbreviations	71
Table 52: Keys in Signalling (TREND) screen	71
Table 53: Instrument screen symbols and abbreviations	72
Table 54: Keys in Signalling (TABLE) screen	72
Table 55: General recorder settings description and screen symbols	73
Table 56: Keys in General recorder setup screen	75
Table 57: Waveform recorder settings description and screen symbols	76
Table 58: Keys in Waveform recorder setup screen	77
Table 59: Instrument screen symbols and abbreviations	79
Table 60: Keys in Waveform recorder capture screen	79
Table 61: Instrument screen symbols and abbreviations	80
Table 62: Keys in captured waveform recorder screens	80
Table 63: Transients on the low voltage network	82
Table 64: Transient recorder settings description and screen symbols	83
Table 65: Keys in Transient recorder setup screen	84
Table 66: Instrument screen symbols and abbreviations	85
Table 67: Keys in Transient recorder capture screen	85
Table 68: Instrument screen symbols and abbreviations	86
Table 69: Keys in captured transient recorder screens	86
Table 70: Instrument screen symbols and abbreviations	88
Table 71: Keys in Events table group view screens	88
Table 72: Instrument screen symbols and abbreviations	90
Table 73: Keys in Events table phase view screens	90
Table 74: Instrument screen symbols and abbreviations	92
Table 75: Keys in Alarms table screens	92
Table 76: Instrument screen symbols and abbreviations	93
Table 77: Keys in RVC Events table group view screens	94
Table 78: Instrument screen symbols and abbreviations	94
Table 79: Keys in Memory list (Folder) screen	95
Table 80: Instrument screen symbols and abbreviations	96
Table 81: Keys in Memory list screen	96
Table 82: Recorder settings description	98
Table 83: Keys in General record front page screen	98
Table 84: Instrument screen symbols and abbreviations	99
Table 85: Keys in Viewing recorder U,I,f TREND screens	100
Table 86: Recorder settings description	101
Table 87: Keys in Snapshot record front page screen	101
Table 88: Description of Measurement setup options	103
Table 89: Keys in Measurement setup submenu screen	103
Table 90: Description of Connection setup	104
Table 91: Keys in Connection setup menu	108
Table 92: Description of Event setup	109
Table 93: Keys in Event setup screen	109
Table 94: Description of Alarm setup	110
Table 95: Keys in Alarm setup screens	111
Table 96: Description of Signalling setup	111
Table 97: Keys in Signalling setup screen	112
Table 98: Description of RVC setup	112
Table 99: Keys in RVC setup screen	112
Table 100: Description of Measuring Methods setup	113
Table 101: Keys in Measuring Methods setup screen	113
Table 102: Description of Transient setup	114

Table 103: Description of General setup options	115
Table 104: Keys in General setup submenu.....	115
Table 105: Description of Communication setup options	116
Table 106: Keys in Communication setup.....	116
Table 107: Description of Set date/time screen	117
Table 108: Keys in Set date/time screen	118
Table 109: Keys in Language setup screen	118
Table 110: Keys in Instrument info screen.....	119
Table 111: Description of Lock/Unlock screen	119
Table 112: Keys in Lock/Unlock screen.....	120
Table 113: Locked instrument functionality	120
Table 114: Keys in Colour model screens	121
Table 115: Keys in Smart clamps pop up window	140
Table 116: Connection check description and screen symbols	142
Table 117: Keys in Connection check screen	143
Table 118: GPS functionality	144
Table 119: Keys in Set time zone screen.....	144
Table 120: DPU 414 Dip switches settings are shown on table below:	146
Table 121: Internet setup parameters.....	148
Table 122: Internet status bar icons	148
Table 123: Instrument selection form parameters.....	149
Table 124: Quantities measured by instrument	160
Table 125: Quantities recorded by instrument (Standard Profile)	162
Table 126: Quantities recorded by instrument (Limited Profile).....	165
Table 127: Summary and grouping of the phase power quantities	170
Table 128: Power summary and grouping of the total power quantities	170
Table 129: Summary and grouping of the phase power quantities	174
Table 130: Power summary and grouping of the total power quantities	175
Table 131: Alarm definition parameters.....	186
Table 132: Alarm signatures	186
Table 133: Data aggregation methods.....	188
Table 134: EN 50160 standard LV limits (continuous phenomena)	197
Table 135: Values of individual harmonic voltages at the supply	198
Table 136: Voltage dips classification.....	199
Table 137: Voltage swell classification	199
Table 138: General recording max. duration.....	215

List of Figures:

Figure 1: Power Master XT instrument.....	14
Figure 2: Front panel.....	27
Figure 3:Top connector panel	28
Figure 4: Side connector panel	28
Figure 5: Bottom view.....	29
Figure 6: Display symbols and keys description.....	30
Figure 7: Common display symbols and labels during measurement campaign	31
Figure 8: Instrument status bar	31
Figure 9: Inserting microSD card.....	33
Figure 10: “MAIN MENU”	34
Figure 11: Measurements submenu.....	35
Figure 12: Recorders submenu	35
Figure 13: Measurement setup submenu.....	35
Figure 14: General setup submenu.....	36
Figure 15: U, I, f meter phase table screens (L1, L2, L3, N).....	36
Figure 16: U, I, f meter summary table screens.....	37
Figure 17: Voltage only waveform.....	38
Figure 18: Current only waveform.....	38
Figure 19: Voltage and current waveform (single mode).....	39
Figure 20: Voltage and current waveform (dual mode)	39
Figure 21: Voltage trend (all voltages).....	40
Figure 22: Voltage trend (single voltage).....	40
Figure 23: Voltage and current trend (single mode)	40
Figure 24: Voltage and current trend (dual mode).....	40
Figure 25: Trends of all currents	41
Figure 26: Frequency trend.....	41
Figure 27: Power measurements summary (combined)	42
Figure 28: Power measurements summary (nonfundamental)	42
Figure 29: Power measurements summary (fundamental).....	42
Figure 30: Detailed power measurements at phase L1	43
Figure 31: Detailed total power measurements.....	43
Figure 32: Power trend screen.....	45
Figure 33: Energy counters screen.....	48
Figure 34: Energy trend screen.....	49
Figure 35: Energy efficiency screen	50
Figure 36: Harmonics and inter-harmonics (METER) screens	52
Figure 37: Phase harmonics presentation (U,I,P)	53
Figure 38: Harmonics histogram screen	54
Figure 39: Harmonics average histogram screen	56
Figure 40: Harmonics and inter-harmonics trend screen.....	57
Figure 41: Flickers table screen.....	59
Figure 42: Flickers trend screen.....	60
Figure 43: Phase diagram screen	63
Figure 44: Unbalance diagram screen	64
Figure 45: Symmetry trend screen	65
Figure 46: Temperature meter screen.....	66
Figure 47: Temperature trend screen.....	67
Figure 48: Under deviation and over deviation table screen	68
Figure 49: Under-deviation and over-deviation TREND screen.....	69
Figure 50: Signalling meter screen.....	70

Figure 51: Signalling trend screen.....	71
Figure 52: Signalling table screen	72
Figure 53: General recorder setup screen	73
Figure 54: Triggering in waveform record	76
Figure 55: Waveform recorder setup screen.....	76
Figure 56: Waveform recorder capture screen	78
Figure 57: Waveform recorder screen.....	78
Figure 58: Waveform recorder scope screen	79
Figure 59: Captured waveform recorder screen.....	80
Figure 60: Transient recorder setup screen.....	83
Figure 61: Transient recorder capture screen (waiting phase/recording)	85
Figure 62: Captured transient recorder screen	86
Figure 63: Voltage events in group view screen	87
Figure 64: Voltage event in detail view screen	88
Figure 65: Voltage events screens	90
Figure 66: Alarms list screen	92
Figure 67: RVC Events table group view screen.....	93
Figure 68: Memory list screen (Folder structure)	94
Figure 69: Memory list screen (Recorder data)	96
Figure 70: Front page of General record in MEMORY LIST menu	98
Figure 71: Viewing recorder U,I,f TREND data.....	99
Figure 72: Front page of Snapshot in MEMORY LIST menu	101
Figure 73: U,I,f meter screen in recalled snapshot record	102
Figure 74: MEASUREMENT SETUP submenu	103
Figure 75: "CONNECTION SETUP" screen	104
Figure 76: Event setup screen.....	109
Figure 77: Alarm setup screens.....	110
Figure 78: Signalling setup screen	111
Figure 79: RVC setup screen	112
Figure 80: Measuring Methods setup screen	113
Figure 81: Transient setup screen.....	114
Figure 82: GENERAL SETUP submenu	115
Figure 83: Communication setup screen	116
Figure 84: Set date/time screen	117
Figure 85: Language setup screen	118
Figure 86: Instrument info screen	119
Figure 87: Lock/Unlock screen.....	119
Figure 88: Locked instrument screen.....	120
Figure 89: Colour representation of phase voltages	121
Figure 4.1.1: Recommended measurement practice	125
Figure 2: Connection setup menu.....	128
Figure 3: Choosing 3-phase 4-wire system on instrument	128
Figure 4: 3-phase 4-wire system	129
Figure 5: Choosing 3-phase 3-wire system on instrument	129
Figure 6: 3-phase 3-wire system	129
Figure 7: Choosing Open Delta (Aaron) 3-wire system on instrument.....	130
Figure 8: Open Delta (Aaron) 3-wire system	130
Figure 9: Choosing 1-phase 3-wire system on instrument	130
Figure 10: 1-phase 3-wire system.....	131
Figure 11: Choosing 2-phase 4-wire system on instrument	131
Figure 12: 2-phase 4-wire system.....	132
Figure 13: Choosing single- phase Inverter system on instrument	132

Figure 14: Single – phase inverter system	132
Figure 15: Choosing three- phase Inverter system on instrument	133
Figure 16: Three – phase inverter system	133
Figure 17: Voltage ratio for 11 kV / 110 kV transformer example	133
Figure 18: Connecting instrument to the existing current transformers in medium voltage system (Aaron / OpenDelta)	134
Figure 19: Connecting instrument to the existing current transformers in medium voltage system (Delta – Delta).....	135
Figure 20: Connecting instrument to the existing current transformers in medium voltage system (Delta – Star).....	135
Figure 21: Connecting instrument to the existing current transformers in medium voltage system (Star – Star).....	136
Figure 22: Connecting instrument to the existing current transformers in medium voltage system (star – delta)	136
Figure 23: Smart current clamps auto range selection.....	137
Figure 24: Parallel feeding of large load	138
Figure 25: Current clamps selection for indirect current measurement	139
Figure 26: Selecting 10% of current clamps range.....	139
Figure 27: Automatically recognised clamps setup	140
Figure 28: Automatically recognised clamps status.....	140
Figure 29: Set time zone screen.....	144
Figure 30: Connecting printer DPU 414 with instrument	145
Figure 31: SCOPE screen print	145
Figure 32: Schematic view on the remote measurements	147
Figure 33: Internet connection setup screen.....	148
Figure 34: PowerView v3.0 remote connection settings form	149
Figure 35: PowerView v3.0 remote connection monitor	150
Figure 36: PowerView connection to LAN and Metrel Server established (Steps 1 & 2)	151
Figure 37: Remote instrument connection to Metrel Server established (Step 3)	152
Figure 38: Remote instrument connection to PowerView v3.0 established (Step 4).....	153
Figure 39: Active connection indication	153
Figure 40: Remote connection icon	154
Figure 41: Detection of the instrument type	154
Figure 42: Selecting records from a list for download.....	155
Figure 43: Real time scope window in remote connection, with several channels selected	156
Figure 44: Remote Instrument Configuration form.....	157
Figure 45: Remote Recorder configuration	158
Figure 46: Recording in progress	159
Figure 136: Phase and Phase-to-phase (line) voltage.....	168
Figure 137: IEEE 1459 phase power measurement organisation (phase).....	169
Figure 138: IEEE 1459 phase power measurement organisation (totals).....	170
Figure 139: Vector representation of total power calculus.....	174
Figure 140: Arithmetic representation of total power calculus	174
Figure 141: Energy counters and quadrant relationship	177
Figure 142: Instrument energy counters	178
Figure 143: Current and voltage harmonics	178
Figure 144: Illustration of harmonics / interharmonics subgroup for 50 Hz supply.....	180
Figure 145: Voltage fluctuation	181
Figure 146: $U_{Rms(1/2)}$ 1-cycle measurement	183
Figure 147: Voltage events definition.....	183
Figure 148: Voltage dip related screens on the instrument.....	184
Figure 149: Voltage interrupts related screens on the instrument.....	185

Figure 61: RVC event description.....	187
Figure 151: Synchronization and aggregation of 10/12 cycle intervals.....	188
Figure 152: Avg vs. Avgon, switching load current	190
Figure 153: Consumed/generated and inductive/capacitive phase/polarity diagram.....	191
Figure 154: Flagging data indicate that aggregated value might be unreliable	192
Figure 155: Triggering and pre-triggering description.....	193
Figure 156: Voltage Event Triggering.....	193
Figure 157: Voltage Level Triggering.....	194
Figure 158: Current Level Triggering (Inrush)	194
Figure 159: Waveform recorder setup for triggering on voltage events.....	195
Figure 160: Level triggering	195
Figure 161: Triggering slope.....	196
Figure 162: Transients trigger detection (envelope)	196
Figure 163: Transients trigger detection (level).....	196
Figure 164: Mains signalling voltage level limits according to EN50160	199
Figure 165: Predefined EN50160 recorder configuration.....	200
Figure 166: Battery compartment	219
Figure 167: Closing the battery compartment cover	220
Figure 168: PowerView update function	221
Figure 169: Selecting USB communication	222
Figure 170: Check for Firmware menu	222
Figure 171: Check for Firmware menu	222
Figure 172: New firmware is available for download.....	223
Figure 173: FlashMe firmware upgrade software	223
Figure 174: FlashMe configuration screen	224
Figure 175: FlashMe programming screen	225

1 Introduction

Power Master XT MI 2893 is handheld multifunction instrument for power quality analysis, high speed transient capturing and troubleshooting as well as energy efficiency measurements.



Figure 1: Power Master XT instrument

1.1 Main Features

- Full compliance with power quality standard IEC 61000-4-30 Class A.
- Simple and powerful recorder with microSD memory card (sizes up to 32 GB are supported).
- 4 voltage channels with wide measurement range: up to 1000 Vrms, CAT III / 1000 V, with support for medium and high voltage systems.
- Simultaneous voltage and current (8 channels) sampling, 16-bit AD conversion for accurate power measurements and minimal phase shift error.
- 4 current channels with support for automatic clamp recognition and automatic range selection.
- Compliance with IEC 61557-12 and IEEE 1459 (Combined, fundamental, nonfundamental power) and IEC 62053-21 (Energy).
- High speed transient sampling > 1MSamples/sec simultaneously on all 8 channels (4xU & 4xI)
- Transient selection between N /GND
- 4.3" TFT colour display.
- Waveform/inrush recorder, which can be triggered on event/alarms/Level U/Level I/Interval; transient recorder for phase/neutral lines (voltage and current simultaneously) with level and envelope trigger selection run simultaneously with general recorder.
- Support for 50Hz, 60Hz, 400Hz system frequency and direct VFD (variable frequency drives) measurement

- PC Software **PowerView v3.0** is an integral part of a measuring system which provides easiest way to download, view and analyse measured data or print reports.
 - PowerView v3.0 analyser exposes a simple but powerful interface for downloading instrument data and getting quick, intuitive and descriptive analysis. Interface has been organized to allow quick selection of data using a Windows Explorer-like tree view.
 - User can easily download recorded data, and organize it into multiple sites with many sub-sites or locations.
 - Generate charts, tables and graphs for your power quality data analysing, and create professional printed reports.
 - Export or copy / paste data to other applications (e.g. spreadsheet) for further analysis.
 - Multiple data records can be displayed and analysed simultaneously.
 - Merge different logging data into one measurement, synchronize data recorded with different instruments with time offsets, split logging data into multiple measurements, or extract data of interest.
 - Instrument remote access over internet connection.

1.2 Safety considerations

To ensure operator safety while using the Power Master XT instruments and to minimize the risk of damage to the instrument, please note the following general warnings:



The instrument has been designed to ensure maximum operator safety. Usage in a way other than specified in this manual may increase the risk of harm to the operator!



Do not use the instrument and/or accessories if any visible damage is noticed!



The instrument contains no user serviceable parts. Only an authorized dealer can carry out service or adjustment!



All normal safety precautions have to be taken in order to avoid risk of electric shock when working on electrical installations!



Only use approved accessories which are available from your distributor!



Instrument contains rechargeable NiMH batteries. The batteries should only be replaced with the same type as defined on the battery placement label or in this manual. Do not use standard batteries while power supply adapter/charger is connected, otherwise they may explode!



Hazardous voltages exist inside the instrument. Disconnect all test leads, remove the power supply cable and switch off the instrument before removing battery compartment cover.



Maximum nominal voltage between any phase and neutral input is 1000 V_{RMS}. Maximum nominal voltage between phases is 1730 V_{RMS}.



Always short unused voltage inputs (L1, L2, L3, GND) with neutral (N) input to prevent measurement errors and false event triggering due to noise coupling.



Do not remove microSD memory card while instrument is recording or reading data. Record damage and card failure can occur.

1.3 Applicable standards

The Power Master XT are designed and tested in accordance with the following standards:

Electromagnetic compatibility (EMC)

EN 61326-2-2: 2013

Electrical equipment for measurement, control and laboratory use – EMC requirements – Part 2-2: Particular requirements - Test configurations, operational conditions and performance criteria for portable test, measuring and monitoring equipment used in low-voltage distribution systems

- Emission: Class A equipment (for industrial purposes)
- Immunity for equipment intended for use in industrial locations

Safety (LVD)

EN 61010-1: 2010

Safety requirements for electrical equipment for measurement, control and laboratory use – Part 1: General requirements

EN 61010-2-030: 2017

Safety requirements for electrical equipment for measurement, control and laboratory use – Part 2-030: Particular requirements for testing and measuring circuits

EN 61010-031: 2015

Safety requirements for electrical equipment for measurement, control and laboratory use – Part 031: Safety requirements for hand-held probe assemblies for electrical measurement and test

EN 61010-2-032: 2012

Safety requirements for electrical equipment for measurement, control and laboratory use Part 032: Particular requirements for hand-held and hand-manipulated current sensors for electrical test and measurement

Measurement methods

IEC 61000-4-30: 2015 Class A Ed3.

Part 4-30: Testing and measurement techniques – Power quality measurement methods

IEC 61557-12: 2018

Equipment for testing, measuring or monitoring of protective measures – Part 12: Performance measuring and monitoring devices (PMD)

IEC 61000-4-7: 2002 + A1: 2008

Part 4-7: Testing and measurement techniques –General guide on harmonics and inter-harmonics measurements and instrumentation for power supply systems and equipment connected thereto

IEC 61000-4-15: 2010/ISH1:2017

Part 4-15: Testing and measurement techniques –Flicker meter – Functional and design specifications

IEC 62053-21: 2003

Part 21: Static meters for active energy (Class 1)

IEC 62053-23: 2003

Part 23: Static meters for reactive energy (Class 2)

IEEE 1459: 2010

IEEE Standard Definitions for the Measurement of Electric Power Quantities Under Sinusoidal, Non-sinusoidal, Balanced, or Unbalanced Conditions

EN 50160: 2010

Voltage characteristics of electricity supplied by public electricity networks

GOST R 54149: 2010

Electric energy. Electromagnetic compatibility of technical equipment. Power quality limits in the public power supply systems

Note about EN and IEC standards:

Text of this manual contains references to European standards. All standards of EN 6XXXX (e.g. EN 61010) series are equivalent to IEC standards with the same number (e.g. IEC 61010) and differ only in amended parts required by European harmonization procedure.

1.4 Abbreviations

In this document following symbols and abbreviations are used:

CF_I	Current crest factor, including CF_{Ip} (phase p current crest factor) and CF_{IN} (neutral current crest factor). See 5.1.3 for definition.	
CF_U	Voltage crest factor, including CF_{Upq} (phase p to phase q voltage crest factor) and CF_{Up} (phase p to neutral voltage crest factor). See 5.1.2 for definition.	
$\pm DPF_{ind/cap}$	Instantaneous phase power displacement (fundamental) power factor or $\cos \varphi$, including $\pm DPF_{p_{ind}}$ (phase p power displacement). Minus sign indicates generated power and plus sign indicates consumed power. Suffix <i>ind/cap</i> represents inductive/capacitive character.	
$DPF_{ind/cap}^{\pm}$	Recorded phase displacement (fundamental) power factor or $\cos \varphi$, including $DPF_{p_{ind/cap}}^{\pm}$ (phase p power displacement). Minus sign indicates generated power and plus sign indicates consumed power. Suffix <i>ind/cap</i> represents inductive/ capacitive character. This parameter is recorded separately for each quadrant as shown on figure. See 5.1.5 for definition.	
$\pm DPFa_{totind}$ $\pm DPFa_{totcap}$	Instantaneous total arithmetic displacement (fundamental) power factor. Minus sign indicates generated power and plus sign indicates consumed power. Suffix <i>ind/cap</i> represents inductive/capacitive character. See 5.1.6 for definition.	
$DPFa_{totind}^{\pm}$ $DPFa_{totcap}^{\pm}$	Recorded total arithmetic fundamental power factor. Minus sign indicates generated power and plus sign indicates consumed power. Suffix <i>ind/cap</i> represents inductive/capacitive character. This parameter is recorded separately as shown on figure. See 5.1.6 for definition.	
$\pm DPFV_{totind}$	Instantaneous positive sequence total vector displacement (fundamental) power factor.	

$\pm DPFV_{totcap}$ Minus sign indicates generated power and plus sign indicates consumed power. Suffix *ind/cap* represents inductive/capacitive character. See 5.1.6 for definition.

Recorded total vector fundamental power factor.

Minus sign indicates generated power and plus sign indicates consumed power. Suffix *ind/cap* represents inductive/capacitive character. This parameter is recorded separately as shown on figure. See 5.1.6 for definition.

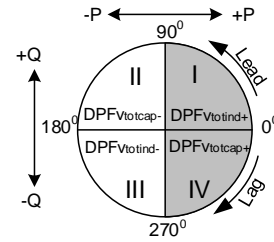

Instantaneous positive sequence fundamental power factor.

Minus sign indicates generated power and plus sign indicates consumed power. Suffix *ind/cap* represents inductive/capacitive character. See 5.1.5 for definition.

Recorded total positive sequence fundamental power factor.

Minus sign indicates generated power and plus sign indicates consumed power. Suffix *ind/cap* represents inductive/capacitive character. This parameter is recorded separately as shown on figure. See 5.1.5 for definition.

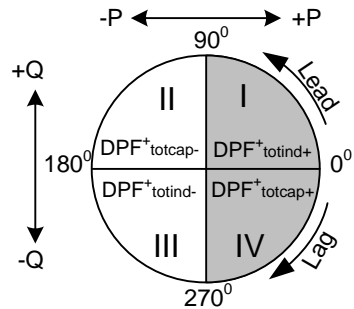

D_I Phase current distortion power, including D_{ip} (phase p current distortion power). See 5.1.5 section: Modern Power measurement
Standard compliance: IEEE 1459-2010 for definition.

De_I Total effective current distortion power. See 5.1.5 section: Modern Power measurement
Standard compliance: IEEE 1459-2010 for definition.

DH Phase harmonics distortion power, including D_{Hp} (phase p harmonics distortion power). See 5.1.5 section: Modern Power measurement
Standard compliance: IEEE 1459-2010 for definition.

DeH Total effective harmonics distortion power. See 5.1.5 section: Total nonfundamental power measurements for definition.

Dv Phase voltage distortion power, including D_{vp} (phase p voltage distortion power). See 5.1.5 section: Modern Power measurement
Standard compliance: IEEE 1459-2010 for definition.

Dev_{tot} Total effective voltage distortion power. See 5.1.5 section: Modern Power measurement
Standard compliance: IEEE 1459-2010 for definition.

E_p^\pm Recorded phase combined (fundamental and nonfundamental)

	active energy, including $Ep_p^{+/-}$ (phase p active energy). Minus sign indicates generated energy and plus sign indicates consumed energy. See 5.1.6 for definition.
Ep_{tot}^{\pm}	Recorded total combined (fundamental and nonfundamental) active energy. Minus sign indicates generated and plus sign indicates consumed energy. See 5.1.6 for definition.
Eq^{\pm}	Recorded phase fundamental reactive energy, including $Eq_p^{+/-}$ (phase p reactive energy). Minus sign indicates generated and plus sign indicates consumed energy. See 5.1.6 for definition.
Eq_{tot}^{\pm}	Recorded total fundamental reactive energy. Minus sign indicates generated and plus sign indicates consumed energy. See 5.1.6 for definition.
Eff_{inv}	Photovoltaic inverter efficiency
$f, freq$	Frequency, including $freq_{U12}$ (voltage frequency on U_{12}), $freq_{U1}$ (voltage frequency on U_1) and $freq_{I1}$ (current frequency on I_1). See 5.1.4 for definition.
\bar{i}	Negative sequence current ratio (%). See 5.1.11 for definition.
i^0	Zero sequence current ratio (%). See 5.1.11 for definition.
i^+	Positive sequence current component on three phase systems. See 5.1.11 for definition.
i^-	Negative sequence current component on three phase systems. See 5.1.11 for definition.
i^0	Zero sequence current components on three phase systems. See 5.1.11 for definition.
$I_{Rms(1/2)}$	RMS current measured over 1 cycle, commencing at a fundamental zero crossing on an associated voltage channel, and refreshed each half-cycle, including $I_{pRms(1/2)}$ (phase p current), $I_{NRms(1/2)}$ (neutral RMS current)
I_{fund}	Fundamental RMS current I_{h1} (on 1 st harmonics), including I_{fund_p} (phase p fundamental RMS current) and I_{fund_N} (neutral RMS fundamental current). See 5.1.8 for definition
I_{h_n}	n^{th} current RMS harmonic component including I_{ph_n} (phase p; n^{th} RMS current harmonic component) and I_{Nh_n} (neutral n^{th} RMS current harmonic component). See 5.1.8 for definition
I_{ih_n}	n^{th} current RMS inter-harmonic component including I_{pih_n} (phase p; n^{th} RMS current inter-harmonic component) and I_{Nih_n} (neutral n^{th} RMS current inter-harmonic component). See 5.1.8 for definition
I_{Nom}	Nominal current. Current of clamp-on current sensor for 1 V_{rms} at output.
I_{pk}	Peak current, including I_{ppk} (phase p current) including I_{Npk} (neutral peak current)
I_{Rms}	RMS current, including I_{pRms} (phase p current), I_{NRms} (neutral RMS current). See 5.1.3 for definition.
I_{rmsinv}	Photovoltaic inverter RMS current

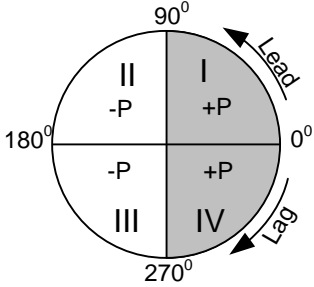
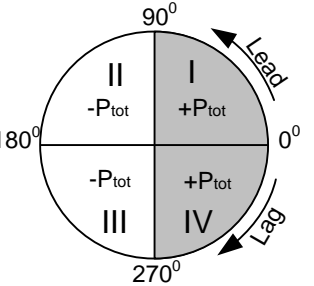
I_{acinv}	Photovoltaic inverter AC current
I_{dcinv}	Photovoltaic inverter DC current
$\pm P$	<p>Instantaneous phase active combined (fundamental and nonfundamental) power, including $\pm P_p$ (phase p active power). Minus sign indicates generated and plus sign indicates consumed power. See 5.1.5 for definitions.</p> 
P^\pm	Recorded phase active (fundamental and nonfundamental) power, including P_p^\pm (phase p active power). Minus sign indicates generated and plus sign indicates consumed power. See 5.1.5 for definitions.
$\pm P_{tot}$	<p>Instantaneous total active combined (fundamental and nonfundamental) power. Minus sign indicates generated and plus sign indicates consumed power. See 5.1.5 for definitions.</p> 
P_{tot}^\pm	Recorded total active (fundamental and nonfundamental) power. Minus sign indicates generated and plus sign indicates consumed power. See 5.1.5 for definitions.
$\pm P_{fund}$	Instantaneous active fundamental power, including $\pm P_{fund,p}$ (phase p active fundamental power). Minus sign indicates generated and plus sign indicates consumed power. See 5.1.5 for definitions.
P_{fund}^\pm	Recorded phase active fundamental power, including $P_{fund,p}^\pm$ (phase p active fundamental power). Minus sign indicates generated and plus sign indicates consumed power. See 5.1.5 for definitions.
$\pm P^+, \pm P_{tot}^+$	<p>Instantaneous positive sequence of total active fundamental power. Minus sign indicates generated and plus sign indicates consumed power.</p> <p>See 5.1.5 for definitions.</p>
$P_{tot}^{+\pm}$	<p>Recorded positive sequence of total active fundamental power. Minus sign indicates generated and plus sign indicates positive sequence of consumed power.</p> <p>See 5.1.5 for definitions.</p>
$\pm P_H$	Instantaneous phase active harmonic power, including $\pm P_{Hp}$ (phase p active harmonic power). Minus sign indicates generated and plus sign indicates consumed power. See 5.1.5 for definitions.
P_H^\pm	Recorded phase active harmonics power, including P_{Hp}^\pm (phase p active harmonic power). Minus sign indicates generated and plus sign indicates consumed power. See 5.1.5 for definitions.

$\pm P_{Htot}$ Instantaneous total active harmonic power. Minus sign indicates generated and plus sign indicates consumed power. See 5.1.5 for definitions.

P_{Htot}^{\pm} Recorded total active harmonics power. Minus sign indicates generated and plus sign indicates consumed active power. See 5.1.5 for definitions.

$\pm PF_{ind}$
 $\pm PF_{cap}$ Instantaneous phase combined (fundamental and nonfundamental) power factor, including $\pm PF_{pind/cap}$ (phase p power factor). Minus sign indicates generated power and plus sign indicates consumed power. Suffix *ind/cap* represents inductive/capacitive character.

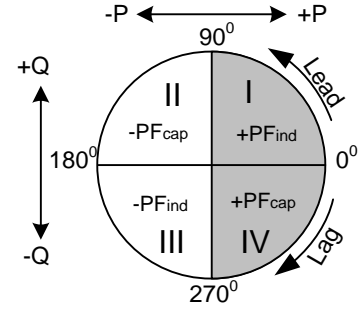

Note: PF = DPF when harmonics are not present. See 5.1.5 for definition.

PF_{ind}^{\pm}
 PF_{cap}^{\pm} Recorded phase combined (fundamental and nonfundamental) power factor.

Minus sign indicates generated power and plus sign indicates consumed power. Suffix *ind/cap* represents inductive/ capacitive character. This parameter is recorded separately for each quadrant as shown on figure.

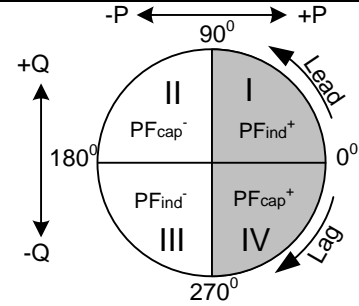

$\pm PFa_{totind}$
 $\pm PFa_{totcap}$ Instantaneous total arithmetic combined (fundamental and nonfundamental) power factor.

Minus sign indicates generated power and plus sign indicates consumed power. Suffix *ind/cap* represents inductive/capacitive character. See 5.1.6 for definition.

PFa_{totind}^{\pm}
 PFa_{totcap}^{\pm} Recorded total arithmetic combined (fundamental and nonfundamental) power factor.

Minus sign indicates generated power and plus sign indicates consumed power. Suffix *ind/cap* represents inductive/capacitive character. This parameter is recorded separately for each quadrant as shown on figure.

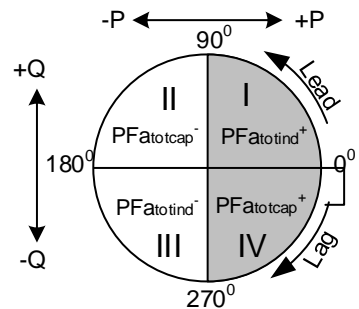

$\pm PFe_{totind}$
 $\pm PFe_{totcap}$ Instantaneous total effective combined (fundamental and nonfundamental) power factor.

Minus sign indicates generated power and plus sign indicates consumed power. Suffix *ind/cap* represents inductive/capacitive character. See 5.1.5 for definition.

PFe_{totind}^{\pm} PFe_{totcap}^{\pm}	<p>Recorded total effective combined (fundamental and nonfundamental) power factor.</p> <p>Minus sign indicates generated power and plus sign indicates consumed power. Suffix <i>ind/cap</i> represents inductive/capacitive character. This parameter is recorded separately for each quadrant as shown on figure.</p>	
$\pm PFV_{totind}$ $\pm PFV_{totcap}$	<p>Instantaneous total vector combined (fundamental and nonfundamental) power factor.</p> <p>Minus sign indicates generated power and plus sign indicates consumed power. Suffix <i>ind/cap</i> represents inductive/capacitive character. See 5.1.6 for definition.</p>	
PFV_{totind}^{\pm} PFV_{totcap}^{\pm}	<p>Recorded total vector combined (fundamental and nonfundamental) power factor.</p> <p>Minus sign indicates generated power and plus sign indicates consumed power. Suffix <i>ind/cap</i> represents inductive/capacitive character. This parameter is recorded separately for each quadrant as shown on figure.</p>	
P_{inv+}	<p>Photovoltaic inverter Active Power positive</p>	
P_{inv-}	<p>Photovoltaic inverter Active Power negative</p>	
P_{dcinv+}	<p>Photovoltaic inverter Active Power DC positive</p>	
P_{dcinv-}	<p>Photovoltaic inverter Active Power DC negative</p>	
S_{acinv+}	<p>Photovoltaic inverter Apparent Power AC positive</p>	
S_{acinv-}	<p>Photovoltaic inverter Apparent Power AC negative</p>	
P_{lt}	<p>Phase long term flicker (2 hours), including P_{ltpg} (phase p to phase g long term voltage flicker) and P_{ltp} (phase p to neutral long-term voltage flicker). See 5.1.10 for definition.</p>	
P_{st}	<p>Short term flicker (10 minutes) including P_{stpg} (phase p to phase g short term voltage flicker) and P_{stp} (phase p to neutral voltage flicker). See 5.1.10 for definition.</p>	
$P_{st(1min)}$	<p>Short term flicker (1 minute) including $P_{st(1min)pg}$ (phase p to phase g short term voltage flicker) and $P_{st(1min)p}$ (phase p to neutral voltage flicker). See 5.1.10 for definition.</p>	
P_{inst}	<p>Instantaneous flicker including P_{instpg} (phase p to phase g instantaneous voltage flicker) and P_{instp} (phase p to instantaneous voltage flicker). See 5.1.10 for definition.</p>	
$\pm N$	<p>Instantaneous combined (fundamental and nonfundamental) nonactive phase power including $\pm N_p$ (phase p nonactive phase power). Minus sign indicates generated and plus sign indicate</p>	

consumed nonactive power. See 5.1.5 for definition.

N_{ind}^{\pm}
 N_{cap}^{\pm}

Recorded phase combined (fundamental and nonfundamental) nonactive power including $N_{cap/indP}$ (phase p nonactive phase power). Suffix *ind/cap* represents inductive/capacitive character. Minus sign indicates generated and plus sign indicates consumed fundamental reactive power. This parameter is recorded separately for each quadrant as shown on figure. See 5.1.5 for definition.

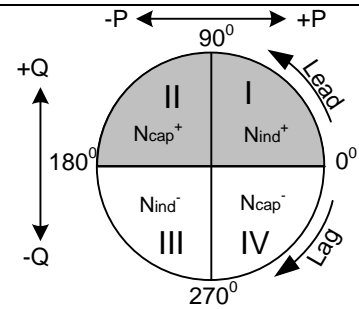

$\pm N_{tot}$

Instantaneous combined (fundamental and nonfundamental) nonactive total vector power. Minus sign indicates generated and plus sign indicate consumed nonactive power. See 5.1.5 for definition.

N_{totind}^{\pm}
 N_{totcap}^{\pm}

Recorded total vector combined (fundamental and nonfundamental) nonactive power. Suffix *ind/cap* represents inductive/capacitive character. Minus sign indicates generated and plus sign indicates consumed combined nonactive power. This parameter is recorded separately for each quadrant as shown on figure. See 5.1.5 for definition.

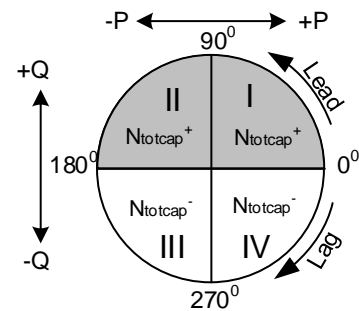

$\pm Na_{tot}$

Instantaneous combined (fundamental and nonfundamental) nonactive total arithmetic power. Minus sign indicates generated and plus sign indicate consumed nonactive power. See 5.1.6 for definition.

Na_{totind}^{\pm}
 Na_{totcap}^{\pm}

Recorded total arithmetic combined (fundamental and nonfundamental) nonactive power. Minus sign indicates generated and plus sign indicates consumed combined nonactive power. This parameter is recorded separately for generated and consumed nonactive power.

$\pm Q_{fund}$

Instantaneous fundamental reactive phase power including $\pm Q_p$ (phase p reactive phase power). Minus sign indicates generated and plus sign indicates consumed fundamental reactive power. See 5.1.5 for definition.

$Q_{fund,ind}^{\pm}$
 $Q_{fund,cap}^{\pm}$

Recorded phase fundamental reactive power. Suffix *ind/cap* represents inductive/capacitive character. Minus sign indicates generated and plus sign indicates consumed fundamental reactive power. This parameter is recorded separately for each quadrant as shown on figure. See 5.1.5 for definition.

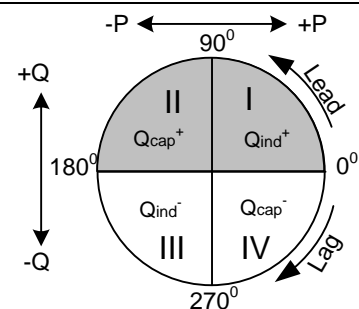

$\pm Q_{\text{fund}_{\text{tot}}}$	Instantaneous fundamental total vector reactive power. Minus sign indicates generated and plus sign indicates consumed fundamental reactive power. See 5.1.6 for definition.
$Q_{\text{fund}_{\text{totind}}^{\pm}}$ $Q_{\text{fund}_{\text{totcap}}^{\pm}}$	Recorded total fundamental vector reactive power. Suffix <i>ind/cap</i> represents inductive/capacitive character. Minus sign indicates generated and plus sign indicates consumed fundamental reactive power. This parameter is recorded separately for each quadrant as shown on figure. See 5.1.6 for definition.
$Q_{\text{afund}_{\text{tot}}}$	Instantaneous fundamental total arithmetic reactive power. See 5.1.6 for definition.
$Q_{\text{afund}_{\text{tot}}}$ $Q_{\text{afund}_{\text{tot}}}$	Recorded fundamental total arithmetic reactive power. See 5.1.6 for definition.
$\pm Q_{\text{totcap}}^{+}$ $\pm Q_{\text{totind}}^{+}$	Instantaneous positive sequence of total fundamental reactive power. Suffix <i>ind/cap</i> represents inductive/capacitive character. Minus sign indicates generated and plus sign indicates consumed reactive power. See 5.1.5 for definition.
$Q_{\text{totind}}^{+\pm}$ $Q_{\text{totcap}}^{+\pm}$	Recorded positive sequence of total fundamental reactive power. Suffix <i>ind/cap</i> represents inductive/capacitive character. Minus sign indicates generated and plus sign indicates consumed reactive power. This parameter is recorded separately for each quadrant.
S	Combined (fundamental and nonfundamental) phase apparent power including S_p (phase p apparent power). See 5.1.5 for definition.
$S_{\text{a}_{\text{tot}}}$	Combined (fundamental and nonfundamental) total arithmetic apparent power. See 5.1.6 for definition.
$S_{\text{e}_{\text{tot}}}$	Combined (fundamental and nonfundamental) total effective apparent power. See 5.1.5 for definition.
$S_{\text{v}_{\text{tot}}}$	Combined (fundamental and nonfundamental) total vector apparent power. See 5.1.6 for definition.
S_{fund}	Phase fundamental apparent power, including S_{fund_p} (phase p fundamental apparent power). See 5.1.5 for definition.
$S_{\text{afund}_{\text{tot}}}$	Fundamental total arithmetic apparent power. See 5.1.6 for definition.
$S_{\text{vfund}_{\text{tot}}}$	Fundamental total vector apparent power. See 5.1.6 for definition.
S_{tot}^{+}	Positive sequence of total fundamental apparent power. See 5.1.5 for definition.
$S_{\text{ufund}_{\text{tot}}}$	Unbalanced fundamental apparent power. See 5.1.5 for definition.
S_N	Phase nonfundamental apparent power, including S_{N_p} (phase p

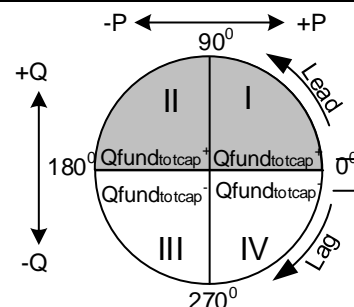

	nonfundamental apparent power). See 5.1.5 for definition.
S_{en}	Total nonfundamental effective apparent power. See 5.1.5 for definition.
S_H	Phase harmonic apparent power, including S_{H_p} (phase p harmonic apparent power). See 5.1.5 for definition.
$S_{eH_{tot}}$	Total harmonic effective apparent power. See 5.1.5 for definition.
THD_I	Total harmonic distortion current (in % or A), including THD_{I_p} (phase p current THD) and THD_{IN} (neutral current THD). See 5.1.8 for definition
THD_U	Total harmonic distortion voltage related (in % or V) including $THD_{U_{pg}}$ (phase p to phase g voltage THD) and THD_{U_p} (phase p to neutral voltage THD). See 5.1.11 for definition.
u^-	Negative sequence voltage ratio (%). See 5.1.11 for definition.
u^0	Zero sequence voltage ratio (%). See 5.1.11 for definition.
U, U_{Rms}	RMS voltage, including U_{pg} (phase p to phase g voltage) and U_p (phase p to neutral voltage). See 5.1.2 for definition.
U_{rmsinv}	Photovoltaic inverter RMS voltage
U_{acinv}	Photovoltaic inverter AC voltage
U_{dcinv}	Photovoltaic inverter DC voltage
U^+	Positive sequence voltage component on three phase systems. See 5.1.11 for definition.
U^-	Negative sequence voltage component on three phase systems. See 5.1.11 for definition.
U^0	Zero sequence voltage component on three phase systems. See 5.1.11 for definition.
U_{Dip}	Minimal $U_{Rms(1/2)}$ voltage measured during dip occurrence
U_{fund}	Fundamental RMS voltage (U_{h_1} on 1 st harmonics), including $U_{fund_{pg}}$ (phase p to phase g fundamental RMS voltage) and U_{fund_p} (phase p to neutral fundamental RMS voltage). See 5.1.8 for definition
U_{h_N}	n^{th} voltage RMS harmonic component including $U_{pg}h_N$ (phase p to phase g voltage n^{th} RMS harmonic component) and U_ph_N (phase p to neutral voltage n^{th} RMS harmonic component). See 5.1.8 for definition.
U_{ih_N}	n^{th} voltage RMS interharmonic voltage component including $U_{pg}ih_N$ (phase p to phase g voltage n^{th} RMS interharmonic component) and U_pih_N (phase p to neutral voltage n^{th} RMS interharmonic component). See 5.1.8 for definition.
U_{Int}	Minimal $U_{Rms(1/2)}$ voltage measured during interrupt occurrence.
U_{Nom}	Nominal voltage, normally a voltage by which network is designated or identified.
U_{Over}	Voltage over-deviation, difference between the measured value and the nominal value of a voltage, only when the measured value is greater than the nominal value. Voltage over-deviation measured

	over recorded interval, expressed in % of nominal voltage including U_{pgOver} (phase p to phase g voltage) and U_{pOver} (phase p to neutral voltage). See 5.1.12 for details.
U_{Pk}	Peak voltage, including U_{pgPk} (phase p to phase g voltage) and U_{pPk} (phase p to neutral voltage)
$U_{Rms(1/2)}$	RMS voltage refreshed each half-cycle, including $U_{pgRms(1/2)}$ (phase p to phase g half-cycle voltage) and $U_{pRms(1/2)}$ (phase p to neutral half-cycle voltage). See 5.1.12 for definition.
U_{Swell}	Maximal $U_{Rms(1/2)}$ voltage measured during swell occurrence.
U_{Sig}	Mains signalling RMS voltage, including U_{Sigpg} (phase p to phase g half-cycle signalling voltage) and U_{Sigp} (phase p to neutral half-cycle signalling voltage). Signalling is a burst of signals, often applied at a non-harmonic frequency, that remotely control equipment. See 5.2.6 for details.
U_{Under}	Voltage under-deviation, difference between the measured value and the nominal value of a voltage, only when the voltage is lower than the nominal value. Voltage under-deviation measured over recorded interval and expressed in % of nominal voltage, including $U_{pgUnder}$ (phase p to phase g voltage) and U_{pUnder} (phase p to neutral voltage). See 5.1.12 for details.
ΔU_{max}	Maximum absolute difference between any of the $U_{Rms(1/2)}$ values during the RVC event and the final arithmetic mean 100/120 $U_{Rms(1/2)}$ value just prior to the RVC event. For poly-phase systems, the ΔU_{max} is the largest ΔU_{max} on any channel. See 5.1.15 for details.
ΔU_{ss}	Absolute difference between the final arithmetic mean 100/120 $U_{Rms(1/2)}$ value just prior to the RVC event and the first arithmetic mean 100/120 $U_{Rms(1/2)}$ value after the RVC event. For poly-phase systems, the ΔU_{ss} is the largest ΔU_{ss} on any channel. See 5.1.15 for details.

2 Description

2.1 Front panel

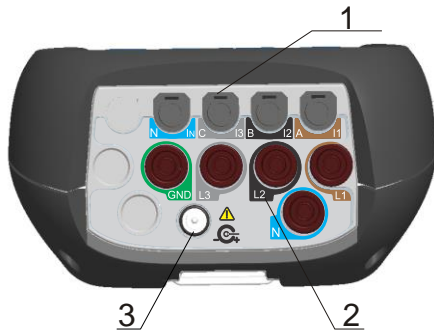

Figure 2: Front panel

Front panel layout:

- | | |
|----------------------------|--|
| 1. LCD | Colour TFT display, 4.3-inch, 480 x 272 pixels. |
| 2. F1 – F4 | Function keys. |
| 3. ARROW keys | Moves cursor and select parameters. |
| 4. ENTER key | Step into submenu. |
| 5. ESC key | Exits any procedure, confirms new settings. |
| 6. SHORTCUT keys | Quick access to main instrument functions. |
| 7. LIGHT key
(BEEP OFF) | Adjust LCD backlight intensity: high/low//off
If the <i>LIGHT</i> key is pressed for more than 1.5 seconds, beeper will be disabled. Press & hold again to enable it. |
| 8. ON-OFF key | Turns on/off the instrument. |
| 9. COVER | Communication ports and microSD card slot protection. |

2.2 Connector panel



- ⚠ Warnings!**
- ⚠ Use safety test leads only!
 - ⚠ Max. permissible nominal voltage between voltage input terminals and ground is $1000 V_{RMS}$!
 - ⚠ Max. short-term voltage of external power supply adapter is 14 V!

Figure 3: Top connector panel

Top connector panel layout:

- 1 Clamp-on current transformers (I_1 , I_2 , I_3 , I_N) input terminals.
- 2 Voltage (L_1 , L_2 , L_3 , N , GND) input terminals.
- 3 12 V external power socket.

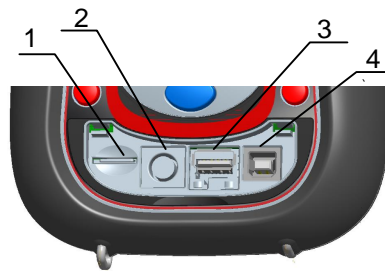

Figure 4: Side connector panel

Side connector panel layout:

- 1 MicroSD card slot.
- 2 GPS serial connector.
- 3 Ethernet connector.
- 4 USB connector.

2.3 Bottom view

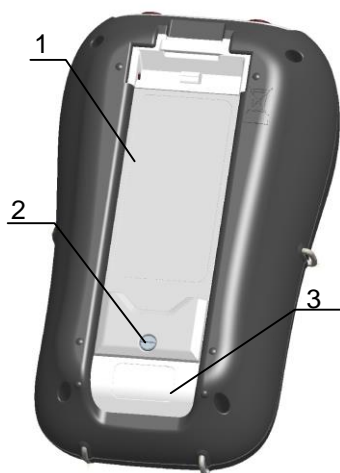

Figure 5: Bottom view

Bottom view layout:

1. Battery compartment cover.
2. Battery compartment screw (unscrew to replace the batteries).
3. Serial number label.

2.4 Accessories

2.4.1 Standard accessories

Table 1: Power Master XT standard accessories

Description	Pieces
Flexible current clamp 3000 A / 300 A / 30 A (A 1227/A 1502)	4
Temperature probe (A 1354)	1
Colour coded test probe	5
Colour coded crocodile clip	5
Colour coded voltage measurement lead	5
USB cable	1
RS232 cable	1
Ethernet cable	1
12 V / 3 A Power supply adapter	1
NiMH rechargeable battery, type HR 6 (AA), 2500 mAh	6
Professional protective waterproof case (A 1685)	1
Compact disc (CD) with PowerView v3.0 and manuals	1

2.4.2 Optional accessories

See the attached sheet for a list of optional accessories that are available on request from your distributor.

3 Operating the instrument

This section describes how to operate the instrument. The instrument front panel consists of a colour LCD display and keypad. Measured data and instrument status are shown on the display. Basic display symbols and keys description is shown on figure below.



Figure 6: Display symbols and keys description

During measurement campaign various screens can be displayed. Most screens share common labels and symbols. These are shown on figure below.



Figure 7: Common display symbols and labels during measurement campaign

3.1 Instrument status bar





















Instruments status bar is placed on the top of the screen. It indicates different instrument states. Icon descriptions are shown on table below.



Figure 8: Instrument status bar

Table 2: Instrument status bar description

	Indicates battery charge level.
	Indicates that charger is connected to the instrument. Batteries will be charged automatically when charger is present.
	Instrument is locked (see section 3.22.6 for details).
	AD converter over range. Selected Nominal voltage or current clamps range is too small.
18:07	Current time.
<u>GPS module status (Optional accessory A 1355):</u>	
	GPS module detected but reporting invalid time and position data. (Searching for satellites or too weak satellite signal).
	GPS time valid – valid satellite GPS time signal.
	Instrument act as host USB, and is ready to accept USB memory stick.

	One of the current clamps has opposite direction from the expected.
<i>Internet connection status (see section 4.3 for details):</i>	
	Internet connection is not available.
	Instrument is connected to the internet and ready for communication.
	Instrument is connected to the PowerView.
<i>Recorder status:</i>	
	General recorder is active, waiting for trigger.
	General recorder is active, recording in progress.
	Waveform recorder is active, waiting for trigger.
	Waveform recorder is active, recording in progress.
	Transient recorder is active, waiting for trigger.
	Transient recorder is active, recording in progress.
	Alarm detected, recording in progress
	Event detected, recording in progress
	Inrush detected, recording in progress
	RVC detected, recording in progress
	Signalling detected, recording in progress
	Transient detected, recording in progress
	Memory list recall. Shown screen is recalled from instrument memory.
	Flagged data mark. While observing recorded data this mark will indicate that observed measurement results for given time interval can be compromised due to interrupt, dip or swells occurrence. See section 5.1.17 for further explanation.
	Signalling voltage is present on voltage line at monitored frequencies. See sections 3.13 and 3.21.4 for further explanation.
	USB stick communication mode. In this mode selected record can be transferred from microSD card to USB stick. USB communication with PC is disabled while in this mode. See section 3.20 for details.

3.2 Instrument keys

Instrument keyboard is divided into four subgroups:

- Function keys
- Shortcut keys
- Menu/zoom manipulation keys: Cursors, Enter, Escape
- Other keys: Light and Power on/off keys

Function keys

















are multifunctional. Their current function is shown at the bottom of the screen and depends on selected instrument function.

Shortcut keys are shown in table below. They provide quick access to the most common instrument functions.

Table 3: Shortcut Keys and other Function keys

	Shows UIF Meter screen from MEASUREMENT submenu
	Shows Power meter screen from MEASUREMENT submenu
	Shows Harmonics meter screen from MEASUREMENT submenu
	Shows Connection Setup screen from MEASUREMENT SETUP submenu
	Shows Phase diagram screen from MEASUREMENT submenu
	Hold  key for 2 seconds to trigger WAVEFORM SNAPSHOT. Instrument will record all measured parameters into file, which can be then analysed by PowerView.
	Set backlight intensity (high/low/off).
	Hold  key for 2 s to disable/enable beeper sound signals.
	Switch On/off the instrument. Note: instrument will not power off if any recorder is active. Note: Hold key for 5 seconds in order to reset instrument, in case of failure.

Cursor, Enter and Escape keys are used for moving through instrument menu structure, entering various parameters. Additionally, cursor keys are used for zooming graphs and moving graph cursors.

3.3 Instrument memory (microSD card)

Power master XT use microSD card for storing records. Prior instrument use, microSD card should be formatted to a single partition FAT32 file system and inserted into the instrument, as shown on figure below.

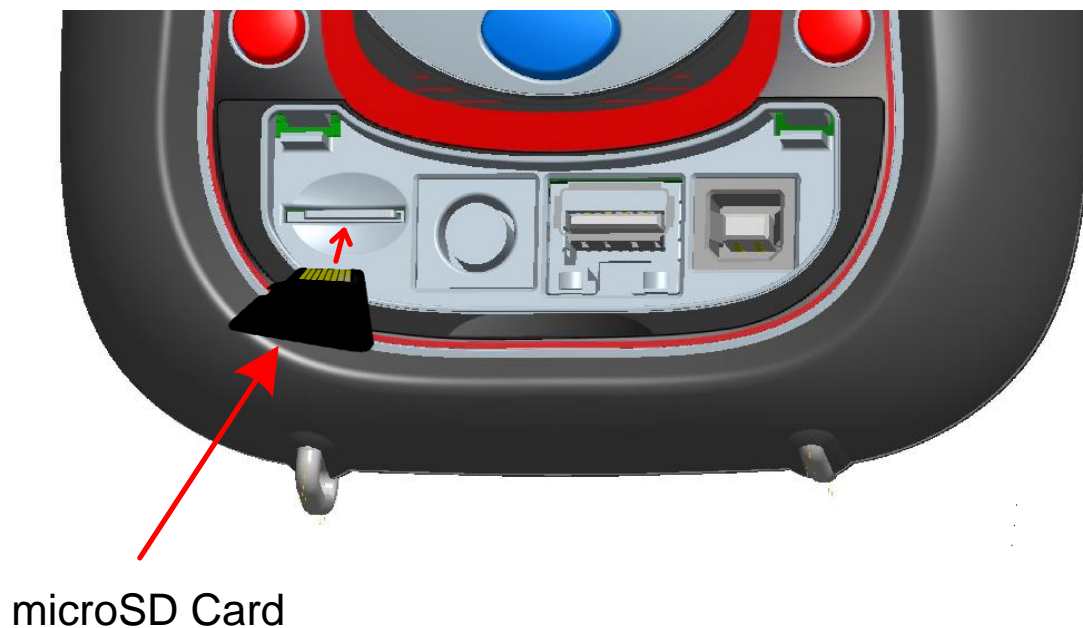

Figure 9: Inserting microSD card

1. Open instrument cover
2. Insert microSD card into a slot on the instrument (card should be putted upside down, as shown on figure)
3. Close instrument cover

Note: Do not turn off the instrument while microSD card is accessed:

- during record session
- observing recorded data in MEMORY LIST menu

Doing so may cause data corruption, and permanent data lost.

Note: SD Card should have single FAT32 partition. Do not use SD cards with multiple partitions.

3.4 Instrument Main Menu

After powering on the instrument, the “MAIN MENU” is displayed. From this menu all instrument functions can be selected.

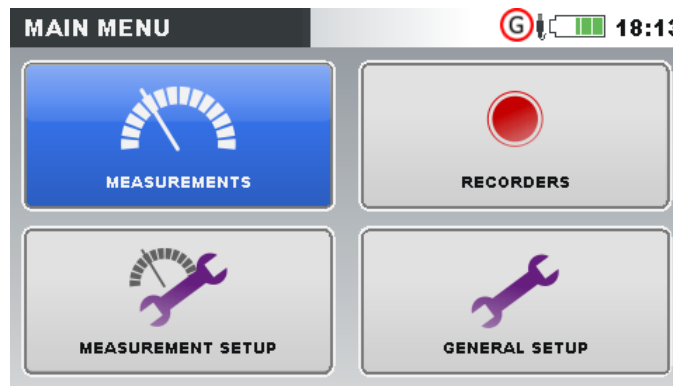

Figure 10: “MAIN MENU”

Table 4: Instrument Main menu







	MEASUREMENT submenu. Provide access to various instrument measurement screens
	RECORDER submenu. Provide access to instrument recorders configuration and storage.
	MEASUREMENT SETUP submenu. Provide access to the measurement settings.
	GENERAL SETUP submenu. Provide access to the various instrument settings.

Table 5: Keys in Main menu

	Selects submenu.
	Enters selected submenu.

3.4.1 Instrument submenus

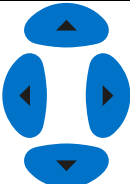
By pressing ENTER key in Main menu, user can select one of four submenus:

- Measurements – set of basic measurement screens,
- Recorders – setup and view of various recordings,
- Measurement setup – measurement parameters setup,
- General setup – configuring common instrument settings.

List of all submenus with available functions are presented on following figures.

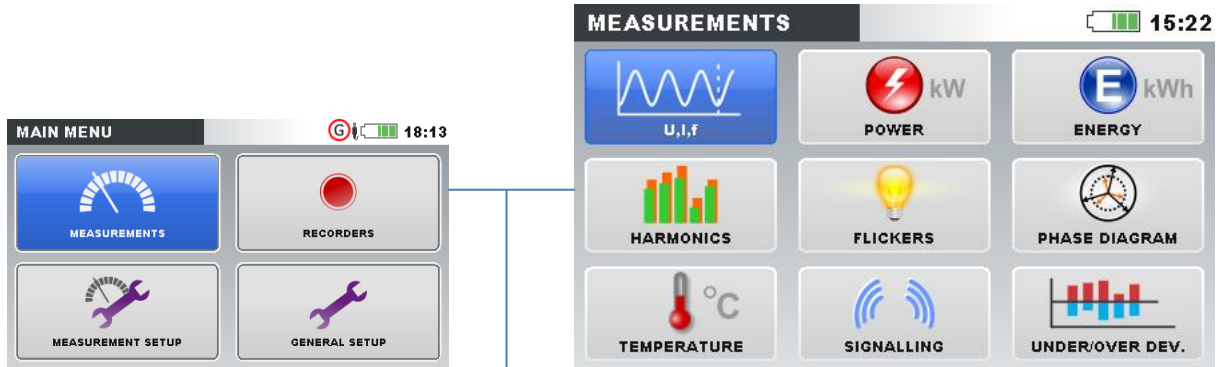

Figure 11: Measurements submenu

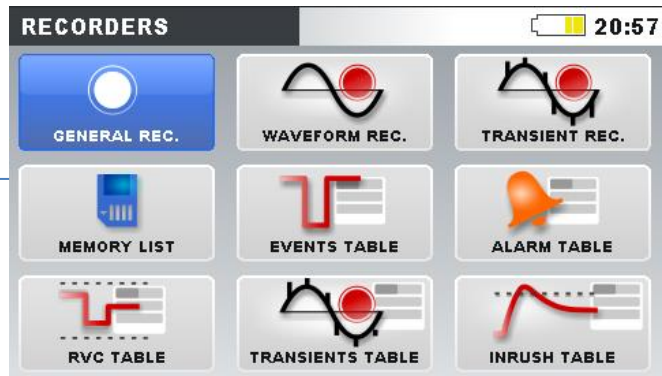

Figure 12: Recorders submenu

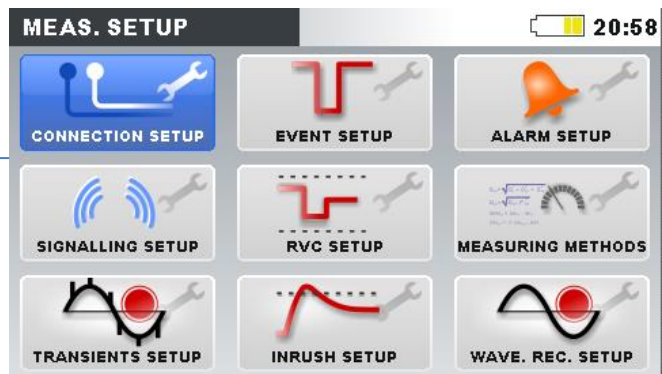

Figure 13: Measurement setup submenu



Figure 14: General setup submenu

Table 6: Keys in submenus

	Selects function within each submenu.
	Enters selected function.
	Returns to the "MAIN MENU".

3.5 U, I, f

Voltage, current and frequency parameters can be observed in the "U, I, f" screens. Measurement results can be viewed in a tabular (METER) or a graphical form (SCOPE, TREND). TREND view is active only in RECORDING mode. See section 3.14 for details.

3.5.1 Meter

By entering U, I, f option, the U, I, f – METER tabular screen is shown (see figures below).

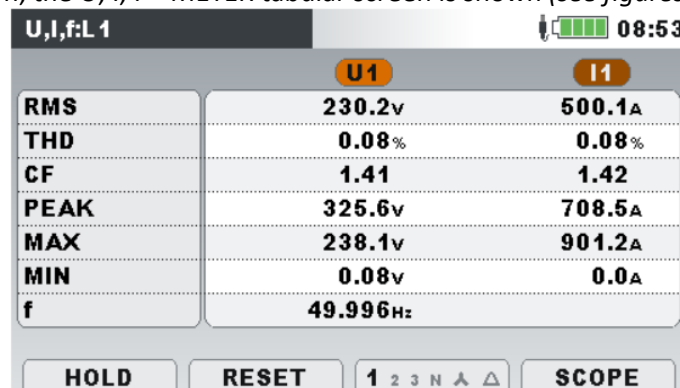

Figure 15: U, I, f meter phase table screens (L1, L2, L3, N)

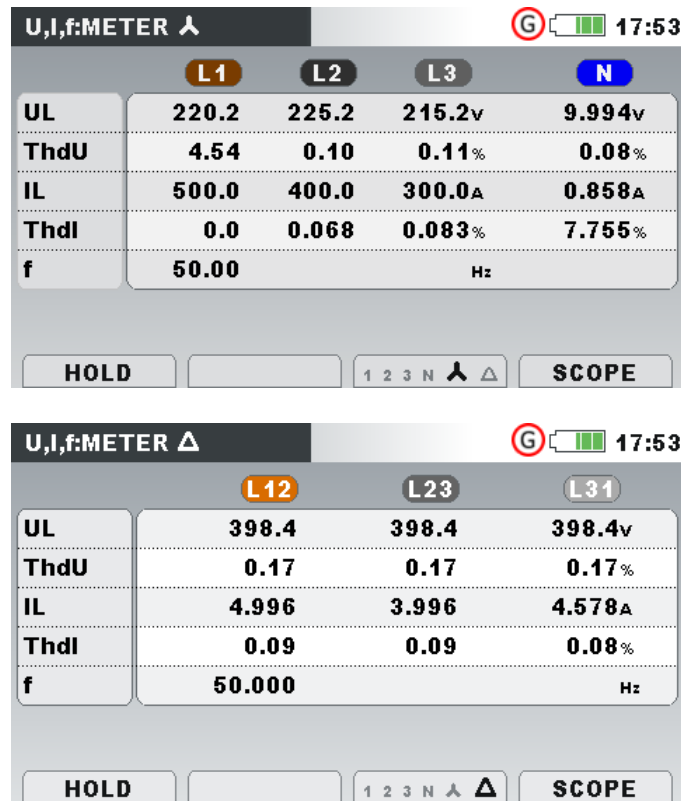

Figure 16: U, I, f meter summary table screens

In those screens on-line voltage and current measurements are shown. Descriptions of symbols and abbreviations used in this menu are shown in table below.

Table 7: Instrument screen symbols and abbreviations

RMS	
UL	True effective value U_{Rms} and I_{Rms}
IL	
THD	
ThdU	Total harmonic distortion THD_U and THD_I
ThdI	
CF	Crest factor CF_U and CF_I
PEAK	Peak value U_{Pk} and I_{Pk}
MAX	Maximal $U_{Rms(1/2)}$ voltage and maximal $I_{Rms(1/2)}$ current, measured after RESET (key: F2)
MIN	Minimal $U_{Rms(1/2)}$ voltage and minimal $I_{Rms(1/2)}$ current, measured after RESET (key: F2)
f	Frequency on reference channel



Note: In case of overloading current or overvoltage on AD converter, icon  will be displayed in the status bar of the instrument.

Table 8: Keys in Meter screens

F1	HOLD	Holds measurement on display. Hold clock time will be displayed in the right top corner.
	RUN	Runs held measurement.
F2	RESET	Resets MAX and MIN values ($U_{Rms(1/2)}$ and $I_{Rms(1/2)}$).
F3	1 2 3 N ^ Δ	Shows measurements for phase L1.
	1 2 3 N ^ Δ	Shows measurements for phase L2.
	1 2 3 N ^ Δ	Shows measurements for phase L3.
	1 2 3 N ^ Δ	Shows measurements for neutral channel.
	1 2 3 N ^ Δ	Shows measurements for all phases.
	1 2 3 N ^ Δ	Shows measurements for all phase to phase voltages.
	12 23 31 Δ	Shows measurements for phase to phase voltage L12.
	12 23 31 Δ	Shows measurements for phase to phase voltage L23.
	12 23 31 Δ	Shows measurements for phase to phase voltage L31.
	12 23 31 Δ	Shows measurements for all phase to phase voltages.
F4	METER	Switches to METER view.
	SCOPE	Switches to SCOPE view.
	TREND	Switches to TREND view (available only during recording).
		Triggers Waveform snapshot.
ESC		Returns to the "MEASUREMENTS" submenu.

3.5.2 Scope

Various combinations of voltage and current waveforms can be displayed on the instrument, as shown below.

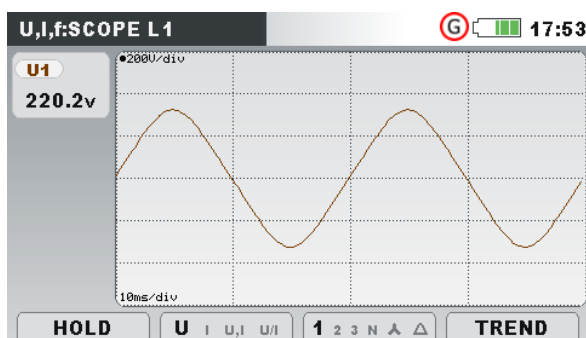

Figure 17: Voltage only waveform

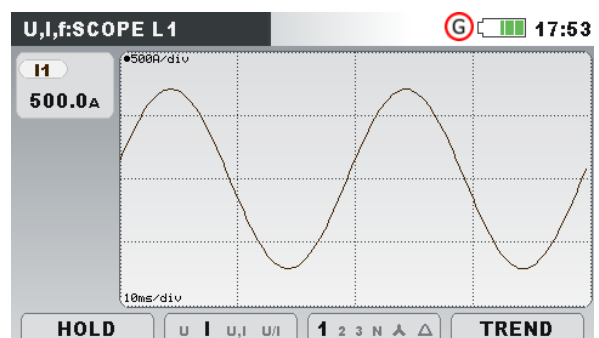

Figure 18: Current only waveform

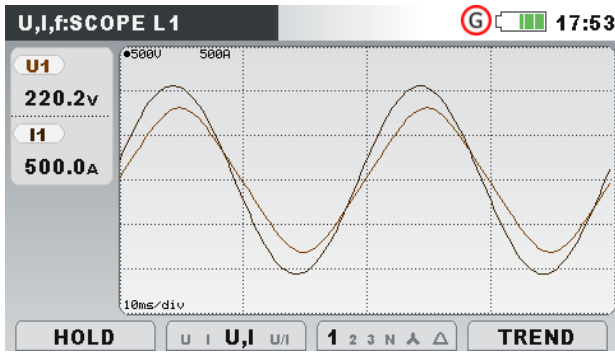

Figure 19: Voltage and current waveform (single mode)

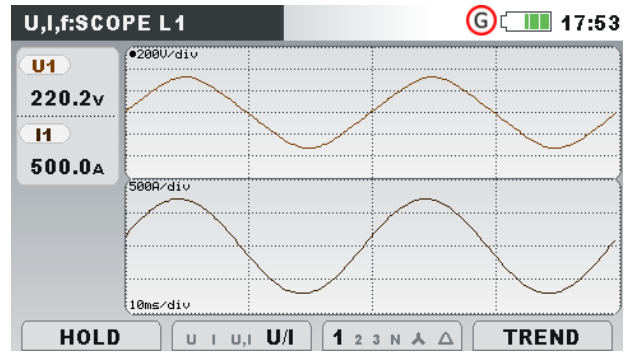







Figure 20: Voltage and current waveform (dual mode)

Table 9: Instrument screen symbols and abbreviations

U1, U2, U3, Un	True effective value of phase voltage: U_1, U_2, U_3, U_N
U12, U23, U31	True effective value of phase-to-phase (line) voltage: U_{12}, U_{23}, U_{31}
I1, I2, I3, In	True effective value of current: I_1, I_2, I_3, I_N

Table 10: Keys in Scope screens

F1	HOLD	Holds measurement on display.
	RUN	Runs held measurement.
F2	U I U,I U/I	Selects which waveforms to show: Shows voltage waveform.
	U I U,I U/I	Shows current waveform.
	U I U,I U/I	Shows voltage and current waveform (single graph).
	U I U,I U/I	Shows voltage and current waveform (dual graph).
F3	1 2 3 N A Δ	Selects between phase, neutral, all-phases and line view: Shows waveforms for phase L1.
	1 2 3 N A Δ	Shows waveforms for phase L2.
	1 2 3 N A Δ	Shows waveforms for phase L3.
	1 2 3 N A Δ	Shows waveforms for neutral channel.
	1 2 3 N A Δ	Shows all phase waveforms.
	1 2 3 N A Δ	Shows all phase-to-phase waveforms.
	12 23 31 Δ	Shows waveforms for phase L12.
	12 23 31 Δ	Shows waveforms for phase L23.
	12 23 31 Δ	Shows waveforms for phase L31.
12 23 31 Δ	Shows all phase waveforms.	
F4	METER	Switches to METER view.
	SCOPE	Switches to SCOPE view.

TREND	Switches to TREND view (available only during recording).
	Selects which waveform to zoom (only in U/I or U+I).
	Sets vertical zoom.
	Sets horizontal zoom.
	Triggers Waveform snapshot.
	Returns to the "MEASUREMENTS" submenu.

3.5.3 Trend

While GENERAL RECORDER is active, TREND view is available (see section 3.14 for instructions how to start recorder).

3.5.4 Voltage and current trends

Current and voltage trends can be observed by cycling function key F4 (METER-SCOPE-TREND).

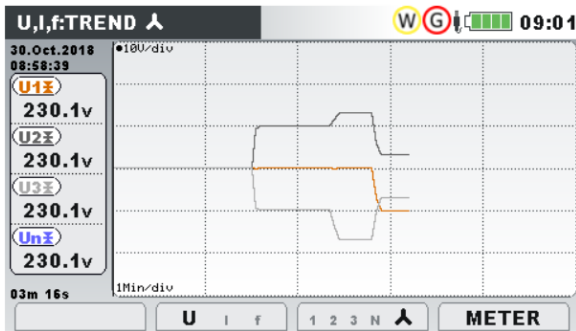

Figure 21: Voltage trend (all voltages)



Figure 22: Voltage trend (single voltage)

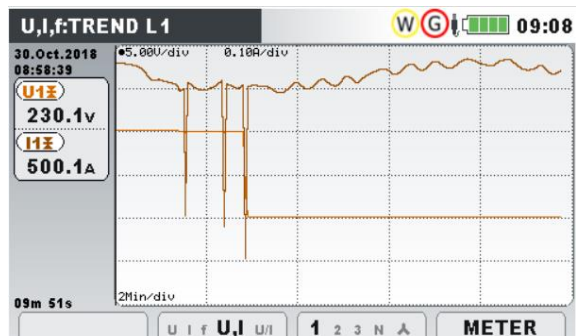

Figure 23: Voltage and current trend (single mode)

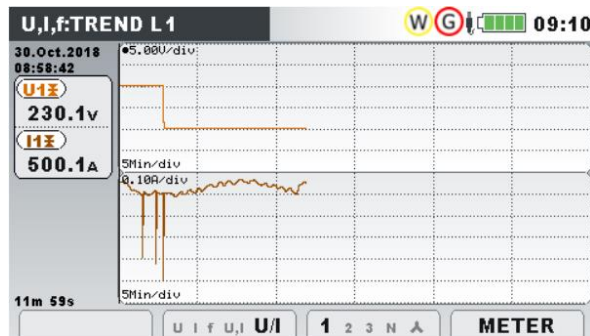

Figure 24: Voltage and current trend (dual mode)

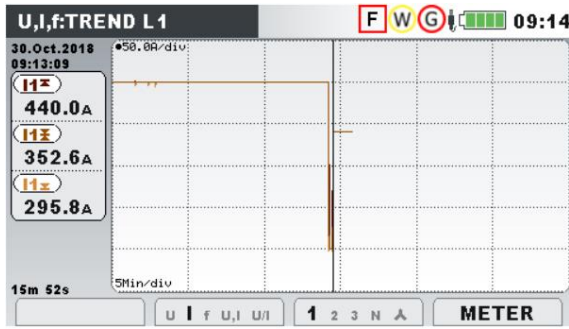

Figure 25: Trends of all currents

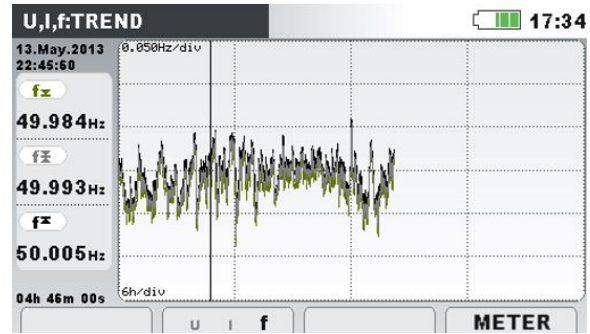

Figure 26: Frequency trend

Table 11: Instrument screen symbols and abbreviations

U1, U2, U3, Un, U12, U23, U31	Maximal (⚡), average (⚡) and minimal (⚡) value of phase RMS voltage U_1, U_2, U_3, U_N or line voltage U_{12}, U_{23}, U_{31} for time interval (IP) selected by cursor.
I1, I2, I3, In	Maximal (⚡), average (⚡) and minimal (⚡) value of current I_1, I_2, I_3, I_N for time interval (IP) selected by cursor.
f	Maximal (⚡), active average (⚡) and minimal (⚡) value of frequency at synchronization channel for time interval (IP) selected by cursor.
10.May.2013 02:02:00	Timestamp of interval (IP) selected by cursor.
32m 00s	Current GENERAL RECORDER time (d - days, h - hours, m - minutes, s - seconds)

Table 12: Keys in Trend screens

		Selects between the following options:
F2	U I f U, I U/I	Shows voltage trend.
	U I f U, I U/I	Shows current trend.
	U I f U, I U/I	Shows frequency trend.
	U I f U, I U/I	Shows voltage and current trend (single mode).
	U I f U, I U/I	Shows voltage and current trend (dual mode).
F3		Selects between phases, neutral channel, all-phases view:
	1 2 3 N ^	Shows trend for phase L1.
	1 2 3 N ^	Shows trend for phase L2.
	1 2 3 N ^	Shows trend for phase L3.
	1 2 3 N ^	Shows trend for neutral channel.
	1 2 3 N ^	Shows all phases trends.
	12 23 31 Δ	Shows trend for phases L12.
	12 23 31 Δ	Shows trend for phases L23.
	12 23 31 Δ	Shows trend for phases L31.
12 23 31 Δ	Shows all phase-to-phase trends.	

	METER	Switches to METER view.
	SCOPE	Switches to SCOPE view.
	TREND	Switches to TREND view.
		Moves cursor and selects time interval (IP) for observation.
	ESC	Returns to the "MEASUREMENTS" submenu.

3.6 Power

In POWER screens instrument shows measured power parameters. Results can be seen in a tabular (METER) or a graphical form (TREND). TREND view is active only while GENERAL RECORDER is active. See section 3.14 for instructions how to start recorder. In order to fully understand meanings of particular power parameter see sections 5.1.5.

Note: Power Master XT always saves data according IEEE 1459 and data presentation could be also selected under PowerView.

3.6.1 Meter

By entering POWER option from Measurements submenu, the tabular POWER (METER) screen is shown (see figure below). Which measurement is present on display depends on following settings:

- Power measurement method: Modern (IEEE 1459), Classic (Vector) or Classic (Arithmetic) – see section 3.21.6
- Connection type: 1W, 2W, 3W...
- Selected VIEW: Combined, Fundamental or Nonfundamental

	L1	L2	L3	TOT.
P	99.58	149.4	199.1	448.1 MW
N	61.87	86.17	114.8	262.9 Mvar
S	117.2	172.5	229.9	537.6 MVA
PF	0.85i	0.87i	0.87i	0.83i

Figure 27: Power measurements summary (combined)

	L1	L2	L3	TOT.
P	99.36	149.1	198.7	447.2 MW
Q	57.31	86.01	114.6	257.9 Mvar
S	114.7	172.2	229.4	516.3 MVA
DPF	0.87i	0.87i	0.87i	0.87i

Figure 29: Power measurements summary (fundamental)

	L1	L2	L3	TOT.
Sn	0.256	0.257	0.261	53.65 kVA
Di	0.172	0.173	0.175	36.76 kvar
Dv	0.190	0.190	0.193	39.07 kvar
PH	0.408	0.407	0.427	1.241 kW

Figure 28: Power measurements summary (nonfundamental)

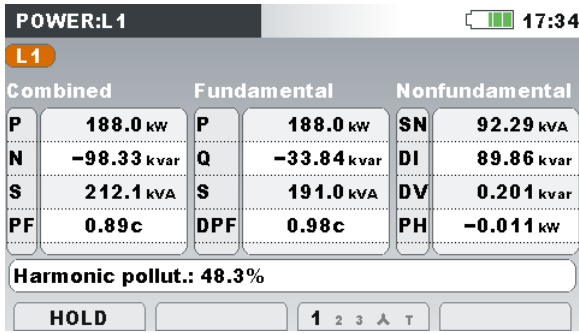

Figure 30: Detailed power measurements at phase L1

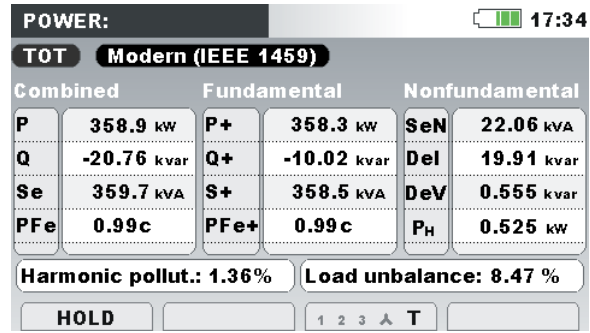

Figure 31: Detailed total power measurements



Description of symbols and abbreviations used in POWER (METER) screens are shown in table below.

Table 13: Instrument screen symbols and abbreviations (see 5.1.5 for details) – instantaneous values

P	Depending on the screen position: In Combined column: Combined (fundamental and nonfundamental) active power ($\pm P_1, \pm P_2, \pm P_3, \pm P_{tot}$) In Fundamental column: Fundamental active phase power ($\pm P_{fund_1}, \pm P_{fund_2}, \pm P_{fund_3}$)
N	Combined (fundamental and nonfundamental) nonactive phase power ($\pm N_1, \pm N_2, \pm N_3$) and nonactive total vector ($\pm N_{tot}$)
Na	Combined (fundamental and nonfundamental) nonactive arithmetic total power ($\pm Na_{tot}$)
Q	Fundamental reactive phase power ($\pm Q_{fund_1}, \pm Q_{fund_2}, \pm Q_{fund_3}$)
Qa	Fundamental total arithmetic reactive power ($Qa_{fund_{tot}}$)
Qv	Fundamental total vector reactive power ($\pm Qv_{fund_{tot}}$)
S	Depending on the screen position: In Combined column: Combined (fundamental and nonfundamental) apparent phase power (S_1, S_2, S_3) In Fundamental column: Fundamental apparent phase power ($S_{fund_1}, S_{fund_2}, S_{fund_3}$)
Sa	Depending on the screen position: In Combined column: Combined (fundamental and nonfundamental) total arithmetic apparent power (Sa_{tot}) In Fundamental column: Fundamental total arithmetic apparent power ($Sa_{fund_{tot}}$)
Sv	Depending on the screen position: In Combined column: Combined (fundamental and nonfundamental) total vector apparent power (Sv_{tot}) In Fundamental column: Fundamental total vector apparent power ($Sv_{fund_{tot}}$)
P+	Positive sequence of total active fundamental power ($\pm P^+_{tot}$)

Q+	Positive sequence of total reactive fundamental power ($\pm Q_{tot}^+$)
S+	Positive sequence of total apparent fundamental power ($\pm S_{tot}^+$)
DPF+	Positive sequence power factor (fundamental, total)
Se	Combined (fundamental and nonfundamental) total effective apparent power (Se_{tot})
SN	Phase nonfundamental apparent power (SN_1, SN_2, SN_3)
Sen	Total effective nonfundamental apparent power (Sen_{tot})
Di	Phase current distortion power (DI_1, DI_2, DI_3)
Dei	Total effective current distortion power (Dei_{tot})
Dv	Phase voltage distortion power (DV_1, DV_2, DV_3)
Dev	Total effective voltage distortion power (Dev_{tot})
PH	Phase and total harmonic active power ($P_{H1}^+, P_{H2}^+, P_{H3}^+, \pm P_{Htot}$)
PF	Phase combined (fundamental and nonfundamental) power factor ($\pm PF_1, \pm PF_2, \pm PF_3$)
PFa	Total arithmetic combined (fundamental and nonfundamental) power factor ($\pm PFa$)
PFe	Total effective combined (fundamental and nonfundamental) power factor ($\pm PFe$)
PFv	Total vector combined (fundamental and nonfundamental) power factor ($\pm PFv$).
DPF	Phase fundamental power factor ($\pm DPF_1, \pm DPF_2, \pm DPF_3$) and positive sequence total power factor ($\pm DPF^+$)
DPFa	Total arithmetic fundamental power factor ($\pm DPFa$).
DPFv	Total vector fundamental power factor ($\pm DPFv$).
Harmonic Pollut.	Harmonic pollution according to the standard IEEE 1459
Load unbalance	Load unbalance according to the standard IEEE 1459

Table 14: Keys in Power (METER) screens

	HOLD	Holds measurement on display. Hold clock time will be displayed in the right top corner.
	RUN	Runs held measurement.
	VIEW	Switches between Combined, Fundamental and Nonfundamental view.
	1 2 3 ▲ T	Shows measurements for phase L1.
	1 2 3 ▲ T	Shows measurements for phase L2.
	1 2 3 ▲ T	Shows measurements for phase L3.
	1 2 3 ▲ T	Shows brief view on measurements on all phases in a single screen.

1 2 3 T	Shows measurement results for TOTAL power measurements.
METER	Switches to METER view.
F4 TREND	Switches to TREND view (available only during recording).
	Triggers Waveform snapshot.
ESC	Returns to the "MEASUREMENTS" submenu.

3.6.2 Trend

During active recording TREND view is available (see section 3.14 for instructions how to start GENERAL RECORDER).

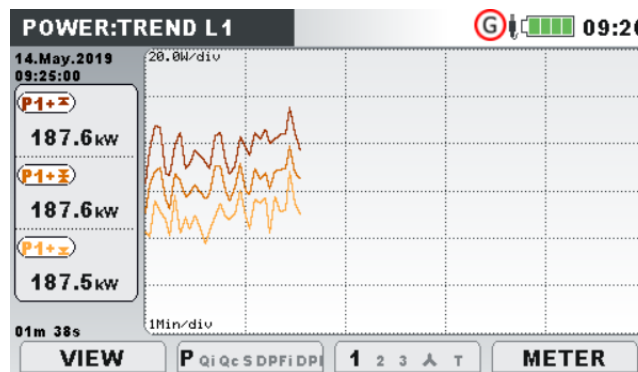

Figure 32: Power trend screen

Table 15: Instrument screen symbols and abbreviations

P1±, P2±, P3±, P±±	View: Combined power Maximal (☒), average (☒) and minimal (☒) value of consumed ($P_{1+}, P_{2+}, P_{3+}, P_{tot+}$) or generated ($P_{1-}, P_{2-}, P_{3-}, P_{tot-}$) active combined power for time interval (IP) selected by cursor.
P1±, P2±, P3±, P±±	View: Fundamental power Maximal (☒), average (☒) and minimal (☒) value of consumed ($Pfund_1+, Pfund_2+, Pfund_3+, P_{tot+}$) or generated ($Pfund_1-, Pfund_2-, Pfund_3-, P_{tot-}$) active fundamental power for time interval (IP) selected by cursor.
Ni1±, Ni2±, Ni3±, Nit±	View: Combined power Maximal (☒), average (☒) and minimal (☒) value of consumed ($N_{1ind+}, N_{2ind+}, N_{3ind+}, N_{totind+}$) or generated ($N_{1ind-}, N_{2ind-}, N_{3ind-}, N_{totind-}$) inductive combined nonactive power for time interval (IP) selected by cursor.
Nc1±, Nc2±, Nc3±, Nct±	View: Combined power Maximal (☒), average (☒) and minimal (☒) value of consumed ($N_{1cap+}, N_{2cap+}, N_{3cap+}, N_{totcap+}$) or generated ($N_{1cap-}, N_{2cap-}, N_{3cap-}, N_{totcap-}$) capacitive combined nonactive power for time interval (IP) selected by cursor.
S1, S2, S3, Se	View: Combined power Maximal (☒), average (☒) and minimal (☒) value of combined apparent power ($S_1, S_2, S_3, S_{e_{tot}}$) for time interval (IP) selected by cursor.

S1, S2, S3, S+	<p>View: Fundamental power</p> <p>Maximal (\mathbb{A}), average (\mathbb{X}) and minimal (\mathbb{V}) value of fundamental apparent power ($Sfund_1, Sfund_2, Sfund_3, S_{tot}^+$) for time interval (IP) selected by cursor.</p>
PFI1 \pm , PFI2 \pm , PFI3 \pm , PFIT \pm	<p>View: Combined power</p> <p>Maximal (\mathbb{A}), average (\mathbb{X}) and minimal (\mathbb{V}) value of inductive power factor (1st quadrant: $PF_{1ind}^+, PF_{2ind}^+, PF_{3ind}^+, PF_{totind}^+$ and 3rd quadrant: $PF_{1ind}^-, PF_{2ind}^-, PF_{3ind}^-, PF_{totind}^-$) for time interval (IP) selected by cursor.</p>
PFc1 \pm , PFc2 \pm , PFc3 \pm , PFct \pm	<p>View: Combined power</p> <p>Maximal (\mathbb{A}), average (\mathbb{X}) and minimal (\mathbb{V}) value of capacitive power factor (4th quadrant: $PF_{1cap}^+, PF_{2cap}^+, PF_{3cap}^+, PF_{totcap}^+$ and 2nd quadrant: $PF_{1cap}^-, PF_{2cap}^-, PF_{3cap}^-, PF_{totcap}^-$) for time interval (IP) selected by cursor.</p>
Qi1 \pm , Qi2 \pm , Qi3 \pm , Q+i \pm	<p>View: Fundamental power</p> <p>Maximal (\mathbb{A}), average (\mathbb{X}) and minimal (\mathbb{V}) value of consumed ($Q_{1ind}^+, Q_{2ind}^+, Q_{3ind}^+, Q_{totind}^+$) or generated ($Q_{1ind}^-, Q_{2ind}^-, Q_{3ind}^-, Q_{totind}^-$) fundamental reactive inductive power for time interval (IP) selected by cursor.</p>
Qc1 \pm , Qc2 \pm , Qc3 \pm , Q+c \pm	<p>View: Fundamental power</p> <p>Maximal (\mathbb{A}), average (\mathbb{X}) and minimal (\mathbb{V}) value of consumed ($Q_{1cap}^+, Q_{2cap}^+, Q_{3cap}^+, Q_{captot}^+$) or generated ($Q_{1cap}^-, Q_{2cap}^-, Q_{3cap}^-, Q_{captot}^-$) fundamental reactive capacitive power for time interval (IP) selected by cursor.</p>
DPFI1 \pm , DPFI2 \pm , DPFI3 \pm , DPFI+it \pm	<p>View: Fundamental power</p> <p>Maximal (\mathbb{A}), average (\mathbb{X}) and minimal (\mathbb{V}) value of inductive displacement power factor (1st quadrant: $DPF_{1ind}^+, DPF_{2ind}^+, DPF_{3ind}^+, DPF_{totind}^+$, and 3rd quadrant: $DPF_{1ind}^-, DPF_{2ind}^-, DPF_{3ind}^-, DPF_{totind}^-$) for time interval (IP) selected by cursor.</p>
DPFc1 \pm , DPFc2 \pm , DPFc3 \pm , DPF+ct \pm	<p>View: Fundamental power</p> <p>Maximal (\mathbb{A}), average (\mathbb{X}) and minimal (\mathbb{V}) value of capacitive displacement power factor (4th quadrant: $DPF_{1cap}^+, DPF_{2cap}^+, DPF_{3cap}^+, DPF_{totcap}^+$, and 2nd quadrant: $DPF_{1cap}^-, DPF_{2cap}^-, DPF_{3cap}^-, DPF_{totcap}^-$) for time interval (IP) selected by cursor.</p>
Sn1, Sn2, Sn3, Sen	<p>View: Nonfundamental power</p> <p>Maximal (\mathbb{A}), average (\mathbb{X}) and minimal (\mathbb{V}) value of consumed or generated nonfundamental apparent power ($SN_1, SN_2, SN_3, SEN_{tot}$) for time interval (IP) selected by cursor.</p>
Di1, Di2, Di3, Dei	<p>View: Nonfundamental power</p> <p>Maximal (\mathbb{A}), average (\mathbb{X}) and minimal (\mathbb{V}) value of consumed or generated phase current distortion power ($DI_1, DI_2, DI_3, DEI_{tot}$) for time interval (IP) selected by cursor.</p>
Dv1, Dv2, Dv3, Dev	<p>View: Nonfundamental power</p> <p>Maximal (\mathbb{A}), average (\mathbb{X}) and minimal (\mathbb{V}) value of consumed or generated phase voltage distortion power ($DV_1, DV_2, DV_3, DEV_{tot}$) for time interval (IP) selected by cursor.</p>
Ph1 \pm , Ph2 \pm , Ph3 \pm , Pht \pm	<p>View: Nonfundamental power</p> <p>Maximal (\mathbb{A}), average (\mathbb{X}) and minimal (\mathbb{V}) value of consumed ($P_{H1}^+, P_{H2}^+, P_{H3}^+, P_{Htot}^+$) or generated ($P_{H1}^-, P_{H2}^-, P_{H3}^-, P_{Htot}^-$) active harmonic power for time interval (IP) selected by cursor.</p>

Table 16: Keys in Power (TREND) screens

Selects which measurement should instrument represent on graph:

- Consumed or Generated
Measurements related to consumed (suffix: +) or generated power (suffix: -).
- Combined, Fundamental or Nonfundamental
Measurement related to fundamental power, nonfundamental power or combined.

F1

VIEW

Keys in VIEW window:

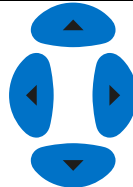

Selects option.



Confirms selected option.



Exits selection window without change.

If Combined power is selected:

P Ni Nc S PFI Pfc

Shows combined active power trend.

P Ni Nc S PFI Pfc

Shows combined inductive nonactive power trend.

P Ni Nc S PFI Pfc

Shows combined capacitive nonactive power trend.

P Ni Nc S PFI Pfc

Shows combined apparent power trend.

P Ni Nc S PFI Pfc

Shows inductive power factor trend.

P Ni Nc S Pfi PFC

Shows capacitive power factor trend.

If Fundamental power is selected:

P Qi Qc S DPFI DPfc

Shows fundamental active power trend.

P Qi Qc S DPFI DPfc

Shows fundamental inductive reactive power trend.

P Qi Qc S DPFI DPfc

Shows fundamental capacitive reactive power trend.

P Qi Qc S DPFI DPfc

Shows fundamental apparent power trend.

P Qi Qc S DPFI DPfc

Shows inductive displacement power factor trend.

P Qi Qc S DPfi DPFC

Shows capacitive displacement power factor trend.

If Nonfundamental power is selected:

Sn Di Dv Ph

Shows nonfundamental apparent power trend.

Sn Di Dv Ph

Shows nonfundamental current distortion power.

Sn Di DV Ph

Shows nonfundamental voltage distortion power.

Sn Di Dv Ph

Shows nonfundamental active power.

Selects between phase, all-phases and Total power view:

F3

1 2 3 ^ T

Shows power parameters for phase L1.

1 2 3 ^ T

Shows power parameters for phase L2.

1 2 3 ^ T

Shows power parameters for phase L3.

	Shows power parameters for phases L1, L2 and L3 on the same graph.
	Shows Total power parameters.
	METER Switches to METER view.
	TREND Switches to TREND view (available only during recording).
	Moves cursor and selects time interval (IP) for observation.
	Returns to the "MEASUREMENTS" submenu.

3.7 Energy

3.7.1 Meter

Instrument shows status of energy counters in energy menu. Results can be seen in a tabular (METER) form. Energy measurement is active only if GENERAL RECORDER is active. See section 3.14 for instructions how to start GENERAL RECORDER. The meter screens are shown on figures below.

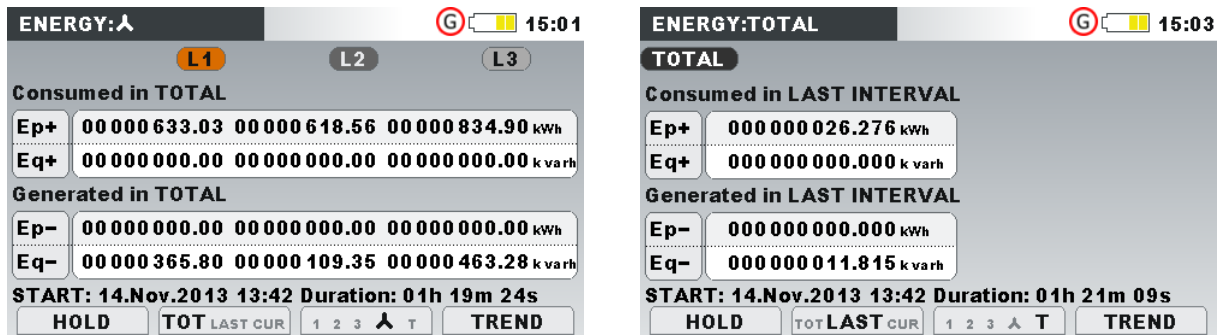

Figure 33: Energy counters screen

Table 17: Instrument screen symbols and abbreviations

Ep+	Consumed (+) phase (Ep ₁ ⁺ , Ep ₂ ⁺ , Ep ₃ ⁺) or total (Ep _{tot} ⁺) active energy
Ep-	Generated (-) phase (Ep ₁ ⁻ , Ep ₂ ⁻ , Ep ₃ ⁻) or total (Ep _{tot} ⁻) active energy
Eq+	Consumed (+) phase (Eq ₁ ⁺ , Eq ₂ ⁺ , Eq ₃ ⁺) or total (Eq _{tot} ⁺) fundamental reactive energy
Eq-	Generated (-) phase (Eq ₁ ⁻ , Eq ₂ ⁻ , Eq ₃ ⁻) or total (Eq _{tot} ⁻) fundamental reactive energy
Start	Recorder start time and date
Duration	Recorder elapsed time

Table 18: Keys in Energy (METER) screens

	HOLD	Holds measurement on display.
	RUN	Runs held measurement.
	TOT LAST CUR	Shows energy registers for whole record.

	TOT LAST CUR	Shows energy registers for last interval.
	TOT LAST CUR	Shows energy registers for current interval.
F3	1 2 3 ^ T	Shows energy parameters for phase L1.
	1 2 3 ^ T	Shows energy parameters for phase L2.
	1 2 3 ^ T	Shows energy parameters for phase L3.
	1 2 3 ^ T	Shows all phases energy.
	1 2 3 ^ T	Shows energy parameters for Totals.
	METER	Switches to METER view.
F4	TREND	Switches to TREND view.
	EFF	Switches to EFFICIENCY view.
		Triggers Waveform snapshot.
	ESC	Returns to the "MEASUREMENTS" submenu.

3.7.2 Trend

TREND view is available only during active recording (see section 3.14 for instructions how to start GENERAL RECORDER).

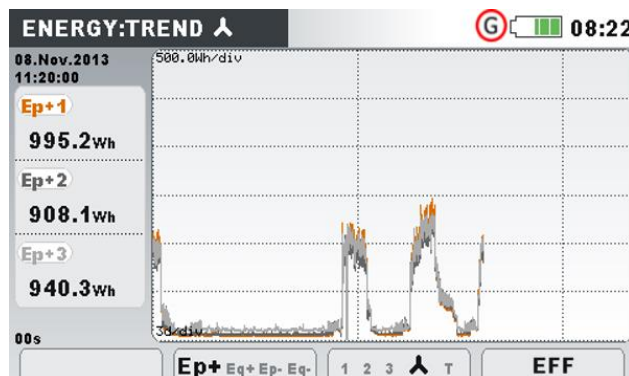

Figure 34: Energy trend screen

Table 19: Instrument screen symbols and abbreviations

Ep+	Consumed (+) phase (Ep ₁ ⁺ , Ep ₂ ⁺ , Ep ₃ ⁺) or total (Ep _{tot} ⁺) active energy
Ep-	Generated (-) phase (Ep ₁ ⁻ , Ep ₂ ⁻ , Ep ₃ ⁻) or total (Ep _{tot} ⁻) active energy
Eq+	Consumed (+) phase (Eq ₁ ⁺ , Eq ₂ ⁺ , Eq ₃ ⁺) or total (Eq _{tot} ⁺) fundamental reactive energy
Eq-	Generated (-) phase (Eq ₁ ⁻ , Eq ₂ ⁻ , Eq ₃ ⁻) or total (Eq _{tot} ⁻) fundamental reactive energy
Start	Recorder start time and date
Duration	Recorder elapsed time

Table 20: Keys in Energy (TREND) screens

F2	Ep+ Eq+ Ep- Eq-	Shows active consumed energy for time interval (IP) selected by cursor.
	Ep+ Eq+ Ep- Eq-	Shows reactive consumed energy for time interval (IP) selected by cursor.

	Ep+ Eq+ Ep- Eq-	Shows active generated energy for time interval (IP) selected by cursor.
	Ep+ Eq+ Ep- Eq-	Shows reactive generated energy for time interval (IP) selected by cursor.
F3	1 2 3 ^ T	Shows energy records for phase L1.
	1 2 3 ^ T	Shows energy records for phase L2.
	1 2 3 ^ T	Shows energy records for phase L3.
	1 2 3 ^ T	Shows all phases energy records.
	1 2 3 ^ T	Shows energy records for Totals.
F4	METER	Switches to METER view.
	TREND	Switches to TREND view.
	EFF	Switches to EFFICIENCY view.
ESC		Returns to the "MEASUREMENTS" submenu.

3.7.3 Efficiency

EFFICIENCY view is available only during active recording (see section 3.14 for instructions how to start GENERAL RECORDER).

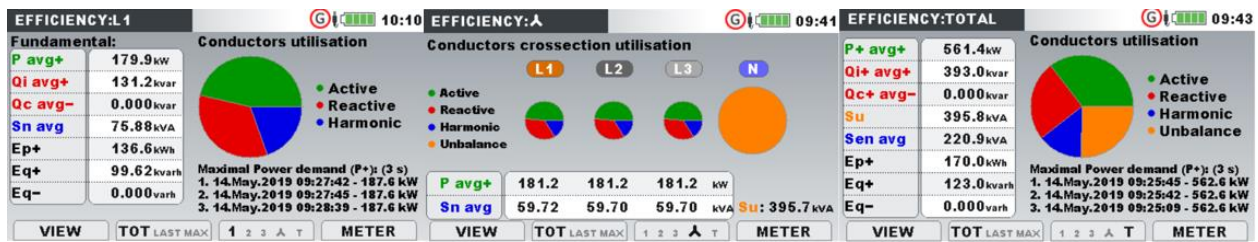
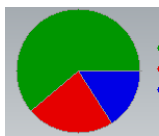

Figure 35: Energy efficiency screen

Table 21: Instrument screen symbols and abbreviations

P avg+	Consumed phase fundamental active power ($Pfund_1^+, Pfund_2^+, Pfund_3^+$)
P+ avg+	Positive sequence of total fundamental consumed active power (P_{tot}^+)
P avg-	Generated phase fundamental active power ($Pfund_1^-, Pfund_2^-, Pfund_3^-$)
P+ avg-	Positive sequence of total fundamental generated active power (P_{tot}^-) Shown active power is averaged over chosen time interval (key: F2) <ul style="list-style-type: none"> TOT – shows total average (for complete record) active power LAST – shows average active power in the last interval MAX - shows average active power in interval where Ep was maximal.
Q _i avg+	Consumed phase fundamental inductive reactive power ($Qfund_{ind1}^+, Qfund_{ind2}^+, Qfund_{ind3}^+$)
Q _i avg-	Generated phase fundamental inductive reactive power ($Qfund_{ind1}^-, Qfund_{ind2}^-, Qfund_{ind3}^-$)
Q _i avg+	Positive sequence of total inductive fundamental consumed reactive power (Q_{tot}^+)
Q _i avg-	Positive sequence of total inductive fundamental generated reactive power (Q_{tot}^-) Shown fundamental inductive reactive power is averaged over chosen time interval (key: F2) <ul style="list-style-type: none"> TOT – shows total average (for complete record) fundamental inductive reactive power

	<ul style="list-style-type: none"> • LAST – shows average fundamental inductive reactive power in the last interval • MAX – shows average fundamental inductive reactive power in interval where E_p was maximal.
Qc avg+ Qc+ avg+	Consumed phase fundamental capacitive reactive power ($Qfund_{cap1}^+$, $Qfund_{cap2}^+$, $Qfund_{cap3}^+$) Positive sequence of total capacitive fundamental consumed reactive power (Q_{tot}^{+})
Qc avg- Qc+ avg-	Generated phase fundamental capacitive reactive power ($Qfund_{cap1}^-$, $Qfund_{cap2}^-$, $Qfund_{cap3}^-$) Positive sequence of total capacitive fundamental generated reactive power (Q_{tot}^{+}) Shown fundamental capacitive reactive power is averaged over chosen time interval (key: F2) <ul style="list-style-type: none"> • TOT – shows total average (for complete record) fundamental capacitive reactive power • LAST – shows average fundamental capacitive reactive power in the last interval • MAX – shows average fundamental capacitive reactive power in interval where E_p was maximal.
Sn avg Sen avg	Phase nonfundamental apparent power (SN_1 , SN_2 , SN_3) Total effective nonfundamental apparent power (Sen). Shown nonfundamental apparent power is averaged over chosen time interval (key: F2) <ul style="list-style-type: none"> • TOT – shows total average (for complete record) of nonfundamental apparent power • LAST – shows average nonfundamental apparent power in the last interval • MAX – shows average nonfundamental apparent power in interval where E_p was maximal.
Su	Fundamental unbalanced power, according to the IEEE 1459-2010
Ep+ Ep-	Consumed phase (Ep_1^+ , Ep_2^+ , Ep_3^+) or total (Ep_{tot}^+) active energy Generated phase (Ep_1^- , Ep_2^- , Ep_3^-) or total (Ep_{tot}^-) active energy Shown active energy depends on chosen time interval (key: F2) <ul style="list-style-type: none"> • TOT – shows accumulated energy for complete record • LAST – shows accumulated energy in last interval • MAX – shows maximal accumulated energy in any interval
Eq+ Eq-	Consumed (+) phase (Eq_1^+ , Eq_2^+ , Eq_3^+) or total (Eq_{tot}^+) fundamental reactive energy Generated (-) phase (Eq_1^- , Eq_2^- , Eq_3^-) or total (Eq_{tot}^-) fundamental reactive energy Shown reactive energy depends on chosen time interval (key: F2) <ul style="list-style-type: none"> • TOT – shows accumulated energy for complete record • LAST – shows accumulated energy in last interval • MAX – shows accumulated reactive energy in interval where E_p was maximal.
Conductors utilisation	Shows conductor cross section utilisation for chosen time interval (TOT/LAST/MAX): <ul style="list-style-type: none"> • GREEN colour – represents part of conductor cross section (wire) used for active energy transfer (E_p) • RED colour – represents part of conductor cross section (wire) used for fundamental reactive energy transfer (Eq) • BLUE colour – represents part of conductor cross section (wire) used for nonfundamental (harmonic) apparent energy transfer (SN) • BROWN colour – represents unbalanced power (S_u) portion flowing in polyphase system in respect to phase power flow.
	
Date	End time of shown interval.
Max. Power Demand	Shows three intervals where measured fundamental active power was maximal. According to the selected channel (key: F3), and VIEW (key: F1) consumed phase and

total fundamental active power is shown ($Pfund_1^+$, $Pfund_2^+$, $Pfund_3^+$, P_{tot}^+) or generated phase and total fundamental active power is shown ($Pfund_1^-$, $Pfund_2^-$, $Pfund_3^-$, P_{tot}^-)

Table 22: Keys in Energy (TREND) screens

F1	VIEW	Switches between Consumed (+) and Generated (-) energy view.
F2	TOT LAST MAX	Shows parameters for complete record duration
	TOT LAST MAX	Shows parameters for last (complete) recorded interval
	TOT LAST MAX	Shows parameters for interval, where active energy was maximal
F3	1 2 3 ▲ T	Shows energy records for phase L1.
	1 2 3 ▲ T	Shows energy records for phase L2.
	1 2 3 ▲ T	Shows energy records for phase L3.
	1 2 3 ▲ T	Shows all phases energy records.
	1 2 3 ▲ T	Shows energy records for Totals.
	METER	Switches to METER view.
F4	TREND	Switches to TREND view.
	EFF	Switches to EFFICIENCY view.
ESC		Returns to the "MEASUREMENTS" submenu.

3.8 Harmonics / inter-harmonics

Harmonics presents voltage and current signals as a sum of sinusoids of power frequency and its integer multiples. Sinusoidal wave with frequency k-times higher than fundamental (k is an integer) is called harmonic wave and is denoted with amplitude and a phase shift (phase angle) to a fundamental frequency signal. If a signal decomposition with Fourier transformation results with presence of a frequency that is not integer multiple of fundamental, this frequency is called inter-harmonic frequency and component with such frequency is called inter-harmonic. See 5.1.8 for details.

3.8.1 Meter

By entering HARMONICS option from Measurements submenu, the tabular HARMONICS (METER) screen is shown (see figure below). In this screens' voltage and current harmonics or inter-harmonics and THD are shown.

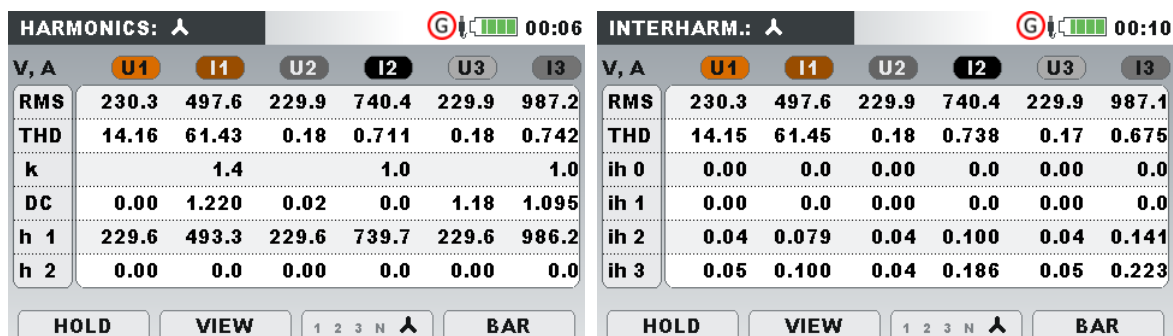

Figure 36: Harmonics and inter-harmonics (METER) screens

For phase harmonics presentation, there are also Power harmonics presented, for each phase separately:

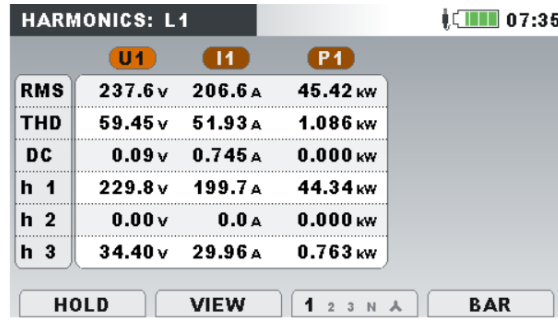







Figure 37: Phase harmonics presentation (U,I,P)



Description of symbols and abbreviations used in METER screens are shown in table below.

Table 23: Instrument screen symbols and abbreviations

RMS	RMS voltage / current value
THD	Total voltage / current harmonic distortion THD _U and THD _I in % of fundamental voltage / current harmonic or in RMS V, A.
k	k-factor (unit-less) indicates the amount of harmonics that load generate
DC	Voltage or current DC component in % of fundamental voltage / current harmonic or in RMS V, A.
h1 ... h50	n-th harmonic voltage U _{h_n} or current I _{h_n} component in % of fundamental voltage / current harmonic or in RMS V, A.
ih0 ... ih50	n-th inter-harmonic voltage U _{ih_n} or current I _{ih_n} component in % of fundamental voltage / current harmonic or in RMS V, A.

Table 24: Keys in Harmonics / inter-harmonics (METER) screens

	HOLD	Holds measurement on display. Hold clock time will be displayed in the right top corner.	
	RUN	Runs held measurement.	
	VIEW	Switches view between Harmonics and Inter-harmonics. Switches units between: <ul style="list-style-type: none"> • RMS (Volts, Amperes) • % of fundamental harmonic 	
		Keys in VIEW window:	
			Selects option.
			Confirms selected option.
		Exits selection window without change.	

		Selects between single phase, neutral, all-phases and line harmonics / inter-harmonics view.
F3	1 2 3 N ^	Shows harmonics / inter-harmonics components for phase L1.
	1 2 3 N ^	Shows harmonics / inter-harmonics components for phase L2.
	1 2 3 N ^	Shows harmonics / inter-harmonics components for phase L3.
	1 2 3 N ^	Shows harmonics / inter-harmonics components for neutral channel.
	1 2 3 N ^	Shows harmonics / inter-harmonics components for all phases on single screen.
	12 23 31 Δ	Shows harmonics / inter-harmonics components for phase L12.
	12 23 31 Δ	Shows harmonics / inter-harmonics components for phase L23.
	12 23 31 Δ	Shows harmonics / inter-harmonics components for phase L31.
	12 23 31 Δ	Shows harmonics / inter-harmonics components for phase-to-phase voltages.
	F4	METER
BAR		Switches to BAR view.
AVG		Switches to AVG (average) view (available only during recording).
TREND		Switches to TREND view (available only during recording).
		Shifts through harmonic / interharmonic components.
		Triggers Waveform snapshot.
		Returns to the "MEASUREMENTS" submenu.

3.8.2 Histogram (Bar)

Bar screen displays dual bar graphs. The upper bar graph shows instantaneous voltage harmonics and the lower bar graph shows instantaneous current harmonics.

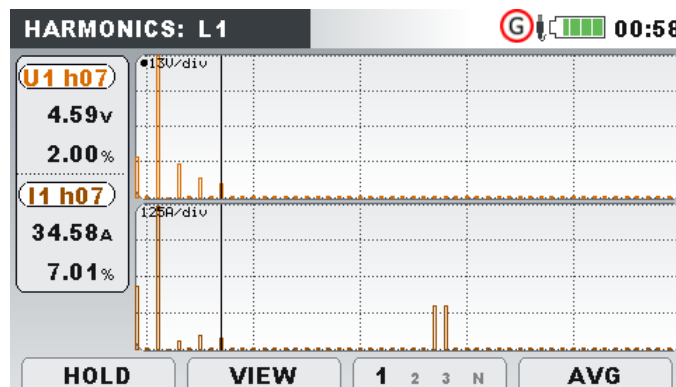



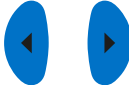





Figure 38: Harmonics histogram screen

Description of symbols and abbreviations used in BAR screens are shown in table below.

Table 25: Instrument screen symbols and abbreviations

Ux h01 ... h50	Instantaneous voltage harmonic / inter-harmonic component in V_{RMS} and in % of fundamental voltage
Ix h01 ... h50	Instantaneous current harmonic / inter-harmonic component in A_{RMS} and in % of fundamental current
Ux DC	Instantaneous DC voltage in V and in % of fundamental voltage
Ix DC	Instantaneous DC current in A and in % of fundamental current
Ux THD	Instantaneous total voltage harmonic distortion THD_U in V and in % of fundamental voltage
Ix THD	Instantaneous total current harmonic distortion THD_I in A_{RMS} and in % of fundamental current

Table 26: Keys in Harmonics / inter-harmonics (BAR) screens

	HOLD	Holds measurement on display.
	RUN	Runs held measurement.
Switches view between harmonics and inter-harmonics.		
Keys in VIEW window:		
	VIEW	 Selects option.
		 Confirms selected option.
		 Exits selection window without change.
		Selects between single phases and neutral channel harmonics / inter-harmonics bars.
	1 2 3 N	Shows harmonics / inter-harmonics components for phase L1.
	1 2 3 N	Shows harmonics / inter-harmonics components for phase L2.
	1 2 3 N	Shows harmonics / inter-harmonics components for phase L3.
	1 2 3 N	Shows harmonics / inter-harmonics components for neutral channel.
	12 23 31	Shows harmonics / inter-harmonics components for phase L12.
	12 23 31	Shows harmonics / inter-harmonics components for phases L23.
	12 23 31	Shows harmonics / inter-harmonics components for phases L31.
	METER	Switches to METER view.
	BAR	Switches to BAR view.
	AVG	Switches to AVG (average) view (available only during recording).
	TREND	Switches to TREND view (available only during recording).
	Scales displayed histogram by amplitude.	
	Scrolls cursor to select single harmonic / inter-harmonic bar.	



Toggles cursor between voltage and current histogram.



Triggers Waveform snapshot.



Returns to the "MEASUREMENTS" submenu.

3.8.3 Harmonics Average Histogram (Avg Bar)

During active GENERAL RECORDER, Harmonics average histogram AVG view is available (see section 3.14 for instructions how to start GENERAL RECORDER). In this view average voltage and current harmonic values are shown (averaged from beginning of the recording to the current moment). Harmonics average histogram screen displays dual bar graphs. The upper bar graph shows average voltage harmonics and the lower bar graph shows average current harmonics.

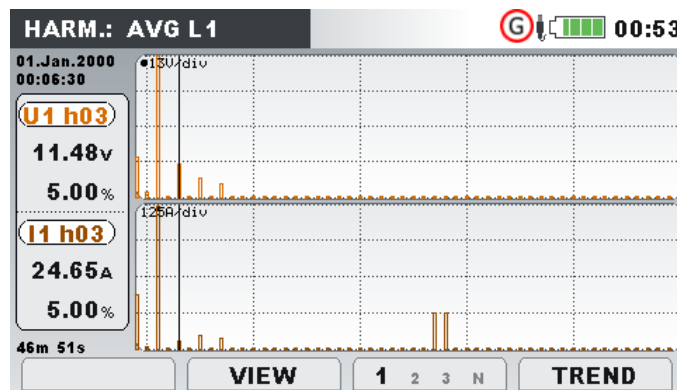

Figure 39: Harmonics average histogram screen

Description of symbols and abbreviations used in AVG screens are shown in table below.

Table 27: Instrument screen symbols and abbreviations

Ux h01 ... h50	Average voltage harmonic / inter-harmonic component in V_{RMS} and in % of fundamental voltage (from beginning of the recording)
Ix h01 ... h50	Average current harmonic / inter-harmonic component in A_{RMS} and in % of fundamental current
Ux DC	Average DC voltage in V and in % of fundamental voltage
Ix DC	Average DC current in A and in % of fundamental current
Ux THD	Average total voltage harmonic distortion THD_U in V and in % of fundamental voltage
Ix THD	Average total current harmonic distortion THD_I in A_{RMS} and in % of fundamental current

Table 28: Keys in Harmonics / inter-harmonics (AVG) screens

Switches view between harmonics and inter-harmonics.



VIEW

Keys in VIEW window:

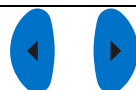

Selects option.

		Confirms selected option.
		Exits selection window without change.
		Selects between single phases and neutral channel harmonics / inter-harmonics bars.
	1 2 3 N	Shows harmonics / inter-harmonics components for phase L1.
	1 2 3	Shows harmonics / inter-harmonics components for phase L2.
	1 2 3 N	Shows harmonics / inter-harmonics components for phase L3.
	1 2 3 N	Shows harmonics / inter-harmonics components for neutral channel.
	12 23 31	Shows harmonics / inter-harmonics components for phase L12.
	12 23 31	Shows harmonics / inter-harmonics components for phases L23.
	12 23 31	Shows harmonics / inter-harmonics components for phases L31.
	METER	Switches to METER view.
	BAR	Switches to BAR view.
	AVG	Switches to AVG (average) view (available only during recording).
	TREND	Switches to TREND view (available only during recording).
		Scales displayed histogram by amplitude.
		Scrolls cursor to select single harmonic / inter-harmonic bar.
		Toggles cursor between voltage and current histogram.
		Triggers Waveform snapshot.
		Returns to the "MEASUREMENTS" submenu.

3.8.4 Trend

During active GENERAL RECORDER, TREND view is available (see section 3.14 for instructions how to start GENERAL RECORDER). Voltage and current harmonic / inter-harmonic components can be observed by cycling function key F4 (METER-BAR-AVG-TREND).

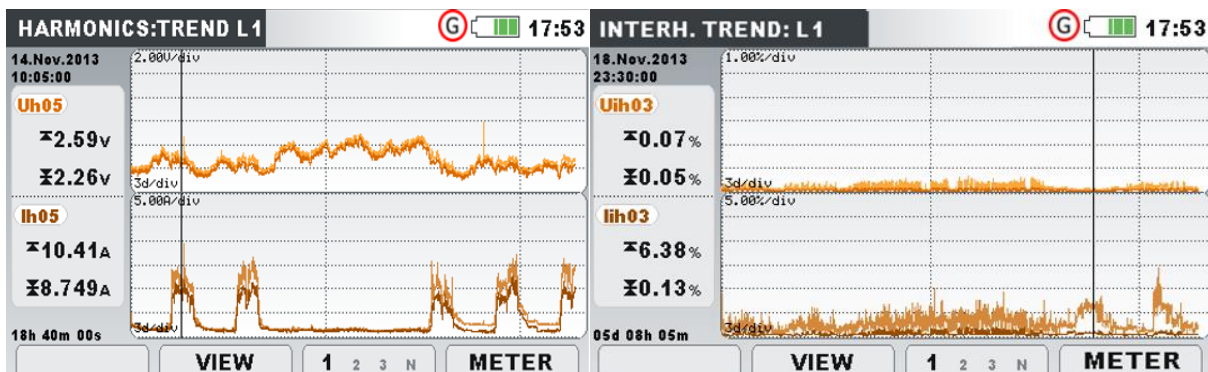

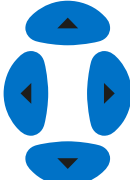





Figure 40: Harmonics and inter-harmonics trend screen

Table 29: Instrument screen symbols and abbreviations

ThdU	Interval maximal (☒) and average (☒) value of total voltage harmonic distortion THD _U for selected phase
ThdI	Interval maximal (☒) and average (☒) value of total current harmonic distortion THD _I for selected phase
Udc	Interval maximal (☒) and average (☒) value of DC voltage component for selected phase
Idc	Interval maximal (☒) and average (☒) value of selected DC current component for selected phase
Uh01...Uh50 Uih01...Uih50	Interval maximal (☒) and average (☒) value for selected n-th voltage harmonic / inter-harmonic component for selected phase
Ih01...Ih50 Iih01...Iih50	Interval maximal (☒) and average (☒) value of selected n-th current harmonic / inter-harmonic component for selected phase

Table 30: Keys in Harmonics / inter-harmonics (TREND) screens

	Switches between harmonics or inter-harmonics view. Switches measurement units between RMS V,A or % of fundamental harmonic. Selects harmonic number for observing.
	VIEW
	Keys in VIEW window:
	 Selects option.
	 Confirms selected option.
	 Exits selection window without change.
	<p>Selects between single phases and neutral channel harmonics / inter-harmonics trends.</p> <p>1 2 3 N Shows selected harmonics / inter-harmonics components for phase L1.</p> <p>1 2 3 N Shows selected harmonics / inter-harmonics components for phase L2.</p> <p>1 2 3 N Shows selected harmonics / inter-harmonics components for phase L3.</p> <p>1 2 3 N Shows selected harmonics / inter-harmonics components for neutral channel.</p> <p>12 23 31 Shows selected harmonics / inter--harmonics components for phase to phase voltage L12.</p> <p>12 23 31 Shows selected harmonics / inter-harmonics components for phase to phase voltage L23.</p>

12 23 31	Shows selected harmonics / inter-harmonics components for phase to phase voltage L31.
METER	Switches to METER view.
BAR	Switches to BAR view.
F4	AVG Switches to AVG (average) view (available only during recording).
	TREND Switches to TREND view (available only during recording).
	Moves cursor and select time interval (IP) for observation.
ESC	Returns to the "MEASUREMENTS" submenu.

3.9 Flickers

Flickers measure the human perception of the effect of amplitude modulation on the mains voltage powering a light bulb. In Flickers menu instrument shows measured flicker parameters. Results can be seen in a tabular (METER) or a graphical form (TREND) - which is active only while GENERAL RECORDER is active. See section 3.14 for instructions how to start recording. In order to understand meanings of particular parameter see section 5.1.9.

3.9.1 Meter

By entering FLICKERS option from MEASUREMENTS submenu, the FLICKERS tabular screen is shown (see figure below).

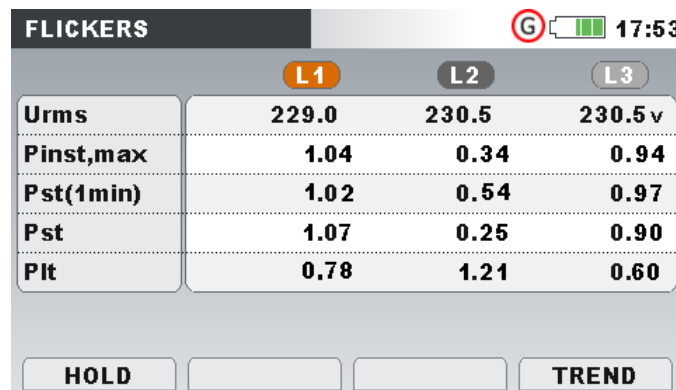

Figure 41: Flickers table screen





Description of symbols and abbreviations used in METER screen is shown in table below. Note that Flickers measurement intervals are synchronised to real time clock, and therefore refreshed on minute, 10 minutes and 2 hours intervals.

Table 31: Instrument screen symbols and abbreviations

Urms	True effective value $U_1, U_2, U_3, U_{12}, U_{23}, U_{31}$
Pinst,max	Maximal instantaneous flicker for each phase refreshed each 10 seconds
Pst(1min)	Short term (1 min) flicker P_{st1min} for each phase measured in last minute
Pst	Short term (10 min) flicker P_{st} for each phase measured in last 10 minutes

Plt Long term flicker (2h) P_{st} for each phase measured in last 2 hours

Table 32: Keys in Flickers (METER) screen

	HOLD	Holds measurement on display. Hold clock time will be displayed in the right top corner.
	RUN	Runs held measurement.
	METER	Switches to METER view.
	TREND	Switches to TREND view (available only during recording).
		Triggers Waveform snapshot.
		Returns to the "MEASUREMENTS" submenu.

3.9.2 Trend

During active recording TREND view is available (see section 3.14 for instructions how to start recording). Flicker parameters can be observed by cycling function key F4 (METER -TREND). Note that Flicker meter recording intervals are determinate by standard IEC 61000-4-15. Flicker meter therefore works independently from chosen recording interval in GENERAL RECORDER.

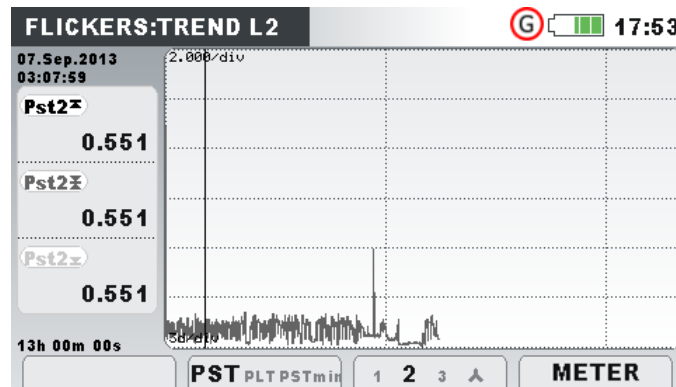











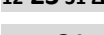
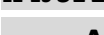









Figure 42: Flickers trend screen

Table 33: Instrument screen symbols and abbreviations

Pst1m1, Pst1m2, Pst1m3, Pst1m12, Pst1m23, Pst1m31	Maximal ($\mathbf{\bar{P}}$), average ($\mathbf{\bar{P}}$) and minimal ($\mathbf{\underline{P}}$) value of 1-minute short term flicker $P_{st(1min)}$ for phase voltages U_1, U_2, U_3 or line voltages U_{12}, U_{23}, U_{31}
Pst1, Pst2, Pst3, Pst12, Pst23, Pst31	Maximal ($\mathbf{\bar{P}}$), average ($\mathbf{\bar{P}}$) and minimal ($\mathbf{\underline{P}}$) value of 10-minutes short term flicker P_{st} for phase voltages U_1, U_2, U_3 or line voltages U_{12}, U_{23}, U_{31}
Plt1, Plt2, Plt3, Plt12, Plt23, Plt31	Maximal ($\mathbf{\bar{P}}$), average ($\mathbf{\bar{P}}$) and minimal ($\mathbf{\underline{P}}$) value of 2-hours long term flicker P_{lt} in phase voltages U_1, U_2, U_3 or line voltages U_{12}, U_{23}, U_{31}

Table 34: Keys in Flickers (TREND) screens

		Selects between the following options:
		Shows 10 min short term flicker P_{st} .
		Shows long term flicker P_{lt} .
		Shows 1 min short term flicker P_{st1min} .
		Selects between trending various parameters:
		Shows selected flicker trends for phase L1.
		Shows selected flicker trends for phase L2.
		Shows selected flicker trends for phase L3.
		Shows selected flicker trends for all phases (average only).
		Shows selected flicker trends for phases L12.
		Shows selected flicker trends for phases L23.
		Shows selected flicker trends for phases L31.
		Shows selected flicker trends for all phases (average only).
		Switches to METER view.
		Switches to TREND view (available only during recording).
		Moves cursor and selects time interval (IP) for observation.
		Returns to the "MEASUREMENTS" submenu.

3.10 Phase Diagram

Phase diagram graphically represent fundamental voltages, currents and phase angles of the network. This view is strongly recommended for checking instrument connection before measurement. Note that most measurement issues arise from wrongly connected instrument (see 4.1 for recommended measuring practice). On phase diagram screens instrument shows:

- Graphical presentation of voltage and current phase vectors of the measured system,
- Unbalance of the measured system.

3.10.1 Phase diagram

By entering PHASE DIAGRAM option from MEASUREMENTS submenu, the following screen is shown (see figure below).

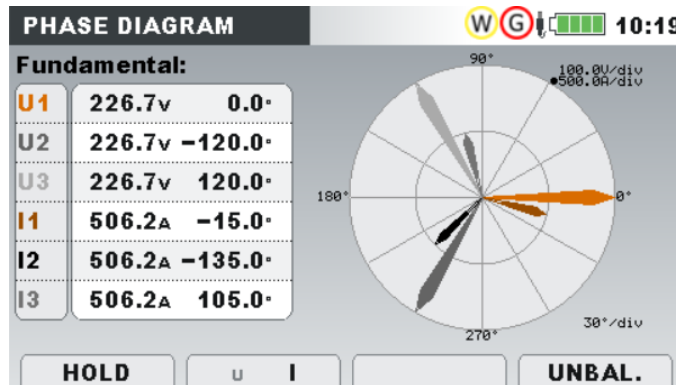

Figure 43: Phase diagram screen

Table 35: Instrument screen symbols and abbreviations

U1, U2, U3	Fundamental voltages U_{fund_1} , U_{fund_2} , U_{fund_3} with relative phase angle to U_{fund_1}
U12, U23, U31	Fundamental voltages $U_{fund_{12}}$, $U_{fund_{23}}$, $U_{fund_{31}}$ with relative phase angle to $U_{fund_{12}}$
I1, I2, I3	Fundamental currents I_{fund_1} , I_{fund_2} , I_{fund_3} with relative phase angle to U_{fund_1} or $U_{fund_{12}}$

Table 36: Keys in Phase diagram screen

F1	HOLD	Holds measurement on display. Hold clock time will be displayed in the right top corner.
	RUN	Runs held measurement.
F2	U I	Selects voltage for scaling (with cursors).
	I U	Selects current for scaling (with cursors).
F4	METER	Switches to PHASE DIAGRAM view.
	UNBAL.	Switches to UNBALANCE DIAGRAM view.
	TREND	Switches to TREND view (available only during recording).
		Scales voltage or current phasors.
		Triggers Waveform snapshot.
ESC		Returns to the "MEASUREMENTS" submenu.

3.10.2 Unbalance diagram

Unbalance diagram represents current and voltage unbalance of the measuring system. Unbalance arises when RMS values or phase angles between consecutive phases are not equal. Diagram is shown on figure below.

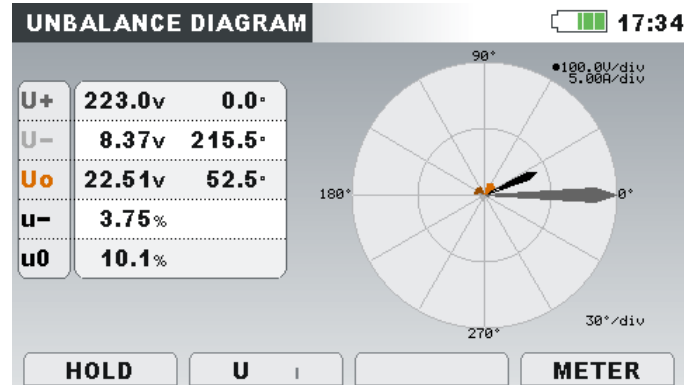







Figure 44: Unbalance diagram screen

Table 37: Instrument screen symbols and abbreviations

U0	Zero sequence voltage component U^0
I0	Zero sequence current component I^0
U+	Positive sequence voltage component U^+
I+	Positive sequence current component I^+
U-	Negative sequence voltage component U^-
I-	Negative sequence current component I^-
u-	Negative sequence voltage ratio u^-
i-	Negative sequence current ratio i^-
u0	Zero sequence voltage ratio u^0
i0	Zero sequence current ratio i^0

Table 38: Keys in Unbalance diagram screens

	HOLD	Holds measurement on display. Hold clock time will be displayed in the right top corner.
	RUN	Runs held measurement.
	U I	Shows voltage unbalance measurement and selects voltage for scaling (with cursors)
	I U	Shows current unbalance measurement and selects current for scaling (with cursors)
	METER	Switches to PHASE DIAGRAM view.
	UNBAL.	Switches to UNBALANCE DIAGRAM view.
	TREND	Switches to TREND view (available only during recording).
		Scales voltage or current phasors.
		Triggers Waveform snapshot.
		Returns to the "MEASUREMENTS" submenu.

3.10.3 Unbalance trend

During active recording UNBALANCE TREND view is available (see section 3.14 for instructions how to start GENERAL RECORDER).

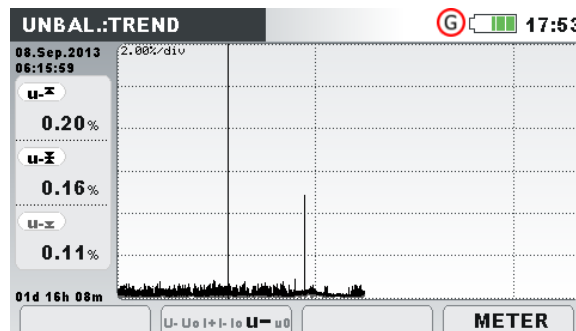























Figure 45: Symmetry trend screen

Table 39: Instrument screen symbols and abbreviations

u-	Maximal () , average () and minimal () value of negative sequence voltage ratio u-
u0	Maximal () , average () and minimal () value of zero sequence voltage ratio u ⁰
i-	Maximal () , average () and minimal () value of negative sequence current ratio i-
i0	Maximal () , average () and minimal () value of zero sequence current ratio i ⁰
U+	Maximal () , average () and minimal () value of positive sequence voltage U ⁺
U-	Maximal () , average () and minimal () value of negative sequence voltage U ⁻

U0	Maximal (⚡), average (⚡) and minimal (⚡) value of zero sequence voltage U^0
I+	Maximal (⚡), average (⚡) and minimal (⚡) value of positive sequence current I^+
I-	Maximal (⚡), average (⚡) and minimal (⚡) value of negative sequence current I^-
I0	Maximal (⚡), average (⚡) and minimal (⚡) value of zero sequence current I^0

Table 40: Keys in Unbalance trend screens

	U+ U- U0 I+ I- I0 u+ u0 i+ i0	Shows selected voltage and current unbalance measurement (U^+ , U^- , U^0 , I^+ , I^- , I^0 , u^+ , u^0 , i^+ , i^0).
	METER	Switches to PHASE DIAGRAM view.
	UNBAL.	Switches to UNBALANCE DIAGRAM view.
	TREND	Switches to TREND view (available only during recording).
		Moves cursor and selects time interval (IP) for observation.
	ESC	Returns to the "MEASUREMENTS" submenu.

3.11 Temperature

Power Master XT instrument is capable of measuring and recording temperature with Temperature probe A 1354. Temperature is expressed in both units, Celsius and Fahrenheit degrees. See following sections for instructions how to start recording. In order to learn how to set up neutral clamp input with the temperature sensor, see section 4.2.4.

3.11.1 Meter

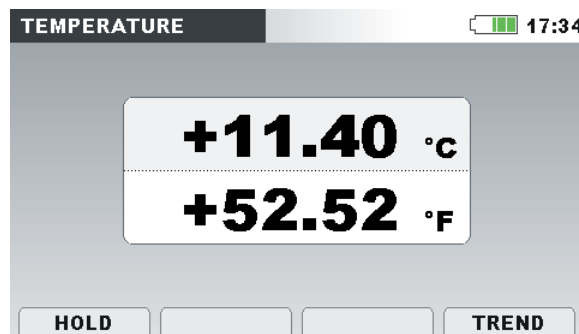





Figure 46: Temperature meter screen

Table 41: Instrument screen symbols and abbreviations

°C	Current temperature in Celsius degrees
°F	Current temperature in Fahrenheit degrees

Table 42: Keys in Temperature meter screen

	HOLD	Holds measurement on display. Hold clock time will be displayed in the right top corner.
	RUN	Runs held measurement.
	METER	Switches to METER view.
	TREND	Switches to TREND view (available only during recording).
		Triggers Waveform snapshot.
		Returns to the "MEASUREMENTS" submenu.

3.11.2 Trend

Temperature measurement TREND can be viewed during the recording in progress. Records containing temperature measurement can be viewed from Memory list and by using PC software PowerView v3.0.

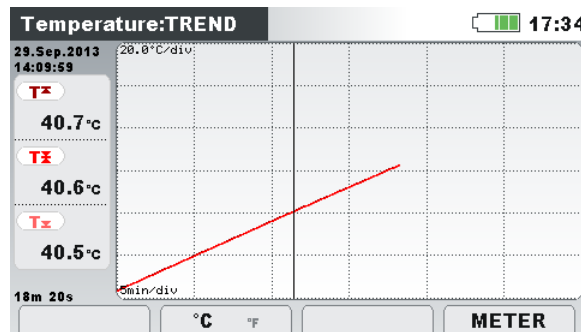





Figure 47: Temperature trend screen

Table 43: Instrument screen symbols and abbreviations

T:	Maximal (⌘), average (⌘) and minimal (⌘) temperature value for last recorded time interval (IP)
----	---

Table 44: Keys in Temperature trend screens

	°C °F	Shows temperature in Celsius degrees.
	°C °F	Shows temperature in Fahrenheit degrees.
	METER	Switches to METER view.
	TREND	Switches to TREND view (available only during recording).
		Returns to the "MEASUREMENTS" submenu.

3.12 Under deviation and over deviation

Under deviation and over deviation parameters are useful when it is important to avoid, for example, having sustained under voltages being cancelled in data by sustained over voltages. Results can be seen in a tabular (METER) or a graphical form (TREND) view - which is active only while GENERAL RECORDER is active. See section 3.14 for instructions how to start recording. In order to understand meanings of particular parameter see section 5.1.12.

3.12.1 Meter

By entering DEVIATION option from MEASUREMENTS submenu, the UNDER/OVER DEVIATION tabular screen is shown (see figure below).

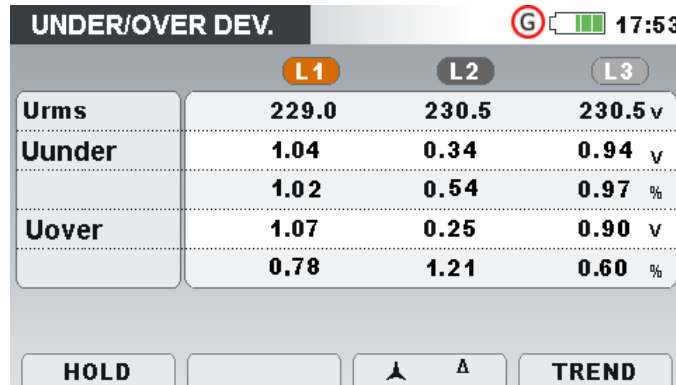

Figure 48: Under deviation and over deviation table screen

Description of symbols and abbreviations used in METER screen is shown in table below.

Table 45: Instrument screen symbols and abbreviations

Urms	True effective value $U_1, U_2, U_3, U_{12}, U_{23}, U_{31}$
Uunder	Instantaneous under deviation voltage U_{Under} expressed in voltage and % of nominal voltage
Uover	Instantaneous over deviation voltage U_{Over} expressed in voltage and % of nominal voltage

Table 46: Keys in Under deviation and over deviation (METER) screen

F1	HOLD	Holds measurement on display. Hold clock time will be displayed in the right top corner.
	RUN	Runs held measurement.
F3		Selects between trending various parameters
		Shows under/over deviations measurements for all phase voltages Shows under/over deviations measurements for all phase to phase voltages
F4	METER	Switches to METER view.
	TREND	Switches to TREND view (available only during recording).
		Triggers Waveform snapshot.
ESC		Returns to the “MEASUREMENTS” submenu.

3.12.2 Trend

During active recording TREND view is available (see section 3.14 for instructions how to start recording). Under deviation and over deviation parameters can be observed by cycling function key F4 (METER -TREND).

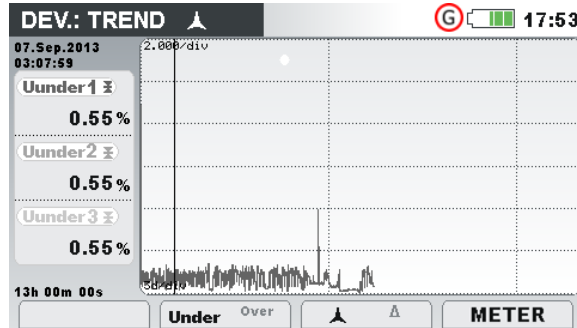

Figure 49: Under-deviation and over-deviation TREND screen

Table 47: Instrument screen symbols and abbreviations

Uunder1	
Uunder2	
Uunder3	Interval average (⚡) value of corresponding under deviation voltage U_{1Under}
Uunder12	U_{2Under} , U_{3Under} , $U_{12Under}$, $U_{23Under}$, $U_{31Under}$, expressed in % of nominal voltage.
Uunder22	
Uunder31	
Uover1	
Uover2	
Uover3	Interval average (⚡) value of corresponding over deviation voltage U_{1Over} , U_{2Over}
Uover12	U_{3Over} , U_{12Over} , U_{23Over} , U_{31Over} , expressed in % of nominal voltage.
Uover23	
Uover31	

Table 48: Keys in Under deviation and Over deviation (TREND) screens

F2	Under Over	Selects between the following options:
	Under Over	Shows under deviation trends
F3	⤴ ⤵	Selects between trending various parameters:
	⤴ ⤵	Shows trends for all phase under/over deviations
F4	METER	Shows trends for all lines under/over deviations
	TREND	Switches to METER view.
ESC	⏪ ⏩	Switches to TREND view (available only during recording).
	ESC	Moves cursor and selects time interval (IP) for observation.
	ESC	Returns to the "MEASUREMENTS" submenu.

3.13 Signalling

Mains signalling voltage, called “ripple control signal” in certain applications, is a burst of signals, often applied at a non-harmonic frequency, that remotely control industrial equipment, revenue meters, and other devices. Before observing signalling measurements, user should set-up signalling frequencies in signalling setup menu (see section 3.21.4).

Results can be seen in a tabular (METER) or a graphical form (TREND) - which is active only while GENERAL RECORDER is active. See section 3.14 for instructions how to start recording. In order to understand meanings of particular parameter see section 5.1.9.

3.13.1 Meter

By entering SIGNALLING option from MEASUREMENTS submenu, the SIGNALLING tabular screen is shown (see figure below).

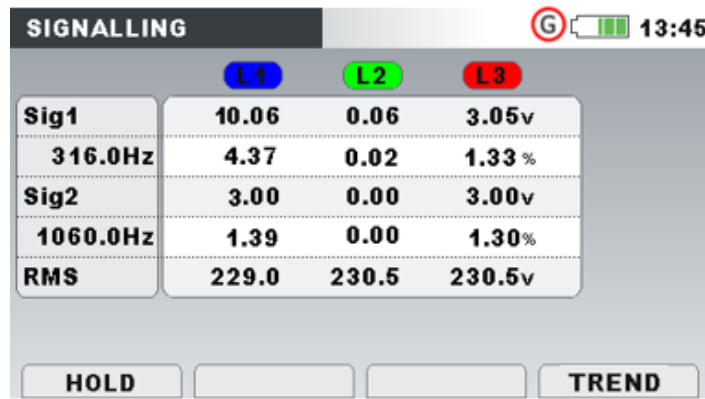

Figure 50: Signalling meter screen

Description of symbols and abbreviations used in METER screen is shown in table below.

Table 49: Instrument screen symbols and abbreviations

Sig1 316.0 Hz	True effective value signal voltage ($U_{Sig1}, U_{Sig2}, U_{Sig3}, U_{Sig12}, U_{Sig23}, U_{Sig31}$) for a user-specified carrier frequency (316.0 Hz in shown example) expressed in Volts or percent of fundamental voltage
Sig2 1060.0 Hz	True effective value signal voltage ($U_{Sig1}, U_{Sig2}, U_{Sig3}, U_{Sig12}, U_{Sig23}, U_{Sig31}$) for a user-specified carrier frequency (1060.0 Hz in shown example) expressed in Volts or percent of fundamental voltage
RMS	True effective value of phase or phase to phase voltage $U_{Rms} (U_1, U_2, U_3, U_{12}, U_{23}, U_{31})$

Table 50: Keys in Signalling (METER) screen

F1	HOLD	Holds measurement on display. Hold clock time will be displayed in the right top corner.
	RUN	Runs held measurement.
F4	METER	Switches to METER view.
	TREND	Switches to TREND view (available only during recording).
	TABLE	Switches to TABLE view (available only during recording).



Triggers Waveform snapshot.



Returns to the "MEASUREMENTS" submenu.

3.13.2 Trend

During active recording TREND view is available (see section 3.14 for instructions how to start recording). Signalling parameters can be observed by cycling function key F4 (METER -TREND).

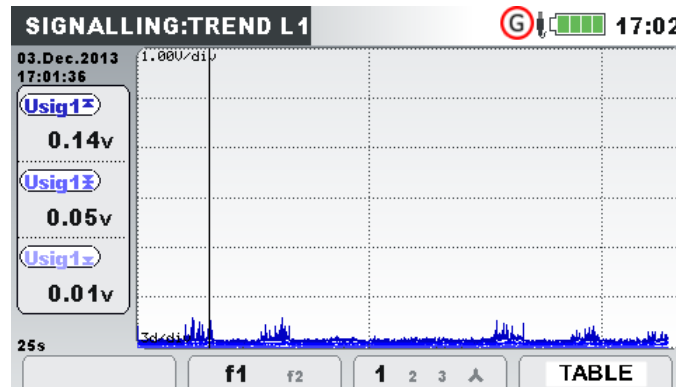

Figure 51: Signalling trend screen

Table 51: Instrument screen symbols and abbreviations

Usig1, Usig2, Usig3, Usig12, Usig23, Usig31	Maximal (▲), average (⚡) and minimal (▼) value of (U_{Sig1} , U_{Sig2} , U_{Sig3} , U_{Sig12} , U_{Sig23} , U_{Sig31}) signal voltage for a user-specified Sig1/Sig2 frequency (Sig1 = 316.0 Hz / Sig2 = 1060.0 Hz in shown example).
14.Nov.2013 13:50:00	Timestamp of interval (IP) selected by cursor.
22h 25m 00s	Current GENERAL RECORDER time (Days hours:min:sec)

Table 52: Keys in Signalling (TREND) screen

F2	f1 f2	Selects between the following options: Shows signal voltage for a user-specified signalling frequency (Sig1).
	f1 f2	Shows signal voltage for a user-specified signalling frequency (Sig2).
F3	1 2 3 ▲	Selects between trending various parameters: Shows signalling for phase 1
	1 2 3 ▲	Shows signalling for phase 2
	1 2 3 ▲	Shows signalling for phase 3
	1 2 3 ▲	Shows signalling for all phases (average only)
	12 23 31 ▲	Shows signalling for phase to phase voltage L12.
	12 23 31 ▲	Shows signalling for phase to phase voltage L23.
	12 23 31 ▲	Shows signalling for phase to phase voltage L31.
12 23 31 ▲	Shows signalling for all phase to phase voltages (average only).	
METER		Switches to METER view.

TREND Switches to TREND view (available only during recording).

TABLE Switches to TABLE view (available only during recording).

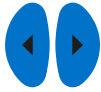

Moves cursor and select time interval (IP) for observation.



Returns to the "MEASUREMENTS" submenu.

3.13.3 Table

During active recording TABLE view is available (see section 3.14 for instructions how to start recording), by cycling function key F4 (METER –TREND - TABLE). Signalling events can be here observed as required by standard IEC 61000-4-30. For each signalling event instrument capture waveform which can be observed in PowerView.

No	L	F	Sig	START	MAX
1	1	0	f1	08.Jan.2016 10:03:09.404	13.5V
2	1	1	f1	08.Jan.2016 10:03:29.405	13.5V
3	2	1	f1	08.Jan.2016 10:03:49.412	13.5V
4	1	0	f1	08.Jan.2016 10:04:09.404	13.5V
5	1	0	f2	08.Jan.2016 10:04:29.405	12.8V
6	1	0	f2	08.Jan.2016 10:04:40.205	12.9V

Level=5.0%, Duration=10s, f1=316Hz, f2=1060Hz

METER

Figure 52: Signalling table screen

Table 53: Instrument screen symbols and abbreviations

No	Signalling event number
L	Phases on which signalling event occurred
F	Flag indication <ul style="list-style-type: none"> • 0 – none of intervals are flagged • 1 – at least one of intervals inside recorded signalling is flagged
Sig	Frequency on which signalling occurred, defined as "Sign. 1" frequency (f1) and "Sign. 2" frequency (f2) in SIGNALLING SETUP menu. See 3.21.4 for details.
START	Time when observed Signalling voltage crosses threshold boundary.
MAX	Maximal voltage level recorder captured during signalling events
Level	Threshold level in % of nominal voltage Un, defined in SIGNALLING SETUP menu. See 3.21.4 for details.
Duration	Duration of captured waveform, defined in SIGNALLING SETUP menu. See 3.21.4 for details.
f1	1 st observed signalling frequency.
f2	2 nd observed signalling frequency.

Table 54: Keys in Signalling (TABLE) screen

	METER	Switches to METER view.
F4	TREND	Switches to TREND view (available only during recording).
	TABLE	Switches to TABLE view (available only during recording).
		Moves cursor through signalling table.
ESC		Returns to the "MEASUREMENTS" submenu.

3.14 General Recorder



Power Master XT has ability to record measured data in the background. By entering GENERAL RECORDER option from RECORDERS submenu, recorder parameters can be customized in order to meet criteria about interval, start time and duration for the recording campaign. General recorder setup screen is shown below:









Figure 53: General recorder setup screen

Description of General recorder settings is given in the following table:

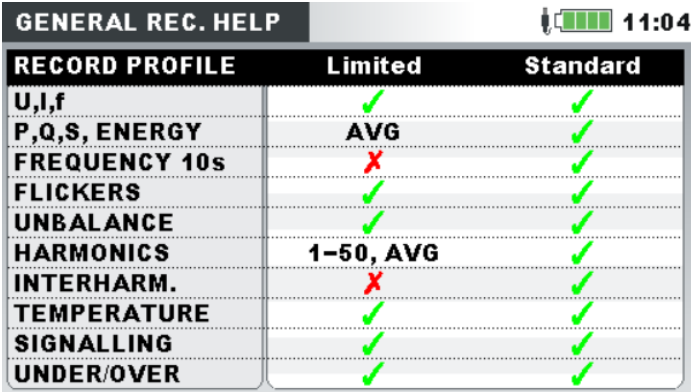







Table 55: General recorder settings description and screen symbols

	General recorder is active, waiting for start condition to be met. After start conditions are met (defined start time), instrument will capture waveform snapshot and start (activate) General recorder.
	<p>General recorder is active, recording in progress</p> <p>Note: Recorder will run until one of the following end conditions is met:</p> <ul style="list-style-type: none"> • STOP key was pressed by user • Given Duration criteria was met • Maximal record length was reached • SD CARD is full <p>Note: If recorder start time is not explicitly given, recorder start depends on Real Time clock multiple of interval. For example: recorder is activated at 12:12 with 5-minute interval. Recorder will actually start at 12:15.</p> <p>Note: If during record session instrument batteries are drained, due</p>

	to long interruption for example, instrument will shut down automatically. After power restoration, it will automatically start new recording session.
	Capturing of predefined Alarms under progress
	Capturing of predefined Events under progress
	Capturing of Inrush under progress
	Capturing of RVC under progress
	Capturing of Signalling under progress
	Capturing of Transient under progress
Profile	<p>Select recording profile:</p> <ul style="list-style-type: none"> • Standard profile. Include all measurement in record. Suitable for most PQ measurement • Limited profile. Include limited set of measurements (most important). Suitable for long records with short interval (1-week record with 1 second interval). See section 4.4 for details.
Interval	<p>Define the measured interval. Available settings are from 1 second to 120 minutes.</p> <p>Available intervals: 1 sec, 3 sec, 5 sec, 10 sec, 1 min, 2 min, 5 min, 10 min, 15 min, 30 min, 60 min, 120 min</p>
Start time	<p>Define start time of recording:</p> <ul style="list-style-type: none"> • Manual, pressing function key F1 • At the given time and date.
Duration	<p>Define recording duration. General recorder will record measurement for given time duration:</p> <ul style="list-style-type: none"> • Manual, • 5, 10, 20, 30 minutes • 1, 6 or 12 hours, or • 1, 2, 3, 7, 15, 30, 60 days. <p>Note: number of available duration intervals is related to the recorder period.</p>
Included	<p>Define network events, which are captured and registered during recorder session – ON/OFF selection:</p> 
Recommended/maximal record duration:	Show recommended and maximal Duration parameter for given recording Interval.

Available memory Show SD card free space

Table 56: Keys in General recorder setup screen

F1	START STOP	Starts the recorder. Stops the recorder.																																				
F2	HELP	<p>Show help screen where it's explained which measurements will be recorded with Limited and Standard profile.</p>  <table border="1" data-bbox="564 510 1257 900"> <thead> <tr> <th colspan="3">GENERAL REC. HELP</th> </tr> <tr> <th>RECORD PROFILE</th> <th>Limited</th> <th>Standard</th> </tr> </thead> <tbody> <tr> <td>U,I,f</td> <td>✓</td> <td>✓</td> </tr> <tr> <td>P,Q,S, ENERGY</td> <td>AVG</td> <td>✓</td> </tr> <tr> <td>FREQUENCY 10s</td> <td>X</td> <td>✓</td> </tr> <tr> <td>FLICKERS</td> <td>✓</td> <td>✓</td> </tr> <tr> <td>UNBALANCE</td> <td>✓</td> <td>✓</td> </tr> <tr> <td>HARMONICS</td> <td>1-50, AVG</td> <td>✓</td> </tr> <tr> <td>INTERHARM.</td> <td>X</td> <td>✓</td> </tr> <tr> <td>TEMPERATURE</td> <td>✓</td> <td>✓</td> </tr> <tr> <td>SIGNALLING</td> <td>✓</td> <td>✓</td> </tr> <tr> <td>UNDER/OVER</td> <td>✓</td> <td>✓</td> </tr> </tbody> </table> <p>See section 4.4 for details.</p>	GENERAL REC. HELP			RECORD PROFILE	Limited	Standard	U,I,f	✓	✓	P,Q,S, ENERGY	AVG	✓	FREQUENCY 10s	X	✓	FLICKERS	✓	✓	UNBALANCE	✓	✓	HARMONICS	1-50, AVG	✓	INTERHARM.	X	✓	TEMPERATURE	✓	✓	SIGNALLING	✓	✓	UNDER/OVER	✓	✓
GENERAL REC. HELP																																						
RECORD PROFILE	Limited	Standard																																				
U,I,f	✓	✓																																				
P,Q,S, ENERGY	AVG	✓																																				
FREQUENCY 10s	X	✓																																				
FLICKERS	✓	✓																																				
UNBALANCE	✓	✓																																				
HARMONICS	1-50, AVG	✓																																				
INTERHARM.	X	✓																																				
TEMPERATURE	✓	✓																																				
SIGNALLING	✓	✓																																				
UNDER/OVER	✓	✓																																				
F3	CONFIG	Shortcut to Connection setup. See 4.2 for details.																																				
F4	CHECK C.	Check connection settings. See 3.21.1 for details.																																				
ENTER	<p>Enters recorder starting date/time setup.</p> 																																					
Keys in Set start time window:																																						
	Selects parameter to be changed.																																					
	Modifies parameter.																																					
	Confirms selected option.																																					
	Exits Set start time window without modifications.																																					
	Selects parameter to be changed.																																					
	Modifies parameter.																																					
	Returns to the "RECORDERS" submenu.																																					

3.15 Waveform/Inrush recorder

Waveform recording is a powerful tool for troubleshooting and capturing current and voltage waveforms and inrushes. Waveform recorder saves a defined number of periods of voltage and current on a trigger occurrence. Each recording consists of pre-trigger interval (before trigger) and post-trigger interval (after trigger).

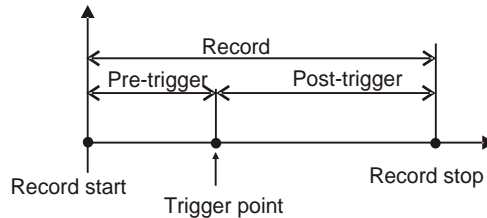

Figure 54: Triggering in waveform record

3.15.1 Setup

Waveform recorder setup menu is available from:
 MAIN MENU → MEASUREMENT SETUP → WAVE.REC.SETUP
 or
 MAIN MENU → RECORDERS → WAVEFORM REC → F3 (SETUP)

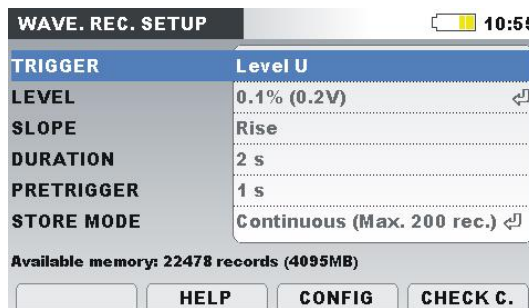

Figure 55: Waveform recorder setup screen

Table 57: Waveform recorder settings description and screen symbols

	Waveform recorder is active, waiting for trigger (presented only in case, when Waveform recorder is started)
	Waveform recorder is active, recording in progress (presented only in case, when Waveform recorder is started)
Trigger	Trigger source set up: <ul style="list-style-type: none"> • Events – triggered by voltage event (see 3.21.2); • Alarms – triggered by alarm activation (see 3.21.3); • Events & Alarms – triggered by alarm or event; • Level U – triggered by voltage level; • Level I – triggered by current level (inrush). • Interval – periodical trigger for given time period (each 10 minutes for example). Interval between two-time triggered waveforms in Interval trigger type
Level*	Voltage or current level in % of nominal voltage or current and in (V or A), which will trigger recording
Slope*	<ul style="list-style-type: none"> • Rise – triggering will occur only if voltage or current rise

	above given level
	<ul style="list-style-type: none"> • Fall - triggering will occur only if voltage or current fall below given level • Any – triggering will occur if voltage or current rise above or fall below given level
Duration	Record length.
Pretrigger	Recorded interval before triggering occurs.
Store mode	Store mode setup: <ul style="list-style-type: none"> • Single – waveform recording ends after first trigger; • Continuous (Max. 1500 record)– consecutive waveform recording until user stops the measurement or instrument runs out of storage memory. Every consecutive waveform recording will be treated as a separate record. By default, 200 records can be recorded. This value can be changed, if necessary. More than 200 records can slow down the instrument.

* Available only if Level U or Level I triggering is selected.

Table 58: Keys in Waveform recorder setup screen

Show help screens. See 5.1.19 for details.

F2

HELP

F3

CONFIG

Shortcut to CONNECTION SETUP menu. See 3.21.1 for details.

F4

CHECK C.

Check connection settings. See 3.21.1 for details.



Selects parameter to be changed.



Modifies parameter.



Enter into submenu (↵).

ESC Returns to the submenu.

3.15.2 Capturing waveform

After waveform recorder is started, instrument waits for trigger occurrence. This can be seen by observing status bar, where icon **W** is present. If trigger conditions are met, recording will be started.

Following screen opens when a user switches to WAVEFORM REC. view.



Figure 56: Waveform recorder capture screen

F1	START	Starts waveform recording.
F3	SETUP	Shortcut to WAVE. REC. SETUP menu. See 3.21.1 for details.
ESC		Returns to the "WAVEFORM REC. " menu.



Figure 57: Waveform recorder screen

F1	STOP	Stops waveform recording. Note: If user forces waveform recorder to stop before trigger occurs, no data will be recorded. Data recording occurs only when trigger is activated.
F2	TRIG	Manually generates trigger condition
ESC		Returns to the "WAVEFORM REC. " menu.

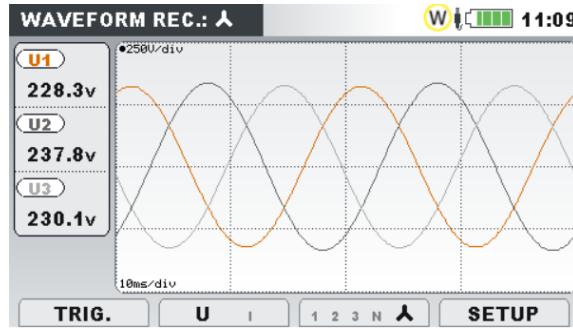

Figure 58: Waveform recorder scope screen

Table 59: Instrument screen symbols and abbreviations

	Waveform recorder is active, waiting for trigger
	Waveform recorder is active, recording in progress
U1, U2, U3, Un	True effective value of phase voltage: $U_{1Rms}, U_{2Rms}, U_{3Rms}, U_{NRms}$
U12, U23, U31	True effective value of phase-to-phase (line) voltage: $U_{12Rms}, U_{23Rms}, U_{31Rms}$
I1, I2, I3, In	True effective value of current: $I_{1Rms}, I_{2Rms}, I_{3Rms}, I_{NRms}$

Table 60: Keys in Waveform recorder capture screen

	TRIG.	Manually generates trigger condition (Active only if recording is in progress).
	U I U,I U/I U I U,I U/I U I U,I U/I U I U,I U/I	Selects which waveforms to show: Shows voltage waveform. Shows current waveform. Shows voltage and current waveforms on single graph. Shows voltage and current waveforms on separate graphs.
	1 2 3 N ^ 1 2 3 N ^ 1 2 3 N ^ 1 2 3 N ^ 1 2 3 N ^ 12 23 31 Δ 12 23 31 Δ 12 23 31 Δ 12 23 31 Δ	Selects between phase, neutral, all-phases and line view: Shows waveforms for phase L1. Shows waveforms for phase L2. Shows waveforms for phase L3. Shows waveforms for neutral channel. Shows waveforms for all phases. Shows waveforms for phase to phase voltage L12. Shows waveforms for phase to phase voltage L23. Shows waveforms for phase to phase voltage L31. Shows waveforms for all phase-to-phase voltages.
	SETUP	Switches to SETUP view. (Active only if recording in progress).
		Selects which waveform to zoom (only in U,I or U/I).
		Sets vertical zoom.

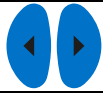

Sets horizontal zoom.



Returns to the “WAVEFORM RECORDER” setup screen.

3.15.3 Captured waveform

Captured waveforms can be viewed from the Memory list menu.

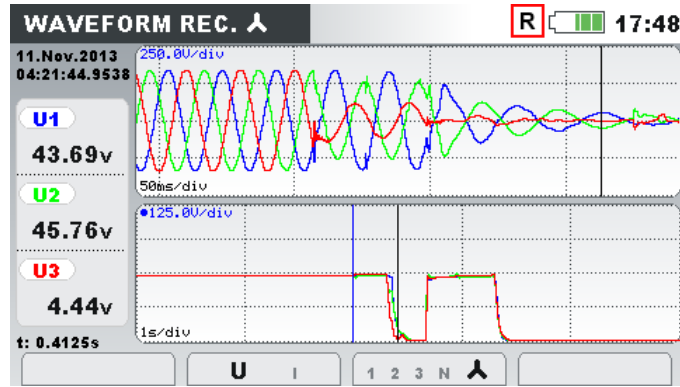





Figure 59: Captured waveform recorder screen

Table 61: Instrument screen symbols and abbreviations

R	Memory list recall. Shown screen is recalled from memory
t:	Cursor position in seconds (regarding to trigger time – blue line on graph)
u1(t), u2(t), u3(t), un(t)	Samples value of phase voltages U_1, U_2, U_3, U_N .
u12(t), u23(t), u31(t)	Samples value of phase to phase voltages U_{12}, U_{23}, U_{31} .
i1(t), i2(t), i3(t), in(t)	Samples value of phase currents I_1, I_2, I_3, I_N .
U1, U2, U3, Un	True effective half cycle phase voltage $U_{Rms(1/2)}$
U12, U23, U31	True effective half cycle phase to phase voltage $U_{Rms(1/2)}$
I1, I2, I3, In	True effective half cycle value $I_{Rms(1/2)}$

Table 62: Keys in captured waveform recorder screens

		Selects between the following options:
F2	U u, i u/	Shows voltage waveform.
	U u, i u/	Shows current waveform.
	U U , i u/	Shows voltage and current waveforms (single mode).
	U u, i U	Shows voltage and current waveforms (dual mode).
F3	1 2 3 N ^	Selects between phase, neutral, all-phases and view:
	1 2 3 N ^	Shows waveforms for phase L1.
	1 2 3 N ^	Shows waveforms for phase L2.
	1 2 3 N ^	Shows waveforms for phase L3.
	1 2 3 N ^	Shows waveforms for neutral channel.
1 2 3 N ^	Shows all phases waveforms.	

12 23 31 	Shows waveforms for phase to phase voltage L12.
12 23 31 	Shows waveforms for phase to phase voltage L23.
12 23 31 	Shows waveforms for phase to phase voltage L31.
12 23 31 	Shows all phase-to-phase waveforms.



Sets vertical zoom.



Moves cursor.



Toggles between sample value and true effective half cycle value at cursor position.
Toggles cursor between voltage and current (only in U,I or U/I).



Returns to the "MEMORY LIST" submenu.

3.16 Transient recorder

Transient is a term for **short, highly damped** momentary voltage or current disturbance. A transient recording is recording with the 1 MSamples/sec sampling rate. The principle of measurement is similar to waveform recording, but with higher sampling rate. In contrary to waveform recording, where recording is triggered based on RMS values, trigger in transient recorder is based on sample values.

Table 63: Transients on the low voltage network

Rise time	Cause
>100 μ s	<ul style="list-style-type: none"> • Operation of current-limiting fuses (amplitude up to 1 kV – 2 kV) • Activation of capacitors banks for power factor corrections (amplitude up to 2 -3 times of nominal peak voltage) • Transference of switching transient over voltages from MV to LV across MV/LV transformers by electromagnetic coupling (amplitude up to 1 kV)
1 μ s to 100 μ s	<ul style="list-style-type: none"> • Direct lightning stroke on the LV line conductors (amplitude up to 20 kV) • Induction coupling of a lightning stroke in a vicinity of an L line (amplitude up to 6 kV, high energy levels) • Resistive coupling associated with lightning currents flowing in the common earth paths of network (amplitude up to 10 kV) • Transference of transients from MV to LV by capacitive transformer coupling (amplitude up to 6 kV) • Operation of fuses (amplitude up to 2 kV, low energy content generally)
<1 μ s	<ul style="list-style-type: none"> • Local load switching of small inductive currents and short wiring (amplitude up to 2 kV) • Fast transients due to switching in LV by air-gap switches

Notes:

- To detect voltage transients at 3W connection, GND terminal should be connected according the proposed connection. Trigger selection should be selected as "GND";
- To detect voltage transients at Open Delta connection, GND terminal should be connected according the proposed connection. Trigger selection should be selected as "GND". For detecting transients in L2 current, also L2 current clamps should be connected;
- Transient measurements (high frequency events) on the secondary side of transformers (current and voltage transient measurements) could suppressed and/or distorted due to narrow frequency response of transformers. Same effect could be also present when measuring transients with the flex current clamps;
- For proper current transient measurements, it is obligatory to use fixed current range.

3.16.1 Setup

Transient recorder setup menu is available from:

MAIN MENU → MEASUREMENT SETUP → TRANSIENT SETUP

or

MAIN MENU → RECORDERS → TRANSIENT REC. → F3 (SETUP)

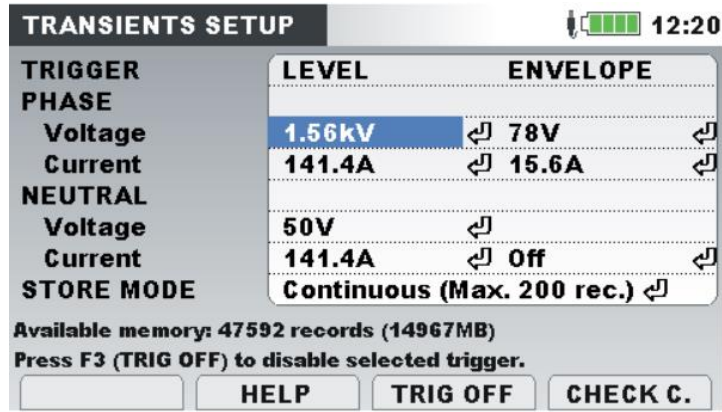

Figure 60: Transient recorder setup screen

Table 64: Transient recorder settings description and screen symbols

Envelope: Trigger value is based on envelope within voltage/current that is expected. As reference, voltage/current waveform from previous cycle is taken. If current sample is not within envelope, triggering will occur. See 5.1.20 for details.

Phase voltage limits:

Minimum value: $0.0055 * U_{nom} * \text{sqrt}(2)$
 Maximum value: $1.1 * U_{nom} * \text{sqrt}(2)$

Neutral voltage limits → not available

Phase/Neutral current limits:

Minimum value: $0.0055 * I_{nom} * \text{sqrt}(2)$
 Maximum value: $1.1 * I_{nom} * \text{sqrt}(2)$

Trigger

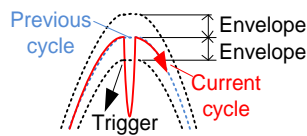

Level: Trigger will occur if any sample within period is greater than defined absolute trigger level. Level is defined as absolute expected monitoring value. See 5.1.20 for details.

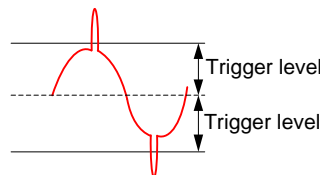



Phase voltage limits:

Minimum value: U_{nom}
 Maximum value: $5500 * VT \text{ ratio}$

Neutral voltage limits:

	<p>Minimum value: $0,0055 * U_{nom} * \sqrt{2}$ Maximum value: 1 V</p> <p>Phase/Neutral current limits: Minimum value: $0.1 * \sqrt{2} * I_{nom}$ Maximum value: $1.5 * \sqrt{2} * I_{nom}$</p>
Trigger type	<p>PHASE: U: Trigger on transients at active voltage (phase/line) channels I: Trigger on transients at active phase current channels</p> <p>NEUTRAL: Un: Trigger on transients at Ground to Neutral voltage channel In: Trigger on transients at Neutral current channel</p> <p>Note: Minimum current trigger selection: $10\% * I_{nom} * \sqrt{2}$ Maximum current trigger selection: $150\% * I_{nom} * \sqrt{2}$</p>
Store mode	<p>Store mode setup:</p> <ul style="list-style-type: none"> • Single – transient recording ends after first trigger • Continuous (Max. 1500 rec.) – consecutive transient recording until user stops the measurement or instrument runs out of storage memory. Every consecutive transient recording will be treated as a separate record. By default, 200 records can be recorded. This value can be changed, if necessary. More than 200 records can slow down the instrument.

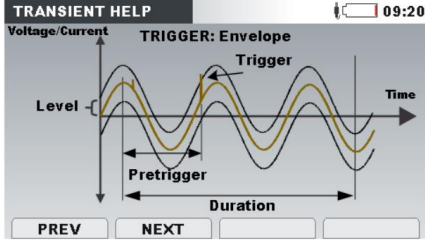
Table 65: Keys in Transient recorder setup screen

F2	HELP	<p>Show triggering help screens (valid for voltage and current) See 5.1.20 for details.</p> 
F3	TRIG OFF	Deleting the trigger selection
F4	CHECK C.	Check connection settings. See 3.21.1 for details.
		Selects parameter to be changed.
		Modifies parameter.



Enter into submenu (↵).



Returns to the submenu.

3.16.2 Capturing transients

After transient recorder is started, instrument waits for trigger occurrence. This can be seen by observing status bar, where icon is present. If trigger conditions are met, recording will be started.

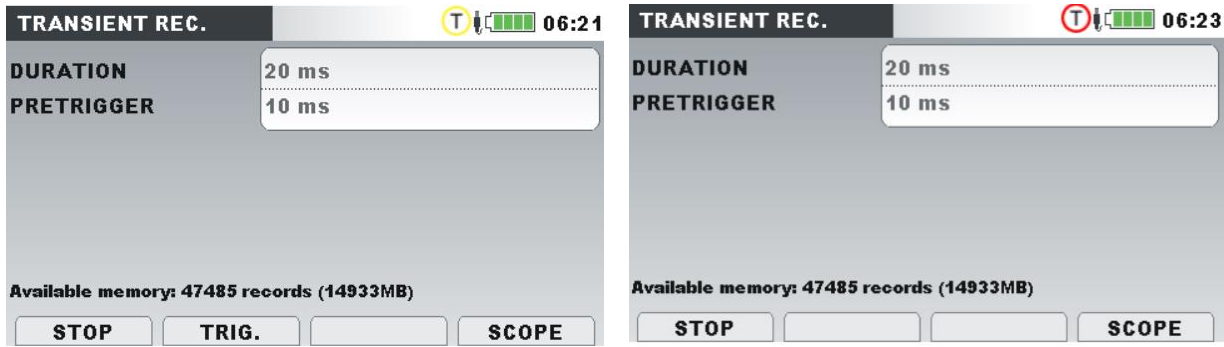



Figure 61: Transient recorder capture screen (waiting phase/recording)

Table 66: Instrument screen symbols and abbreviations

	Transient recorder is active, waiting for trigger
	Transient recorder is active, recording in progress
U1, U2, U3, Un	True 1-cycle effective value of phase voltage: $U_{1Rms}, U_{2Rms}, U_{3Rms}, U_{NRms}$
U12, U23, U31	True 1-cycle effective value of phase-to-phase voltage: $U_{12Rms}, U_{23Rms}, U_{31Rms}$
I1, I2, I3, In	True 1-cycle effective value of current: $I_{1Rms}, I_{2Rms}, I_{3Rms}, I_{NRms}$

Table 67: Keys in Transient recorder capture screen

	TRIG.	Manually generates trigger condition (Active only if recording is in progress).
	U U,I U/I	Selects which waveforms to show: Shows voltage waveform.
	I U,I U/I	Shows current waveform.
	U U,I U/I	Shows voltage and current waveforms on single graph.
	U U,I U/I	Shows voltage and current waveforms on separate graphs.
	1 2 3 N ▲	Selects between phase, neutral, all-phases and line view: Shows waveforms for phase L1.
	1 2 3 N ▲	Shows waveforms for phase L2.
	1 2 3 N ▲	Shows waveforms for phase L3.
	1 2 3 N ▲	Shows waveforms for neutral channel.
	1 2 3 N ▲	Shows waveforms for all phases.
	12 23 31 Δ	Shows waveforms for phase to phase voltage L12.
	12 23 31 Δ	Shows waveforms for phase to phase voltage L23.
12 23 31 Δ	Shows waveforms for phase to phase voltage L31.	

12 23 31 Δ	Shows waveforms for all phase-to-phase voltages.
F4 SETUP	Switches to SETUP view (Active only if recording in progress).
	Sets vertical zoom.
ENTER	Selects which waveform to zoom (only in U,I or U/I).
ESC	Returns to the "TRANSIENT RECORDER" screen.

3.16.3 Captured transients

Captured transient records can be viewed from the Memory list where captured waveforms can be analysed. Trigger occurrence is marked with the blue line, while cursor position line is marked in black.

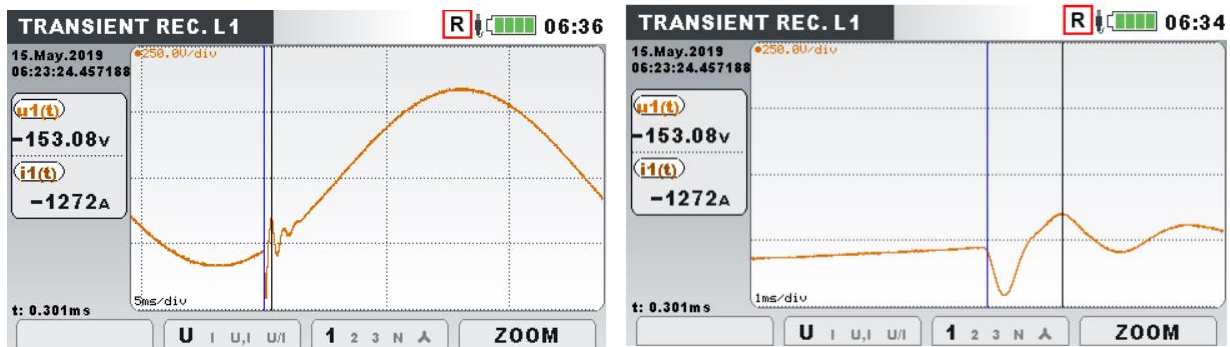

Figure 62: Captured transient recorder screen

Table 68: Instrument screen symbols and abbreviations

R	Memory list recall. Shown screen is recalled from memory
t:	Cursor position regarding to trigger time (blue line on graph)
u1(t), u2(t), u3(t), un(t)	Samples value of phase voltages U_1, U_2, U_3, U_N .
u12(t), u23(t), u31(t)	Samples value of phase to phase voltages U_{12}, U_{23}, U_{31} .
i1(t), i2(t), i3(t), in(t)	Samples value of phase currents I_1, I_2, I_3, I_N .

Table 69: Keys in captured transient recorder screens

		Selects between the following options:
F2	U I U,I U/I	Shows voltage waveform.
	U I U,I U/I	Shows current waveform.
	U I U,I U/I	Shows voltage and current waveforms (single mode).
	U I U,I U/I	Shows voltage and current waveforms (dual mode).
F3		Selects between phase, neutral, all-phases and view:
	1 2 3 N Δ	Shows waveforms for phase L1.

	Shows waveforms for phase L2.
	Shows waveforms for phase L3.
	Shows waveforms for neutral channel.
	Shows waveforms for all phases.
	Shows waveforms for phase to phase voltage L12.
	Shows waveforms for phase to phase voltage L23.
	Shows waveforms for phase to phase voltage L31.
	Shows waveforms for all phase-to-phase voltages.
	ZOOM Sets horizontal zoom
	Sets vertical zoom.
	Moves cursor.
	Toggles cursor between voltage and current (only in U,I or U/I).
	Returns to the “MEMORY LIST” submenu.

3.17 Events table

In this table captured voltage dips, swells and interrupts are shown. Note that events appear in the table after finishing, when voltage return to the normal value. All events can be grouped according to IEC 61000-4-30. Additionally, for troubleshooting purposes events can be separated by phase. This is toggled by pressing function key F1. Event table is active only during general recording.

3.17.1 Group view

In this view voltage event are grouped according to IEC 61000-4-30 (see section 5.1.12 for details). Table where events are summarized is shown below. Each line in table represents one event, described by event number, event start time, duration and level. Additionally, in colon “T” event characteristics (Type) is shown (see table below for details).

EVENTS					
Date 29.01.2019					
No	L	START	T	Level	Duration
1	1	11:48:21.983	D	205.48	0h00m0.090s
2	1	11:48:59.012	D	3.87	0h00m0.100s
3	1 2 3	11:50:46.831	DI	0.23	0h00m0.120s
4	1	11:52:28.841	D	4.71	0h00m0.110s
5	1	11:56:12.190	D	0.25	0h01m13.759s

At the bottom of the screen, there are controls: a person icon, a 'Ph.' button, an 'ALL INT' button, and a 'VIEW' button.

Figure 63: Voltage events in group view screen

By pressing “ENTER” on particular event we can examine event details. Event is split by phase events and sorted by start time.







No	L	START	T	Level	Duration
4	1	11:50:46.831	D	0.23	0h00m0.120s
5	3	11:50:46.834	D	3.45	0h00m0.110s
6	2	11:50:46.838	D	2.99	0h00m0.110s
7	2	11:50:46.848	I	2.99	0h00m0.080s
8	1	11:50:46.851	I	0.23	0h00m0.080s
9	3	11:50:46.854	I	3.45	0h00m0.080s

Figure 64: Voltage event in detail view screen

Table 70: Instrument screen symbols and abbreviations

Date	Date when selected event has occurred
No.	Unified event number (ID)
L	Indicate phase or phase-to-phase voltage where event has occurred: 1 – event on phase U_1 2 – event on phase U_2 3 – event on phase U_3 12 – event on voltage U_{12} 23 – event on voltage U_{23} 31 – event on voltage U_{31} Note: This indication is shown only in event details, since one grouped event can have many phase events.
Start	Event start time (when first $U_{Rms(1/2)}$ value crosses threshold.
T	Indicates type of event or transition: D – Dip I – Interrupt S – Swell
Level	Minimal or maximal value in event U_{Dip} , U_{Int} , U_{Swell}
Duration	Event duration.

Table 71: Keys in Events table group view screens

		Group view is shown. Press to switch on “PHASE” view.
		Phase view is shown. Press to switch on “GROUP” view.
		Shows all types of events (dips and swell). Interrupts are treated as special case of voltage dip event. START time and Duration in table is referenced to complete voltage event.

No	L	START	T	Level	Duration
1	1	11:48:21.983	D	205.48	0h00m0.090s
2	1	11:48:59.012	D	3.87	0h00m0.100s
3	1 2 3	11:50:46.831	DI	0.23	0h00m0.120s
4	1	11:52:28.841	D	4.71	0h00m0.110s
5	1	11:56:12.190	D	0.25	0h01m13.759s

Shows poly-phase voltage interrupts only, according to the IEC 61000-4-30 requirements. START time and Duration in table is referenced to voltage interrupt only.

ALL INT

No	L	START	T	Level	Duration
3	1 2 3	11:50:46.854	I	0.23	0h00m0.073s

Shows selected waveform and inrush view.

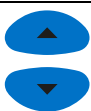
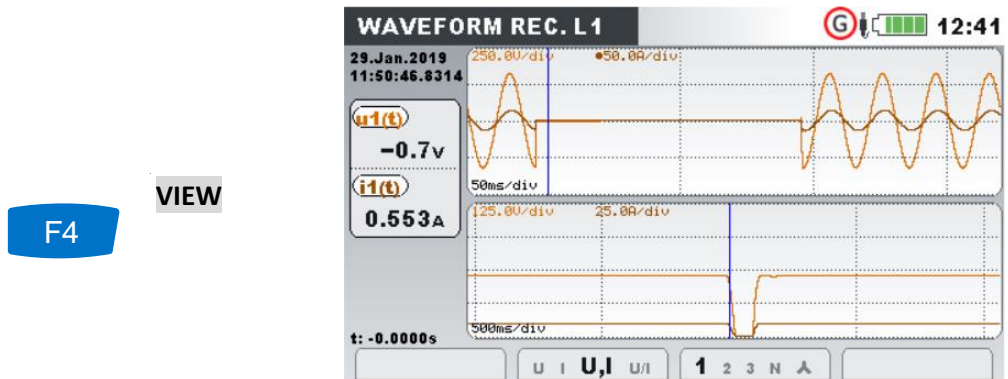

Selects event.



Enters detail event view.



Returns to Events table group view screen.
Returns to "RECORDERS" submenu.

3.17.2 Phase view

In this view voltage events are separated by phases. This is convenient view for troubleshooting. Additionally, user can use filters in order to observe only particular type of event on a specific phase. Captured events are shown in a table, where each line contains one phase event. Each event has an

event number, event start time, duration and level. Additionally, in colon “T” type of event is shown (see table below for details).

No	L	START	T	Level	Duration
1	1	11:48:21.983	D	205.48	0h00m0.090s
2	1	11:48:59.012	D	3.87	0h00m0.100s
3	1	11:48:59.032	I	3.87	0h00m0.070s
4	1	11:50:46.831	D	0.23	0h00m0.120s
5	3	11:50:46.834	D	3.45	0h00m0.110s
6	2	11:50:46.838	D	2.99	0h00m0.110s

Figure 65: Voltage events screens

You can also see details of each individual voltage event and waveform/inrush view of all events. Statistics show count registers for each individual event type by phase.

Table 72: Instrument screen symbols and abbreviations

Date	Date when selected event has occurred
No.	Unified event number (ID)
L	Indicate phase or phase-to-phase voltage where event has occurred: 1 – event on phase U_1 2 – event on phase U_2 3 – event on phase U_3 12 – event on voltage U_{12} 23 – event on voltage U_{23} 31 – event on voltage U_{31}
Start	Event start time (when first $U_{Rms(1/2)}$ value crosses threshold.
T	Indicates type of event or transition: D – Dip I – Interrupt S – Swell
Level	Minimal or maximal value in event U_{Dip} , U_{Intr} , U_{Swell}
Duration	Event duration.

Table 73: Keys in Events table phase view screens

		Group view is shown. Press to switch on “PHASE” view.
		Phase view is shown. Press to switch on “GROUP” view.
		Filters events by type: Shows all event types.

▲ **DIP INT SWELL** Shows dips only.
▲ **DIP INT SWELL** Shows interrupts only.
▲ **DIP INT SWELL** Shows swells only.

Filters events by phase:

1 2 3 T Shows only events on phase L1.
1 2 3 T Shows only events on phase L2.
1 2 3 T Shows only events on phase L3.
1 2 3 T Shows events on all phases.
12 23 31 T Shows only events on phases L12.
12 23 31 T Shows only events on phases L23.
12 23 31 T Shows only events on phases L31.
12 23 31 T Shows events on all phases.

F3 Shows selected waveform and inrush view.

F4 **VIEW**

▲ ▼ Selects event.

ENTER Enters detail event view.

ESC Returns to Events table phase view screen.
ESC Returns to the "RECORDERS" submenu.

3.18 Alarms table

This screen shows list of alarms which went off. Alarms are displayed in a table, where each row represents an alarm. Each alarm is associated with a start time, phase, type, slope, min/max value and duration (see 3.21.3 for alarm setup and 5.1.14 for alarm measurement details).

ALARMS						
Date 30.01.2019						
START	L	T	Slope	Min/Max	Duration	
07:32:02.800	T	P+	Rise	397.9 kW	19.201 sec	
07:32:09.800	1	U	Rise	258.2 V	2.800 sec	
07:32:31.001	T	P+	Rise	1316 kW	1.200 sec	
07:32:46.401	1	U	Rise	298.0 V	1.800 sec	
07:33:08.800	1	U	Rise	235.8 V	6.200 sec	
07:33:09.000	1	Uh5	Rise	14.8 %	6.000 sec	

Figure 66: Alarms list screen



Table 74: Instrument screen symbols and abbreviations

Date	Date when selected alarm has occurred
Start	Selected alarm start time (when first U_{Rms} value cross threshold)
L	Indicate phase or phase-to-phase voltage where event has occurred: 1 – alarm on phase L_1 2 – alarm on phase L_2 3 – alarm on phase L_3 12 – alarm on line L_{12} 23 – alarm on line L_{23} 31 – alarm on line L_{31}
Slope	Indicates alarms transition: <ul style="list-style-type: none"> • Rise – parameter has over-crossed threshold • Fall – parameter has under-crossed threshold
Min/Max	Minimal or maximal parameter value during alarm occurrence
Duration	Alarm duration.

Table 75: Keys in Alarms table screens

		Filters alarms according to the following parameters:
	▲ UIF C. Pwr F. Pwr NF. Pwr Flick Sym H iH Sig Temp	All alarms.
	▲ UIF C. Pwr F. Pwr NF. Pwr Flick Sym H iH Sig Temp	Voltage alarms.
	▲ UIF C. Pwr F. Pwr NF. Pwr Flick Sym H iH Sig Temp	Combined power alarms.
	▲ UIF C. Pwr F. Pwr NF. Pwr Flick Sym H iH Sig Temp	Fundamental power alarms.
F2	▲ UIF C. Pwr F. Pwr NF. Pwr Flick Sym H iH Sig Temp	Nonfundamental power alarms.
	▲ UIF C. Pwr F. Pwr NF. Pwr Flick Sym H iH Sig Temp	Flicker alarms.
	▲ UIF C. Pwr F. Pwr NF. Pwr Flick Sym H iH Sig Temp	Unbalance alarms.
	▲ UIF C. Pwr F. Pwr NF. Pwr Flick Sym H iH Sig Temp	Harmonics alarms.
	▲ UIF C. Pwr F. Pwr NF. Pwr Flick Sym H iH Sig Temp	Interharmonics alarms.
	▲ UIF C. Pwr F. Pwr NF. Pwr Flick Sym H iH Sig Temp	Signalling alarms.
	▲ UIF C. Pwr F. Pwr NF. Pwr Flick Sym H iH Sig Temp	Temperature alarms.
F3		Filters alarms according to phase on which they occurred:

1 2 3 N 12 23 31 T ▲	Shows only alarms on phase L1.
1 2 3 N 12 23 31 T ▲	Shows only alarms on phase L2.
1 2 3 N 12 23 31 T ▲	Shows only alarms on phase L3.
1 2 3 N 12 23 31 T ▲	Shows only alarms on neutral channel.
1 2 3 N 12 23 31 T ▲	Shows only alarms on phases L12.
1 2 3 N 12 23 31 T ▲	Shows only alarms on phases L23.
1 2 3 N 12 23 31 T ▲	Shows only alarms on phases L31.
1 2 3 N 12 23 31 T ▲	Shows only alarms on channels which are not channel dependent
1 2 3 N 12 23 31 T ▲	Shows all alarms.

	Selects an alarm.
	

	Returns to the "RECORDERS" submenu.
---	-------------------------------------

3.19 Rapid voltage changes (RVC) table

In this table captured RVC events are shown. Events appear in the table after finish, when voltage is in the steady state. RVC events are measured and represented according to IEC 61000-4-30. See 5.1.15 for details.

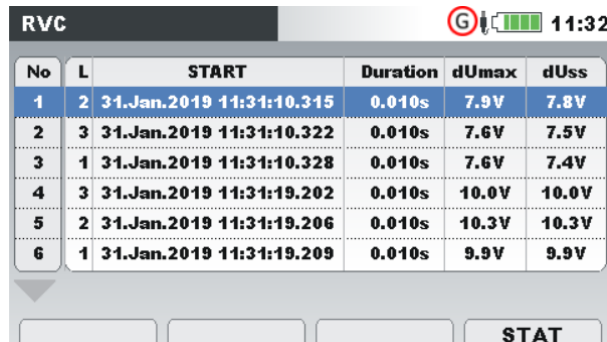

No	L	START	Duration	dUmax	dUss
1	2	31.Jan.2019 11:31:10.315	0.010s	7.9V	7.8V
2	3	31.Jan.2019 11:31:10.322	0.010s	7.6V	7.5V
3	1	31.Jan.2019 11:31:10.328	0.010s	7.6V	7.4V
4	3	31.Jan.2019 11:31:19.202	0.010s	10.0V	10.0V
5	2	31.Jan.2019 11:31:19.206	0.010s	10.3V	10.3V
6	1	31.Jan.2019 11:31:19.209	0.010s	9.9V	9.9V

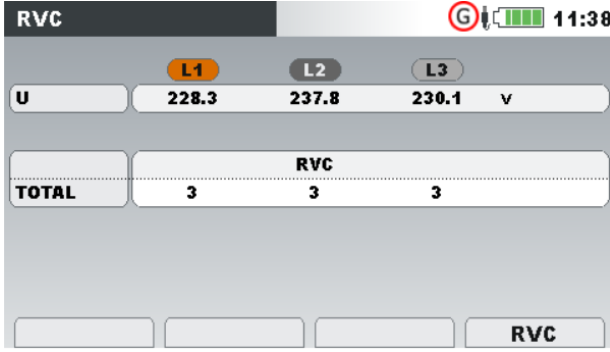

Figure 67: RVC Events table group view screen

Table 76: Instrument screen symbols and abbreviations

No.	Unified event number (ID)
L	Indicate phase or phase-to-phase voltage where event has occurred: 1 – event on phase U_1 2 – event on phase U_2 3 – event on phase U_3 12 – event on voltage U_{12} 23 – event on voltage U_{23} 31 – event on voltage U_{31}
Start	Event start time (when first $U_{Rms(1/2)}$ value crosses threshold.
Duration	Event duration.
dMax	ΔU_{max} - maximum absolute difference between any of the $U_{Rms(1/2)}$

	values during the RVC event and the final arithmetic mean 100/120 $U_{Rms(1/2)}$ value just prior to the RVC event.
dUss	ΔUss - is the absolute difference between the final arithmetic mean 100/120 $U_{Rms(1/2)}$ value just prior to the RVC event and the first arithmetic mean 100/120 $U_{Rms(1/2)}$ value after the RVC event.

Table 77: Keys in RVC Events table group view screens

	Shows event statistics (phase by phase).
	
	Returns to RVC Events table group view screen.
	Returns to RVC Events table group view screen. Returns to "RECORDERS" submenu.

3.20 Memory List

Using this menu user can view and browse saved records. By entering this menu, information about records is shown.

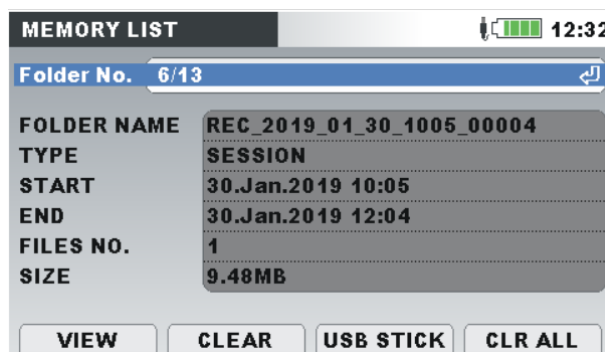





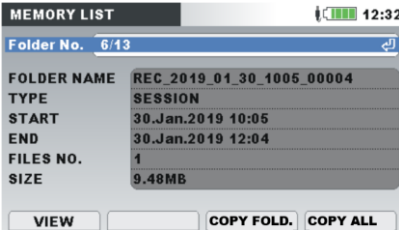

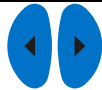



Figure 68: Memory list screen (Folder structure)

Table 78: Instrument screen symbols and abbreviations

Folder No.	Selected Folder number for which details are shown / Number of all folders
FOLDER NAME	Folder name on SD Card. By convention file names are created by following rules: REC_YYYY_MM_DD_HHMM_xxxxx, where: <ul style="list-style-type: none"> REC represent Folder type

	<ul style="list-style-type: none"> • YYYY represent actual year • HH represent actual month • DD represent actual day • HHMM represent actual hour/minutes • xxxxx record number 00000 ÷ 99999 (running index)
TYPE	<p>Indicates type of folder, which can be one of following:</p> <ul style="list-style-type: none"> • Root (for snapshot data), • Session (for recorded data).
START	Folder creation start time.
END	Folder stop time.
FILES NO.	Number of recorder's and snapshot's files
SIZE	Record size in kilobytes (kB) or megabytes (MB).

Table 79: Keys in Memory list (Folder) screen

	VIEW	Views details of currently selected folder.
	CLEAR	Clears selected folder structure.
	USB STICK	Enable USB memory stick support.
		
	COPY FOLD.	Copy selected folder to USB
	COPY ALL	Copy all data from SD card to USB
		Opens confirmation window for clearing all saved records.
		Keys in confirmation window:
	CLR ALL	 Selects YES or NO.
		 Confirms selection.
		 Exits confirmation window without clearing saved records.
		Browses through folders (next or previous folder).
		Returns to the "RECORDERS" submenu.

By pressing  (VIEW) button, details of selected folder are presented:

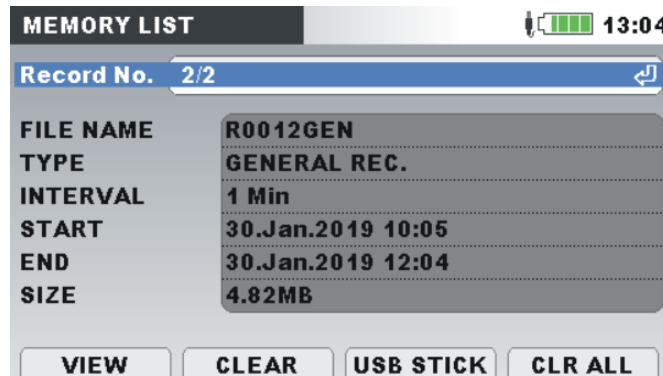





Figure 69: Memory list screen (Recorder data)

Table 80: Instrument screen symbols and abbreviations

Record No	Selected record number, for which details are shown / Number of all records.
FILE NAME	Record name under selected folder structure on SD Card. By convention file names are created by following rules: Rxxxxyyy.REC , where: <ul style="list-style-type: none"> • xxxx if record number 0000 ÷ 9999 • yyy represent record type <ul style="list-style-type: none"> ○ WAW – waveform record (samples values) ○ INR – inrush record (RMS values) ○ SNP – waveform snapshot ○ TRA – transient record ○ GEN – general record. General record generates also AVG, EVT, PAR, ALM, SEL files, which can be found on SD Card and are imported into PowerView.
Type	Indicates type of record, which can be one of following: <ul style="list-style-type: none"> • Snapshot, • Transient record, • Waveform record, • Inrush record, • General record.
Interval	General record recording interval (integration period)
Start	General record start time.
End	General record stop time.
Size	Record size in kilobytes (kB) or megabytes (MB).

Table 81: Keys in Memory list screen

	VIEW	Views details of currently selected record.
	CLEAR	Clears selected record.
	USB STICK	Enable USB memory stick support.

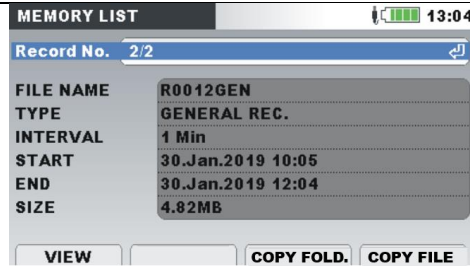

**COPY FOLD.
COPY FILE**

Copy all files from selected folder to USB stick.
Copy selected file to USB stick.

Opens confirmation window for clearing all saved records under selected folder.

Keys in confirmation window:



CLR ALL

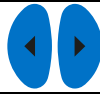

Selects YES or NO.



Confirms selection.



Exits confirmation window without clearing saved records.



Browses through records (next or previous record).



Returns to the "Folder" submenu.
Returns to the "RECORDERS" submenu.

3.20.1 General Record

This type of record is made by GENERAL RECORDER. Record front page is similar to the GENERAL RECORDER setup screen, as shown on figure below.

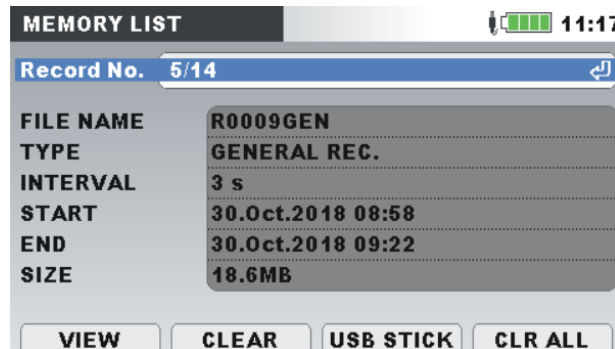



Figure 70: Front page of General record in MEMORY LIST menu

Table 82: Recorder settings description

Record No.	Selected record number, for which details are shown.
FILE NAME	Record name on SD Card
Type	Indicate type of record: General record.
Interval	General record recording interval (integration period)
Start	General record start time.
End	General record stop time.
Size	Record size in kilobytes (kB) or megabytes (MB).

Table 83: Keys in General record front page screen

	VIEW	Switches to the CHANNELS SETUP menu screen.
---	-------------	---











Particular signal groups can be observed by pressing on F1 key (VIEW).



Keys in CHANNELS SETUP menu screen:



Selects particular signal group.

			 	Enters particular signal group (TREND view).
				Exits to MEMORY LIST menu.
	CLEAR	Clears the last record. In order to clear complete memory, delete records one by one. Opens confirmation window for clearing all saved records.		
		Keys in confirmation window:		
	CLR ALL		Selects YES or NO.	
			Confirms selection.	
			Exits confirmation window without clearing saved records.	
	Browses through records (next or previous record).			
	Selects parameter (only in CHANNELS SETUP menu).			
	Returns to the "RECORDERS" submenu.			

By pressing  **VIEW**, in CHANNELS SETUP menu, TREND graph of selected channel group will appear on the screen. Typical screen is shown on figure below.

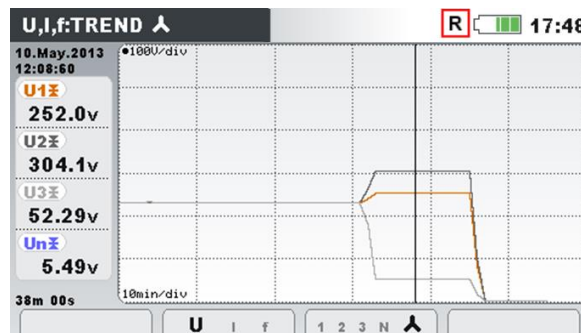









Figure 71: Viewing recorder U,I,f TREND data

Table 84: Instrument screen symbols and abbreviations

	Memory list recall. Shown screen is recalled from memory.
	Indicates position of the cursor at the graph.
U1, U2 U3, Un:	Maximal () , average () and minimal () recorded value of phase voltage U_{1Rms} , U_{2Rms} , U_{3Rms} , U_{NRms} , for time interval selected by cursor.
U12, U23, U31	Maximal () , average () and minimal () recorded value of phase-to-phase

















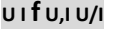

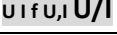
	voltage U_{12Rms} , U_{23Rms} , U_{31Rms} for time interval selected by cursor.
Ip:	Maximal () , average () and minimal () recorded value of current I_{1Rms} , I_{2Rms} , I_{3Rms} , I_{NRms} , for time interval selected by cursor.
38m 00s	Time position of cursor regarding to the record start time.
10.May.2013 12:08:50	Time clock at cursor position.

Table 85: Keys in Viewing recorder U,I,f TREND screens

		Selects between the following options:
		Shows voltage trend.
		Shows current trend.
		Shows frequency trend.
		Shows voltage and current trends (single mode).
		Shows voltage and current trends (dual mode).
		Selects between phase, neutral, all-phases and view:
		Shows trend for phase L1.
		Shows trend for phase L2.
		Shows trend for phase L3.
		Shows trend for neutral channel.
		Shows all phases trends.
		Shows trend for phases L12.
		Shows trend for phases L23.
		Shows trend for phases L31.
		Shows all phase to phase trends.
		Moves cursor and select time interval (IP) for observation.
		Returns to the "CHANNELS SETUP" menu screen.

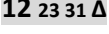
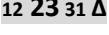
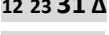
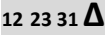
Note: Other recorded data (power, harmonics, etc.) has similar manipulation principle as described in previous sections of this manual.

3.20.2 Waveform snapshot

This type of record can be made by using  key (press and hold  key). Snapshot is performed only on the measurement screens.

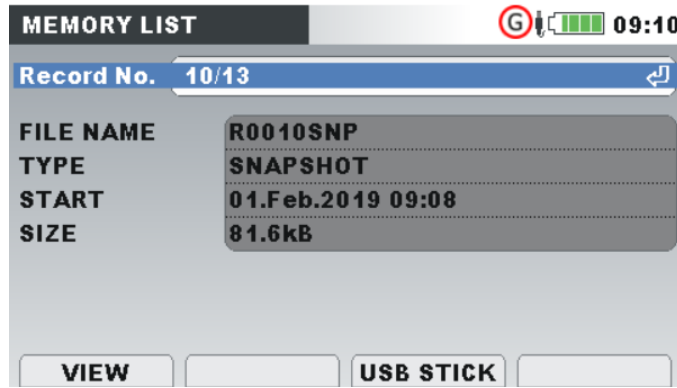

Figure 72: Front page of Snapshot in MEMORY LIST menu

Table 86: Recorder settings description

Record No.	Selected record number, for which details are shown.
FILE NAME	Record name on SD Card
Type	Indicate type of record: <ul style="list-style-type: none"> • Snapshot.
Start	Record start time.
Size	Record size in kilobytes (kB).

Table 87: Keys in Snapshot record front page screen

 Switches to CHANNELS SETUP menu screen.

 Particular signal group can be observed by pressing on F1 key (VIEW).

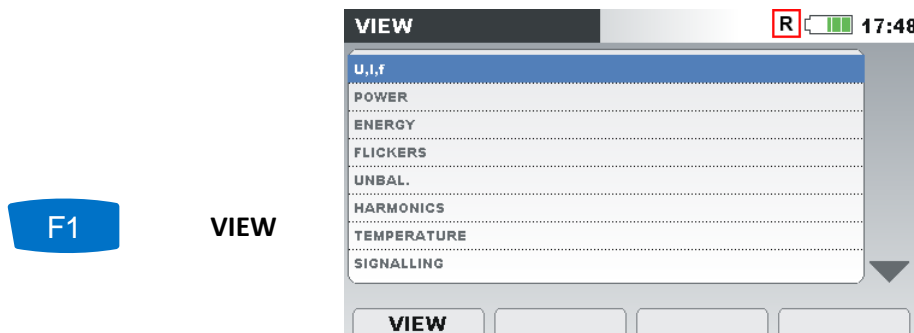

Keys in CHANNELS SETUP menu screen:



Selects particular signal group.



Enters particular signal group (METER or SCOPE view).

ENTER

ESC Exits to MEMORY LIST menu.

F3 **USB STICK** Enable USB memory stick support.

MEMORY LIST G R 09:10

Record No. 10/13

FILE NAME	R0010SNP
TYPE	SNAPSHOT
START	01.Feb.2019 09:08
SIZE	81.6kB

VIEW

COPY FOLD. Copy all files from selected folder to USB stick.

COPY FILE Copy selected file to USB stick.

 Browses through records (next or previous record).

ESC Returns to the "Folder" submenu.
Returns to the "RECORDERS" submenu.

By pressing **F1** **VIEW** in CHANNELS SETUP menu METER screen will appear. Typical screen is shown on figure below.

	L1	L2	L3	N
UL	228.3	237.8	230.1 _v	236.8 _v
ThdU	0.08	0.08	0.08%	0.08%
IL	197.2	197.0	197.2 _A	197.4 _A
ThdI	0.10	0.11	0.10%	0.10%
f	49.996			Hz

1 2 3 N **SCOPE**

Figure 73: U,I,f meter screen in recalled snapshot record

Note: For more details regarding manipulation and data observing see previous sections of this manual.
Note: Initial WAVEFORM SNAPSHOT is automatically created at the start of GENERAL RECORDER.

3.20.3 Waveform/inrush record

This type of record is made by Waveform recorder. For details regarding manipulation and data observing see section Captured waveform 3.15.3.

3.20.4 Transients record

This type of record is made by Transient recorder. For details regarding manipulation and data observing see section 3.16.3.

3.21 Measurement Setup submenu

From the “MEASUREMENT SETUP” submenu measurement parameters can be reviewed, configured and saved.

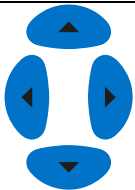

Figure 74: MEASUREMENT SETUP submenu

Table 88: Description of Measurement setup options

Connection setup	Setup measurement parameters.
Event setup	Setup event parameters.
Alarm setup	Setup alarm parameters.
Signalling setup	Setup signalling parameters.
RVC setup	Setup RVC parameters.
Measuring methods	Selection of measurement method (Modern (IEEE 1459), Classic (Vector), Classic (Arithmetic)).
Transient setup	Setup of parameters for Transient recorder.
Inrush setup	Setup of parameters for Waveform/Inrush recorder.
Wave. Rec. setup	Setup of parameters for Waveform/Inrush recorder.

Table 89: Keys in Measurement setup submenu screen



Selects option from the “MEASUREMENT SETUP” submenu.



Enters the selected option.



Returns to the “MAIN MENU” screen.

3.21.1 Connection setup

In this menu user can setup connection parameters, such as nominal voltage, frequency, etc. After all parameters are provided, instrument will check if given parameters complies with measurements. In case of incompatibility instrument will show Connection check warning (✘) before leaving menu.



Figure 75: "CONNECTION SETUP" screen

Table 90: Description of Connection setup

Set nominal voltage according to the network voltage. If voltage is measured over potential transformer then press ENTER for setting transformer parameters:

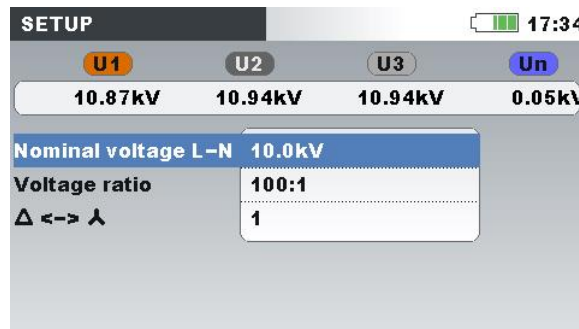

Nominal voltage

Voltage ratio: Potential transformer ratio $\Delta \leftrightarrow \ast$:

Transformer type	Primary	Secondary	Symbol	Additional transformer ratio
Delta	Star		$\Delta \rightarrow \ast$	$1/\sqrt{3}$
Star	Delta		$\ast \rightarrow \Delta$	$\sqrt{3}$
Star	Star		$\ast \rightarrow \ast$	1
Delta	Delta		$\Delta \rightarrow \Delta$	1

Note: Instrument can always measure accurately at up to 150% of selected nominal voltage.

Phase Curr. Clamps
Neutral Curr. Clamps

Selects phase current clamps for phase current inputs.
Selects neutral current clamps for neutral current input.

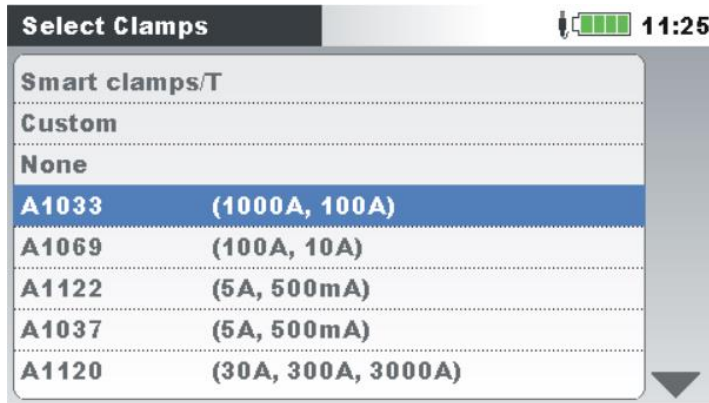

Note: For Smart clamps (A 1502, A 1227, A 1281, ...) always select “Smart clamps”. Check in the Metrel General Catalogue, which clamps are developed as “Smart clamps”).

Note: Use “None” option for voltage measurements only.

Note: See section 4.2.3 for details regarding further clamps settings.

Method of connecting the instrument to multi-phase systems (see 4.2.1 for details).

- **1W:** 1-phase 3-wire system;

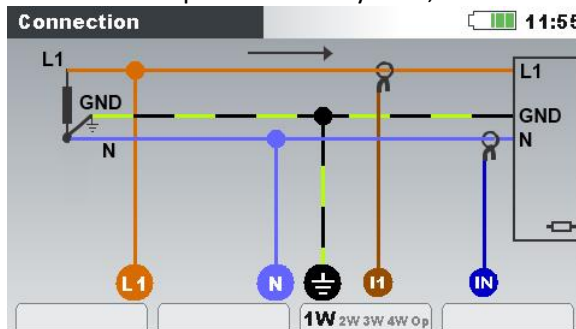

- **2W:** 2-phase 4-wire system;

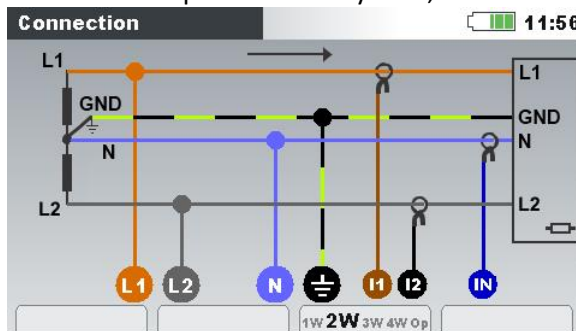

- **3W:** 3-phase 3-wire system;

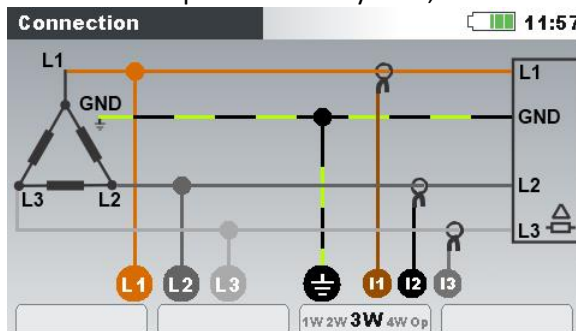

- **4W:** 3-phase 4-wire system;

Connection

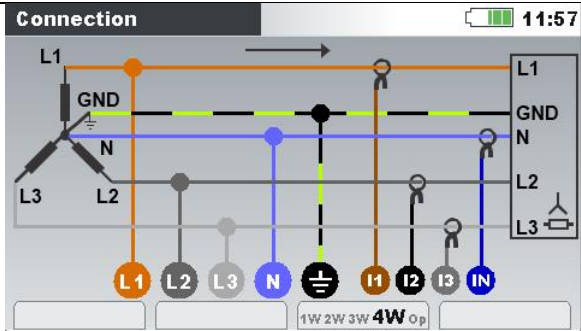

- **OpenD:** 3-phase 2 -wire (Open Delta) system.

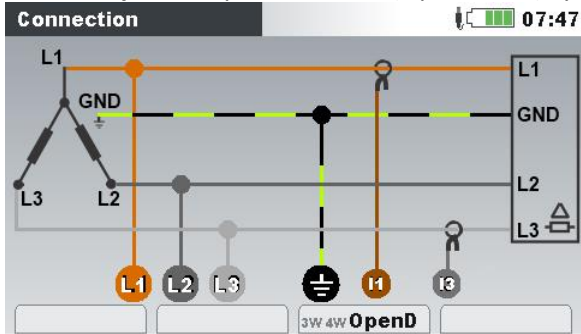

- **INV1W:** Single phase inverter connection.

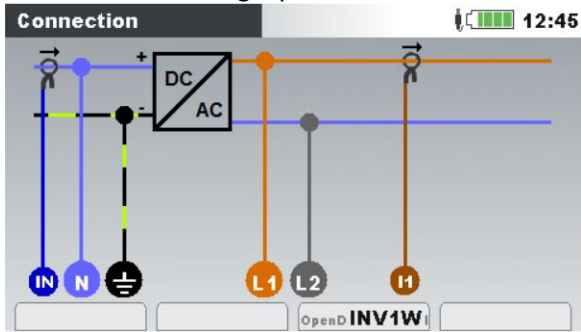

- **INV3W:** Single phase inverter connection.

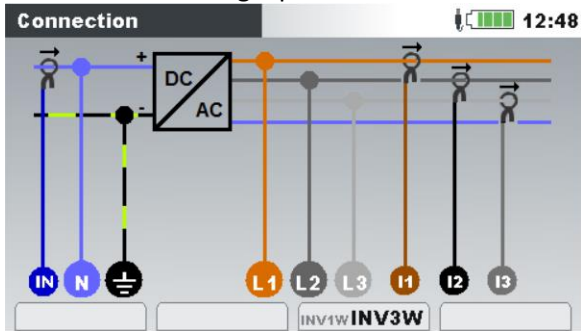

Synchronization

Synchronization channel. This channel is used for instrument synchronization to the network frequency. Also, a frequency measurement is performed on that channel. Depending on **Connection** user can select:

- **1W, 2W, 4W, INV1W:** U1 or I1.
- **3W, OpenD, INV3W:** U12, or I1.

System frequency

Select system frequency. According to this setting 10 or 12 cycle interval will be used for calculus (according to IEC 61000-4-30) at 50/60Hz:

- 50 Hz – 10 cycle intervals
- 60 Hz – 12 cycle intervals
- 400 Hz – 50 cycle intervals
- VFD – Variable frequency drive (5 ÷ 110 Hz) – 5 cycle intervals

Connection check

Check if measurement results comply with given limits.



Connection check is marked with green OK sign (✓) if instrument is connected properly and measurement comply with given measurement setup.

Connection check is marked with yellow OK sign (✓), indicate that some measurements are at the edge of the measurement setup specification. This does not mean that something is necessary wrong, but require user attention to double check connection and instrument settings. Press F4 to check LIMITS.

Fail sign (✗) indicate that that instrument is connected incorrectly or measurement setup does not correspond with measured value. In this case it is necessary to readjust measurement settings, and check instrument connections.

By pressing ENTER key, detailed Connection check will be shown.

Connection: Consumed					11:13
	L1	L2	L3	N	
U	✓ 228.3	✓ 237.8	✓ 230.1	236.8	v
I	✓ 197.1	✓ 197.0	✓ 197.2	197.4	A
P	43.48	45.25	43.82		kW
Phase	✓ -15.0	✓ -15.0	✓ -15.0	-15.1	°
Useq	✓ 1 2 3		Ptot	132.5	kW
Iseq	✓ 1 2 3		f	✓ 49.996	Hz
DATE/TIME		VIEW		AUTOSET I	
				LIMITS	

See section 4.2.4 for details, how to use this menu.

F1

DATE/TIME

Set actual Date & Time and Time zone

F2

VIEW

Set Consumed or Generated view

F3

AUTOSET I

Set the auto check procedure for defining the optimal range of current clamps

F4

LIMITS





Predefined limits for the measurement result evaluation

LIMITS				11:39
U	90%–110% Un	207.0–253.0v		✓
I	5%–10% Iclamps	50.00–100.0A		✓
I	10%–110% Iclamps	100.0–1100A		✓
I	110%–150% Iclamps	1100–1500A		✓
f	85%–115% f	42.500–57.500Hz		✓
Phase	±90°			✓

Default parameters

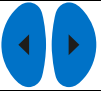
Set factory default parameters. These are:
 Nominal voltage: 230V (L-N);
 Voltage ratio: 1:1;
 $\Delta \leftrightarrow \blacktriangle$: 1
 Phase current clamps: Smart Clamps;
 Neutral current clamps: Smart Clamps;
 Connection: 4W;
 Synchronization: U1
 System frequency: 50 Hz.
 Dip voltage: 90% U_{Nom}
 Interrupt voltage: 5% U_{Nom}
 Swell voltage: 110% U_{Nom}
 Signalling frequency1: 316 Hz
 Signalling frequency2: 1060 Hz
 Signalling record duration: 10 sec
 Signalling threshold: 5% of nominal voltage
 RVC threshold: 3% of nominal voltage
 RVC hysteresis: 25%
 Measuring method: Modern (IEEE 1459)
 Clear Alarm setup table
 Record organisation: Folder
 Record starting time: Rounded
 Transient select: GND
 Waveform recorder setup: Event

Table 91: Keys in Connection setup menu

	Selects Connection setup parameter to be modified.
	Changes selected parameter value.
	Enters into submenu. Confirms Factory reset.
	Depends from Connection check status.
	
	For: <ul style="list-style-type: none"> OK sign (✓, ✓) Returns to the “MEASUREMENT SETUP” submenu. Fail sign (✗) enter into “CONNECTION CHECK” submenu. It is expected that user will resolve this issue before continuing with measurements. Press  again in order to leave “CONNECTION CHECK” menu.

3.21.2 Event setup

In this menu user can setup voltage events and their parameters. See 5.1.12 for further details regarding measurement methods. Captured events can be observed through EVENTS TABLE screen. See 3.17 and 5.1.12 for details.

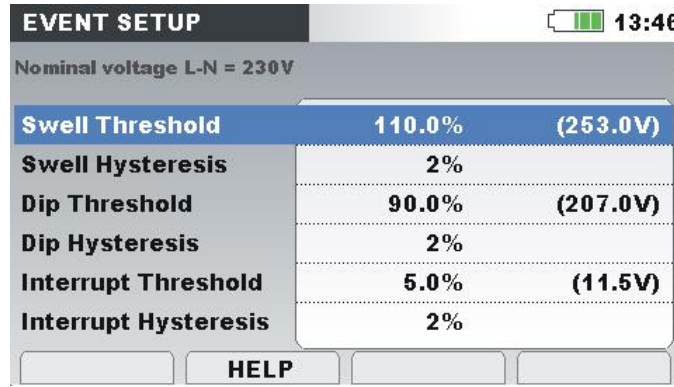



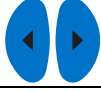

Figure 76: Event setup screen

Table 92: Description of Event setup

Nominal voltage	Indication of type (L-N or L-L) and value of nominal voltage.
Swell Threshold	Set swell threshold value in % of nominal voltage.
Swell Hysteresis	Set swell hysteresis value in % of nominal voltage.
Dip Threshold	Set dip threshold value in % of nominal voltage.
Dip Hysteresis	Set dip hysteresis value in in % of nominal voltage.
Interrupt Threshold	Set interrupt threshold value in % of nominal voltage.
Interrupt Hysteresis	Set interrupt hysteresis in % of nominal voltage.

Table 93: Keys in Event setup screen

<div style="background-color: #0070C0; color: white; padding: 5px; border-radius: 10px; display: inline-block;">F2</div>	<p>HELP</p>	<p>Shows help screens for Dip, Swell and Interrupt. See 5.1.13 for details.</p>															
<p>Keys in CHANNELS SETUP menu screen:</p> <table border="1"> <tr> <td style="text-align: center; vertical-align: middle;"> <div style="background-color: #0070C0; color: white; padding: 5px; border-radius: 10px; display: inline-block;">F1</div> </td> <td style="text-align: center; vertical-align: middle;">PREV</td> <td>Previous help screen</td> </tr> <tr> <td style="text-align: center; vertical-align: middle;"> <div style="background-color: #0070C0; color: white; padding: 5px; border-radius: 10px; display: inline-block;">F2</div> </td> <td style="text-align: center; vertical-align: middle;">NEXT</td> <td>Next help screen</td> </tr> <tr> <td style="text-align: center; vertical-align: middle;"> </td> <td></td> <td>Move between help screens.</td> </tr> <tr> <td style="text-align: center; vertical-align: middle;"> <div style="background-color: #D9534F; color: white; padding: 5px; border-radius: 10px; display: inline-block;">ENTER</div> </td> <td></td> <td>Move back to EVENT SETUP screen</td> </tr> <tr> <td style="text-align: center; vertical-align: middle;"> <div style="background-color: #333; color: white; padding: 5px; border-radius: 10px; display: inline-block;">ESC</div> </td> <td></td> <td></td> </tr> </table>			<div style="background-color: #0070C0; color: white; padding: 5px; border-radius: 10px; display: inline-block;">F1</div>	PREV	Previous help screen	<div style="background-color: #0070C0; color: white; padding: 5px; border-radius: 10px; display: inline-block;">F2</div>	NEXT	Next help screen			Move between help screens.	<div style="background-color: #D9534F; color: white; padding: 5px; border-radius: 10px; display: inline-block;">ENTER</div>		Move back to EVENT SETUP screen	<div style="background-color: #333; color: white; padding: 5px; border-radius: 10px; display: inline-block;">ESC</div>		
<div style="background-color: #0070C0; color: white; padding: 5px; border-radius: 10px; display: inline-block;">F1</div>	PREV	Previous help screen															
<div style="background-color: #0070C0; color: white; padding: 5px; border-radius: 10px; display: inline-block;">F2</div>	NEXT	Next help screen															
		Move between help screens.															
<div style="background-color: #D9534F; color: white; padding: 5px; border-radius: 10px; display: inline-block;">ENTER</div>		Move back to EVENT SETUP screen															
<div style="background-color: #333; color: white; padding: 5px; border-radius: 10px; display: inline-block;">ESC</div>																	

- 
Selects Voltage events setup. parameter to be modified
- 
Changes selected parameter value.
- 
Returns to the "MEASUREMENT SETUP" submenu.

3.21.3 Alarm setup

Up to 7 different alarms, based on any measurement quantity which is measured by instrument, can be defined. See 5.1.14 for further details regarding measurement methods. Captured events can be observed through ALARMS TABLE screens. See 3.18 and 5.1.14 for details.

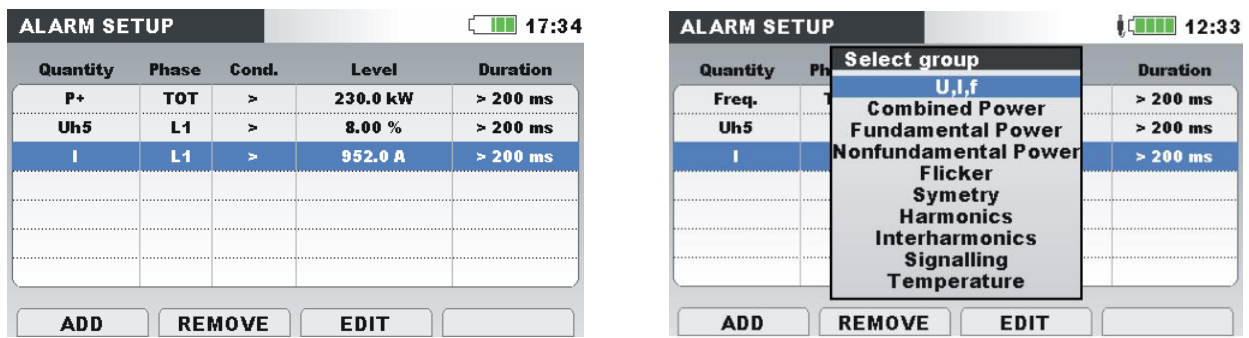









Figure 77: Alarm setup screens

Table 94: Description of Alarm setup

<p>1st column - Quantity (P+, Uh5, I, on figure above)</p>	<p>Select alarm from measurement group and then measurement itself.</p> <div style="display: flex; justify-content: space-around; align-items: center;"> <div style="border: 1px solid black; padding: 2px; text-align: center;"> Select group U,i,f Power Flicker Symetry Harmonics Interharmonics SIGNALLING Temperature </div> <div style="border: 1px solid black; padding: 2px; text-align: center;"> Select quantity Pstmin Pst Pit </div> </div>
<p>2nd column - Phase (TOT, L1, on figure above)</p>	<p>Select phases for alarms capturing</p> <ul style="list-style-type: none"> • L1 – alarms on phase L₁; • L2 – alarms on phase L₂; • L3 – alarms on phase L₃; • LN – alarms on phase N; • L12 – alarms on line L₁₂; • L23 – alarms on line L₂₃; • L31 – alarm on line L₃₁; • ALL – alarms on any phase; • TOT – alarms on power totals or non-phase measurements (frequency, unbalance).
<p>3rd column - Condition (“>” on figure above)</p>	<p>Select triggering method: < trigger when measured quantity is lower than threshold (FALL); > trigger when measured quantity is higher than threshold (RISE);</p>
<p>4th column -</p>	<p>Threshold value.</p>

Level	
5 th column - Duration	Minimal alarm duration. Triggers only if threshold is crossed for a defined period of time. Note: It is recommended that for flicker measurement, recorder is set to 10 min.

Table 95: Keys in Alarm setup screens

	ADD	Adds new alarm.
	REMOVE	Clears selected or all alarms: 
	EDIT	Edits selected alarm.
		Enters or exits a submenu to set an alarm.
		Cursor keys. Selects parameter or changes value.
		Cursor keys. Selects parameter or changes value.
		Confirms setting of an alarm. Returns to the "MEASUREMENT SETUP" submenu.

3.21.4 Signalling setup

Mains signalling voltage, called "ripple control signal" in certain applications, is a burst of signals, often applied at a non-harmonic frequency, that remotely control industrial equipment, revenue meters, and other devices.

Two different signalling frequencies can be defined. Signals can be used as a source for the user defined alarm and can also be included in recording. See section 3.21.3 for details how to set-up alarms. See section 3.14 for instructions how to start recording.

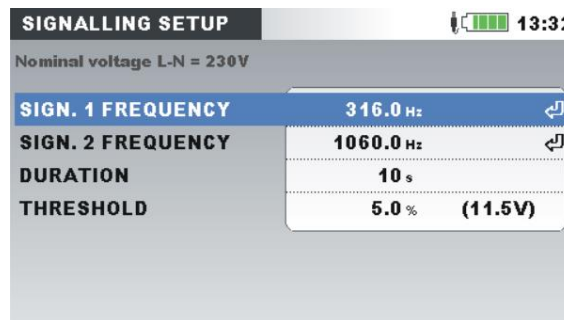





Figure 78: Signalling setup screen

Table 96: Description of Signalling setup

Nominal voltage	Indication of type (L-N or L-L) and value of nominal voltage.
------------------------	---

SIGN. 1 FREQUENCY	1 st observed signalling frequency.
SIGN. 2 FREQUENCY	2 nd observed signalling frequency.
DURATION	Duration of RMS record, which will be captured after treshold value is reached.
THRESHOLD	Threshold value expressed in % of nominal voltage, which will trigger recording of signalling event.

Table 97: Keys in Signalling setup screen

	Enters or exits a submenu to set signalling frequency.
	Toggles between given parameters.
	Changes selected parameter.
	Returns to the "MEASUREMENT SETUP" submenu.

3.21.5 Rapid voltage changes (RVC) setup

RVC is a quick transition in RMS voltage occurring between two steady-state conditions, and during which the RMS voltage does not exceed the dip/swell thresholds.

A voltage is in a steady-state condition if all the immediately preceding 100/120 $U_{Rms(\frac{1}{2})}$ values remain within a set RVC threshold from the arithmetic mean of those 100/120 $U_{Rms(\frac{1}{2})}$ (100 values for 50 Hz nominal and 120 values for 60 Hz). The RVC threshold is set by the user according to the application, as a percentage of U_{Nom} , within 1 ÷ 6 %. See section 5.1.15 for details regarding RVC measurement. See section 3.14 for instructions how to start recording.

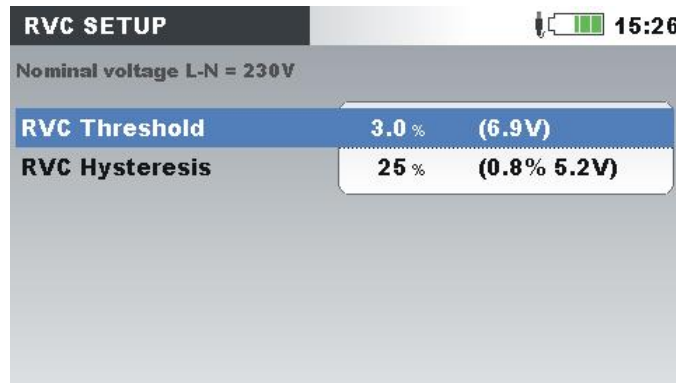





Figure 79: RVC setup screen

Table 98: Description of RVC setup

Nominal voltage	Indication of type (L-N or L-L) and value of nominal voltage.
RVC THRESHOLD	RVC threshold value expressed in % of nominal voltage for steady state voltage detection.
RVC HYSTERESIS	RVC hysteresis value expressed in % of RVC threshold.

Table 99: Keys in RVC setup screen

	Toggles between given parameters.
	Changes selected parameter.
	Returns to the "MEASUREMENT SETUP" submenu.

3.21.6 Measuring Methods setup

In this menu different measurement methods, file structure on the SD card, type of recording start time and transient selection can be selected, according to the local standards and practice. See section 5.1.5 for Modern Power measurement and 5.1.6 for Classic Vector and Arithmetic Power measurement details. Please note that instrument record all measurement (Classic and Modern), regardless of selected method.

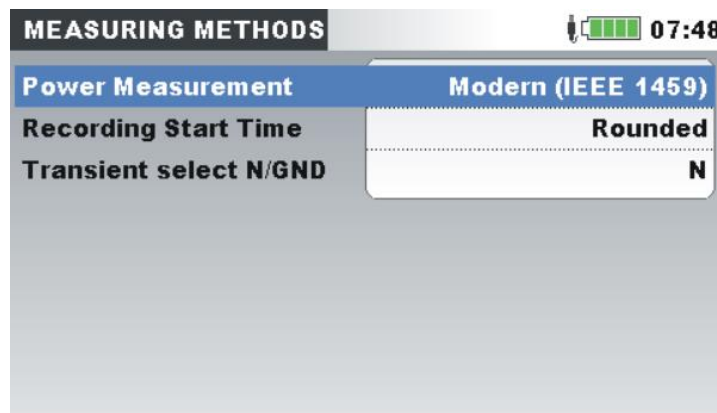





Figure 80: Measuring Methods setup screen

Table 100: Description of Measuring Methods setup

Power Measurements	<p>Modern (IEEE 1459) measuring method. See section 5.1.5 for details.</p> <p>Classic (Vector) measuring method. See section 5.1.6 for details.</p> <p>Classic (Arithmetic) measuring method. See section 5.1.6 for details.</p>
Record Start Time	<p>Selection Recorder Start Time:</p> <ul style="list-style-type: none"> • Rounded – recorder start is postponed and synchronized with the clock (integer periods in one-hour period) • Immediately – recorder starts on the next minute
Transient select N/GND	Transient selection measurement between Phase - Neutral or Phase - Ground

Table 101: Keys in Measuring Methods setup screen

	Toggles between given parameters.
	Changes selected parameter.
	Returns to the "MEASUREMENT SETUP" submenu.

3.21.7 Transient setup

In this menu parameters for transient trigger could be selected. It is possible to select trigger for:

- Phase voltage,
- Phase current,
- Neutral voltage,
- Neutral current.

Two different type of trigger could be defined:

- Selection to the voltage/current level,
- Envelope.

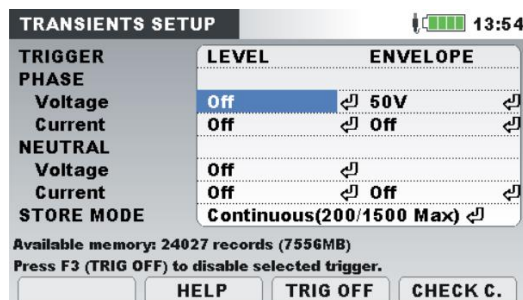
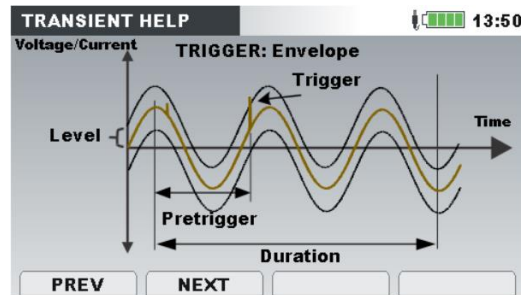

Figure 81: Transient setup screen

Table 102: Description of Transient setup

Help

Show triggering help screens. See 5.1.20 for details.



TRIG OFF

Deleting the trigger selection.

CHECK C.

Check connection settings. See 3.21.1 for details.

3.22 General Setup submenu

From the "GENERAL SETUP" submenu communication parameters, real clock time, language, lock/unlock and colour model can be reviewed, configured and saved.

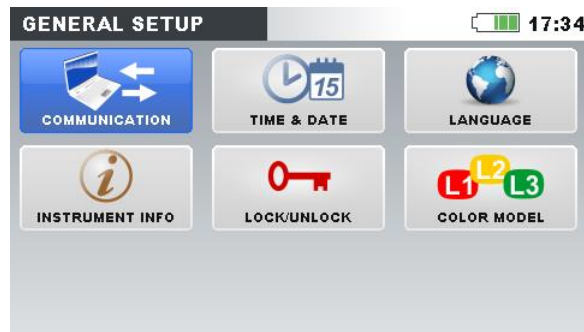
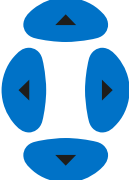



Figure 82: GENERAL SETUP submenu

Table 103: Description of General setup options

Communication	Setup communication source.
Time & Date	Set time, date and time zone.
Language	Select language.
Instrument info	Information about the instrument.
Lock/Unlock	Lock instrument to prevent unauthorized access.
Colour Model	Select colours for displaying phase measurements.

Table 104: Keys in General setup submenu

	Selects option from the “GENERAL SETUP” submenu.
	Enters the selected option.
	Returns to the “MAIN MENU” screen.

3.22.1 Communication

In this menu user can select instrument communication interface. There are four possibilities:

- USB communication. Instrument is connected to PC by USB communication cable
- INTERNET communication. Instrument is connected to the internet, through local area network (Ethernet LAN). PowerView access to the instrument is made over internet and Metrel GPRS Relay server. See section 4.3 for details.
- INTERNET (3G, GPRS). Instrument is connected to the internet over 3G or GPRS. This option minimises internet 3G traffic with Metrel GPRS Relay server and PowerView, in order to reduce link cost. Instrument in idle state (while not connected to the PowerView) consume about 5MB/per day. See section 4.3 for details.
- INTERNET (LAN). Instrument is connected to the internet, through local area network (Ethernet LAN). IP address, Net mask, Primary DNS, Secondary DNS and Gateway are defined manually (DHCP disabled) or automatically (DHCP enabled). Port number should be defined manually. PowerView access to the instrument is made over internet. See section 4.3 for details.

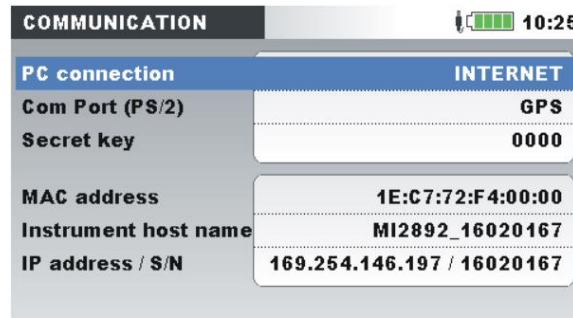
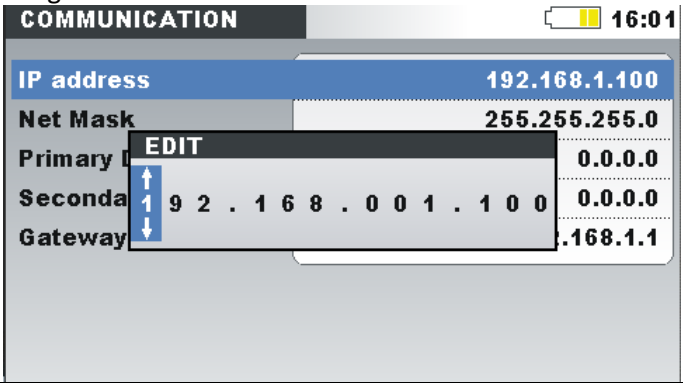



Figure 83: Communication setup screen



Table 105: Description of Communication setup options

PC connection	Select USB or INTERNET, INTERNET (3G / GPRS), INTRANET (LAN) communication port.
Com Port (PS/2)	Select GPS or MI 3108 / MI 3109 communication. GPS is used for A 1355 GPS receiver, and MI 3108 / MI 3109 for photovoltaics inverter measurements (See MI 3108/ MI 3109 User manual).
Modem used in A 1565	Select this option if A 1622 WiFi / 3G modem is used within A 1565 Waterproof case for outdoor application and recordings
DHCP	Select Enabled in order to enable automatic network parameters assignment. Select Disabled in order to enter them manually. 
Secret key	Valid only if INTERNET communication is selected. Secret number will assure additional protection of communication link. Same number should be entered in PowerView v3.0, before connection establishment.
MAC address	Instrument Ethernet MAC address.
Instrument host name	Instrument host name.
Instrument IP address	Instrument IP address.

Note: For more information regarding configuration, how to download data, view real time measuring data on PowerView and establish Remote instrument connection with PowerView over internet and USB communication interfaces, see section 4.3 and PowerView Instruction manual.

Table 106: Keys in Communication setup

	Changes communication source: USB, INTERNET, INTERNET (3G, GPRS)
	Moves cursor position during entering Secret key.

	Cursor keys. Selects parameter. Changes Secret key number.
	Enters Secret key edit window.
	Returns to the "GENERAL SETUP" submenu.



3.22.2 Time & Date

Time, date and time zone can be set in this menu.

3.22.3 Time & Date

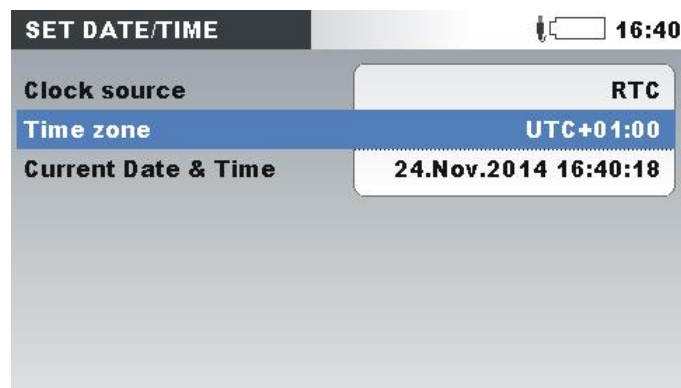





Figure 84: Set date/time screen

Table 107: Description of Set date/time screen

Clock source	Show clock source: RTC – internal real time clock GPS – external GPS receiver Note: GPS clock source is automatically set if GPS is enabled and detected.
Time zone	Selects time zone. Note: Power Master XT has the ability to synchronize its system time clock with Coordinated Universal Time (UTC time) provided by externally connected GPS module. In that case only time zone (in 15 min intervals) can be adjusted. In order to use this functionality, see 4.2.6.
Current Time & Date	Show/edit current time and date (valid only if RTC is used as time source)



Table 108: Keys in Set date/time screen

	Selects parameter to be changed.
	Modifies parameter. Selects between the following parameters: hour, minute, second, day, month or year.
	Enters Date/time edit window.
	Returns to the "GENERAL SETUP" submenu.

3.22.4 Language

Different languages can be selected in this menu.

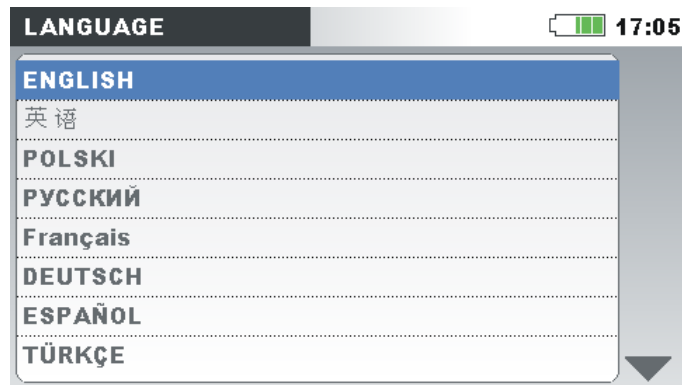





Figure 85: Language setup screen

Table 109: Keys in Language setup screen

	Selects language.
	Confirms the selected language.
	Returns to the "GENERAL SETUP" submenu.

3.22.5 Instrument info

Basic information concerning the instrument (company, user data, serial number, firmware and hardware version, transient module firmware, hardware version and instrument calibration date) can be viewed in this menu.

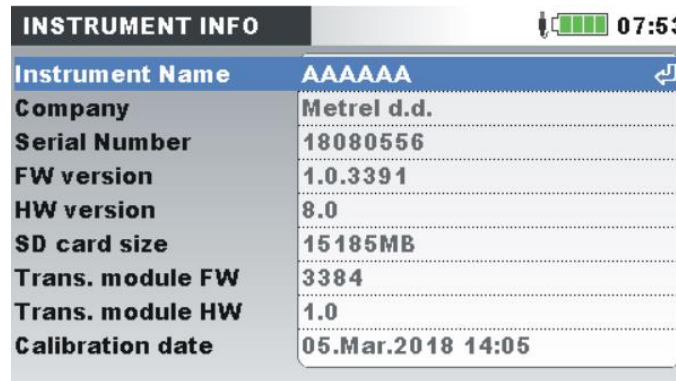

Figure 86: Instrument info screen

Table 110: Keys in Instrument info screen

ESC	Returns to the "GENERAL SETUP" submenu.
------------	---

3.22.6 Lock/Unlock

Power Master XT has the ability to prevent unauthorized access to all important instrument functionality by simply locking the instrument. If instrument is left for a longer period at an unsupervised measurement spot, it is recommended to prevent unintentional stopping of record, instrument or measurement setup modifications, etc. Although instrument lock prevents unauthorized changing of instrument working mode, it does not prevent non-destructive operations as displaying current measurement values or trends.

User locks the instrument by entering secret lock code in the Lock/Unlock screen.

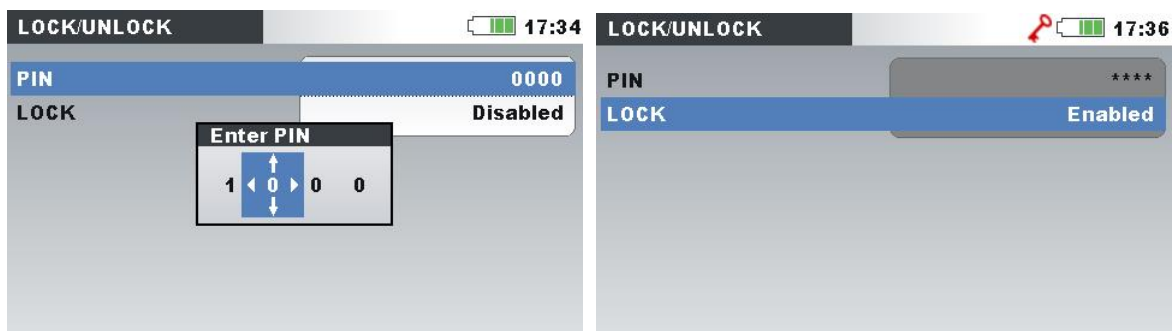

Figure 87: Lock/Unlock screen

Table 111: Description of Lock/Unlock screen

Pin	Four-digit numeric code used for Locking/Unlocking the instrument. Press ENTER key for changing the Pin code. "Enter PIN" window will appear on screen.
------------	---





Note: Pin code is hidden (****), if the instrument is locked.

The following options for locking the instrument are available:

Lock

- Disabled
- Enabled

Table 112: Keys in Lock/Unlock screen

	Selects parameter to be modified.
	Change value of the selected digit in Enter pin window.
	Selects digit in Enter pin window. Locks the instrument. Opens Enter pin window for unlocking.
	Opens Enter pin window for pin modification. Accepts new pin. Unlocks the instrument (if pin code is correct).
	Returns to the "GENERAL SETUP" submenu.

Following table shows how locking impacts instrument functionality.

Table 113: Locked instrument functionality

MEASUREMENTS	Allowed access. Waveform snapshot functionality is blocked.
RECORDERS	No access.
MEASUREMENT SETUP	No access.
GENERAL SETUP	No access except to Lock/Unlock menu.

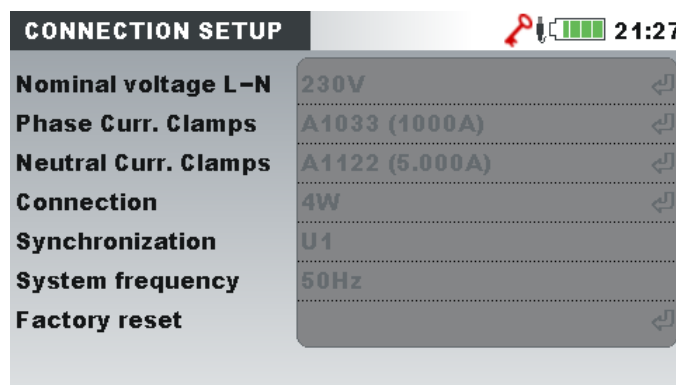

Figure 88: Locked instrument screen

Note: In case user forget unlock code, general unlock code "7350" can be used to unlock the instrument.

3.22.7 Colour model

In COLOUR MODEL menu, user can change colour representation of phase voltages and currents, according to the customer needs. There are some predefined colour schemes (EU, USA, etc.) and a custom mode where user can set up its own colour model.

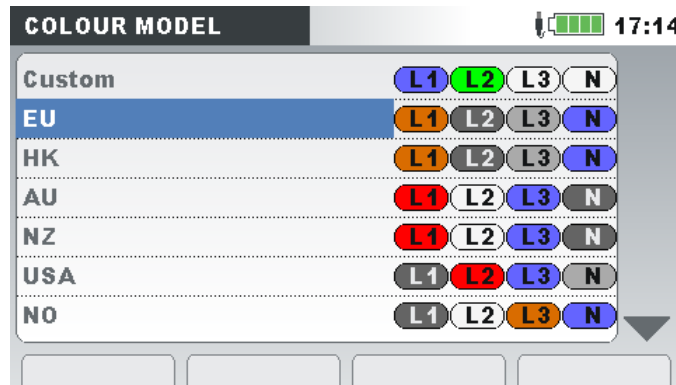
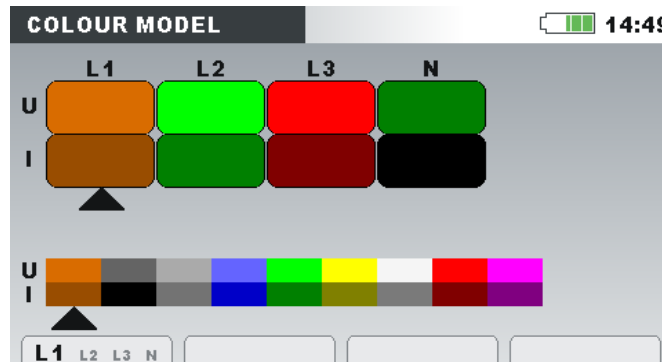

Figure 89: Colour representation of phase voltages

Table 114: Keys in Colour model screens

Opens edit colour screen (only available in custom model).



Keys in Edit colour screen:

L1 L2 L3 N	Shows selected colour for phase L1.
F1 L1 L2 L3 N	Shows selected colour for phase L2.
L1 L2 L3 N	Shows selected colour for phase L3.
L1 L2 L3 N	Shows selected colour for neutral channel N.
	Selects colour.
ENTER	Returns to the "COLOUR MODEL" screen.
ESC	



Selects Colour scheme.



Confirms selection of Colour scheme and returns to the "GENERAL SETUP" submenu.



Returns to the "GENERAL SETUP" submenu without modifications.

4 Recording Practice and Instrument Connection

In following section recommended measurement and recording practice is described.

4.1 Measurement campaign

Power quality measurements are specific type of measurements, which can last many days, and mostly they are *performed* only once. Usually recording campaign is performed to:

- Statistically analyse some points in the network.
- Troubleshoot malfunctioning device or machine.

Since measurements are mostly *performed* only once, it is very important to properly set measuring equipment. Measuring with wrong settings can lead to false or useless measurement results. Therefore, instrument and user should be fully prepared before measurement begins.

In this section recommended recorder procedure is shown. We recommend to strictly follow guidelines in order to avoid common problems and measurement mistakes. Figure below shortly summarizes recommended measurement practice. Each step is then described in details.

Note: PC software PowerView v3.0 has the ability to correct (after measurement is done):

- wrong real-time settings,
- wrong current and voltage scaling factors,
- voltage unbalance.

False instrument connection (messed wiring, opposite clamp direction), can't be fixed afterwards.

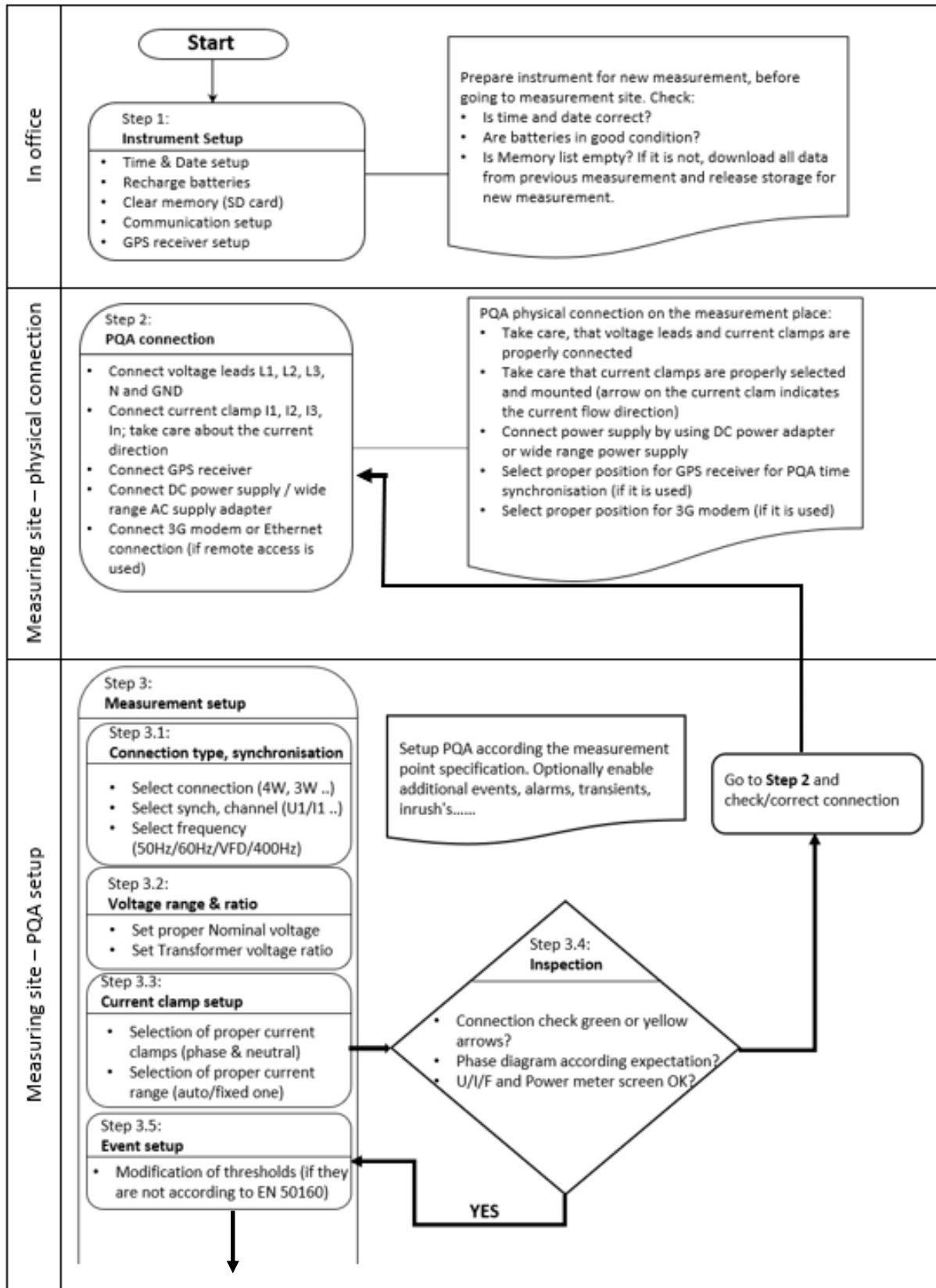

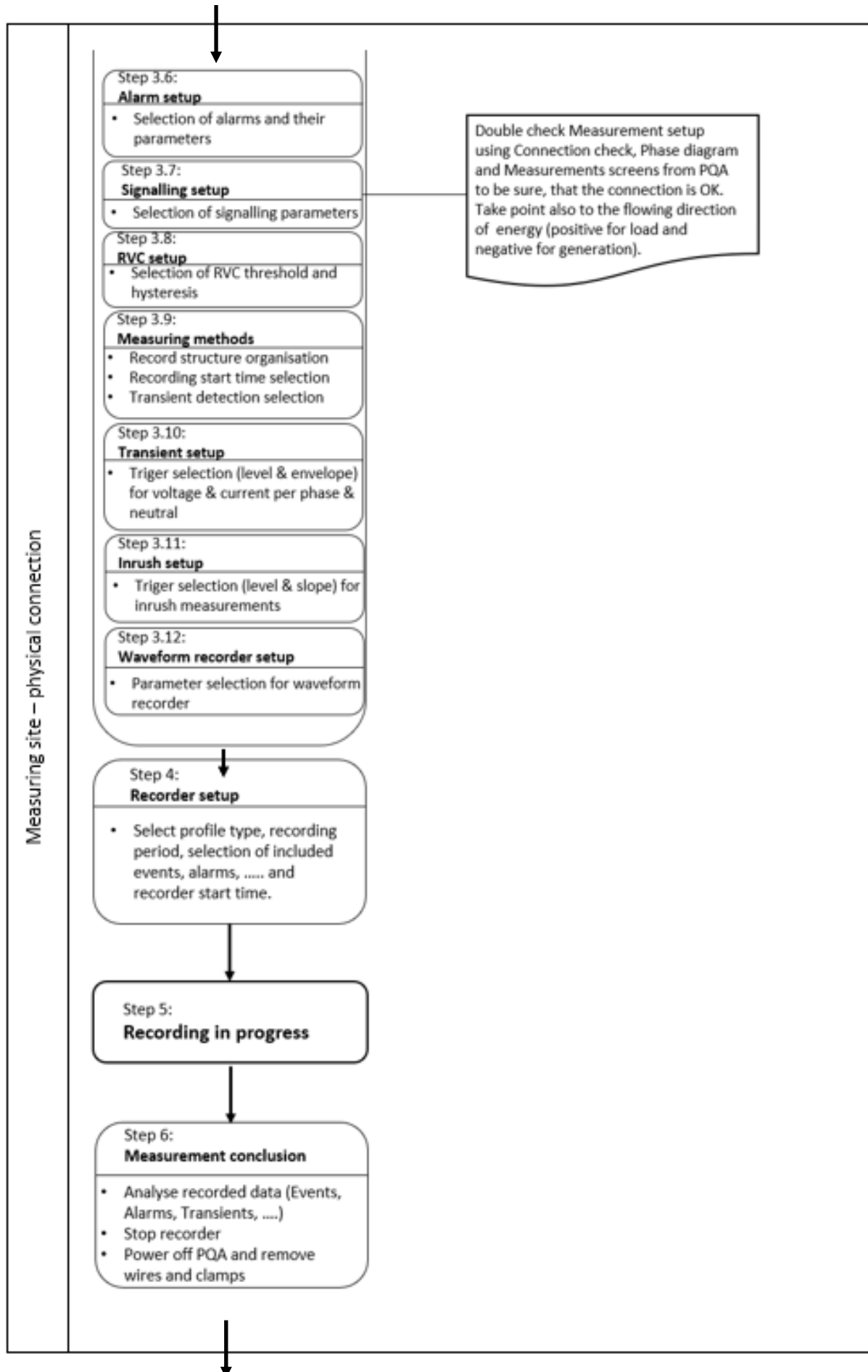

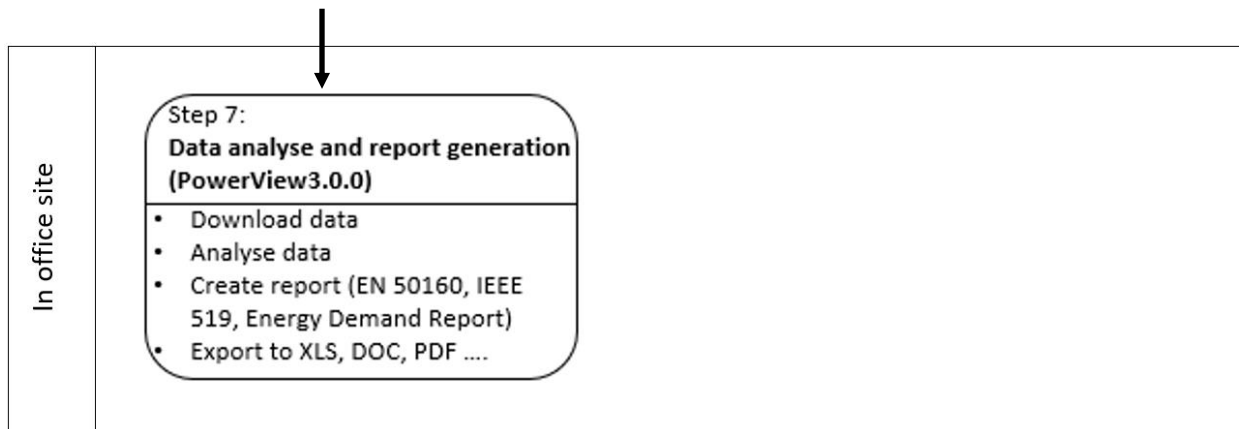

Figure 4.1.1: Recommended measurement practice

Step 1: Instrument setup

On site measurements can be very stressful, and therefore it is good practice to prepare measurement equipment in an office. Preparation of Power Master XT include following steps:

- Visually check instrument and accessories.
Warning: Don't use visually damaged equipment!
- Always use batteries that are in good condition and fully charge them before you leave an office.
Note: In problematic PQ environment where dips and interrupts frequently occur instrument power supply fully depends on batteries! Keep your batteries in good condition.
- Download all previous records from instrument and clear the memory. (See section 3.19 for instruction regarding memory clearing).
- Set instrument time and date. (See section 3.22.2 for instruction regarding time and date settings).

Step 2: PQA connection

Take care for the proper connection of voltage leads and current clamps (current direction). Voltage and current sequence should be correct to fulfil the requirements from the power quality standard positive sequence, load or generation measurement). In case, that GPS receiver is used for accurate time synchronisation, connect in in the proper place to enable good signal receiving.

Step 3: Measurement setup

Measurement setup adjustment is *performed* on measured site, after we find out details regarding nominal voltage, currents, type of wiring etc.

Step 3.1: Connection type, synchronisation

- Connect current clamps and voltage tips according to the "Device under measurement" (See section 4.2 for details).
- Select proper type of connection in "Connection setup" menu (See section 3.21.1 for details).
- Select synchronization channel. Synchronization to voltage is recommended, unless measurement is performed on highly distorted loads, such as PWM drives. In that case current synchronization can be more appropriate. (See section 3.21.1 for details).
- Select System frequency. System frequency is default mains system frequency. Setting this parameter is recommended if to measure signalling or flickers.

Step 3.2: Nominal voltage and ratio

- Select instrument nominal voltage according to the network nominal voltage.
Note: For 4W and 1W measurement all voltages are specified as phase-to-neutral (L-N). For 3W and Open Delta measurements all voltages are specified as phase-to-phase (L-L).
Note: Instrument assures proper measurement up to 150 % of chosen nominal voltage.
- In case of indirect voltage measurement, select appropriate “Voltage ratio” parameters, according to transformer ratio. (See section 3.21.1 and 4.2.2 for details).

Step 3.3: Current clamps setup

- Using “Select Clamps” menu, select proper Phase and Neutral channel current clamps (see sections 3.21.1 for details).
- Select proper clamps parameters (measuring range: automatic or fixed one) according to the type of connection (see section 4.2.3 for details).

Step 3.4: Inspection

After setup instrument and measurement is finished, user need to re-check if everything is connected and configured properly. Following steps are recommended:

- Using PHASE DIAGRAM menu check if voltage and current phase sequence is right regarding to the system. Additionally, check if current has right direction.
- Using U, I, f menu check if voltage and current have proper values.
- Check voltage and current THD.

Note: Excessive THD can indicate that too small range was chosen!

Note: In case of AD converter overvoltage or overloading current, icon  will be displayed.

- Using POWER menu check signs and indices of active, nonactive, apparent power and power factor.

If any of these steps give you suspicious measurement results, return to Step 2 and double check measurement setup parameters.

Step 3.5: Event setup

Select threshold values for: swell, dip and interrupts (see sections 3.21.2 and 3.17 for details).

Note: You can also trigger WAVEFORM RECORDER on events. Instrument will then capture waveform and inrush for each event.

Step 3.6: Alarm setup

Use this step if you would like only to check if some quantities cross some predefined boundaries (see sections 3.18 and 3.21.3 for details).

Note: You can also trigger WAVEFORM RECORDER on alarms. Instrument will then capture waveform and inrush for each alarm.

Step 3.7: Signalling setup

Use this step only if you are interested in measuring mains signalling voltage. See section 3.21.4 for details.

Step 3.8: RVC setup

Use this step if you are interested in detection of rapid voltage changes (RVC). See section 3.21.4 for details.

Step 3.9: Measuring methods

Select parameters related to the data structure organisation on the SD card, type of recorder starts time and transient selection. See section 3.21.4 for details.

Step 3.10: Transient setup

Select parameters for defining triggers for capturing the transients, separate for voltage and currents. See section 3.21.4 for details.

Step 3.11: Inrush setup

Select parameters for defining trigger for capturing the inrush current. See section 3.21.4 for details.

Step 3.12: Waveform recorder setup

Select parameters for defining trigger for waveform recorder. See section 3.21.4 for details.

Step 4: Recorder setup and recording

Using GENERAL RECORDER menu select type of recording and configure recording parameters such as:

- Time for data aggregation (Integration Period)
- Include events, alarms, ... capture if necessary. Waveforms will be automatically captured for selected options.
- Recording start time (optional)
- After setting recorder, recording can be started. (see section 3.14 for recorder details).

Note: Available memory status in Recorder setup should be checked before starting recording. Max. recording duration and max. number of records are automatically calculated according to recorder setup and memory size.

Note: Recording usually takes several days. Assure that instrument during recording session is not reachable to the unauthorized persons. If necessary, use LOCK functionality described in section 3.22.6.

Note: If during record session instrument batteries are drained, due to long interruption for example, instrument will shut down. After electricity comes back, instrument will automatically start new recording session.

Step 5: Recording in progress

Press START button to start recording with all simultaneous registration of included network events.

Step 6: Measurement conclusion

Before leaving measurement site we need to:

- Preliminary evaluate recorded data using TREND screens.
- Stop recorder.
- Assure that we record and measure everything we needed.

Step 7: Data analyse and report generation (PowerView v3.0)

Download records using PC software PowerView v3.0 perform analysis and create reports. See PowerView v3.0 manual for details.

4.2 Connection setup

4.2.1 Connection to the LV Power Systems

This instrument can be connected to different type of networks. Proper connection should be selected to obtain the reliable results.

The actual connection scheme has to be defined in CONNECTION SETUP menu (see Figure below).

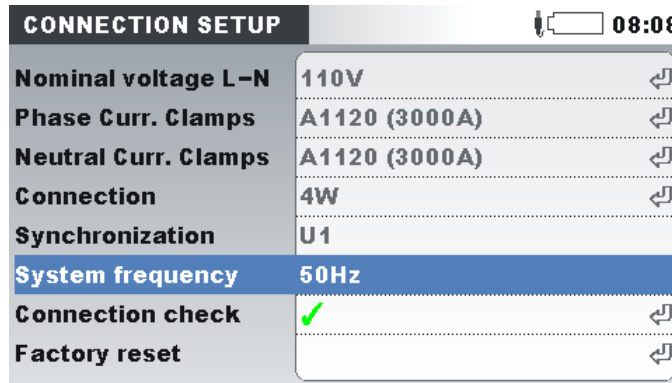

Figure 2: Connection setup menu

When connecting the instrument, it is essential that both current and voltage connections are correct. In particular the following rules have to be observed:

Clamp-on current clamp-on transformers

- The arrow marked on the clamp-on current transformer should point in the direction of current flow, from supply to load.
- If the clamp-on current transformer is connected in reverse the measured power in that phase would normally appear negative.

Phase relationships

- The clamp-on current transformer connected to current input connector I₁ has to measure the current in the phase line to which the voltage probe from L₁ is connected.

3-phase 4-wire system (4W)

In order to select this connection scheme, choose following connection on the instrument:

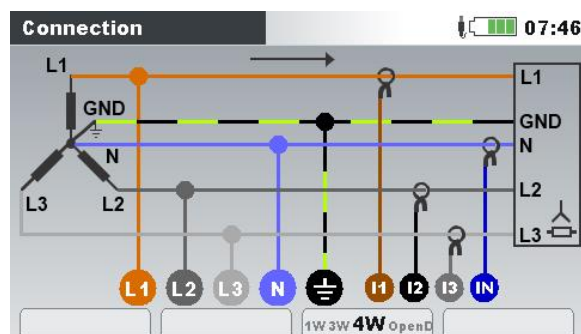

Figure 3: Choosing 3-phase 4-wire system on instrument

Instrument should be connected to the network according to figure below:

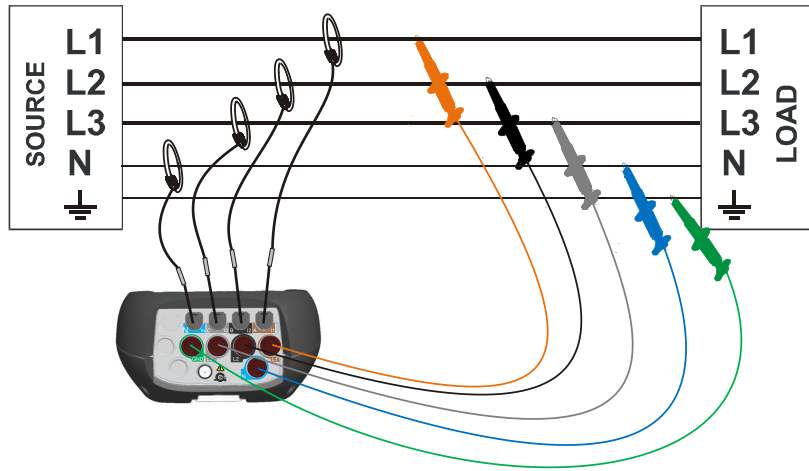

Figure 4: 3-phase 4-wire system

3-phase 3-wire system (3W)

In order to select this connection scheme, choose following connection on the instrument:

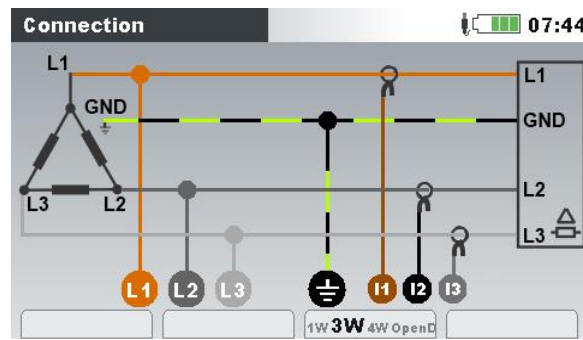

Figure 5: Choosing 3-phase 3-wire system on instrument

Instrument should be connected to the network according to figure below.

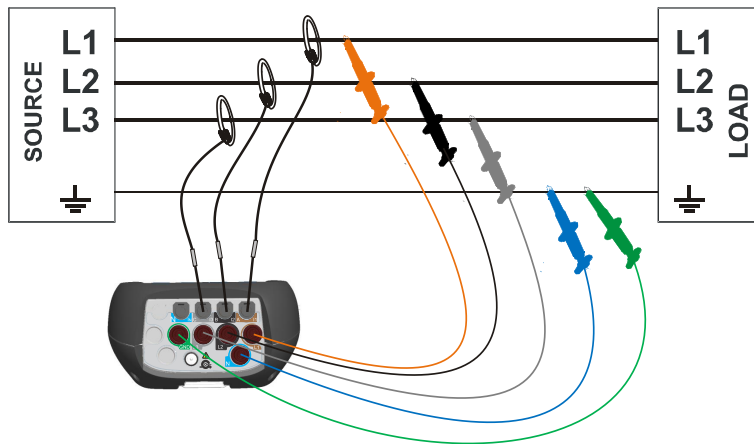

Figure 6: 3-phase 3-wire system

Open Delta (Aaron) 3-wire system (OpenD)

In order to select this connection scheme, choose following connection on the instrument:

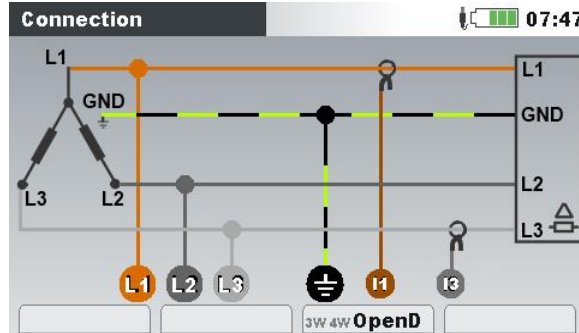

Figure 7: Choosing Open Delta (Aaron) 3-wire system on instrument

Instrument should be connected to the network according to figure below.

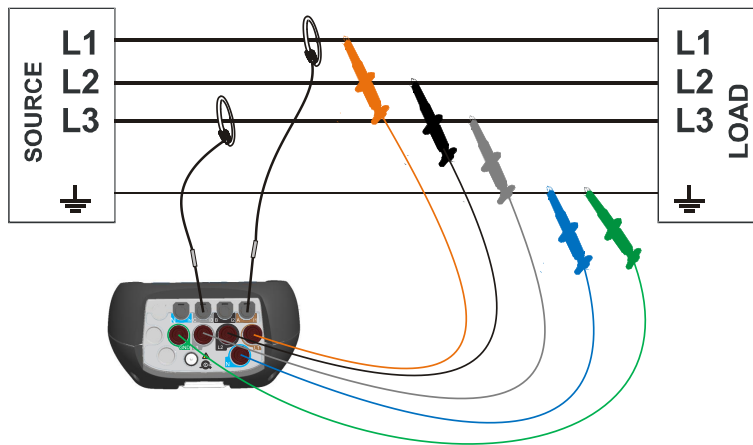

Figure 8: Open Delta (Aaron) 3-wire system

1-phase 3-wire system (1W)

In order to select this connection scheme, choose following connection on the instrument:

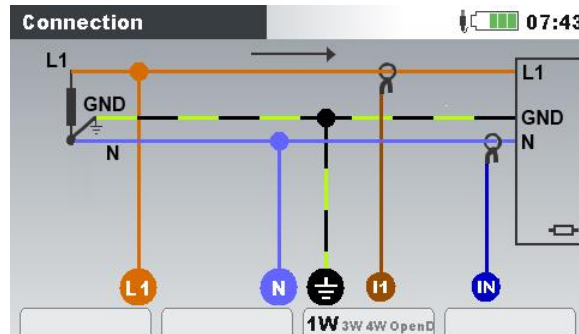

Figure 9: Choosing 1-phase 3-wire system on instrument

Instrument should be connected to the network according to figure below.

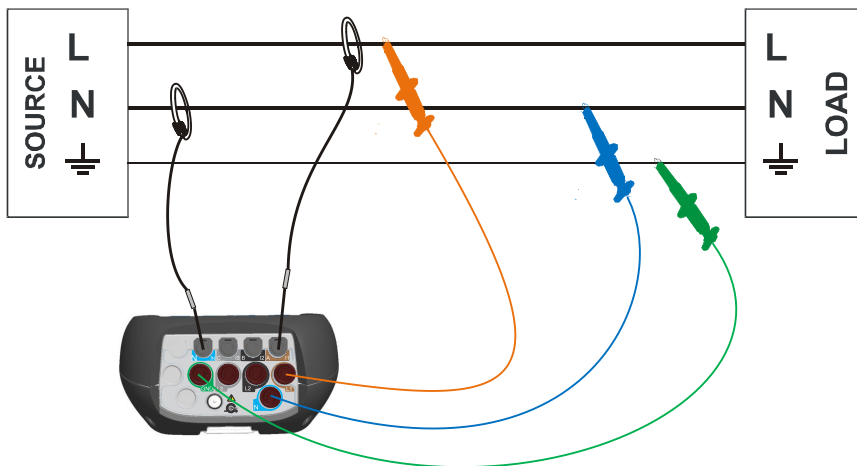

Figure 10: 1-phase 3-wire system

Note: In case of events capturing, it is recommended to connect unused voltage terminals to N voltage terminal.

2-phase 4-wire system (2W)

In order to select this connection scheme, choose following connection on the instrument:

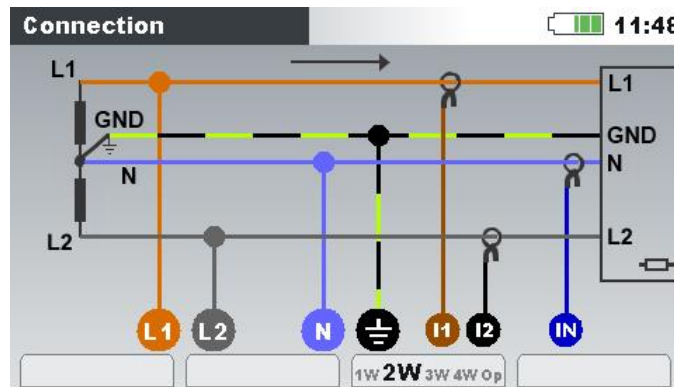

Figure 11: Choosing 2-phase 4-wire system on instrument

Instrument should be connected to the network according to figure below.

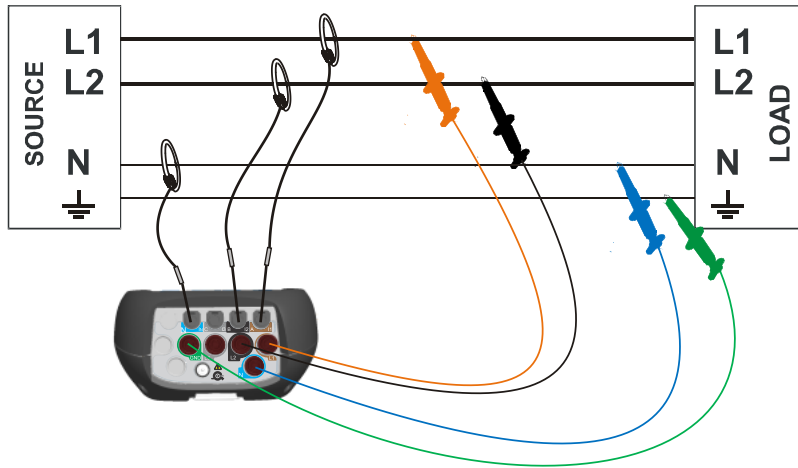

Figure 12: 2-phase 4-wire system

Note: In case of events capturing, it is recommended to connect unused voltage terminal to N voltage terminal.

Single - phase Inverter (INV1W)

In order to select this connection scheme, choose following connection on the instrument:

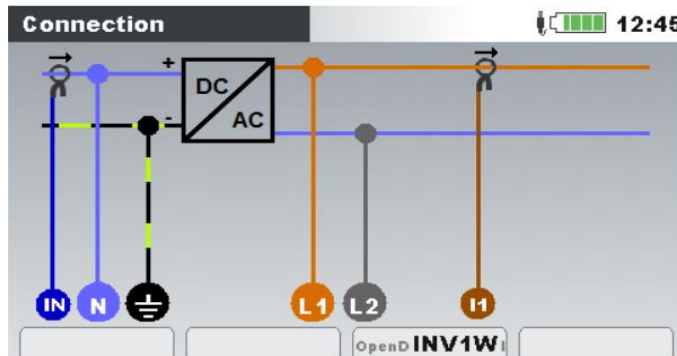

Figure 13: Choosing single- phase Inverter system on instrument

Instrument should be connected to the network according to figure below.

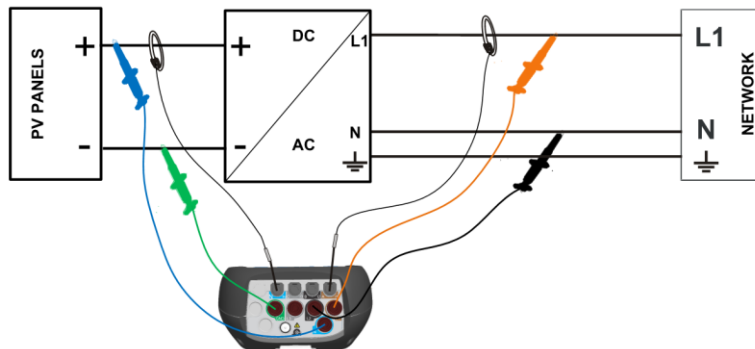

Figure 14: Single – phase inverter system

Note: In case of events capturing, it is recommended to connect unused voltage terminal to N voltage terminal.

Three - phase photovoltaic Inverter (INV3W)

In order to select this connection scheme, choose following connection on the instrument:

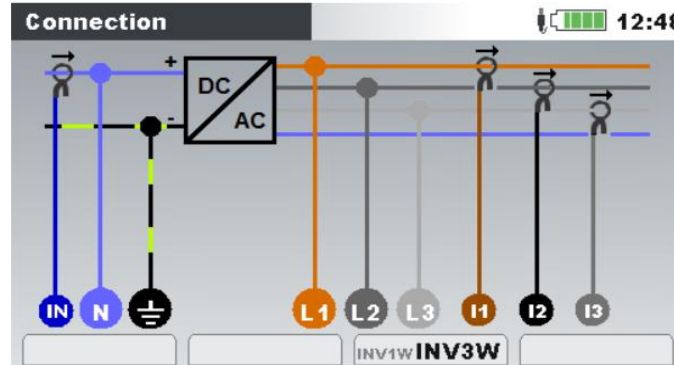

Figure 15: Choosing three- phase Inverter system on instrument

Instrument should be connected to the network according to figure below.

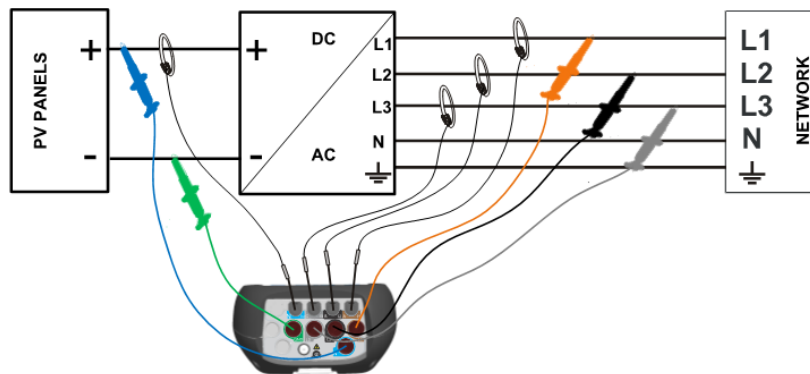

Figure 16: Three – phase inverter system

4.2.2 Connection to the MV or HV Power System

In systems where voltage is measured at the secondary side of a voltage transformer (for example: 11 kV / 110 V), the voltage transformer ratio should be entered. Afterward nominal voltage can be set to ensure correct measurement. In the next figure settings for this particular example is shown. See 3.21.1 for details.

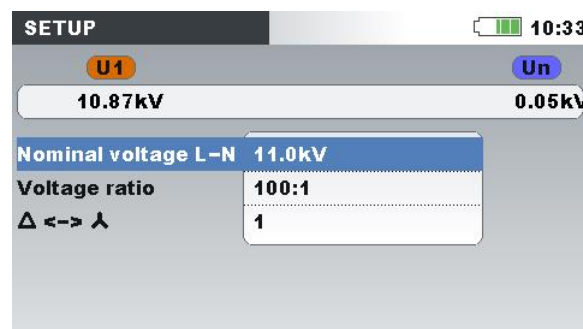

Figure 17: Voltage ratio for 11 kV / 110 kV transformer example

Instrument should be connected to the network according to figure below.

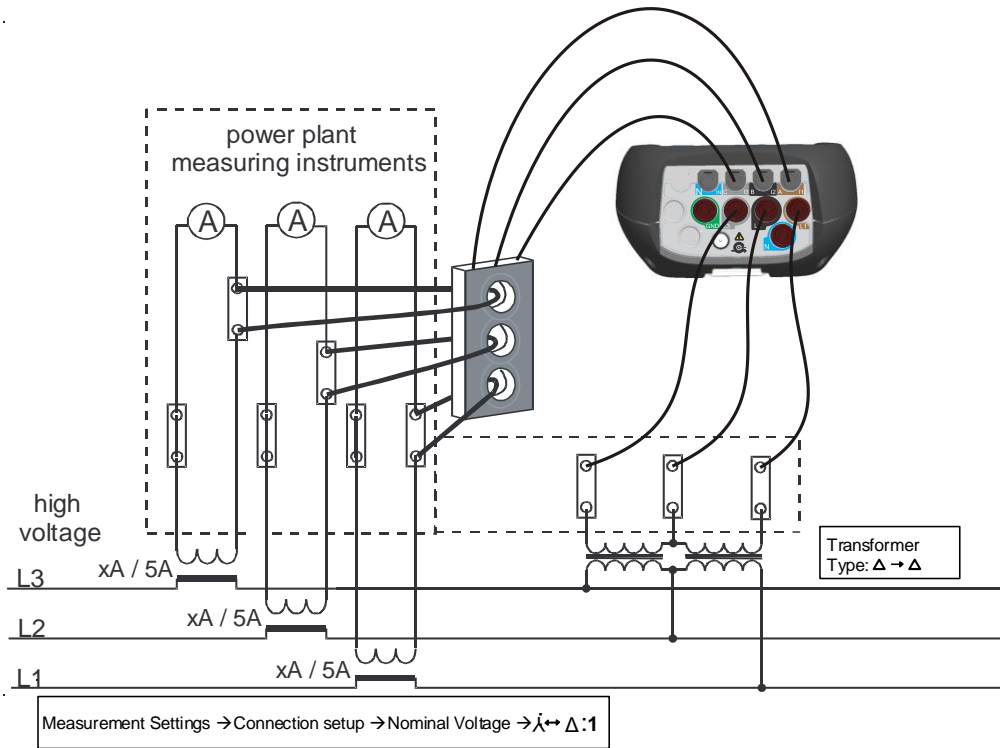

Figure 18: Connecting instrument to the existing current transformers in medium voltage system (Aaron / OpenDelta)

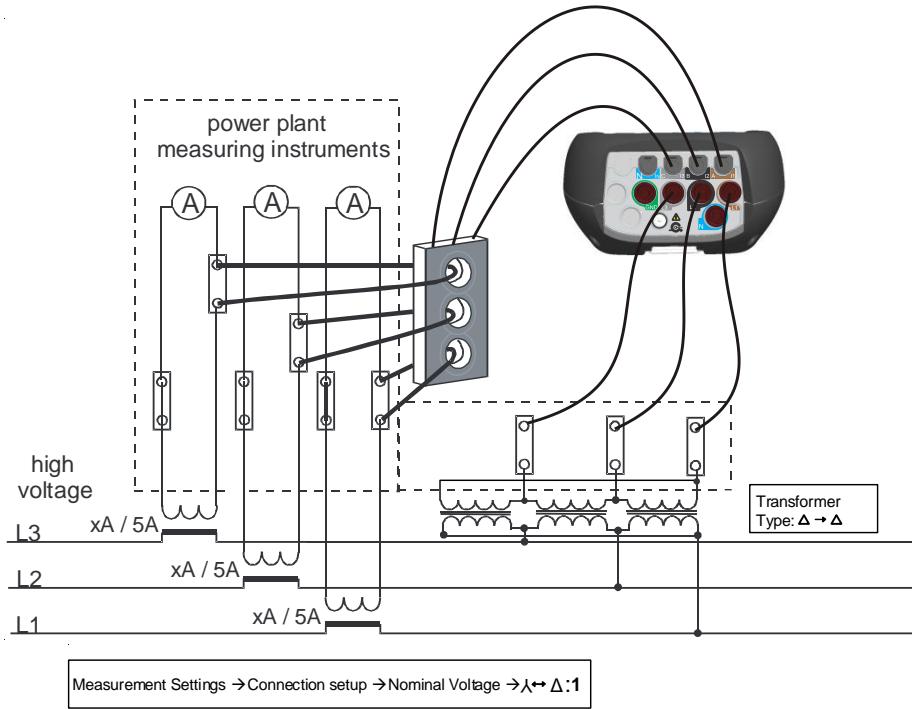

Figure 19: Connecting instrument to the existing current transformers in medium voltage system (Delta – Delta)

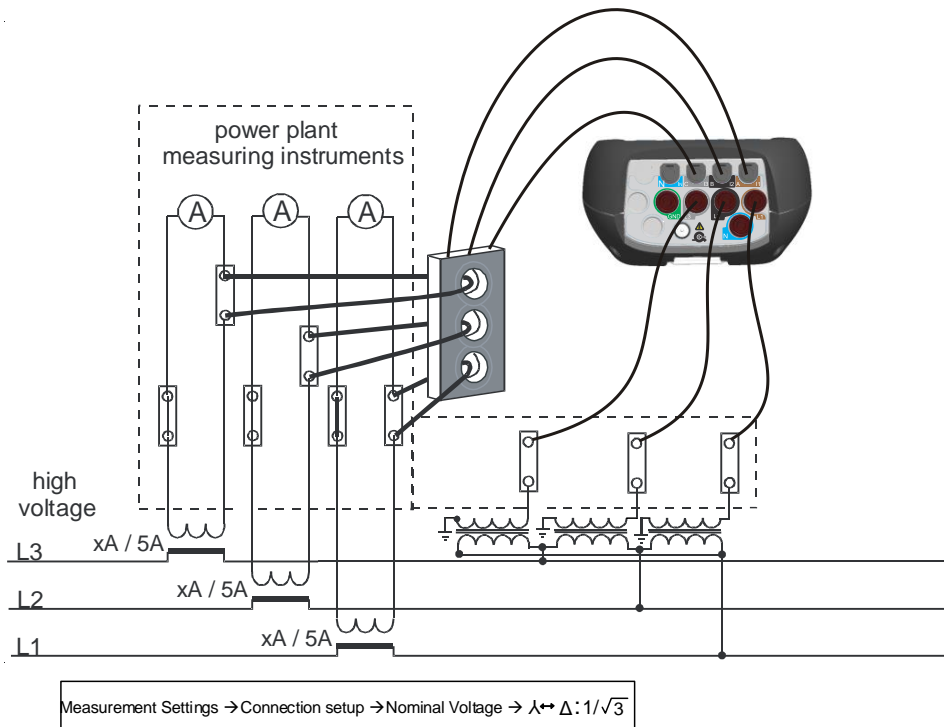

Figure 20: Connecting instrument to the existing current transformers in medium voltage system (Delta – Star)

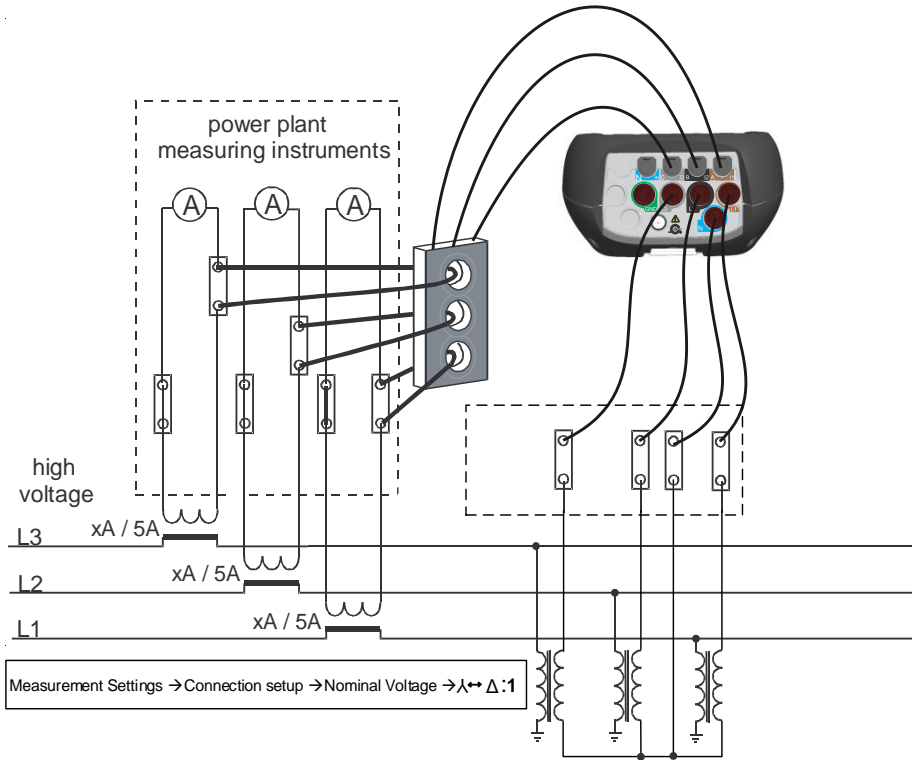

Figure 21: Connecting instrument to the existing current transformers in medium voltage system (Star – Star)

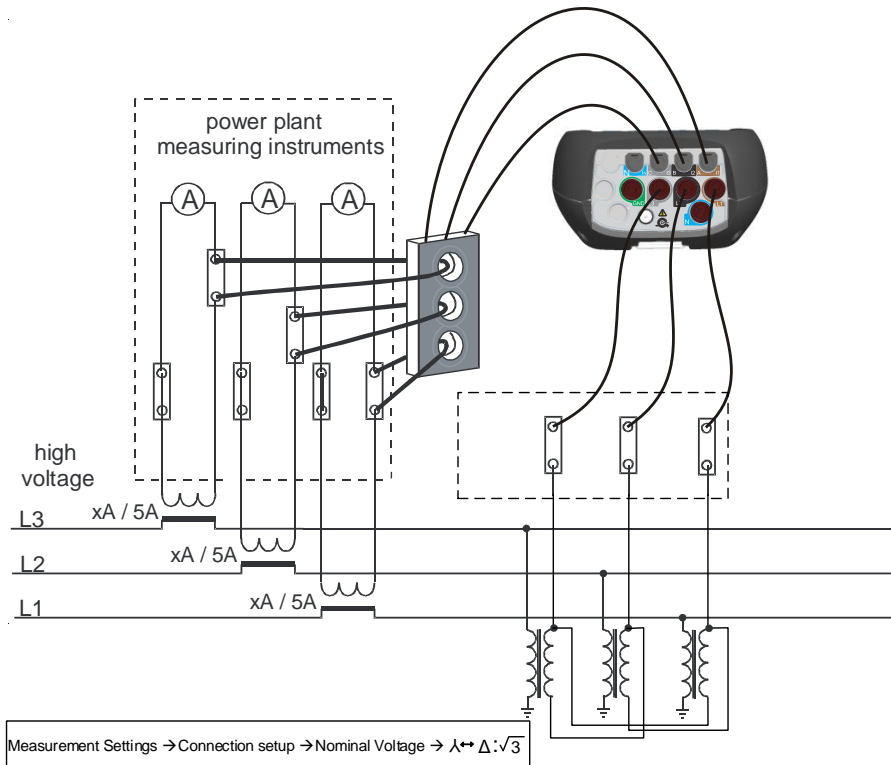

Figure 22: Connecting instrument to the existing current transformers in medium voltage system (star – delta)

4.2.3 Current clamp selection and transformation ratio setting

Clamp selection can be explained by two typical use cases: **direct current measurement** and **indirect current measurement**. In next section recommended practice for both cases is shown.

Auto range current clamp operation

Most of Metrel current clamps are developed as Smart clamps. They are automatically recognised by the instrument. Most of clamps support more different current ranges, for example 30/300/3000 A. MI 2893 could operate in so called “**Auto**” range, where instrument automatically select the most optimal current clamp range. In this case, the most accurate current measurements are guaranteed.

Note 1: In case of “auto range” selection, Inrush measurements are not reliable.

Note 2: In case of “auto range” selection, synchronisation could not be selected to current.

Note 3: Current clamps with external current range (range selection on the clamps itself) selection does not support “auto range”.

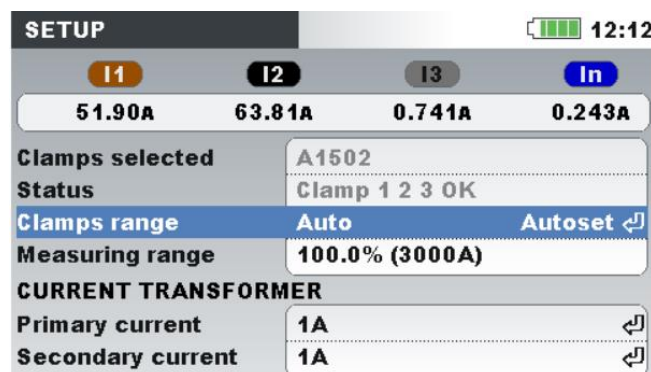

Figure 23: Smart current clamps auto range selection

Direct current measurement with clamp-on current transformer

In this type of measurement load/generator current is measured directly with one of clap-on current transformer. Current to voltage conversion is *performed directly* by the clamps.

Direct current measurement can be *performed* by any clamp-on current transformer. We particularly recommend Smart clamps: flex clamps A 1502, A1227 and iron clamps A1281, A 1588 for example. Also, other Metrel clamp models A1033 (1000 A), A1069 (100 A), etc. can be used. For more details about the current clamps, please check the Metrel’s General catalogue.

In the case of large loads there can be few parallel feeders which can’t be embraced by single clamps. In this case we can measure current only through one feeder as shown on figure below.

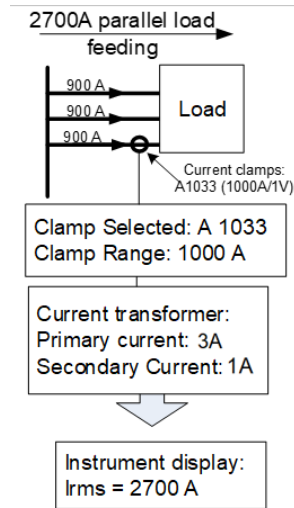
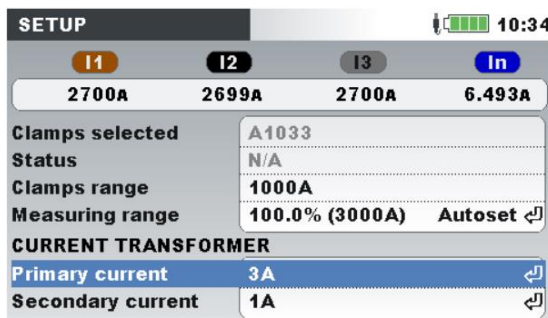

Figure 24: Parallel feeding of large load

Example: 2700 A current load is fed by 3 equal parallel cables. In order to measure current, we can embrace only one cable with clamps, and select: **Current transformer, Primary current: 3 A, Secondary current: 1 A** in clamp menu.

Note: During setup current range can be observed by “Measuring range: 100% (3000 A/V)” row.

Indirect current measurement

Indirect current measurement with primary current transducer is assumed if user selects 5 A current clamps: A 1588 or A 1037. Load current is in that case measured **indirectly** through additional primary current transformer.

In **example** below we have 100 A of primary current flowing through primary transformer with ratio 600 A : 5 A. Settings are shown in following figure.

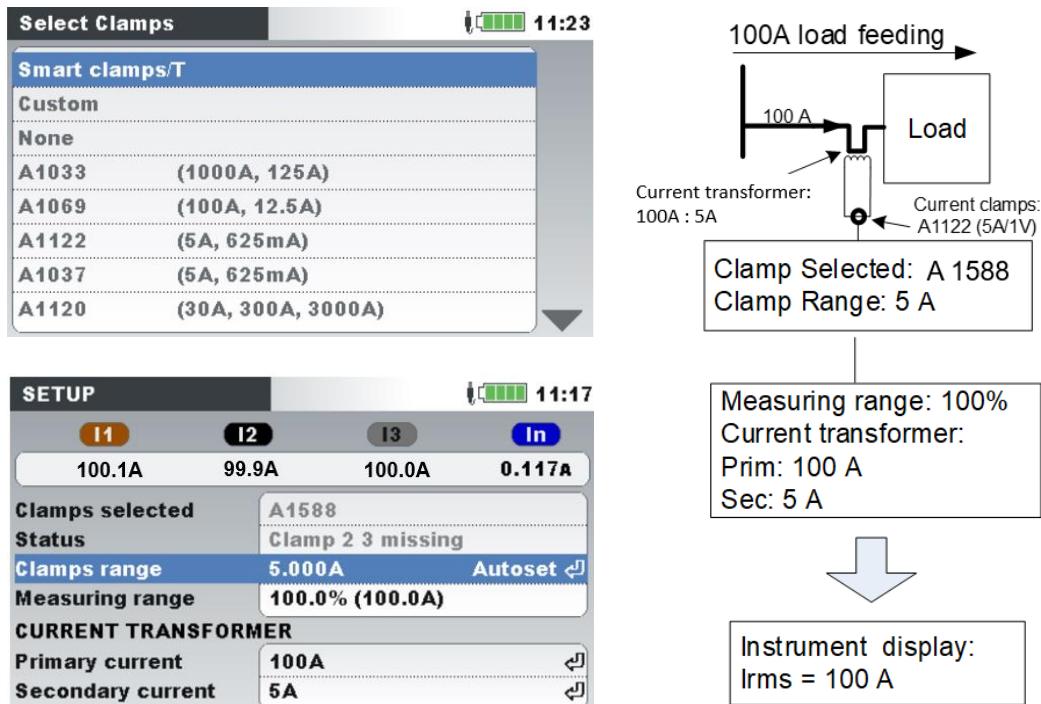

Figure 25: Current clamps selection for indirect current measurement

Over-dimensioned current transformer

Installed current transformers on the field are usually over-dimensioned for “possibility to add new loads in future”. In that case current in primary transformer can be less than 10% of rated transformer current. For such cases it is recommended to select 10% current range as shown on figure below.

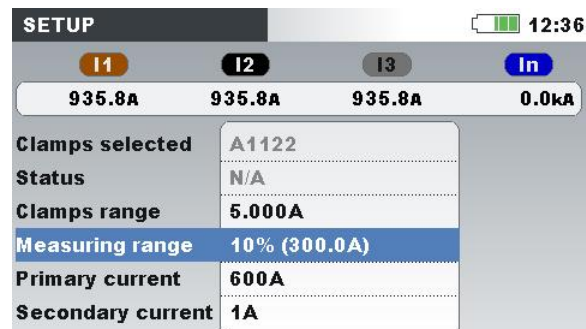

Figure 26: Selecting 10% of current clamps range

Note that if we want to perform direct current measure with 5 A clamps (secondary current measurement), primary transformer ratio should be set to 5 A : 5 A.

⚠ WARNINGS!

- The secondary winding of a current transformer must not be open when it is on a live circuit.
- An open secondary circuit can result in dangerously high voltage across the terminals.

Automatic current clamps recognition

Metrel developed Smart current clamps product family in order to simplify current clamps selection and settings. Smart clamps are multi-range switchless current clamps automatically recognized by instrument. In order to activate smart clamp recognition, the following procedure should be followed for the first time:

1. Turn on the instrument
2. Connect clamps (for example A 1227) to Power Master XT
3. Enter: Measurement Setup → Connection setup → Phase/Neutral Curr. Clamps menu
4. Select: Smart clamps/T
5. Clamps type will be automatically recognized by the instrument.
6. User should then select clamp range (Auto range or fixed one) and confirm settings.

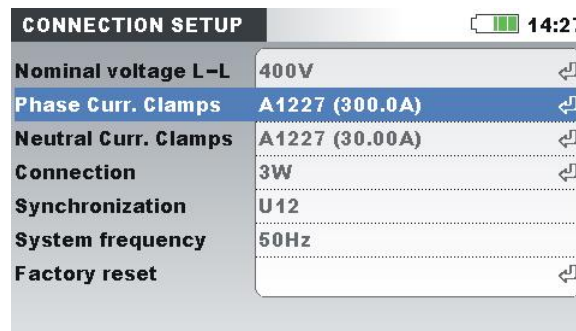

Figure 27: Automatically recognised clamps setup

Instrument will remember clamps setting for the next time. Therefore, user only need to:

1. Plug clamps to the instrument current input terminals
2. Turn on the instrument

Instrument will recognize clamps automatically and set ranges as was settled on measurement before. If clamps were disconnected following pop up will appear on the screen (See Figure below). Use cursor keys to select Smart clamp current range.

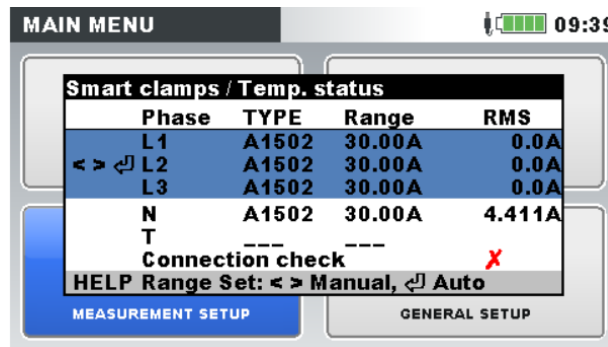



Figure 28: Automatically recognised clamps status

Table 115: Keys in Smart clamps pop up window

	Changes Clamps current range.
	Selects Phase or Neutral current clamps.



Confirms selected range and returns to previous menu.

Clamps Status menu indicates that there is an inconsistency between current clamps defined in Clamps Setup menu and clamps present at the moment.

Note: Do not disconnect smart clamps during recording.

4.2.4 Connection check

Connection check menu in CONNECTION SETUP check if instrument measurement complies with instrument setup and connection.

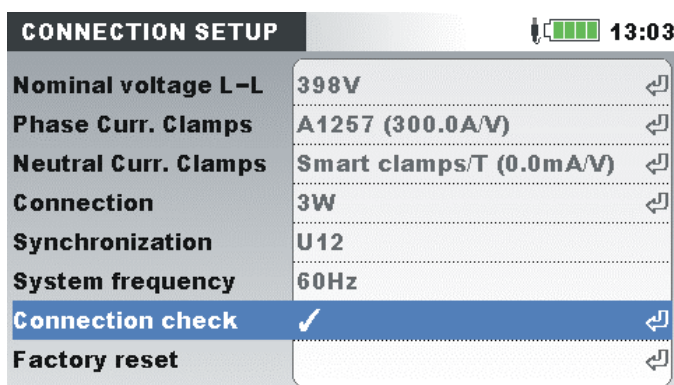

Connection check mark can be marked with OK (✓) or Fail (✗) sign and indicate overall connection status:

- Connection check is marked with green OK sign (✓) if instrument is connected properly and measured values comply with given measurement setup.
- Connection check is marked with yellow OK sign (✓), indicate that some measurements are not as expected. This does not mean that something is necessary wrong, but require user attention to double check connection and instrument settings. In this case, measurements are outside the optimal range.
- Fail sign (✗) indicate that that instrument is connected incorrectly or measurement setup does not correspond with measured value. In this case it is necessary to readjust measurement settings, and check instrument connections.

By pressing ENTER key, detailed Connection check will be shown

Connection: Consumed		08:57		
	L1	L2	L3	N
U	✓ 229.5	✓ 229.8	✓ 229.5	1.03 V
I	✓ 2.500	✓ 3.750	✓ 5.000	1.567 A
P	0.574	0.862	1.147	kW
Phase	✓ 0.0	✓ 0.0	✓ 0.0	359.0 °
Useq	✓ 1 2 3	Ptot	2.583	kW
Iseq	✓ 1 2 3	f	✓ 49.999	Hz
DATE/TIME	VIEW		LIMITS	

Table 116: Connection check description and screen symbols

Measurement	Status	Description	Action to resolve issue
U		Measured voltage is within 90% ÷ 110% range. All voltage measurements (RMS, harmonics, voltage events) are valid.	
U		Measured voltage is not within 90% ÷ 110% range of Nominal voltage. All voltage measurements (RMS, harmonics, voltage events) can be compromised.	Set correct Nominal voltage value and check voltage leads.
I		Measured current is within 10% ÷ 110% of selected clamp measuring range. All current measurements (RMS, harmonics, voltage events) are valid.	
I		Measured current is within 5% ÷ 10% or 110% ÷ 150% of selected clamp measuring range.	If higher current is expected during recorder campaign, this warning can be ignored. Otherwise it is recommended to decrease current range.
I		Measured current is less than 5% or higher than 150% of clamp measuring range. Accuracy of current measurements (RMS, harmonics...) can be compromised.	Go to Current clamp settings and change Clamp Measuring Range or press AUTOSET I button and let instrument to choose optimal current range.
Phase		Phase angle between voltage and current is less than 90°. This indicate that measured current flow in the same direction as voltage. Power measurements are valid.	
Phase		Phase angle between voltage and current is more than 90°. This indicate that measured current has opposite flow than voltage. Power measurements are compromised.	Check clamp direction ( icon is present in status bar) and see if current channel corresponds to the voltage channel (if current I ₁ is measured on voltage U ₁)
Useq	123	Voltage sequence is correct. Unbalance and power measurement are valid.	
Useq	321	Voltage sequence is reverse. Unbalance and power measurement are compromised.	Switch voltage leads U ₂ and U ₃ in-between to obtain right sequence.
Useq	-	Phase angle between voltages is not 120° ± 30°. Unbalance and power measurement are compromised.	Check voltage leads, and check if selected Connection correspond to the actual network.
Iseq	123	Current sequence is correct, phase angle between currents is less than 120° ± 60°. Unbalance and power measurement are valid.	
Iseq	123	Current sequence is correct, but phase angle between currents is more than 120°	This is valid situation if there are large inductive/capacitive load in

















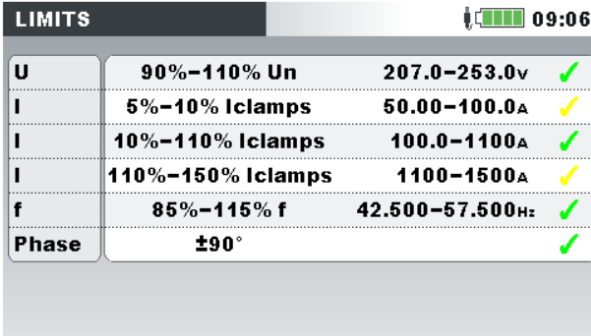











		$\pm 60^\circ$.	the network. However, this can be also caused by improper instrument connection. Check clamp direction ( icon is present in status bar) and see if current channel corresponds to the voltage channel (if current I_1 is measured on voltage U_1).
Iseq	 321	Current sequence is reverse. Unbalance and power measurement are compromised.	Switch current clamps I_2 and I_3 in-between.
Iseq	 -	Current phase angle between currents is not $120^\circ \pm 60^\circ$. Unbalance and power measurement are compromised.	Check voltage leads, and check if selected Connection correspond to the actual network.

Table 117: Keys in Connection check screen

	DATE/TIME	Open Date/time setup screen (for quick real-time clock check)																												
	VIEW	Selects which measurement setup should be considered: Consumed or Generated.																												
	AUTOSET I	MI 2893 performs the most optimal clamp current range (Auto range is performed automatically)																												
	LIMITS	<p>Check limits for measured parameters:</p>  <table border="1"> <thead> <tr> <th colspan="3">LIMITS</th> <th> 09:06</th> </tr> </thead> <tbody> <tr> <td>U</td> <td>90%–110% U_n</td> <td>207.0–253.0v</td> <td></td> </tr> <tr> <td>I</td> <td>5%–10% I_{clamps}</td> <td>50.00–100.0A</td> <td></td> </tr> <tr> <td>I</td> <td>10%–110% I_{clamps}</td> <td>100.0–1100A</td> <td></td> </tr> <tr> <td>I</td> <td>110%–150% I_{clamps}</td> <td>1100–1500A</td> <td></td> </tr> <tr> <td>f</td> <td>85%–115% f</td> <td>42.500–57.500Hz</td> <td></td> </tr> <tr> <td>Phase</td> <td>$\pm 90^\circ$</td> <td></td> <td></td> </tr> </tbody> </table>	LIMITS			 09:06	U	90%–110% U_n	207.0–253.0v		I	5%–10% I_{clamps}	50.00–100.0A		I	10%–110% I_{clamps}	100.0–1100A		I	110%–150% I_{clamps}	1100–1500A		f	85%–115% f	42.500–57.500Hz		Phase	$\pm 90^\circ$		
LIMITS			 09:06																											
U	90%–110% U_n	207.0–253.0v																												
I	5%–10% I_{clamps}	50.00–100.0A																												
I	10%–110% I_{clamps}	100.0–1100A																												
I	110%–150% I_{clamps}	1100–1500A																												
f	85%–115% f	42.500–57.500Hz																												
Phase	$\pm 90^\circ$																													
		Returns to the one menu back.																												

4.2.5 Temperature probe connection

Temperature measurement is performed using smart temperature probe connected to the any current input channel. In order to activate temperature probe recognition, following procedure should be followed for the first time:



1. Turn on the instrument
2. Connect temperature probe to Power Master XT neutral current input terminal
3. Enter: Measurement setup → Connection setup → Phase/Neutral curr. clamps
4. Select: Smart clamps/T
5. Temperature probe should be now automatically recognized by the instrument

Instrument will remember settings for the next time. Therefore, user only needs to plug temperature probe to the instrument.

4.2.6 GPS time synchronization device connection

Power Master XT has the ability to synchronize its system time clock with Coordinated Universal Time (UTC time) provided by externally connected GPS module (optional accessory - A 1355). In order to be able to use this particular functionality, GPS unit should be attached to the instrument and placed outside. Once this is done, GPS module will try to establish connection and get satellite time clock. Power Master XT distinguishes two different states regarding GPS module functionality.

Table 118: GPS functionality

	GPS module detected, position not valid or no satellite GPS signal reception.
	GPS module detected, satellite GPS signal reception, date and time valid and synchronized, synchronization pulses active

Once an initial position fix is obtained, instrument will set time and date to GPS + Time zone - user selected in Set Date/Time menu (see figure below).

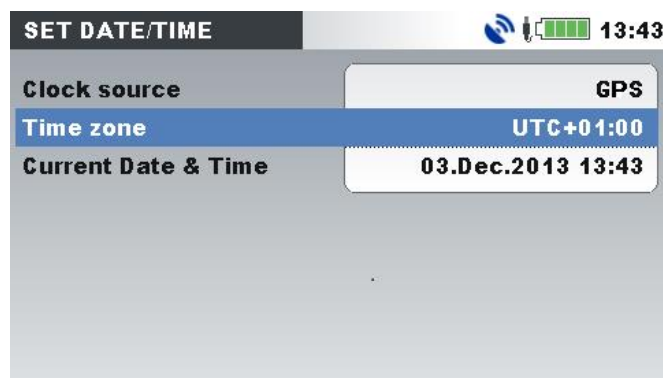



Figure 29: Set time zone screen

Table 119: Keys in Set time zone screen

	Changes Time zone.
	Confirms selected Time zone and returns to "GENERAL SETUP" menu.

When the time zone is set, Power Master XT will synchronize its system time clock and internal RTC clock with the received UTC time. GPS module also provides the instrument with extremely accurate synchronization pulses every second (PPS – Pulse Per Second) for synchronization purposes in case of lost satellite reception.

Note: GPS synchronization should be done before starting measurements.

For detailed information please check user manual of A 1355 GPS Receiver.

4.2.1 Printing support

Power Master XT supports direct printing to Seiko DPU 414 printer. User can print any screen under MEASUREMENTS menu. In order to print, connect instrument with the printer according to the figure

below and press and hold **ESC** key for 5 seconds. Characteristic “beep” signal will indicate that printing is started.

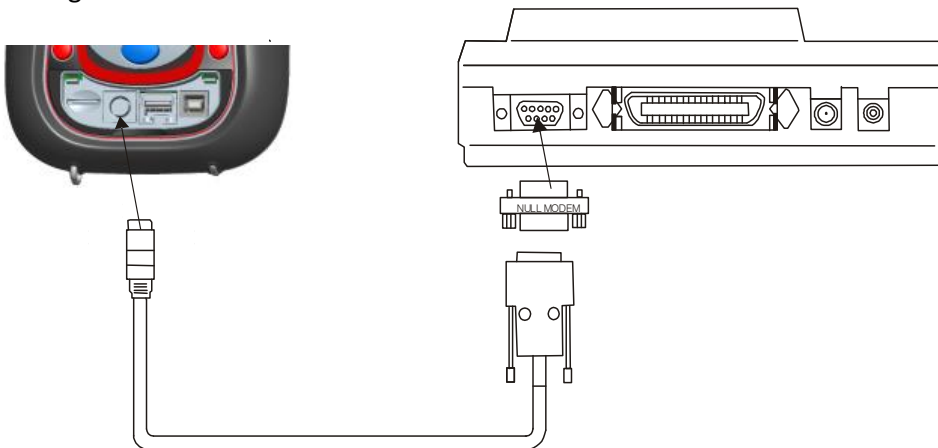

Figure 30: Connecting printer DPU 414 with instrument

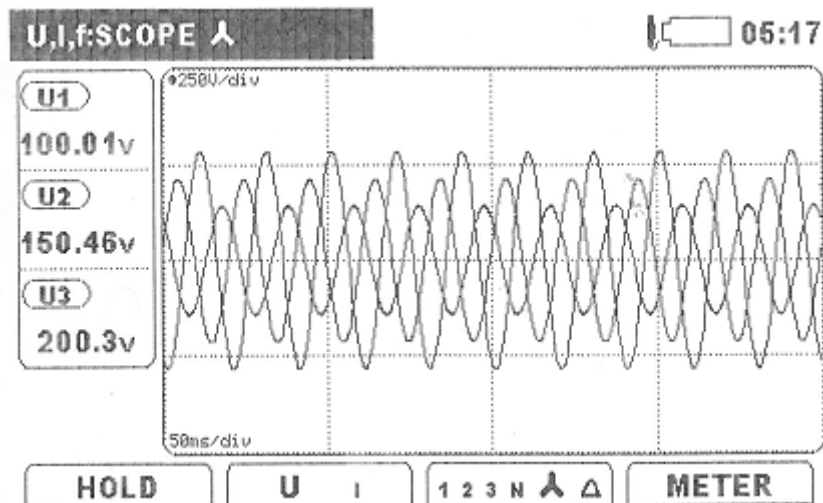

Figure 31: SCOPE screen print

Instructions for printer setup

Printer is configured to work with instrument directly. However, if non-original printer device is used, printer should be properly configured before use, according to the following procedure:

1. Fit paper into printer.
2. Turn off printer.
3. Hold “On Line” key and turn on printer.
Printer will print settings of dip switches.
4. Press “On Line” key to continue.
5. Press “Feed” key in order to set **Dip SW-1, SW No. 1** (OFF) according to the table below.
6. Press “On line” key in order to set **Dip SW-1, SW No. 2** (ON) according to the table below.
7. Continue procedure according to the table below.
8. After **Dip SW-1, SW No. 8** is set, press Continue – “On line” key.
9. Continue procedure according to the table below: **Dip SW-2** and **Dip SW-3**.
10. After **Dip SW-3 No. 8** is set, press Write – “Feed” key for saving new configuration into memory.
11. Turn Off/On printer.

Table 120: DPU 414 Dip switches settings are shown on table below:

SW No.	Dip SW-1		Dip SW-2:		Dip SW-3	
1.	OFF	Input = Serial	ON	Printing Colums = 40	ON	Data Length = 8 bits
2.	ON	Printing Speed = High	ON	User Font Back-up = ON	ON	Parity setting = No
3.	ON	Auto Loading = ON	ON	Character Sel. = Normal	ON	Parity condition = Odd
4.	OFF	Auto LF = OFF	ON	Zero = Normal	OFF	Busy Control = XON/XOFF
5.	OFF	Setting Cmd. = Disable	ON	International	OFF	Baud Rate Select = 19200 bps
6.	OFF	Printing Density = 100%	ON	Character Set U.S.A.	ON	
7.	ON		ON		ON	
8.	ON		OFF		OFF	

Note: Use "On Line" key as "OFF" and "Feed" key as "ON".

4.3 Remote instrument connection (over Internet/Internet(3G/GPRS)/Intranet (LAN))

4.3.1 Communication principle

Power Master XT instrument use Ethernet port for connection to PowerView through internet. As companies frequently use firewalls to limit internet traffic options, whole communication is routed through dedicated "Metrel Route Server". In this way instrument and PowerView can avoid firewalls and router restrictions. Communication is established in four steps:

1. User selects INTERNET or INTERNET (3G/GPRS) or INTRANET (LAN) connection under COMMUNICATION menu, and checks if connection to Metrel server can be established (Status bar icon  should appear within 2 minutes).
Note: Outgoing ports 80, 443, 7781 ÷ 8888 to the gprs.metrel.si server should be opened on remote firewall where instrument is placed!
2. User enters instrument serial number on PowerView and connects to the instrument over Metrel server.

Note: In case of using accessory A 1622 3G Wi-Fi modem for internet connection, please check A 1622 instruction manual in order to properly set up modem, before using it.

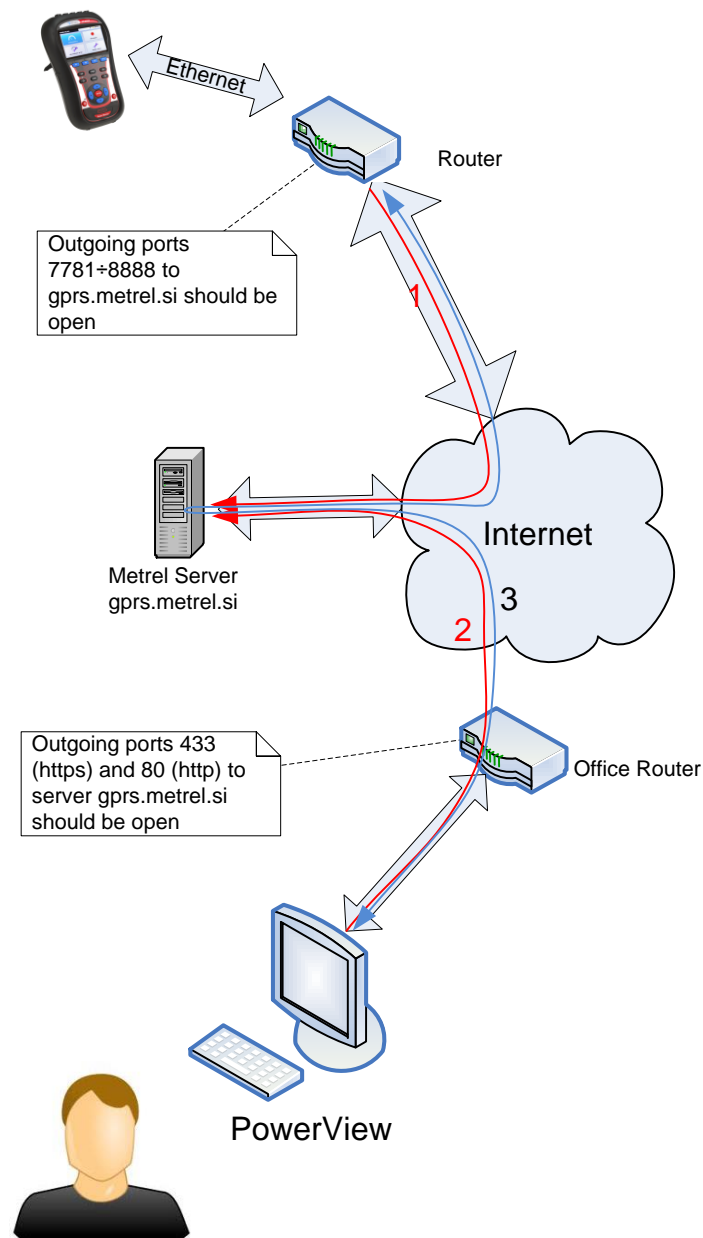

Figure 32: Schematic view on the remote measurements

4.3.2 Instrument setup on remote measurement site

Installation procedure on remote site starts by connecting Power Master XT instrument to the grid or measurement point. As measurement campaign can last for days or weeks it is necessary to assure reliable power supply to the instrument. Additionally, fully charged instrument batteries can provide power to the instrument during interrupts and blackouts for more than 5 hours. After instrument installation, connection parameters should be set.

In order to establish remote connection with instrument through PC software PowerView v3.0, instrument communication parameters should be configured. Figure below shows COMMUNICATION menu in GENERAL SETUP.

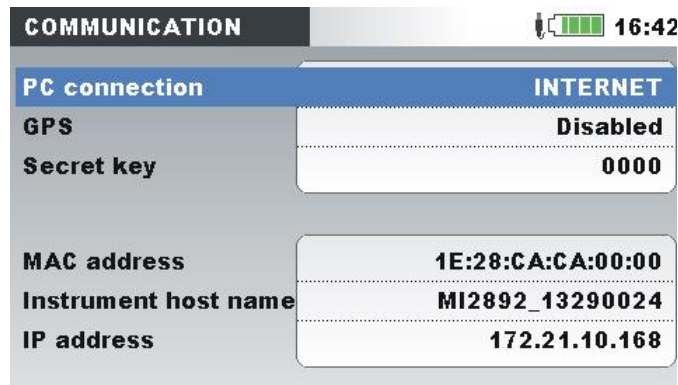

Figure 33: Internet connection setup screen

Following parameters should be entered in order to establish Internet communication:

Table 121: Internet setup parameters



PC connection	Internet	Select internet connection in order to communicate with PowerView over internet connection.
Secret key	0000	Enter number code (4-digits). User need to store this number, as will be later asked by PowerView v3.0, during connection procedure

After entering parameters user should connect Ethernet cable. Instrument will receive IP address from DHCP Server. It can take up to 2 minutes in order to get new IP number. Once instrument IP address is obtained, it will try to connect to Metrel server, over which communication with PowerView is assured.

Once everything is connected,  icon will appear on the Status bar.

Connection status can be also observed on instrument Status bar, as shown on table below.

Table 122: Internet status bar icons

	Internet connection is not available. Instrument is trying to obtain IP address and then connect to Metrel server.
	Instrument is connected to the internet and Metrel server, and ready for communication. Note: Outgoing ports 80, 443, 7781 ÷ 8888 to the gprs.metrel.si server should be opened on remote firewall!
	Communication in progress. Instrument is connected to the PowerView instance.

4.3.3 PowerView setup for instrument remote access

In order to access remotely to the instrument, PC software PowerView v3.0 should be configured properly (See PowerView v3.0 manual for instructions how to install to your PC). PowerView v3.0 communicates over 80 and 443 ports, on similar way as your internet browser.

Note: Outgoing ports 80, 443 to the gprs.metrel.si server should be opened on local firewall!

PowerView settings

Press on Remote  in toolbar in order to open remote connection settings, as shown on figure below.

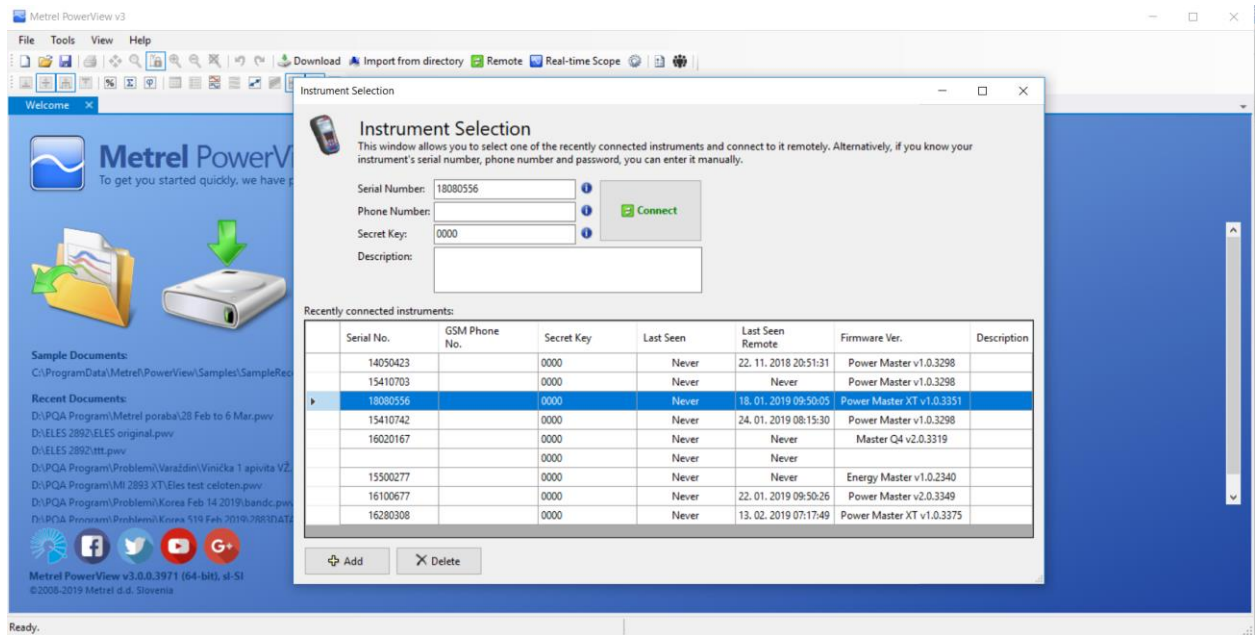

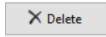



Figure 34: PowerView v3.0 remote connection settings form

User needs to fill following data into form:

Table 123: Instrument selection form parameters

Serial Number:	Required	Enter Power Quality Analyser serial number
Phone Number:	Not Required	Leave this field empty
Secret Key:	Required	Enter number code which was entered in instrument Communication settings menu as: Secret Key.
Description:	Optional	Enter instrument description

By pressing  button, user can add another instrument configuration.  button is used to remove selected instrument configuration from the list. Connection procedure will begin, by pressing on  button.

4.3.4 Remote connection

Establishing connection

After entering PowerView v3.0 remote settings and pressing on **Connect** button, Remote Connection window will appear (shown below).

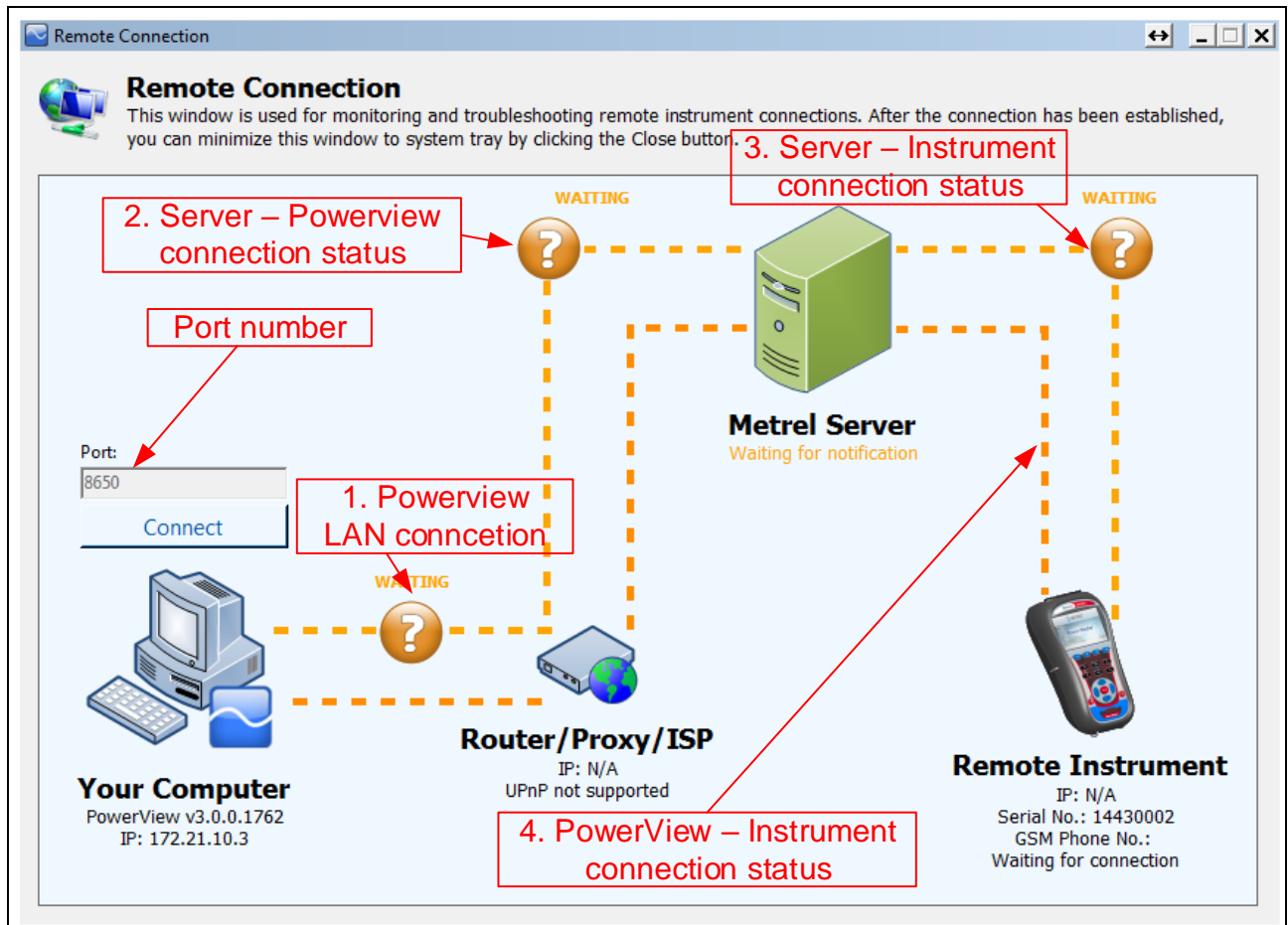

Figure 35: PowerView v3.0 remote connection monitor

This window is used for monitoring and troubleshooting remote instrument connection. Remote connection can be divided into 4 steps.

Step 1: PowerView v3.0 connection to Local Area Network (LAN)

After entering “Remote Connection” PowerView v3.0 will try to establish internet connection automatically. In order to establish connection, PowerView v3.0 requires http connection to the internet. If connection was successful, a green icon and “CONNECTED” status will appear between “Your Computer” and “Router/Proxy/ISP” icons, as shown on figure below. In case of ERROR, please ask your network administrator to provide PowerView v3.0 http access to the internet.

Step 2: PowerView v3.0 connection to Metrel Server

After establishing internet connection in Step 1, PowerView v3.0 will contact Metrel Server. If connection was successful, a green icon and “CONNECTED” status will appear between “Metrel Server” and “Router/Proxy/ISP” icons, as shown on figure below. In case of ERROR, please ask your network administrator for help. Note, that outgoing communication to gprs.metrel.si over 80 and 443 ports should be enabled.

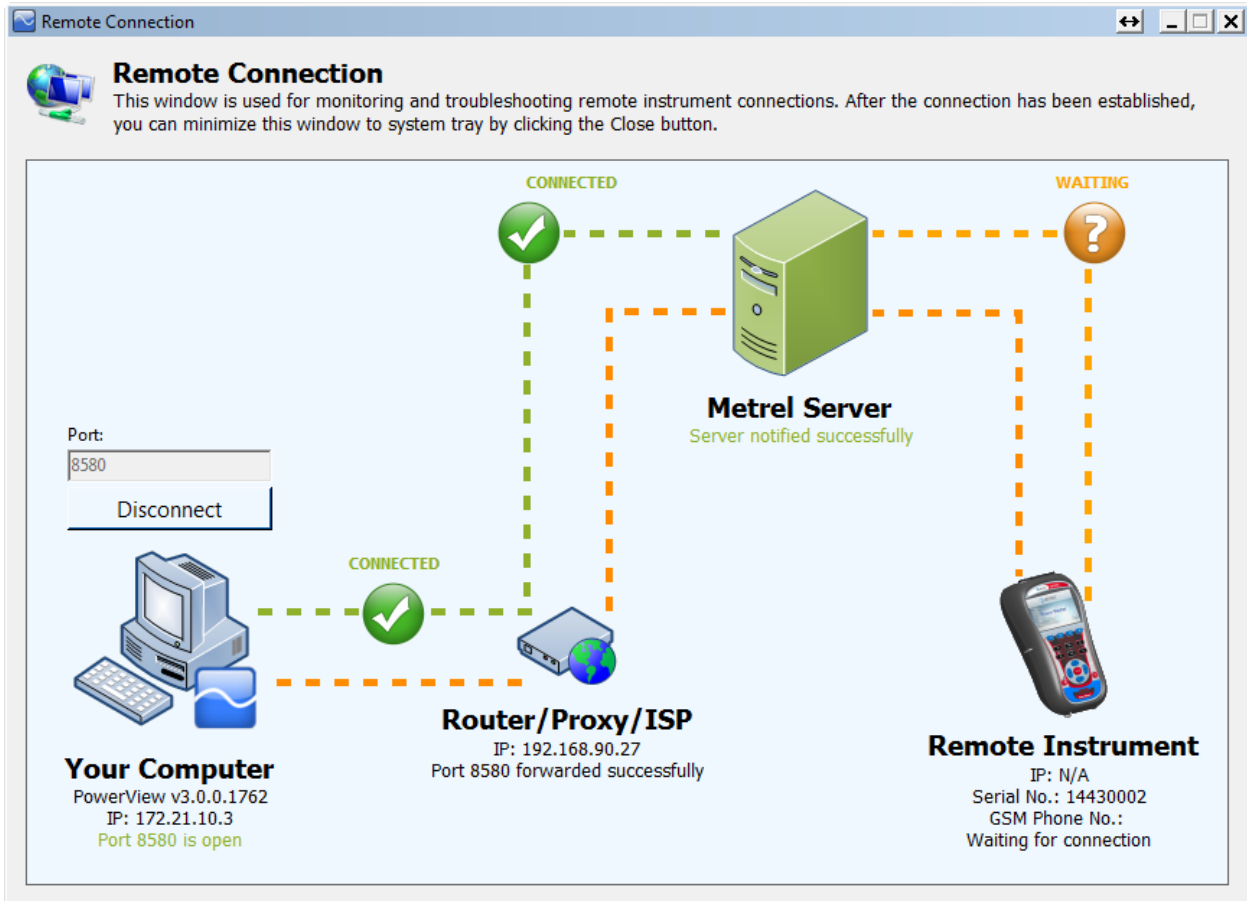

Figure 36: PowerView connection to LAN and Metrel Server established (Steps 1 & 2)

Note: Step 1 and Step 2 are automatically executed, after entering Remote Connection.

Step 3: Remote Instrument connection to Metrel Server

After the PowerView v3.0 successful connects to the Metrel Server, server will check if your instrument is waiting for your connection. If that is a case, instrument will establish connection with Metrel server. The green icon and "CONNECTED" status will appear between "Metrel Server" and "Remote Instrument" icon, as shown on figure below.

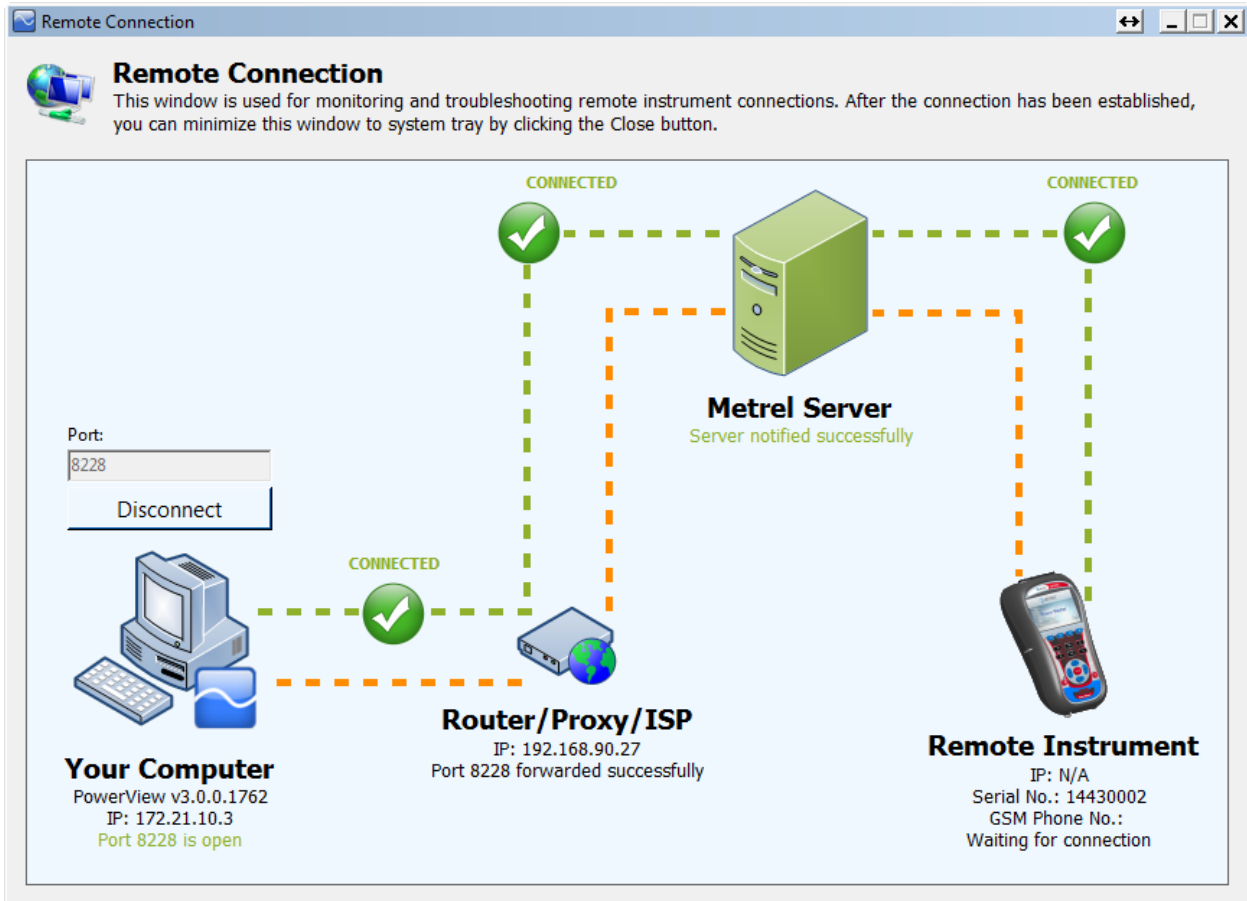

Figure 37: Remote instrument connection to Metrel Server established (Step 3)

Step 4: Remote Instrument connection to PowerView v3.0

After first three steps were successfully finished, Power Master XT instrument will automatically connect to the PowerView v3.0 via VPN connection, made through Metrel server and establish connection. If Remote Instrument connection to PowerView v3.0 was successful, a green icon and "CONNECTED" status will appear between "Router/Proxy/ISP" and "Remote Instrument" icon, as shown on figure below. This window can now be closed as it is not needed any more. and it should be proceeded to remote instrument access described in following sections.

In case if connection drops status "ERROR" or "WAITING" will appear in PowerView remote connection window. Connection will be automatically restored and started operation will continue.

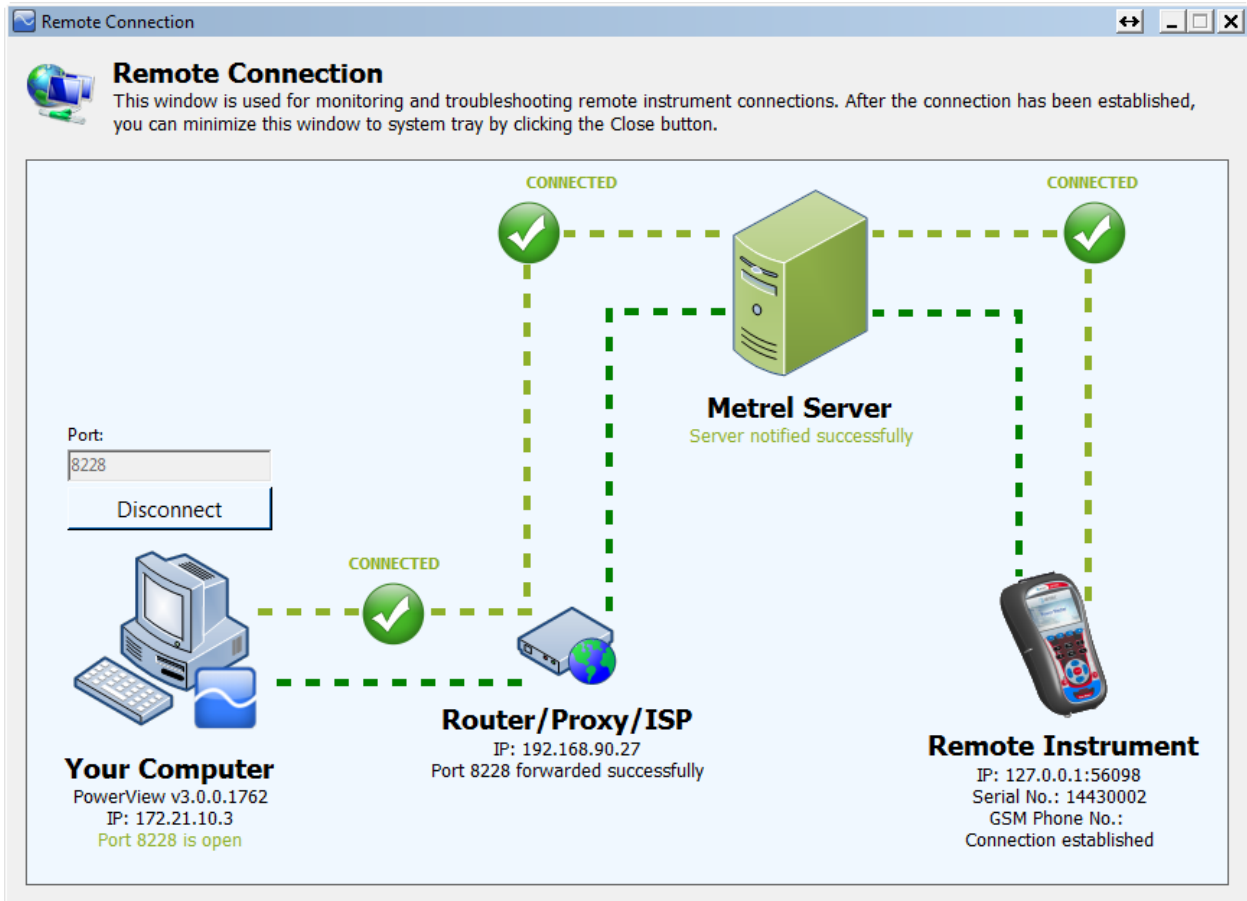

Figure 38: Remote instrument connection to PowerView v3.0 established (Step 4)

While the data is refreshed, the Remote button is displayed in green, to indicate that the connection is active, as shown below. If it is displayed in orange colour, it means that the communication was broken and it should be reinitialized by user.

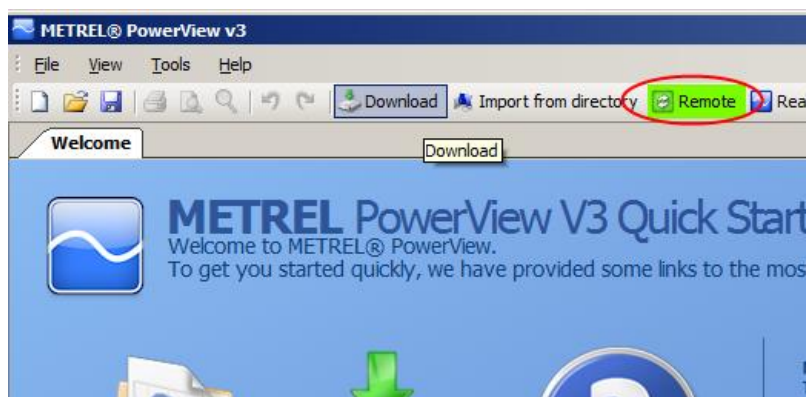

Figure 39: Active connection indication



Remote connection screen can also be accessed through Windows tray bar, by clicking on  icon. This is particularly useful to reconnect instrument and PowerView v3.0, after network failure.



Figure 40: Remote connection icon

Downloading data

If remote connection settings are correct and “Remote Instrument” is connected to PowerView v3.0, download data is possible. Open the download window by pressing F5, or by clicking on the

 **Download** button in the toolbar, or by selecting Download from Tools menu.

Download window will be displayed, and PowerView v3.0 will immediately try to connect to the instrument and detect the instrument model and firmware version.

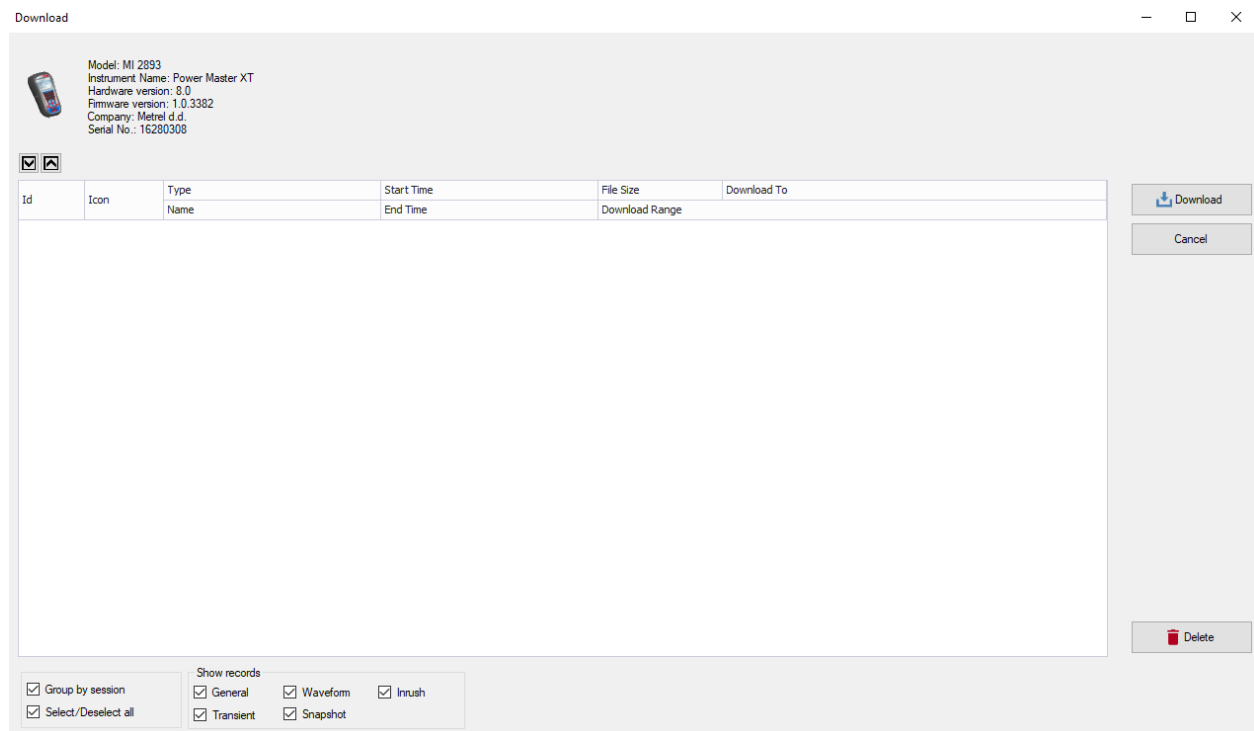

Figure 41: Detection of the instrument type

After a moment, instrument type should be detected, or an error message will be received, with the appropriate explanation. If connection can't be established, please check your connection settings.

When the instrument model is detected, PowerView v3.0 will download a list of records from the instrument. Any of the records from the list can be selected by simply clicking on them. Additionally, “Select/Deselect all” tick box is available to select or deselect all records on displayed page. Selected records entries will have a green background.

Before downloading, a destination site node for each record can be defined. Each entry in a list contains a drop-down list of sites in all currently open documents in PowerView v3.0. If no document is opened, all records will be downloaded to a new site and saved into a new file.

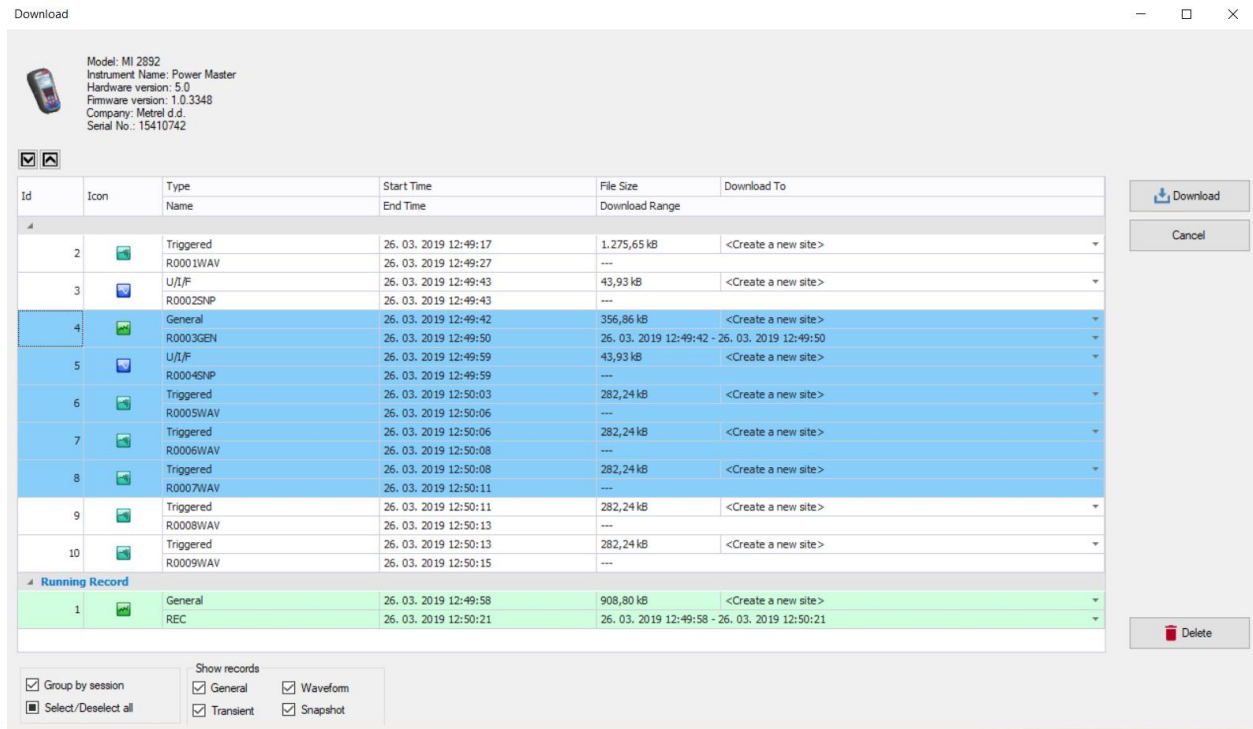

Figure 42: Selecting records from a list for download

Figure above show example were six records are select. To start download, click on the “Download” button.

Immediately after download, a new document window will be shown in PowerView v3.0, with the selected records placed inside a new site node. A backup PowerView v3.0 file is always created at this point, compressed into a *.zip file and saved inside your *MyDocuments/Metrel/PowerView/PQData* folder. This backup copy is made every time a file is created or opened, to make sure that you can recover all your downloaded data in case of accidental delete or change. However, note that records that were not selected in the Download window are not downloaded and therefore not saved to disk, so check that all relevant records are downloaded before deleting them from the instrument.

Real time scope

If remote connection settings are correct and remote instrument is connected to PowerView v3.0, click the Real-Time Scope button to open the Real time scope window. A new document window will be opened, as shown on the picture below.

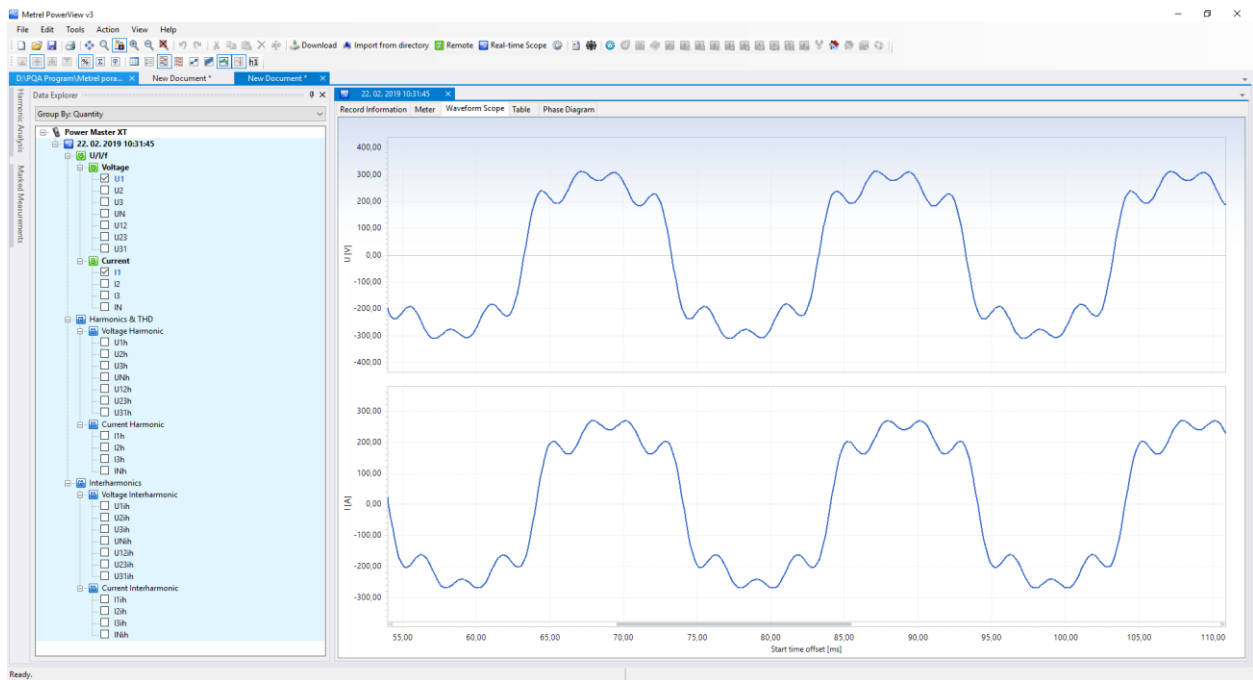
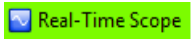
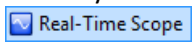

Figure 43: Real time scope window in remote connection, with several channels selected

The figure above shows an online window, with several channels selected. While online view is active, data are automatically updated. Updating speed will depend on your connection speed, and each new update is initiated as soon as the previous one has been downloaded, to ensure fastest possible refresh rate. While Real time scope is active,  Real-Time Scope button is displayed in green, to indicate that the connection is active.

Depending on your connection speed, it may take a few seconds until the instrument is detected and first online scope is downloaded. All tree nodes will be completely expanded when the first record is shown, to enable easier channel selection. You may also notice that the downloaded record node will not be located within a site node, like in other records, but rather placed in a special instrument node. However, this record can be moved to any other node, or saved.

To close the online view, click the  Real-Time Scope button again, or close the online window.

Remote instrument configuration

Instrument configuration tool helps you to change instrument settings, manage recording settings, start or stop recordings and manage instrument memory remotely. In order to begin, select “Remote instrument configuration” in PowerView v3.0 “Tools” menu. A form shown on figure below should pop up on the screen.

Note: Remote connection procedure described in 4.3 should be performed successfully before starting remote instrument configuration.

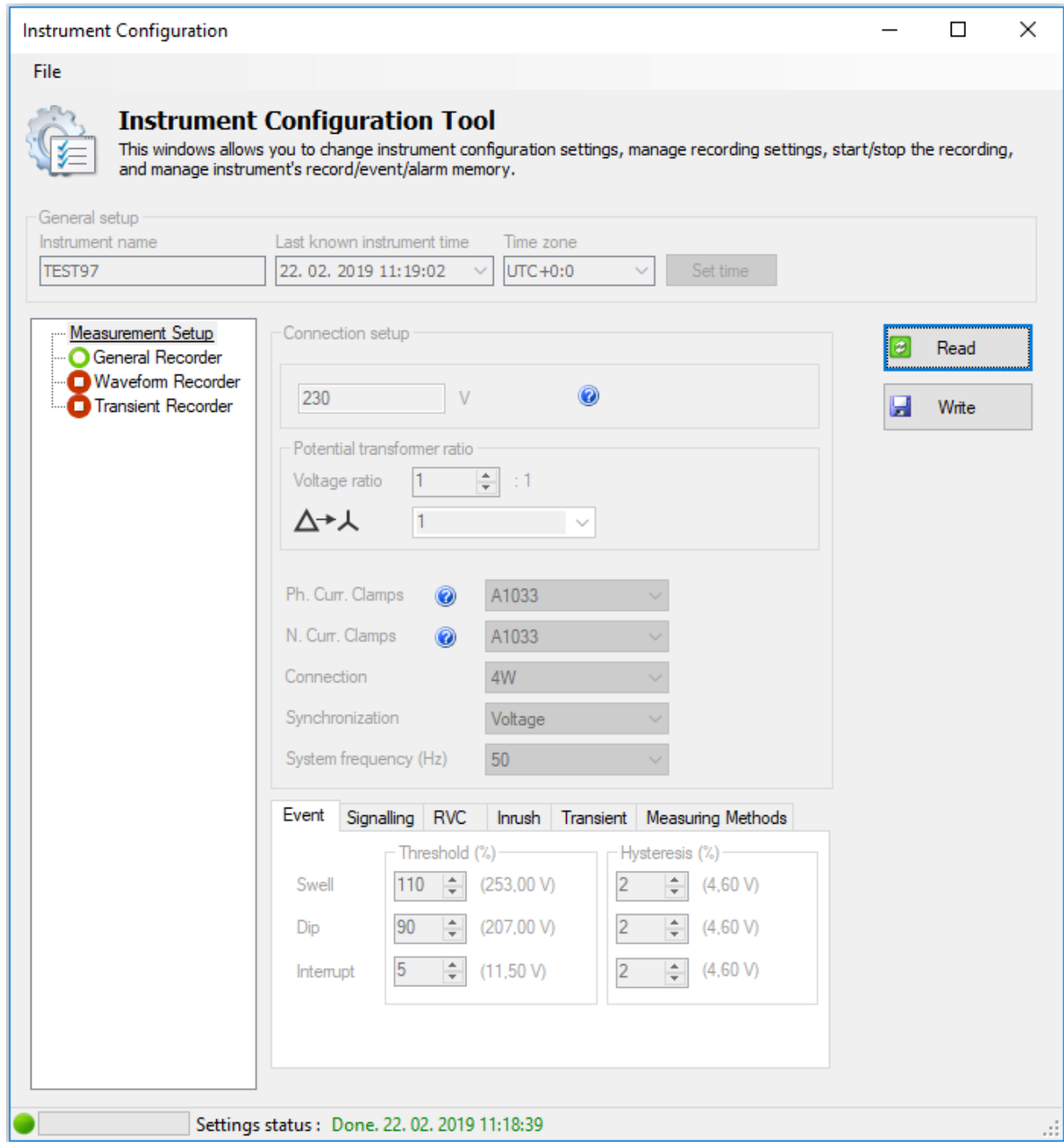

Figure 44: Remote Instrument Configuration form

Please click on the “Read” button in order to receive current instrument settings. After retrieving data from the remote instrument, form should be filled with data, as shown on figure below. Changed parameters, will be sent back to the instrument by clicking on the “Write” button. In order to remotely control instrument recorders, please click on the “Recorder” node as shown on figure below. User can select any of the instrument recorders and configure accompanying parameters. For description of particular recorder settings, see appropriate section in this manual. Changed parameters, will be sent back to the instrument by clicking on the “Write” button.

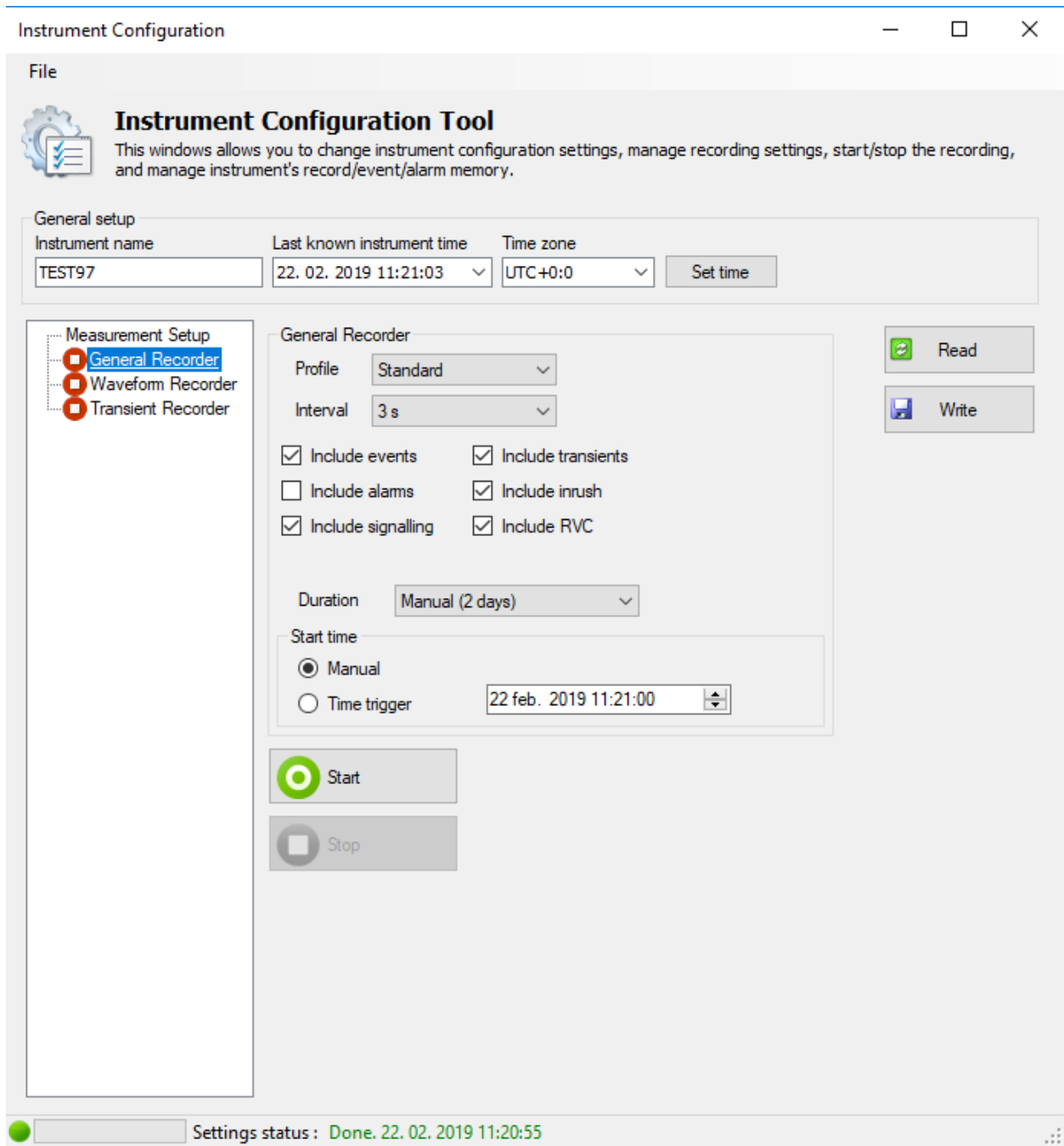

Figure 45: Remote Recorder configuration

By clicking on “Start” button, instrument will start selected recorder in the same manner as would user start recorder directly on instrument. Green icon indicates that Recorder is active, while red icon indicates that recorder is stopped.

Additionally, PowerView v3.0 will disable changing parameters during recording. Trigger button in waveform or transient recorder will trigger recorder in similar way as TRIGGER button on instrument, when pressed. Recording can be terminated by pressing on “Stop” button, or will automatically finish, after conditions are met, for example after given period of time or after event capturing. By pressing on “Read” button, user can receive instrument status in any moment.

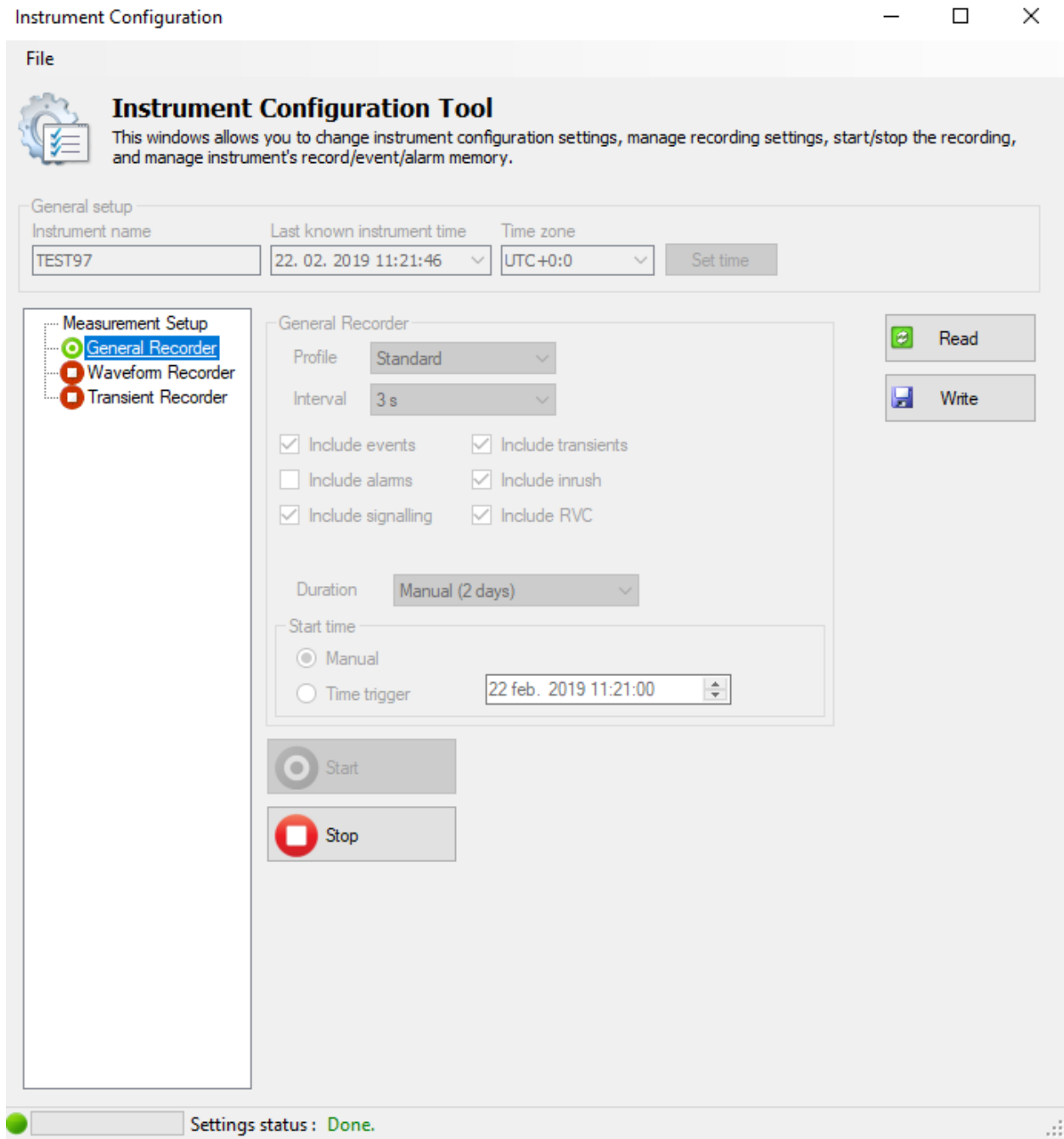

Figure 46: Recording in progress

4.4 Number of measured parameters and connection type relationship

Parameters which Power Master XT Displays and measures, mainly depends on network type, defined in CONNECTION SETUP menu – **Connection** type. In example if user choose single phase connection system, only measurements relate to single phase system will be present. Table below shows dependencies between measurement parameters and type of network.

Table 124: Quantities measured by instrument

Menu		Connection type																							
		1W		2W				3W				OpenD				4W									
		L1	N	L1	L2	N	L12	Tot	L12	L23	L31	Tot	L12	L23	L31	Tot	L1	L2	L3	N	L12	L23	L31	Tot	
Voltage	RMS	•	•	•	•	•	•		•	•	•		•	•	•		•	•	•	•	•	•	•		
	THD	•	•	•	•	•			•	•	•		•	•	•		•	•	•	•					
	Crest Factor	•	•	•	•	•	•		•	•	•		•	•	•		•	•	•	•	•	•	•		
	Frequency	•		•					•				•				•								
	Harmonics (0-50)	•	•	•	•	•			•	•	•		•	•	•		•	•	•	•					
	Interharm. (0-50)	•	•	•	•	•			•	•	•		•	•	•		•	•	•	•					
	Unbalance							•				•				•								•	
	Flicker	•		•	•				•	•	•		•	•	•		•	•	•						
	Signalling	•		•	•				•	•	•		•	•	•		•	•	•						
	Events	•		•	•				•	•	•		•	•	•		•	•	•						
		L1	N	L1	L2	N	L12	Tot	L1	L2	L3	Tot	L1	L2	L3	Tot	L1	L2	L3	N	L12	L23	L31	Tot	
Current	RMS	•	•	•	•				•	•	•		•	•	•		•	•	•						
	THD	•	•	•	•				•	•	•		•	•	•		•	•	•						
	Harmonics (0-50)	•	•	•	•				•	•	•		•	•	•		•	•	•						
	Interharm. (0-50)	•	•	•	•				•	•	•		•	•	•		•	•	•						
	Unbalance							•				•				•								•	
Consumed Pwr.	Combined	•		•	•			•				•				•	•	•	•	•				•	
	Fundamental	•		•	•			•				•				•	•	•	•	•				•	
	Nonfundament.	•		•	•			•				•				•	•	•	•	•				•	
	Energy	•		•	•			•				•				•	•	•	•	•				•	
	Power factors	•		•	•			•				•				•	•	•	•	•				•	
Generated Pwr.	Combined	•		•	•			•				•				•	•	•	•	•				•	
	Fundamental	•		•	•			•				•				•	•	•	•	•				•	
	Nonfundament.	•		•	•			•				•				•	•	•	•	•				•	
	Energy	•		•	•			•				•				•	•	•	•	•				•	
	Power Factors	•		•	•			•				•				•	•	•	•	•				•	

Menu		Connection type						
		INV - 1W		INV - 3W				
		L1	INV	L12	L23	L31	Tot	INV
Voltage	RMS	•	•	•	•	•		•
	AC		•					•
	DC		•					•
	THD	•		•	•	•		
	Crest Factor	•		•	•	•		
	Frequency	•		•				
	Harmonics (0-50)	•		•	•	•		
	Interharm. (0-50)	•		•	•	•		
	Unbalance							•
	Flicker	•		•	•	•		
	Signalling	•		•	•	•		
	Events	•		•	•	•		
		L1	N	L12	L23	L31	Tot	N
Current	RMS	•	•	•	•	•		•
	AC		•					•
	DC		•					•
	THD	•		•	•	•		
	Harmonics (0-50)	•		•	•	•		
	Interharm. (0-50)	•		•	•	•		
	Unbalance							•
Consumed Pwr.	Combined	•	•				•	•
	AC		•					•
	DC		•					•
	Fundamental	•					•	
	Nonfundament.	•					•	
	Energy	•					•	
	Power factors	•					•	
Generated Pwr.	Combined	•	•				•	•
	AC		•					•
	DC		•					•
	Fundamental	•					•	
	Nonfundament.	•					•	
	Energy	•					•	
	Power Factors	•					•	

Note: Frequency measurement depends on synchronization (reference) channel, which can be voltage or current.

In the similar manner recording quantities are related to connection type too. Recording Signals in GENERAL RECORDER menu are chosen according to the **Connection** type, and record **PROFILE** in according to the next table.

Table 125: Quantities recorded by instrument (Standard Profile)

		Connection type																						
Menu		1W		2W				3W				OpenD				4W								
		L1	N	L1	L2	N	L12	Tot	L12	L23	L31	Tot	L12	L23	L31	Tot	L1	L2	L3	N	L12	L23	L31	Tot
Voltage	RMS																							
	THD																							
	Crest Factor																							
	Frequency																							
	Harmonics (0-50)																							
	Interharm. (0-50)																							
	Unbalance																							
	Flicker																							
	Signalling																							
	Events	•		•	•				•	•	•		•	•	•		•	•	•					
		L1	N	L1	L2	N	L12	Tot	L12	L1	L2	L3	Tot	L2	L3	Tot	L1	L2	L3	N	L12	L23	L31	Tot
Current	RMS																							
	THD																							
	Harmonics (0-50)																							
	Interharm. (0-50)																							
	Unbalance																							
		L1	N	L1	L2	N	L12	Tot	L12	L1	L2	L3	Tot	L2	L3	Tot	L1	L2	L3	N	L12	L23	L31	Tot
Power	Combined																							
	Fundamental																							
	Nonfundament.																							

Active Energy																					
Reactive Ener.																					
Power factors																					

Menu		Connection type						
		INV-1W		INV-3W				
		L1	N	L12	L23	L31	Tot	N
Voltage	RMS							
	AC							
	DC							
	THD							
	Crest Factor							
	Frequency							
	Harmonics (0-50)							
	Interharm. (0-50)							
	Unbalance							
	Flicker							
	Signalling							
	Events	•		•	•	•		
		L1	N	L12	L23	L31	Tot	N
Current	RMS							
	AC							
	DC							
	THD							
	Harmonics (0-50)							
	Interharm. (0-50)							
	Unbalance							

		L1	N	L12	L23	L31	Tot	N
Power	Combined	☐ ☐ ☐ ☐	☐ ☐ ☐ ☐				☐ ☐ ☐ ☐	☐ ☐ ☐ ☐
	AC		☐ ☐ ☐ ☐					☐ ☐ ☐ ☐
	DC		☐ ☐ ☐ ☐					☐ ☐ ☐ ☐
	Fundamental	☐ ☐ ☐ ☐					☐ ☐ ☐ ☐	
	Nonfundament.	☐ ☐ ☐ ☐					☐ ☐ ☐ ☐	
	Active Energy	☐ ☐					☐ ☐	
	Reactive Ener.	☐ ☐					☐ ☐	
	Power factors	☐ ☐ ☐ ☐					☐ ☐ ☐ ☐	

Legend:

- - Quantity included.
- ☐ - Maximal value for each interval is recorded.
- ☐ - RMS or arithmetic average for each interval is recorded (see 5.1.15 for details).
- ☐ - Minimal value for each interval is recorded.
- ☐ - Active RMS or arithmetic average (AvgON) for each interval is recorded (see 5.1.15 for details).

Table 126: Quantities recorded by instrument (Limited Profile)

		Connection type																							
Menu		1W		2W				3W				OpenD				4W									
		L1	N	L1	L2	N	L12	Tot	L12	L23	L31	Tot	L12	L23	L31	Tot	L1	L2	L3	N	L12	L23	L31	Tot	
Voltage	RMS																								
	THD																								
	Crest Factor																								
	Frequency																								
	Harmonics (0-25)																								
	Interharm. (0-25)																								
	Unbalance																								
	Flicker																								
	Signalling																								
	Events	•		•	•				•	•	•		•	•	•		•	•	•						
		L1	N	L1	L2	N	L12	Tot	L12	L1	L2	L3	Tot	L2	L3	Tot	L1	L2	L3	N	L12	L23	L31	Tot	
Current	RMS																								
	THD																								
	Harmonics (0-25)																								
	Interharm. (0-25)																								
	Unbalance																								
		L1	N	L1	L2	N	L12	Tot	L12	L1	L2	L3	Tot	L2	L3	Tot	L1	L2	L3	N	L12	L23	L31	Tot	
Power	Combined																								
	Fundamental																								
	Nonfundament.																								
	Active Energy																								
	Reactive Ener.																								
	Power factors																								

Menu		Connection type						
		INV-1W		INV-3W				
		L1	N	L12	L23	L31	Tot	N
Voltage	RMS							
	AC							
	DC							
	THD							
	Crest Factor							
	Frequency							
	Harmonics (0-50)							
	Interharm. (0-50)							
	Unbalance							
	Flicker							
	Signalling							
	Events	•		•	•	•		
		L1	N	L12	L23	L31	Tot	N
Current	RMS							
	AC							
	DC							
	THD							
	Harmonics (0-50)							
	Interharm. (0-50)							
	Unbalance							
		L1	N	L12	L23	L31	Tot	N
Power	Combined							
	AC							

All voltage measurements represent RMS values of the voltage magnitude over a 10/12-cycle time interval. Every interval is contiguous, and not overlapping with adjacent intervals.

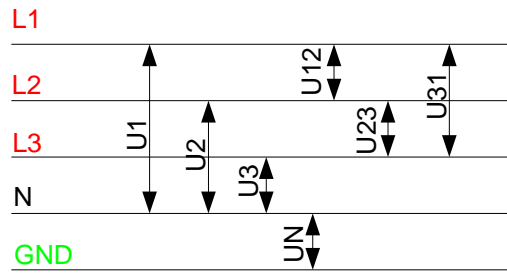

Figure 136: Phase and Phase-to-phase (line) voltage

Voltage values are measured according to the following equation:

$$\text{Phase voltage: } U_p = \sqrt{\frac{1}{M} \sum_{j=1}^M u_{p_j}^2} \quad [\text{V}], p: 1,2,3,N \quad (1)$$

$$\text{Line voltage: } U_{pg} = \sqrt{\frac{1}{M} \sum_{j=1}^M (u_{p_j} - u_{g_j})^2} \quad [\text{V}], pg.: 12,23,31 \quad (2)$$

$$\text{Phase voltage crest factor: } CF_{U_p} = \frac{U_{pPk}}{U_p}, p: 1,2,3,N \quad (3)$$

$$\text{Line voltage crest factor: } CF_{U_{pg}} = \frac{U_{pgPk}}{U_{pg}}, pg.: 12, 23, 31 \quad (4)$$

The instrument has internally 3 voltage measurement ranges, which are automatically selected regarding to the nominal voltage.

5.1.3 Current measurement (magnitude of supply current)

Standard compliance: Class A (Section 5.13)

All current measurements represent RMS values of the samples of current magnitude over a 10/12-cycle time interval. Each 10/12-cycle interval is contiguous and non-overlapping.

Current values are measured according to the following equation:

$$\text{Phase current: } I_p = \sqrt{\frac{1}{M} \sum_{j=1}^M I_{p_j}^2} \quad [\text{A}], p: 1,2,3,N \quad (5)$$

$$\text{Phase current crest factor: } I_{p_{cr}} = \frac{I_{p_{\max}}}{I_p}, p: 1,2,3, N \quad (6)$$

The instrument has internally two current ranges: 10% and 100% range of nominal transducer current. Additionally, Smart current clamps models offer few measuring ranges, automatic clamp detection and automatic range selection.

5.1.4 Frequency measurement

Standard compliance: IEC 61000-4-30 Class A (Section 5.1)

During RECORDING with aggregation time **Interval: ≥ 10 sec** frequency reading is obtained every 10 s. The fundamental frequency output is the ratio of the number of integral cycles counted during the 10 s time clock interval, divided by the cumulative duration of the integer cycles. Harmonics and interharmonics are attenuated with digital filter in order to minimize the effects of multiple zero crossings.

The measurement time intervals are non-overlapping. Individual cycles that overlap the 10 s time clock are discarded. Each 10 s interval begin on an absolute 10 s time clock, with uncertainty as specified in section 6.2.19.

For RECORDING with aggregation time **Interval: < 10 sec** and on-line measurements, frequency reading is obtained from 10/12 cycles frequency. The frequency is ratio of 10/12 cycles, divided by the duration of the integer cycles.

Frequency measurement is *performed* on chosen **Synchronization** channel, in CONNECTION SETUP menu.

5.1.5 Modern Power measurement

Standard compliance: IEEE 1459-2010

See section 3.21.6 how to select Modern Power measurement method. Please note that instrument record all measurement (Classic and Modern), regardless of selected method. Data presentation could be changed on the instrument LCD or inside the PowerView3.0.

Instrument fully complies with power measurement defined in the latest IEEE 1459 standard. The old definitions for active, reactive, and apparent powers are valid as long as the current and voltage waveforms remained nearly sinusoidal. This is not the case today, where we have various power electronics equipment, such as Adjustable Speed Drives, Controlled Rectifiers, Cyclo-converters, Electronically Ballasted Lamps. Those represent major nonlinear and parametric loads proliferating among industrial and commercial customers. New Power theory splits power to fundamental and nonfundamental components, as shown on figure below.

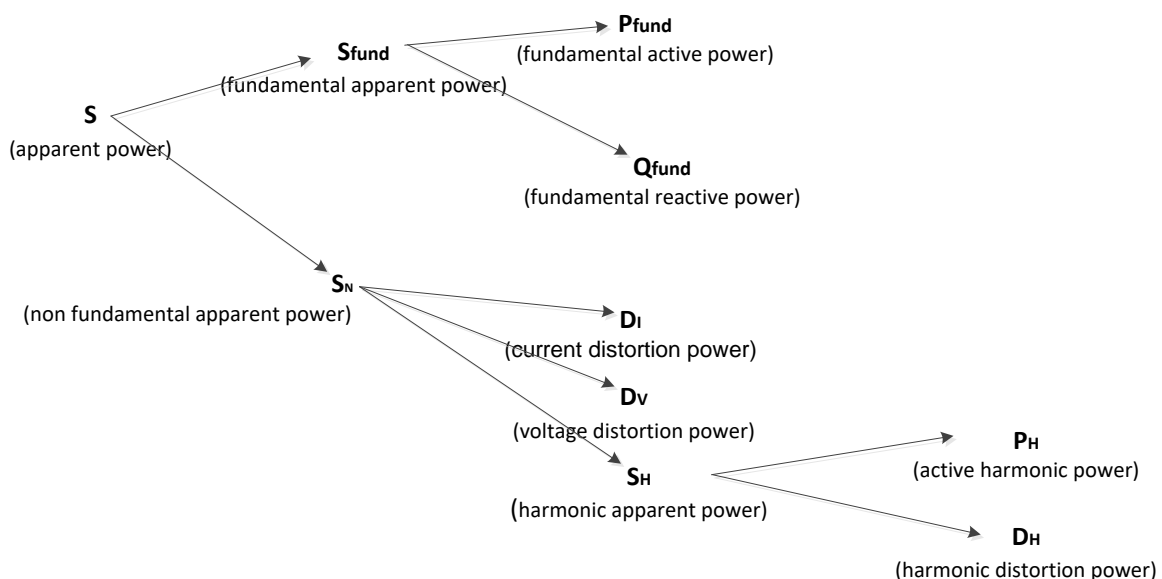

Figure 137: IEEE 1459 phase power measurement organisation (phase)

In table below summary of all power measurement is shown.

Table 127: Summary and grouping of the phase power quantities

Quantity	Combined powers	Fundamental powers	Nonfundamental Powers
Apparent (VA)	S	S_{fund}	S_N, S_H
Active (W)	P	P_{fund}	P_H
Nonactive/reactive (var)	N	Q_{fund}	D_I, D_V, D_H
Line utilization	$PF_{ind/cap}$	$DPF_{ind/cap}$	-
Harmonic pollution (%)	-	-	S_N/S_{fund}

Power measurement for three phase systems are slightly different as shown on figure below.

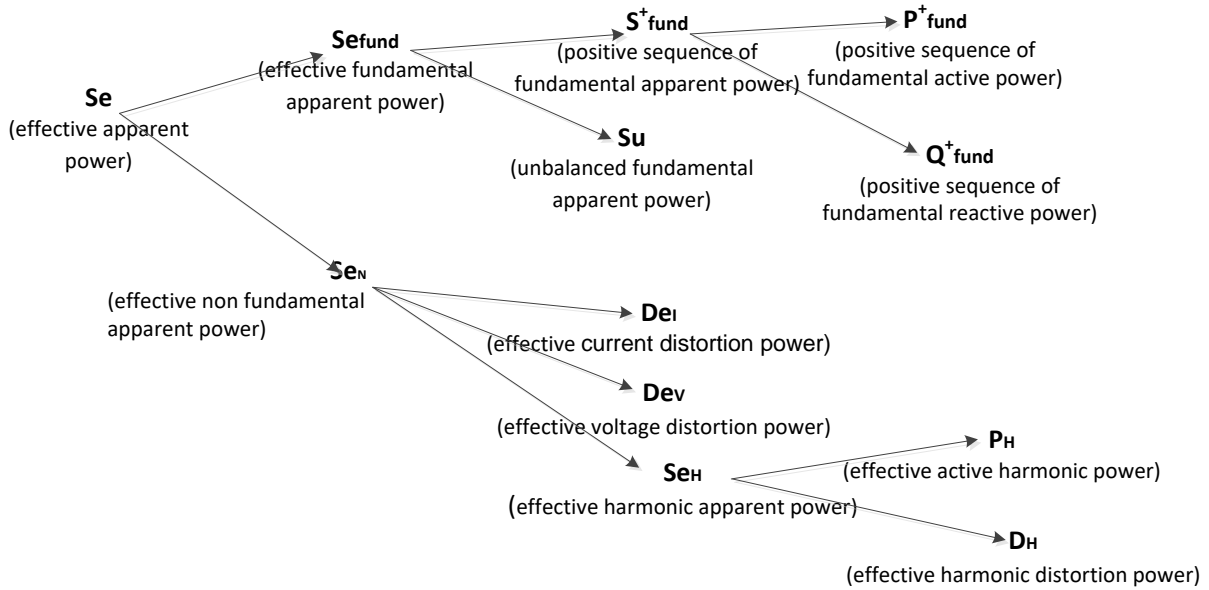

Figure 138: IEEE 1459 phase power measurement organisation (totals)

Table 128: Power summary and grouping of the total power quantities

Quantity	Combined powers	Fundamental powers	Nonfundamental Powers
Apparent (VA)	Se	Se_{fund}, S^+, Su	Se_N, Se_H
Active (W)	P	P^+_{tot}	P_H
Nonactive/reactive (var)	N	Q^+_{tot}	De_I, De_V, De_H
Line utilization	$PF_{ind/cap}$	$DPF^+_{tot ind/cap}$	-
Harmonic pollution (%)	-	-	Se_N/S_{fund}

Combined phase power measurements

Standard compliance: IEEE STD 1459-2010

All combined (fundamental + nonfundamental) active power measurements represent RMS values of the samples of instantaneous power over a 10/12-cycle time interval. Each 10/12-cycle interval is contiguous and non-overlapping.

Combined phase active power:

$$P_p = \frac{1}{N} \sum_{j=1}^N P_{p_j} = \frac{1}{N} \sum_{j=1}^N U_{p_j} * I_{p_j} \quad [\text{W}], p: 1,2,3 \quad (7)$$

Combined apparent and nonactive power, and power factor are calculated according to the following equations:

Combined phase apparent power:

$$S_p = U_p * I_p \quad [\text{VA}], p: 1,2,3 \quad (8)$$

Combined phase nonactive power:

$$N_p = \text{Sign}(Q_p) \cdot \sqrt{S_p^2 - P_p^2} \quad [\text{var}], p: 1,2,3 \quad (9)$$

Phase power factor:

$$PF_p = \frac{P_p}{S_p}, p: 1,2,3 \quad (10)$$

Total combined power measurements

Standard compliance: IEEE STD 1459-2010

Total combined (fundamental + nonfundamental) active, nonactive and apparent power and total power factor are calculated according to the following equation:

$$\text{Total active power:} \quad P_{tot} = P1 + P2 + P3 \quad [\text{W}], \quad (11)$$

$$\text{Total nonactive power:} \quad N_{tot} = N1 + N2 + N3 \quad [\text{var}], \quad (12)$$

Total apparent power (effective):

$$S_{e_{tot}} = 3 \cdot U_e \cdot I_e \quad [\text{VA}], \quad (13)$$

$$\text{Total power factor (effective):} \quad PF_{e_{tot}} = \frac{P_{tot}}{S_{e_{tot}}}. \quad (14)$$

In this formula U_e and I_e are calculated differently for three phase four wire (4W) and three phase three wire (3W) systems.

Effective voltage U_e and current I_e in 4W systems:

$$I_e = \sqrt{\frac{I_1^2 + I_2^2 + I_3^2 + I_N^2}{3}} \quad U_e = \sqrt{\frac{3 \cdot (U_1^2 + U_2^2 + U_3^2) + U_{12}^2 + U_{23}^2 + U_{31}^2}{18}} \quad (15)$$

Effective voltage U_e and current I_e in 3W systems:

$$I_e = \sqrt{\frac{I_1^2 + I_2^2 + I_3^2}{3}} \quad U_e = \sqrt{\frac{U_{12}^2 + U_{23}^2 + U_{31}^2}{9}} \quad (16)$$

Fundamental phase power measurements

Standard compliance: IEEE STD 1459-2010

All fundamental power measurements are calculated from fundamental voltages and currents obtained from harmonic analysis (see section 5.1.8 for details).

Fundamental phase active power:

$$P_{fundP} = U_{fundP} \cdot I_{fundP} \cdot \cos \varphi_{U_p - I_p} \quad [\text{W}], p: 1,2,3 \quad (17)$$

Fundamental apparent and reactive power and power factor are calculated according to the following equations:

Fundamental phase apparent power:

$$S_{fundP} = U_{fundP} \cdot I_{fundP} \quad [\text{VA}], p: 1,2,3 \quad (18)$$

Fundamental phase reactive power:

$$Q_{fundP} = U_{fundP} \cdot I_{fundP} \cdot \sin \varphi_{U_p - I_p} \quad [\text{var}], p: 1,2,3 \quad (19)$$

Phase displacement power factor:

$$DPF_p = \cos \varphi_p = \frac{P_p}{S_p}, p: 1,2,3 \quad (20)$$

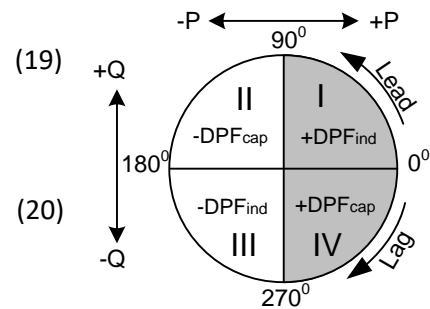

Positive sequence (total) fundamental power measurements

Standard compliance: IEEE STD 1459-2010

According to the IEEE STD 1459, positive sequence power (P^+ , Q^+ , S^+) are recognised as very important intrinsic power measurements. They are calculated according to the following equation:

Positive sequence active power:

$$P_{tot}^+ = 3 \cdot U^+ \cdot I^+ \cos \varphi^+ \quad [\text{W}], \quad (21)$$

Positive sequence reactive power:

$$Q_{tot}^+ = 3 \cdot U^+ \cdot I^+ \sin \varphi^+ \quad [\text{var}], \quad (22)$$

Positive sequence apparent power:

$$S_{tot}^+ = 3 \cdot U^+ \cdot I^+ \quad [\text{VA}], \quad (23)$$

Positive sequence power factor:

$$DPF_{tot}^+ = \frac{P_{tot}^+}{S_{tot}^+}. \quad (24)$$

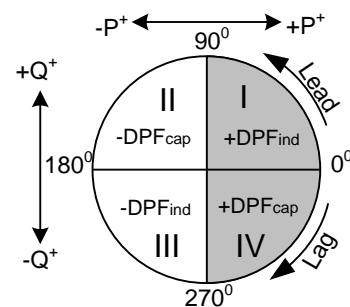

U^+ , U^0 , U^- and φ^+ are obtained from unbalance calculus. See section 5.1.11 for details.

Nonfundamental phase power measurements

Standard compliance: IEEE STD 1459-2010

Nonfundamental power measurements are measured according to following equations:

Phase nonfundamental apparent power:

$$(25)$$

$$S_{Np} = \sqrt{D_{Ip}^2 + D_{Vp}^2 + S_{Hp}^2} \quad [\text{VA}], p: 1,2,3$$

Phase current distortion power

$$D_{Ip} = S_{fundP} \cdot THD_{Ip} \quad [\text{VA}], p: 1,2,3 \quad (26)$$

Phase voltage distortion power:

$$D_{Vp} = S_{fundP} \cdot THD_{Vp} \quad [\text{var}], p: 1,2,3 \quad (27)$$

Phase harmonic apparent power

$$S_{Hp} = S_{fundP} \cdot THD_{Vp} \cdot THD_{Ip} \quad [\text{var}], p: 1,2,3 \quad (28)$$

Phase active harmonic power:

$$P_{Hp} = P_p - P_{fundP} \quad [\text{W}], p: 1,2,3 \quad (29)$$

Phase harmonic distortion power

$$D_{Hp} = \sqrt{S_{Hp}^2 - P_{Hp}^2} \quad [\text{var}], p: 1,2,3 \quad (30)$$

Total nonfundamental power measurements

Standard compliance: IEEE STD 1459-2010

Total nonfundamental power quantities are calculated according to the following equations:

Total nonfundamental effective apparent power:

$$SeN_{tot} = \sqrt{DeI_{tot}^2 + DeV_{tot}^2 + SeH_{tot}^2} \quad [\text{VA}] \quad (31)$$

Total effective current distortion power:

$$DeI_{tot} = 3 \cdot Ue_{fund} \cdot IeH \quad [\text{var}] \quad (32)$$

where:

$$IeH = \sqrt{Ie^2 - Ie_{fund}^2}$$

Total effective voltage distortion power:

$$DeV_{tot} = 3 \cdot Ue_H \cdot Ie_{fund} \quad [\text{var}] \quad (33)$$

where:

$$Ue_H = \sqrt{Ue^2 - Ue_{fund}^2}$$

Total effective apparent power:

$$SeH_{tot} = Ue_H \cdot Ie_H \quad [\text{VA}] \quad (34)$$

Total effective harmonic power:

$$PH_{tot} = PH_1 + PH_2 + PH_3 \quad [\text{W}] \quad (35)$$

where:

$$PH_1 = P_1 - P_{fund1}, PH_2 = P_2 - P_{fund2}, PH_3 = P_3 - P_{fund3}$$

Total effective distortion power

(36)

$$DeH = \sqrt{SeH^2 - PH^2} \text{ [var]}$$

Harmonic pollution

$$HP = \frac{SeN_{tot}}{Se_{fundtot}} \cdot 100 [\%] \tag{37}$$

where:

$$Se_{fundtot} = 3 \cdot U_{efund} \cdot I_{efund}$$

Load unbalance

$$LU = \frac{Su_{fund}}{S_{tot}^+} \tag{38}$$

5.1.6 Classic Vector and Arithmetic Power measurement

Standard compliance: IEC 61557-12

See section 3.21.6 how to select Modern Power measurement method. Please note that instrument record all measurement (Classic and Modern), regardless of selected method. Instrument fully complies with classic Vector and Arithmetic power measurement defined in the latest IEC 61557-12 standard (Annex A) and IEEE 1459 (Section 3.2.2.5 and 3.2.2.6). There is large number of measurement equipment installed on various points on network where this measurement algorithms are used for measurement and recording. In order to compare past measurement with current, use one of classic Power measurement. The measurements for active, reactive, and apparent powers have physical meaning as long as the current and voltage waveforms remained nearly sinusoidal. On figure below, graphical interpretation of Vector and Arithmetic power measurements are shown.

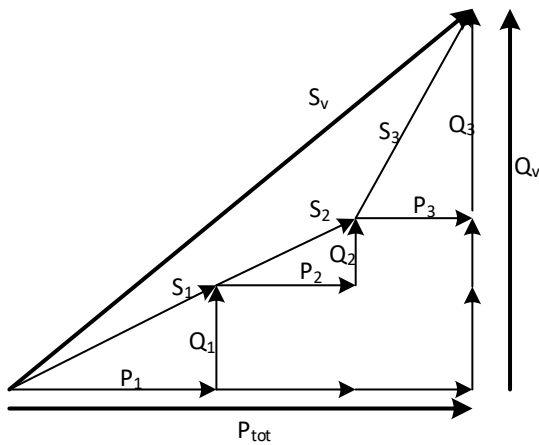

Figure 139: Vector representation of total power calculus

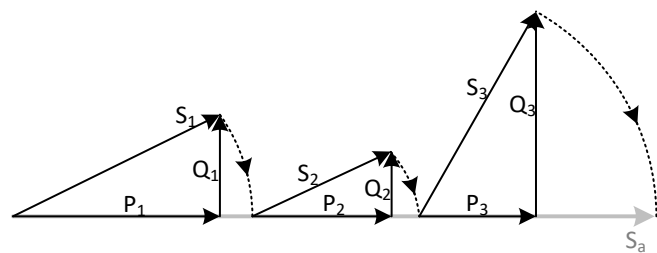

Figure 140: Arithmetic representation of total power calculus

In table below summary of all power measurement is shown.

Table 129: Summary and grouping of the phase power quantities

Quantity	Combined	Fundamental
----------	----------	-------------

	powers	powers
Apparent (VA)	S	S _{fund}
Active (W)	P	P _{fund}
Nonactive/reactive (var)	N	Q _{fund}
Line utilization	PF _{ind/cap}	DPF _{ind/cap}

Table 130: Power summary and grouping of the total power quantities

Quantity	Combined powers	Fundamental powers
Apparent (VA)	S _v	S _v _{fund}
Active (W)	P	P _{tot}
Nonactive/reactive (var)	N	Q _{tot}
Line utilization	PF _v _{ind/cap}	DPF _v _{ind/cap}

Combined phase power measurements

All Classic combined phase power measurements are identical with Modern combined phase power measurement. See 5.1.5 section Combined phase power measurements for details.

Total Vector combined power measurements

Standard compliance: IEC 61557-12 Annex A and IEEE STD 1459-2010 Section 3.2.2.6

Total Vector combined (fundamental + nonfundamental) active, nonactive and apparent power and total power factor are calculated according to the following equation:

$$\text{Total active power:} \quad P_{tot} = P_1 + P_2 + P_3 \quad [\text{W}], \quad (39)$$

$$\text{Total nonactive power (vector):} \quad N_{tot} = N_1 + N_2 + N_3 \quad [\text{var}], \quad (40)$$

$$\text{Total apparent power (vector):} \quad S_{v_{tot}} = \sqrt{P_{tot}^2 + N_{tot}^2} \quad [\text{VA}], \quad (41)$$

$$\text{Total power factor (effective):} \quad PF_{v_{tot}} = \frac{P_{tot}}{S_{v_{tot}}}. \quad (42)$$

Total Arithmetic combined power measurements

Standard compliance: IEC 61557-12 Annex A and IEEE STD 1459-2010 Section 3.2.2.5

Total Arithmetic combined (fundamental + nonfundamental) active, nonactive and apparent power and total power factor are calculated according to the following equation:

$$\text{Total active power:} \quad P_{tot} = P_1 + P_2 + P_3 \quad [\text{W}], \quad (43)$$

$$\text{Total apparent power (arithmetic):} \quad Sa_{tot} = S_1 + S_2 + S_3 \quad [\text{VA}], \quad (44)$$

$$\text{Total nonactive power (arithmetic):} \quad Na_{tot} = \sqrt{Sa_{tot}^2 - P_{tot}^2} \quad [\text{var}], \quad (45)$$

Total power factor (arithmetic):
$$PFa_{tot} = \frac{P_{tot}}{Sa_{tot}} . \quad (46)$$

Fundamental phase power measurements

Standard compliance: IEEE STD 1459-2010

All Classic fundamental phase power measurements are identical with Modern fundamental phase power measurement. See 5.1.5 section Fundamental phase power measurements for details.

Total Vector fundamental power measurements

Standard compliance: IEC 61557-12 Annex A and IEEE STD 1459-2010 Section 3.2.2.6

Total Vector fundamental active, reactive and apparent power and total displacement vector power factor are calculated according to the following equation:

Total fundamental active power:
$$P_{fundtot} = P_{fund1} + P_{fund2} + P_{fund3} \text{ [W]}, \quad (47)$$

Total fundamental reactive power (vector):
$$Q_{fundtot} = Q_{fund1} + Q_{fund2} + Q_{fund3} \text{ [var]}, \quad (48)$$

Total fundamental apparent power (vector):
$$Sv_{fundtot} = \sqrt{P_{fundtot}^2 + Q_{fundtot}^2} \text{ [VA]}, \quad (49)$$

Total displacement power factor (vector):
$$DPFv_{tot} = \frac{P_{fundtot}}{Sv_{fundtot}} . \quad (50)$$

All fundamental power measurements are calculated from fundamental voltages and currents obtained from harmonic analysis (see section 5.1.8 for details).

Total Arithmetic fundamental power measurements

Standard compliance: IEC 61557-12 Annex A and IEEE STD 1459-2010 Section 3.2.2.5

Total Arithmetic fundamental active, reactive and apparent power and total displacement arithmetic power factor are calculated according to the following equation:

Total fundamental active power:
$$P_{fundtot} = P_{fund1} + P_{fund2} + P_{fund3} \text{ [W]}, \quad (51)$$

Total apparent power (arithmetic):
$$Sa_{fundtot} = S_{fund1} + S_{fund2} + S_{3fund} \text{ [VA]}, \quad (52)$$

Total nonactive power (arithmetic):
$$Qa_{fundtot} = \sqrt{Sa_{fundtot}^2 - P_{fundtot}^2} \text{ [var]}, \quad (53)$$

Total power factor (arithmetic):
$$DPFa_{tot} = \frac{P_{fundtot}}{Sa_{fundtot}} . \quad (54)$$

All fundamental power measurements are calculated from fundamental voltages and currents obtained from harmonic analysis (see section 5.1.8 for details).

5.1.7 Energy

Standard compliance: IEC 62053-21 Class 1S, IEC 62053-23 Class 2

Energy measurement is divided in two sections: ACTIVE energy based on active power measurement and REACTIVE energy, based on fundamental reactive power measurement. Each of them has two energy counters for consumed and generated energy. Calculations are shown below:

Active energy:

$$\text{Consumed: } Ep_p^+ = \sum_{i=1}^m P_p^+(i)T(i) \text{ [kWh], } p: 1,2,3, \text{ tot} \tag{55}$$

$$\text{Generated: } Ep_p^- = \sum_{i=1}^m P_p^-(i)T(i) \text{ [kWh], } p: 1,2,3, \text{ tot}$$

Reactive energy:

$$\text{Consumed: } Eq_p^+ = \sum_{i=1}^m Q_{ind}^+(i)T(i) + \sum_{i=1}^m Q_{pCap}^+(i)T(i) \text{ [kvarh], } p: 1,2,3, \text{ tot} \tag{56}$$

$$\text{Generated: } Eq_p^- = \sum_{i=1}^m Q_{pCap}^-(i)T(i) + \sum_{i=1}^m Q_{ind}^-(i)T(i) \text{ [kvarh], } p: 1,2,3, \text{ tot}$$

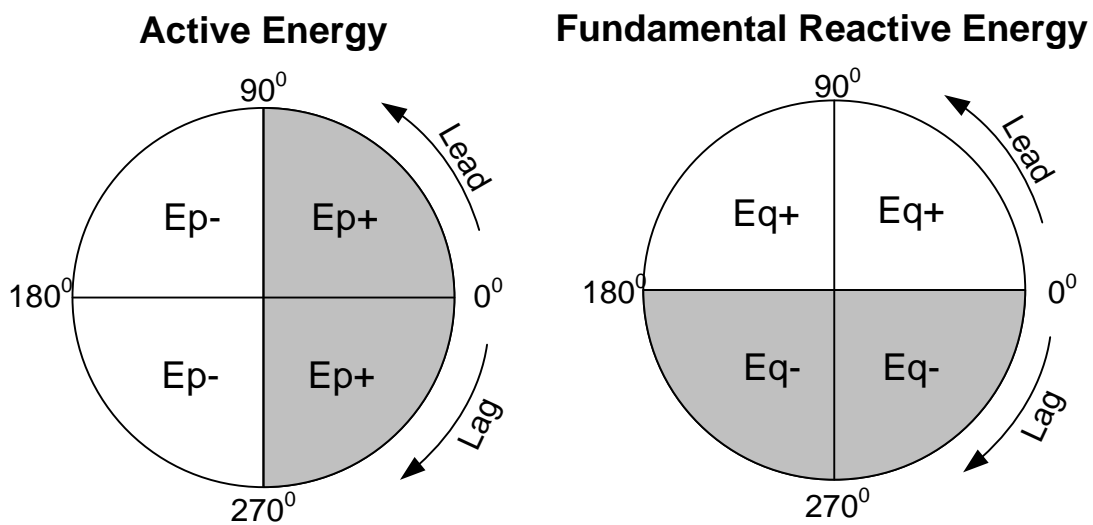

Figure 141: Energy counters and quadrant relationship

Instrument has 3 different counters sets:

1. Total counters are used for measuring energy over a complete recording. When recorder starts it sums the energy to existent state of the counters.
2. Last integration period counter measures energy during recording over last completed interval. It is calculated at end of each interval.
3. Current integration period counter measures energy during recording over current time interval.

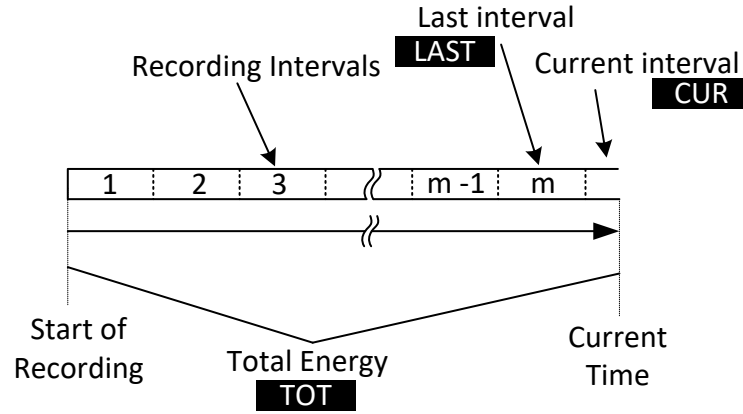

Figure 142: Instrument energy counters

5.1.8 Harmonics and interharmonics

Standard compliance: IEC 61000-4-30 Class A (Section 5.7)
IEC 61000-4-7 Class I

Calculation called fast Fourier transformation (FFT) is used to translate AD converted input signal to sinusoidal components. The following equation describes relation between input signal and its frequency presentation.

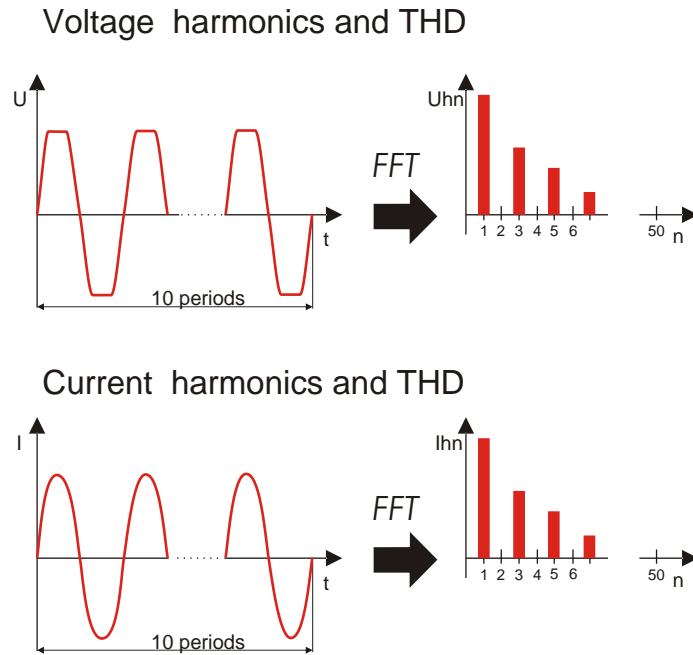

Figure 143: Current and voltage harmonics

$$u(t) = c_0 + \sum_{k=1}^{1024} c_k \sin\left(\frac{k}{10} \cdot 2\pi f_1 t + \varphi_k\right) \tag{57}$$

f_1 – frequency of signal fundamental (in example: 50 Hz)
 c_0 – DC component

- k – ordinal number (order of the spectral line) related to the frequency basis $f_{C1} = \frac{1}{T_N}$
- T_N – is the width (or duration) of the time window ($T_N = N \cdot T_1$; $T_1 = 1/f_1$). Time window is that time span of a time function over which the Fourier transformation is performed.
- c_k – is the amplitude of the component with frequency $f_{Ck} = \frac{k}{10} f_1$
- φ_k – is the phase of the component c_k
- $U_{c,k}$ – is the RMS voltage value of component c_k
- $I_{c,k}$ – is the RMS current value of component c_k

Phase voltage and current harmonics are calculated as RMS value of harmonic subgroup (*sg*): square root of the sum of the squares of the RMS value of a harmonic and the two spectral components immediately adjacent to it.

$$n^{\text{th}} \text{ voltage harmonic: } U_p h_n = \sqrt{\sum_{k=-1}^1 U_{C,(10-n)+k}^2} \quad p: 1,2,3 \quad (58)$$

$$n^{\text{th}} \text{ current harmonic: } I_p h_n = \sqrt{\sum_{k=-1}^1 I_{C,(10-n)+k}^2} \quad p: 1,2,3 \quad (59)$$

Total harmonic distortion is calculated as ratio of the RMS value of the harmonic subgroups to the RMS value of the subgroup associated with the fundamental:

$$\text{Total voltage harmonic distortion: } THD_{U_p} = \sqrt{\sum_{n=2}^{40} \left(\frac{U_p h_n}{U_p h_1} \right)^2}, \quad p: 1,2,3 \quad (60)$$

$$\text{Total current harmonic distortion: } THD_{I_p} = \sqrt{\sum_{n=2}^{40} \left(\frac{I_p h_n}{I_p h_1} \right)^2}, \quad p: 1,2,3 \quad (61)$$

Spectral component between two harmonic subgroups are used for interharmonics assessment. Voltage and current interharmonic subgroup of n -th order is calculated using RSS (root sum square) principle:

$$n^{\text{th}} \text{ voltage interharmonic: } U_p i h_n = \sqrt{\sum_{k=2}^8 U_{C,(10-n)+k}^2} \quad p: 1,2,3 \quad (62)$$

$$n^{\text{th}} \text{ current interharmonic: } I_p i h_n = \sqrt{\sum_{k=2}^8 I_{C,(10-n)+k}^2} \quad p: 1,2,3 \quad (63)$$

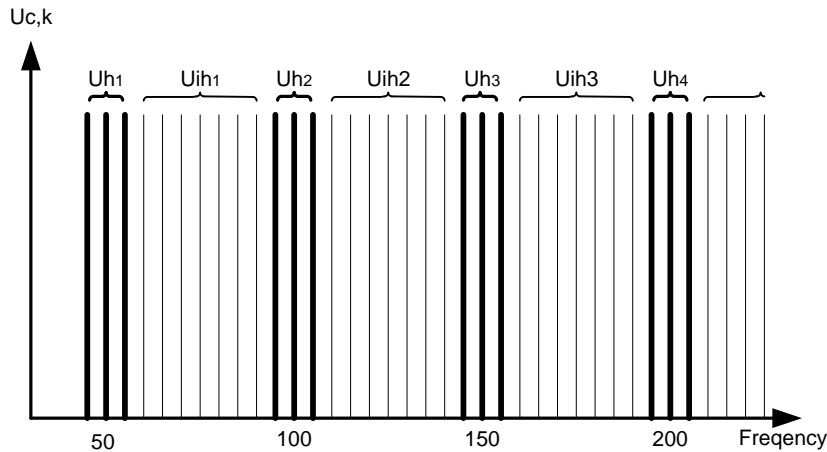

Figure 144: Illustration of harmonics / interharmonics subgroup for 50 Hz supply

The K factor is a factor that is developed to indicate the amount of harmonics that the load generates. The K rating is extremely useful when designing electric systems and sizing components. It is calculated as:

$$\text{K - factor: } K_p = \frac{\sum_{n=1}^{50} (I_p h_n \cdot n)^2}{\sum_{n=1}^{50} I_p h_n^2}, \quad p: 1,2,3 \quad (64)$$

5.1.9 Signalling

Standard compliance: IEC 61000-4-30 Class A (Section 5.10)

Signalling voltage is calculated on a FFT spectrum of a 10/12-cycle interval. Value of mains signalling voltage is measured as:

- RMS value of a single frequency bin if signalling frequency is equal to spectral bin frequency, or
- RSS value of four neighbouring frequency bins if signalling frequency differs from the power system bin frequency (for example, a ripple control signal with frequency value of 218 Hz in a 50 Hz power system is measured based on the RMS values of 210, 215, 220 and 225 Hz bins).

Mains signalling value calculated every 10/12 cycle interval are used in alarm and recording procedures. However, for EN50160 recording, results are aggregated additionally on 3 s intervals. Those values are used for confronting with limits defined in standard.

5.1.10 Flicker

Standard compliance: IEC 61000-4-30 Class A (Section 5.3)
IEC 61000-4-15 Class F3

Flicker is a visual sensation caused by unsteadiness of a light. The level of the sensation depends on the frequency and magnitude of the lighting change and on the observer. Change of a lighting flux can be correlated to a voltage envelope on figure below.

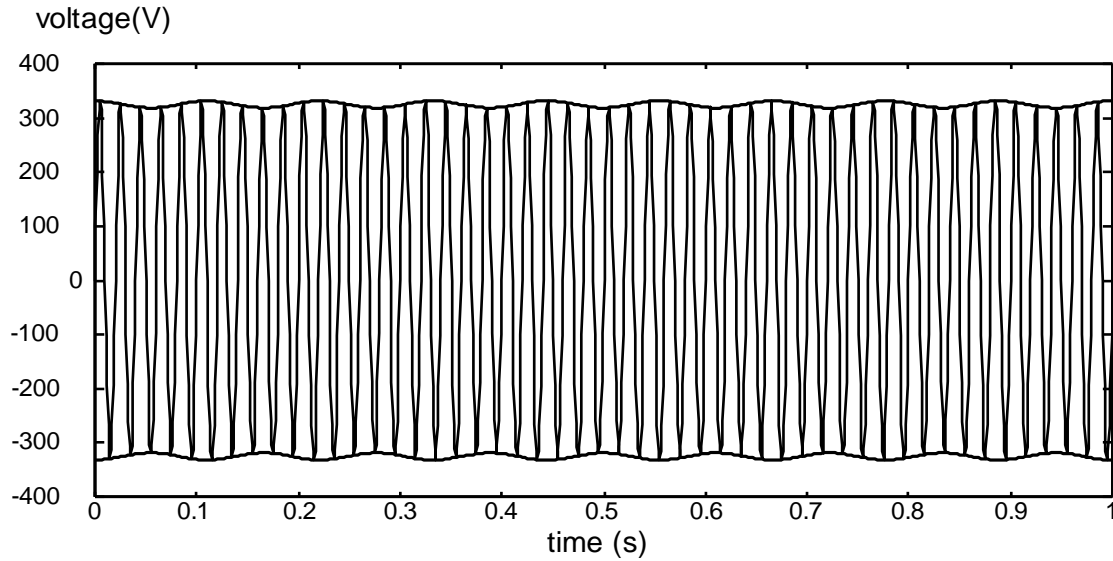

Figure 145: Voltage fluctuation

Flickers are measured in accordance with standard IEC 61000-4-15. Standard defines the transform function based on a 230 V / 60 W and 120 V / 60 W lamp-eye-brain chain response. That function is a base for flicker meter implementation and is presented on figure below.

P_{st1min} – is a short flicker estimation based on 1-minute interval. It is calculated to give quick preview of 10 minutes short term flicker.

P_{st} – 10 minutes, short term flicker is calculated according to IEC 61000-4-15

P_{lt} – 2 hours, long term flicker is calculated according to the following equation:

$$P_{lp} = \sqrt[3]{\frac{\sum_{i=1}^N Pst_i^3}{N}} \quad p: 1,2,3 \quad (65)$$

5.1.11 Voltage and current unbalance

Standard compliance: IEC 61000-4-30 Class A (Section 5.7)

The supply voltage unbalance is evaluated using the method of symmetrical components. In addition to the positive sequence component U^+ , under unbalanced conditions there also exists negative sequence component U^- and zero sequence component U_0 . These quantities are calculated according to the following equations:

$$\begin{aligned} \vec{U}^+ &= \frac{1}{3}(\vec{U}_1 + a\vec{U}_2 + a^2\vec{U}_3) \\ \vec{U}_0 &= \frac{1}{3}(\vec{U}_1 + \vec{U}_2 + \vec{U}_3), \\ \vec{U}^- &= \frac{1}{3}(\vec{U}_1 + a^2\vec{U}_2 + a\vec{U}_3), \end{aligned} \quad (66)$$

where $a = \frac{1}{2} + \frac{1}{2}j\sqrt{3} = 1e^{j120^\circ}$.

For unbalance calculus, instrument use the fundamental component of the voltage input signals (U_1 , U_2 , U_3), measured over a 10/12-cycle time interval.

The negative sequence ratio u^- , expressed as a percentage, is evaluated by:

$$u^- (\%) = \frac{U^-}{U^+} \times 100 \quad (67)$$

The zero-sequence ratio u^0 , expressed as a percentage, is evaluated by:

$$u^0 (\%) = \frac{U^0}{U^+} \times 100 \quad (68)$$

Note: In 3W systems zero sequence components U_0 and I_0 are by definition zero.

The supply current unbalance is evaluated in same fashion.

5.1.12 Under-deviation and over-deviation

Voltage Under-deviation (U_{Under}) and Over-deviation (U_{Over}) measurement method: Standard compliance: IEC 61000-4-30 Class A (Section 5.12)

Basic measurement for the Under-deviation and Over-deviation is RMS voltage magnitude measured over a 10/12-cycle time interval. Each RMS voltage *magnitude* (i) obtained through recording campaign is compared to nominal voltage U_{Nom} from which we express two vectors according to the formulas below:

$$U_{Under,i} = \begin{cases} U_{RMS(10/12),i} & \text{if } U_{RMS(10/12)} \leq U_{Nom} \\ U_{Nom} & \text{if } U_{RMS(10/12)} > U_{Nom} \end{cases} \quad (69)$$

$$U_{Over,i} = \begin{cases} U_{RMS(10/12),i} & \text{if } U_{RMS(10/12)} \geq U_{Nom} \\ U_{Nom} & \text{if } U_{RMS(10/12)} < U_{Nom} \end{cases} \quad (70)$$

Aggregation is performed on the end of recording interval as:

$$U_{Under} = \frac{U_{Nom} - \sqrt{\frac{\sum_{i=1}^n U_{Under,i}^2}{n}}}{U_{Nom}} [\%] \quad (71)$$

$$U_{Over} = \frac{U_{Nom} - \sqrt{\frac{\sum_{i=1}^n U_{Over,i}^2}{n}}}{U_{Nom}} [\%] \quad (72)$$

Under-deviation and over-deviation parameters may be useful when it is important to avoid, for example, having sustained under-voltages being cancelled in data by sustained over-voltages.

Note: Under-deviation and Over-deviation parameters are always positive values.

5.1.13 Voltage events

Measurement method

Standard compliance: IEC 61000-4-30 Class A (Section 5.4)

The basic measurement for event is $U_{Rms(1/2)}$. $U_{Rms(1/2)}$ is value of the RMS voltage measured over 1 cycle, commencing at a fundamental zero crossing and refreshed each half-cycle.

The cycle duration for $U_{Rms(1/2)}$ depends on the frequency, which is determined by the last 10/12-cycle frequency measurement. The $U_{Rms(1/2)}$ value includes, by definition, harmonics, interharmonics, mains signalling voltage, etc.

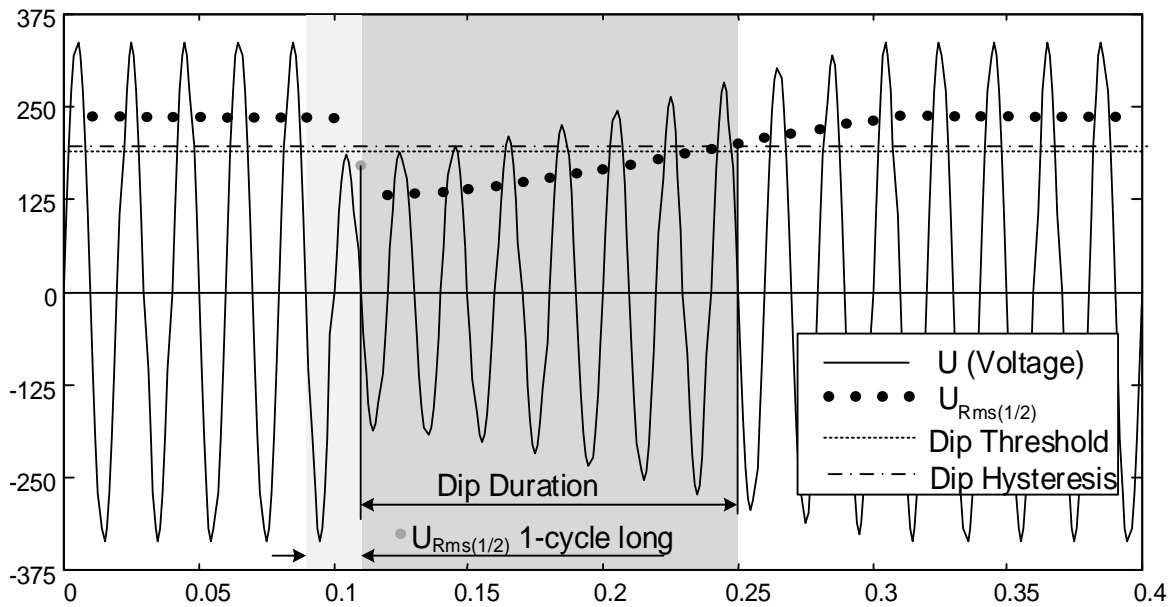

Figure 146: $U_{Rms(1/2)}$ 1-cycle measurement

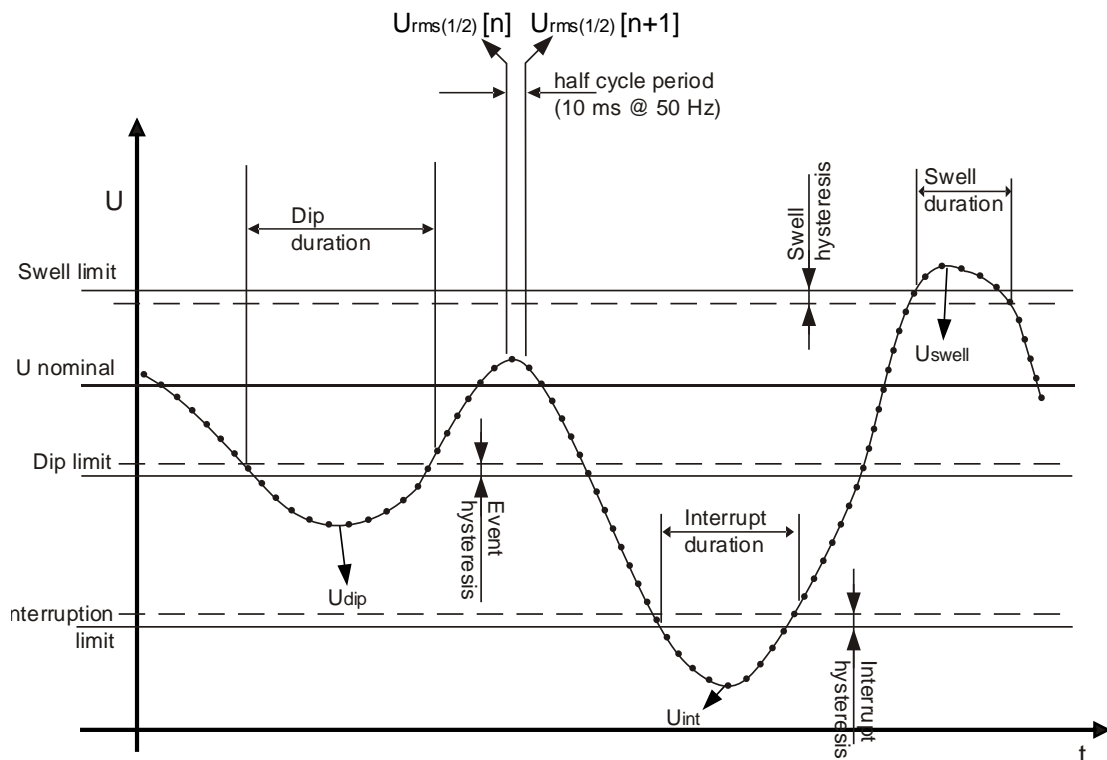

Figure 147: Voltage events definition

Voltage dip

Standard compliance: IEC 61000-4-30 Class A (Sections 5.4.1 and 5.4.2)

The **Dip Threshold** is a percentage of Nominal voltage defined in CONNECTION menu. The Dip Threshold and Hysteresis can be set by the user according to the use. **Dip Hysteresis** is difference in magnitude between the Dip start and Dip end thresholds. Instrument event evaluation in Event table screen depends on Connection type:

- On single-phase system (Connection type: 1W), a voltage dip begins when the $U_{Rms(1/2)}$ voltage falls below the dip threshold, and ends when the $U_{Rms(1/2)}$ voltage is equal to or above the dip threshold plus the hysteresis voltage.
- On poly-phase systems (Connection type: 2W, 3W, 4W, Open Delta) two different views can be used for evaluation simultaneously:
 - Group view  with selected **ALL INT** view (in compliance with IEC 61000-4-30 Class A): a dip begins when the $U_{Rms(1/2)}$ voltage of one or more channels is below the dip threshold and ends when the $U_{Rms(1/2)}$ voltage on all measured channels is equal to or above the dip threshold plus the hysteresis voltage.
 - Phase view **Ph.** (for troubleshooting): a voltage dip begins when the $U_{Rms(1/2)}$ voltage of one channel falls below the dip threshold, and ends when the $U_{Rms(1/2)}$ voltage is equal to or above the dip threshold plus the hysteresis voltage, on the same phase.



Figure 148: Voltage dip related screens on the instrument

A voltage dip is characterized by following data: **Dip Start time**, **Level (U_{Dip})** and **Dip duration**:

- U_{Dip} – residual dip voltage, is the lowest $U_{Rms(1/2)}$ value measured on any channel during the dip. It is shown in **Level** column in the Event Table on the instrument.
- The **Dip Start time** is time stamped with the time of the start of the $U_{Rms(1/2)}$ of the channel that initiated the event. It is shown in **START** column in the Event Table on the instrument. The Dip End time is time stamped with the time of the end of the $U_{Rms(1/2)}$ that ended the event, as defined by the threshold.
- The **Dip Duration** is the time difference between the Dip Start time and the Dip End time. It is shown in **Duration** column in the Event Table on the instrument.

Voltage swell

Standard compliance: IEC 61000-4-30 Class A (Sections 5.4.1 and 5.4.3)

The **Swell Threshold** is a percentage of nominal voltage defined in CONNECTION menu. The swell threshold can be set by the user according to the use. **Swell Hysteresis** is difference in magnitude between the Swell start and Swell end thresholds. Instrument event evaluation in Event table screen depends on Connection type:

- On single-phase system (Connection type: 1W), a voltage swell begins when the $U_{Rms(1/2)}$ voltage rises above the swell threshold, and ends when the $U_{Rms(1/2)}$ voltage is equal to or below the swell threshold plus the hysteresis voltage.
- On poly-phase systems (Connection type: 2W, 3W, 4W, Open Delta) two different view can be used for evaluation simultaneously:

- Group view  with selected **ALL INT** view: A swell begins when the $U_{Rms(1/2)}$ voltage of one or more channels is above the swell threshold and ends when the $U_{Rms(1/2)}$ voltage on all measured channels is equal to or below the swell threshold plus the hysteresis voltage.
- Phase view **Ph.:** A swell begins when the $U_{Rms(1/2)}$ voltage of one channel rises above the swell threshold, and ends when the $U_{Rms(1/2)}$ voltage is equal to or below the swell threshold plus the hysteresis voltage, on the same phase.

A voltage swell is characterized by following data: **Swell Start time**, Level (U_{Swell}) and **Swell duration**:

- U_{Swell} – maximum swell magnitude voltage, is the largest $U_{Rms(1/2)}$ value measured on any channel during the swell. It is shown in **Level** column in the Event Table on the instrument.
- The **Swell Start time** is time stamped with the time of the start of the $U_{Rms(1/2)}$ of the channel that initiated the event. It is shown in **START** column in the Event Table on the instrument. The Swell End time is time stamped with the time of the $U_{Rms(1/2)}$ that ended the event, as defined by the threshold.
- The **Duration** of a voltage swell is the time difference between the beginning and the end of the swell. It is shown in **Duration** column in the Event Table on the instrument.

Voltage interrupt

Standard compliance: IEC 61000-4-30 Class A (Section 5.5)

Measuring method for voltage interruptions detection is same as for dips and swells, and is described in previous sections.

The **Interrupt Threshold** is a percentage of nominal voltage defined in CONNECTION menu. **Interrupt Hysteresis** is difference in magnitude between the Interrupt start and Interrupt end thresholds. The interrupt threshold can be set by the user according to the use. Instrument event evaluation in Event table screen depends on Connection type:

- On single-phase system (1W), a voltage interruption begins when the $U_{Rms(1/2)}$ voltage falls below the voltage interruption threshold and ends when the $U_{Rms(1/2)}$ value is equal to, or greater than, the voltage interruption threshold plus the hysteresis
- On poly-phase systems (2W, 3W, 4W, Open Delta) two different view can be used for evaluation simultaneously:
 - Group view  with selected **ALL INT** view: a voltage interruption begins when the $U_{Rms(1/2)}$ voltages of all channels fall below the voltage interruption threshold and ends when the $U_{Rms(1/2)}$ voltage on any one channel is equal to, or greater than, the voltage interruption threshold plus the hysteresis.
 - Phase view **Ph.:** a voltage interrupt begins when the $U_{Rms(1/2)}$ voltage of one channel fall below the interrupt threshold, and ends when the $U_{Rms(1/2)}$ voltage is equal to or above the interrupt threshold plus the hysteresis voltage, on the same phase.

EVENT SETUP		15:12		EVENTS		02:48	
Nominal voltage L-N = 230V				Date 01.01.2000			
Swell Threshold	110.0%	(253.0V)	No	L	START	T	Level
Swell Hysteresis	2%		3	1 2 3	02:22:41.257	I	0.06
Dip Threshold	90.0%	(207.0V)	4	1 2 3	02:39:47.254	I	0.06
Dip Hysteresis	2%						0h00m7.983s
Interrupt Threshold	5.0%	(11.5V)					0h00m7.987s
Interrupt Hysteresis	2%						
HELP				Ph.		ALL INT	
				STAT			

Figure 149: Voltage interrupts related screens on the instrument

A voltage interrupt is characterized by following data: **Interrupt Start time**, **Level (U_{Int})** and **Interrupt Duration**:

- U_{Int} – minimum interrupt magnitude voltage, is the lower $U_{\text{Rms}(1/2)}$ value measured on any channel during the interrupt. It is shown in **Level** column in the Event Table on the instrument.
- The **Interrupt Start time** of an interrupt is time stamped with the time of the start of the $U_{\text{Rms}(1/2)}$ of the channel that initiated the event. It is shown in **START** column in the Event Table on the instrument. The Interrupt End time of the interrupt is time stamped with the time of the end of the $U_{\text{Rms}(1/2)}$ that ended the event, as defined by the threshold.
- The **Interrupt Duration** is the time difference between the beginning and the end of the interrupt. It is shown in **Duration** column in the Event Table on the instrument.

5.1.14 Alarms

Generally, alarm can be seen as an event on arbitrary quantity. Alarms are defined in alarm table (see section 3.21.3 for alarm table setup). The basic measurement time interval for: voltage, current, active, nonactive and apparent power, harmonics and unbalance alarms is a 10/12-cycle time interval.

Each alarm has attributes described in table below. Alarm occurs when 10/12-cycle measured value on phases defined as **Phase**, cross **Threshold value** according to defined **Trigger slope**, minimally for **Minimal duration** value.

Table 131: Alarm definition parameters

Quantity	<ul style="list-style-type: none"> • Voltage • Current • Frequency • Active, nonactive and apparent power • Harmonics and interharmonics • Unbalance • Flickers • Signalling
Phase	L1, L2, L3, L12, L23, L31, All, Tot, N
Trigger slope	< - Fall , > - Rise
Threshold value	[Number]
Minimal duration	200ms ÷ 10min

Each captured alarm is described by the following parameters:

Table 132: Alarm signatures

Date	Date when selected alarm has occurred
Start	Alarm start time - when first value cross threshold.
Phase	Phase on which alarm occurred
Level	Minimal or maximal value in alarm
Duration	Alarm duration

5.1.15 Rapid voltage changes (RVC)

Standard compliance: IEC 61000-4-30 Class A (Section 5.11)

Rapid Voltage Change (RVC) is generally speaking an abrupt transition between two “steady state” RMS voltage levels. It is considered as event, (similar to dip or swell) with start time and duration between steady state levels. However, those steady state levels does not exceed dip or swell threshold.

RVC event detection

Instrument RVC event detection implementation strictly follows IEC 61000-4-30 standard requirements. It begins with finding a voltage steady-state. RMS voltage is in a steady-state condition if 100/120 $U_{Rms(1/2)}$ values remain within an RVC threshold (this value is set by the user in MEASUREMENT SETUP → RVC Setup screen) from the arithmetic mean of those 100/120 $U_{Rms(1/2)}$ values. Every time a new $U_{Rms(1/2)}$ value is available, the arithmetic mean of the previous 100/120 $U_{Rms(1/2)}$ values, including the new value, is calculated. If a new $U_{Rms(1/2)}$ value crosses RVC threshold, RVC event is detected. After detection instruments wait for 100/120 half cycles, before searching for next voltage steady-state. If a voltage dip or voltage swell is detected during an RVC event, then the RVC event is discarded because the event is not an RVC event.

RVC event characterisation

An RVC event is characterized by four parameters: start time, duration, ΔU_{max} and ΔU_{ss} .

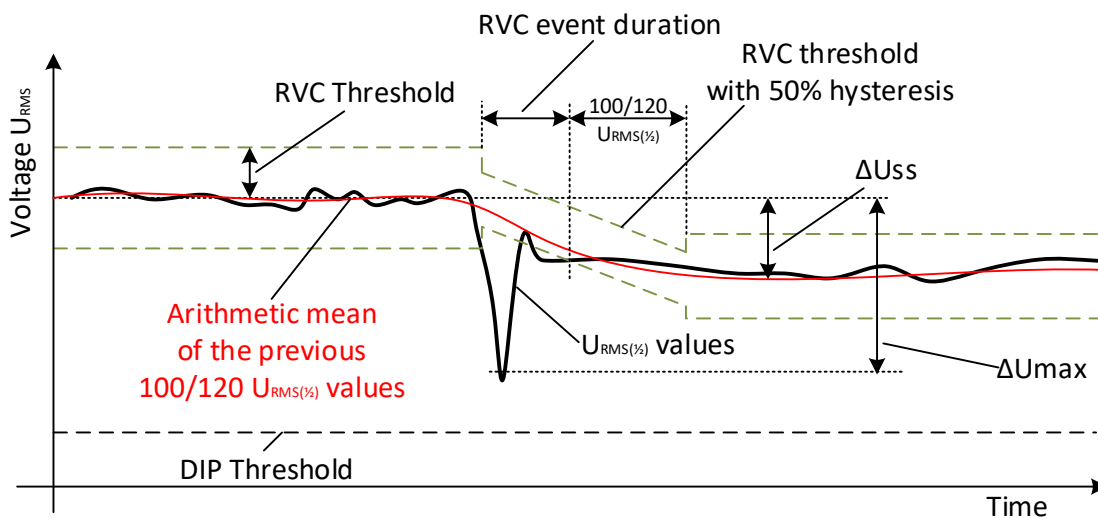

Figure 61: RVC event description

- **Start time** of an RVC event is time stamp when $U_{Rms(1/2)}$ value cross RVC threshold level
- RVC event **duration** is 100/120 half cycles shorter than the duration between adjacent steady states voltages.
- **ΔU_{max}** is the maximum absolute difference between any of the $U_{Rms(1/2)}$ values during the RVC event and the final arithmetic mean 100/120 $U_{Rms(1/2)}$ value just prior to the RVC event. For poly-phase systems, the ΔU_{max} is the largest ΔU_{max} on any channel.
- **ΔU_{ss}** is the absolute difference between the final arithmetic mean 100/120 $U_{Rms(1/2)}$ value just prior to the RVC event and the first arithmetic mean 100/120 $U_{Rms(1/2)}$ value after the RVC event. For poly-phase systems, the ΔU_{ss} is the largest ΔU_{ss} on any channel.

5.1.16 Data aggregation in GENERAL RECORDING

Standard compliance: IEC 61000-4-30 Class A (Section 4.5)

Time aggregation period (IP) during recording is defined with parameter Interval: x min in GENERAL RECORDER menu.

A new recording interval commence at real time clock tick (10 minutes ± half cycle, for Interval: 10 min) and it last until next real time clock plus time needed to finish current 10/12 cycle measurement. In the same time new measurement is started, as shown on next figure. The data for the IP time interval are aggregated from 10/12-cycle time intervals, according to the figure below. The aggregated interval is tagged with the absolute time. The time tag is the time at the conclusion of the interval. There is overlap, during recording, as illustrated on figure below.

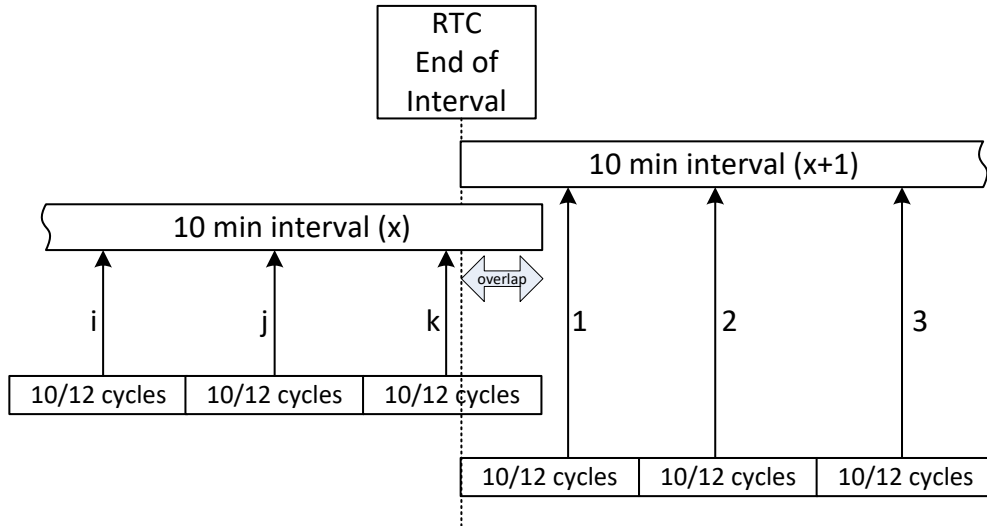

Figure 151: Synchronization and aggregation of 10/12 cycle intervals

Depending from the quantity, for each aggregation interval instrument computes average, minimal, maximal and/or active average value, this can be RMS (root means square) or arithmetical average. Equations for both averages are shown below.

RMS average
$$A_{RMS} = \sqrt{\frac{1}{N} \sum_{j=1}^N A_j^2} \tag{73}$$

Where:

A_{RMS} – quantity average over given aggregation interval

A – 10/12-cycle quantity value

N – number of 10/12 cycles measurements per aggregation interval.

Arithmetic average:
$$A_{avg} = \frac{1}{N} \sum_{j=1}^N A_j \tag{74}$$

Where:

A_{avg} – quantity average over given aggregation interval

A – 10/12-cycle quantity value

N – number of 10/12 cycles measurements per aggregation interval.

In the next table averaging method for each quantity is specified:

Table 133: Data aggregation methods

Group	Value	Aggregation method	Recorded values
Voltage	U_{Rms}	RMS average	Min, Avg, AvgOn, Max
	THD_U	RMS average	AvgOn, Max

	CF _U	RMS average	Min, Avg, Max
Current	I _{Rms}	RMS average	Min, Avg, AvgOn, Max
	THD _I	RMS average	Avg, AvgOn, Max
	CF _I	RMS average	Min, Avg, AvgOn, Max
Frequency	f(10s)	-	AvgOn
	f(200ms)	RMS average	Min, AvgOn, Max
Power	Combined	Arithmetic average	Min, Avg, AvgOn, Max
	Fundamental	Arithmetic average	Min, Avg, AvgOn, Max
	Nonfundamental	Arithmetic average	Min, Avg, AvgOn, Max
Unbalance	U ⁺	RMS	Min, Avg, AvgOn, Max
	U ⁻	RMS	Min, Avg, AvgOn, Max
	U ⁰	RMS	Min, Avg, AvgOn, Max
	u-	RMS	Min, Avg, AvgOn, Max
	u0	RMS	Min, Avg, AvgOn, Max
	I ⁺	RMS	Min, Avg, AvgOn, Max
	I ⁻	RMS	Min, Avg, AvgOn, Max
	I ⁰	RMS	Min, Avg, AvgOn, Max
	i-	RMS	Min, Avg, AvgOn, Max
	i0	RMS	Min, Avg, AvgOn, Max
Harmonics	DC, Uh _{0÷50}	RMS	Avg, Max
	DC, Ih _{0÷50}	RMS	Avg, AvgOn, Max,
Interharmonics	Uh _{0÷50}	RMS	Avg, Max
	Ih _{0÷50}	RMS	Avg, AvgOn, Max
Signalling	U _{Sig}	RMS	Min, Avg, AvgOn, Max

An *active average* value is calculated upon the same principle (arithmetic or RMS) as average value, but taking in account only measurement where measured value is not zero:

$$\text{RMS active average} \quad A_{RMSact} = \sqrt{\frac{1}{M} \sum_{j=1}^M A_j^2}; M \leq N \quad (75)$$

Where:

A_{RMSact} – quantity average over active part of given aggregation interval,

A – 10/12-cycle quantity value marked as “active”,

M – number of 10/12 cycles measurements with active (non zero) value.

$$\text{Arithmetic active average:} \quad A_{avgact} = \frac{1}{M} \sum_{j=1}^M A_j; M \leq N \quad (76)$$

Where:

A_{avgact} – quantity average over active part of given aggregation interval,

A – 10/12-cycle quantity value in “active” part of interval,

M – number of 10/12 cycles measurements with active (non zero) value.

Difference between standard average (Avg) and active average (AvgOn)

Example: Suppose we measure current on AC motor which is switched on for 5 min every 10 minutes. Motor consumes 100A. User set recording interval to 10 minutes.

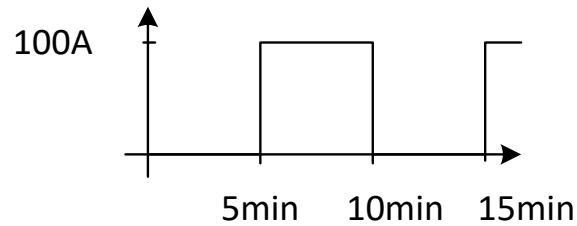

Figure 152: Avg vs. Avgon, switching load current

After 10 minutes values will be:

I_{rms} (rms average) = 50A

I_{rms} (rms AvgOn) = 100A

AvgOn considers only those measurements where current is greater than zero.

Power and energy recording

Active power is aggregated into two different quantities: import (positive-consumed P+) and export (negative-generated P-). Nonactive power and power factor are aggregated into four parts: positive inductive (i+), positive capacitive (c+), negative inductive (i-) and negative capacitive (c-).

Consumed/generated and inductive/capacitive phase/polarity diagram is shown on figure below:

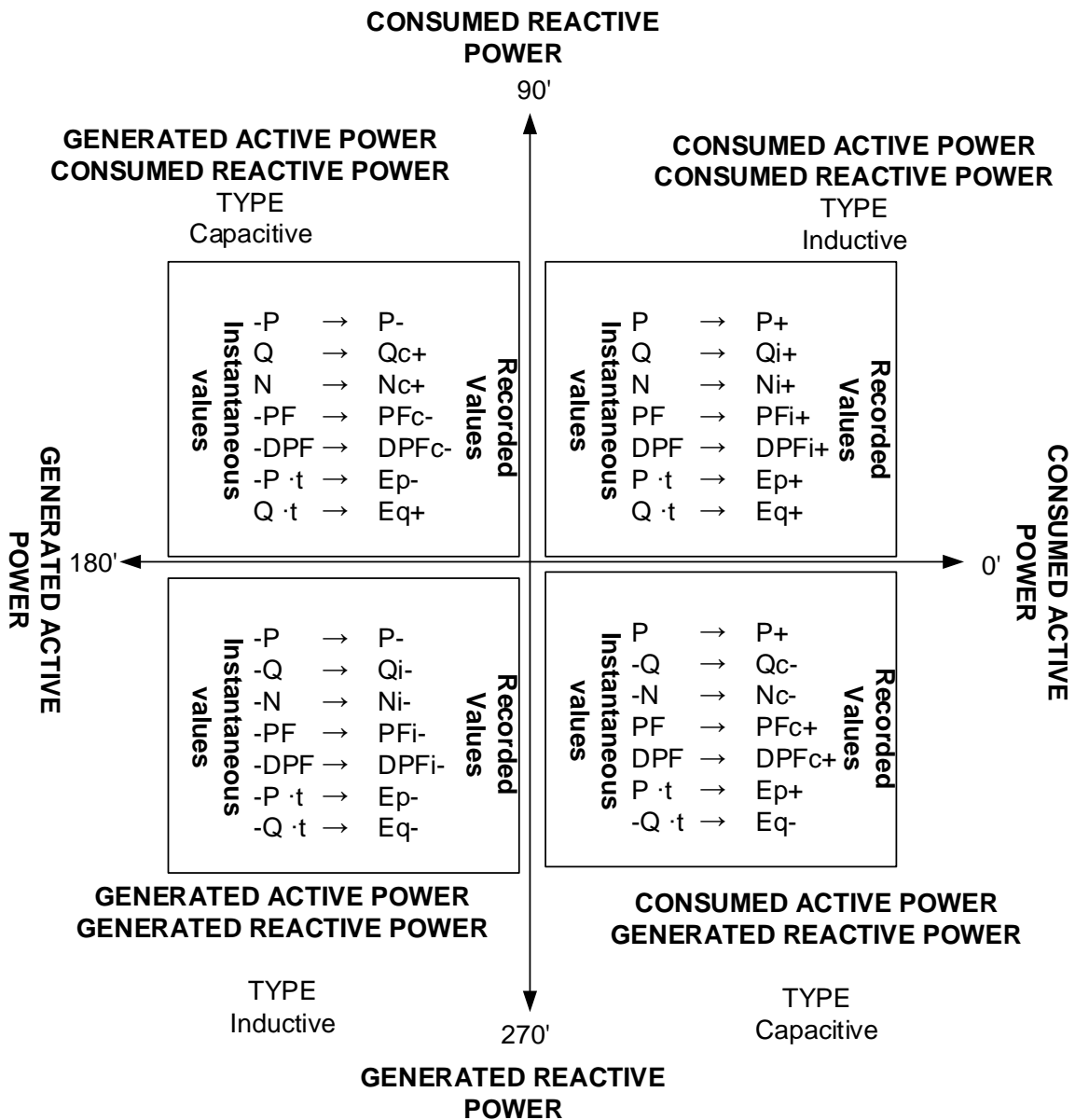

Figure 153: Consumed/generated and inductive/capacitive phase/polarity diagram

5.1.17 Flagged data

Standard compliance: IEC 61000-4-30 Class A (Section 4.7)

During a dip, swell, or interruption, the measurement algorithm for other parameters (for example, frequency measurement) might produce an unreliable value. The flagging concept avoids counting a single event more than once in different parameters (for example, counting a single dip as both a dip and a voltage variation), and indicates that an aggregated value might be unreliable. Flagging is only triggered by dips, swells, and interruptions. The detection of dips and swells is dependent on the threshold selected by the user, and this selection will influence which data are "flagged".

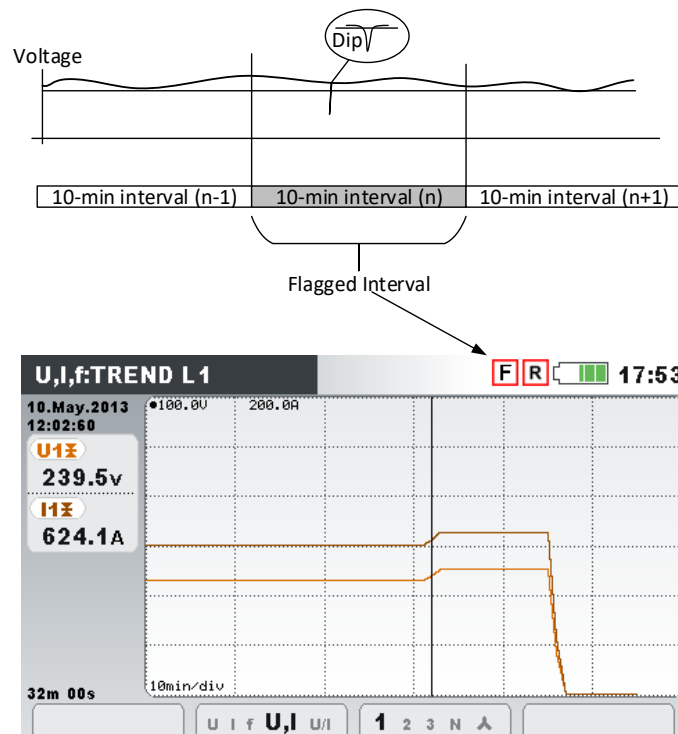



Figure 154: Flagging data indicate that aggregated value might be unreliable

5.1.18 Waveform snapshot

During measurement campaign Power Master XT has the ability to take waveform snapshot. This is particularly useful for storing temporary characteristics or network behaviour. Snapshot stores all network signatures and waveform samples for 10/12 cycles. Using MEMORY LIST function (see 3.19) or with PowerView v3.0 software, user can observe stored data. Waveform snapshot is captured by starting GENERAL recorder or by pressing  for 3 seconds in any of MEASUREMENTS sub screens.



Long press on  triggers WAVEFORM SNAPSHOT. Instrument will record all measured parameters into file.

Note: WAVEFORM SNAPSHOT is automatically created at the start of GENERAL RECORDER.

5.1.19 Waveform recorder

Waveform recorder can be used in order to capture waveform of particular network event: such as voltage event, inrush or alarm. In waveform record samples of voltage and current are stored for given duration. Waveform recorder starts when the pre-set trigger occurs. Storage buffer is divided into pre-trigger and post-trigger buffers. Pre and post-trigger buffers are composed of waveform snapshots taken before and after trigger occurrence, as shown on following figure.

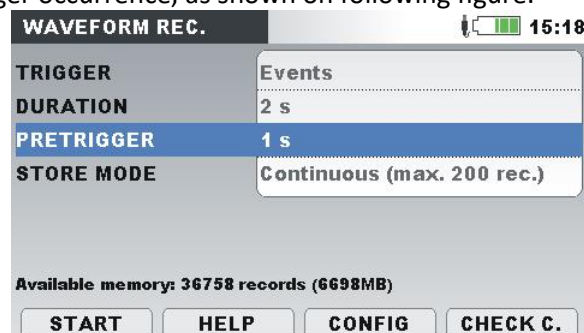

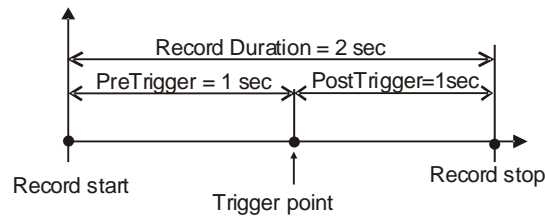

Figure 155: Triggering and pre-triggering description

Several trigger sources are possible:

- Manual trigger - user manually triggers waveform recording.
- Voltage events – instrument starts waveform recorder when voltage event occur. Voltage events are set up in EVENT SETUP menu (see 3.21.2 for details), where user defines threshold limits for each event type: Dip, Swell and Interrupt. Each time event occurs, waveform recorder starts recording. Instrument then capture $U_{Rms(1/2)}$ and $I_{Rms(1/2)}$ values into RxxxxINR.REC file and waveform samples for all voltages and currents channels into RxxxxWAV.REC file. If parameter PRETRIGGER is greater than zero, then recoding will start prior the event for defined time, and will finish when record DURATION length is reached. On following figure voltage dip is shown, where voltage drops from nominal value to the almost zero. When voltage drops below dip threshold, it triggers recorder, which capture voltage and current samples from one second before dip to one second after dip occurs. Note that if during this time period another event occurs, (as interrupt on figure below, for example) it will be captured within the same file. In case where voltage event last for longer time, new recording will start after first record is finished, soon as any new event occurs (voltage ramp-up event, shown as example on figure below).

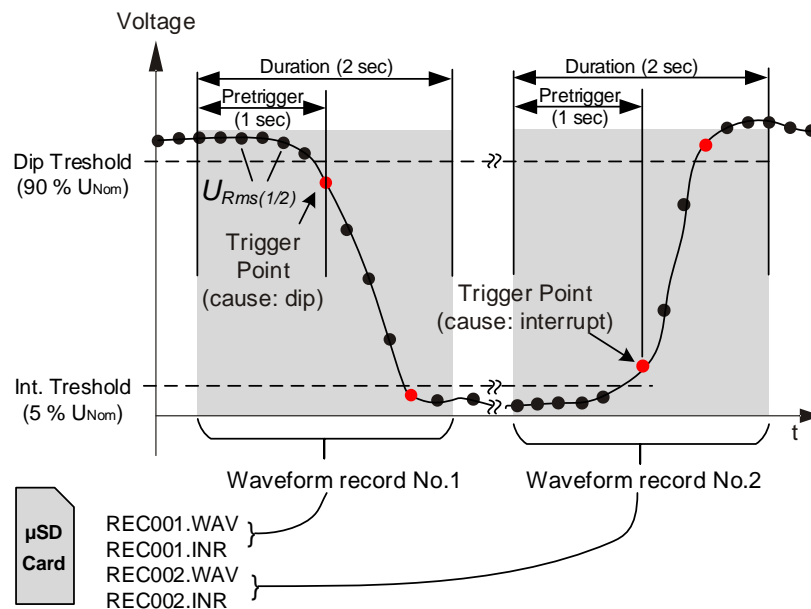

Figure 156: Voltage Event Triggering

- Voltage level – instrument starts waveform recorder when measured RMS voltage reaches given voltage threshold.

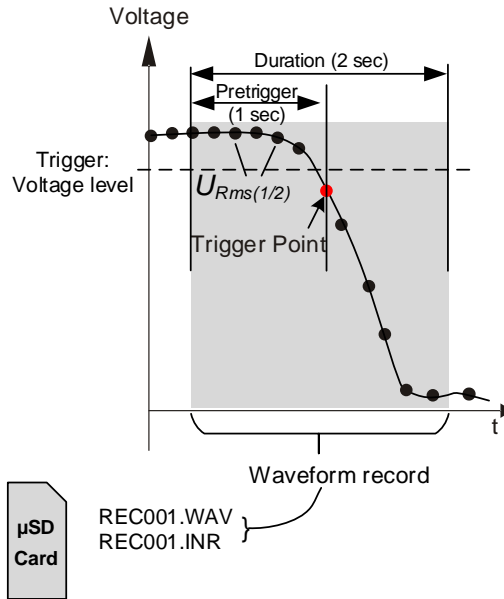

Figure 157: Voltage Level Triggering

- Current level - instrument starts waveform recorder when measured current reaches given current threshold. Typically, this type of triggering is used for capturing inrush currents.

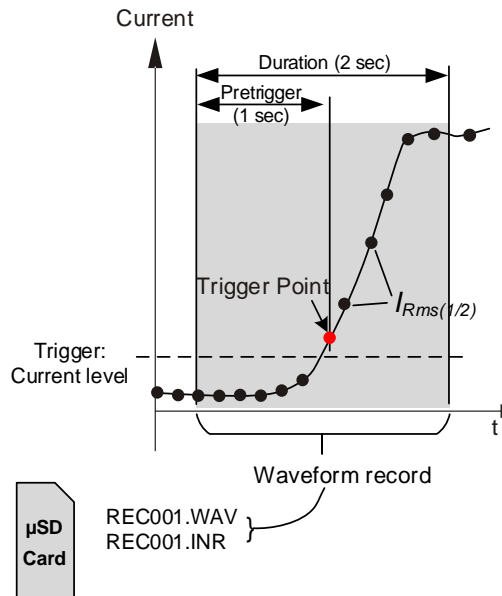

Figure 158: Current Level Triggering (Inrush)

- Alarms – instrument starts waveform recorder when any alarm from alarm list is detected. In order to see how to setup Alarm Table, please check section 3.21.3.
- Voltage events and alarms – instrument starts waveform recorder when either voltage event or alarm occur.
- Interval – instrument starts waveform recorder periodically, each time after given time interval Interval: 10min finish.
- User can perform single or continuous waveform recordings up to 200 records (default value; maximum number could be changed by the user – up to 1500). In continuous waveform

recording, Power Master XT will automatically initialize next waveform recording upon completion of the previous one.

Voltage event trigger

Waveform recorder can be set up to trigger on voltage events as shown on figure below.



Figure 159: Waveform recorder setup for triggering on voltage events

Inrush recorder

In addition to the waveform record which represent voltage samples, instrument also store RMS voltage $U_{Rms(1/2)}$ and current $I_{Rms(1/2)}$. This type of record is particularly suitable for capturing motor inrush. It gives analysis of voltage and current fluctuations during start of motor or other high-power consumers. For current $I_{Rms(1/2)}$ value (half cycle period RMS current refreshed each half cycle) is measured, while for voltage $U_{Rms(1/2)}$ values (one cycle RMS voltage refreshed each half cycle) is measured for each interval. In following figures, Level triggering is shown.

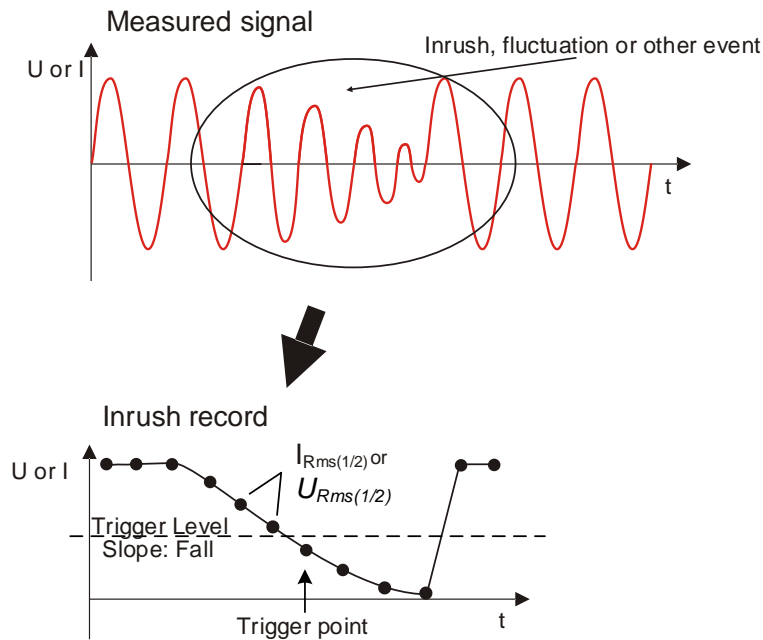

Figure 160: Level triggering

Triggering slope

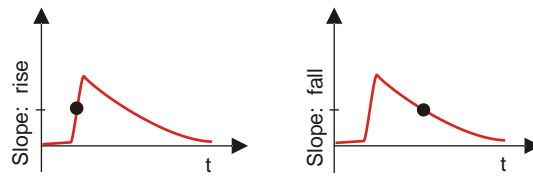

Figure 161: Triggering slope

5.1.20 Transient recorder

Transient recorder is similar to waveform recorder. It stores a selectable set of pre- and post-trigger samples on trigger activation, but with higher sampling rate (1MHz).

Recorder can be triggered on envelope or level.

Envelope trigger is activated if difference between same samples on two consecutive periods of triggering signal, is greater than given limit.

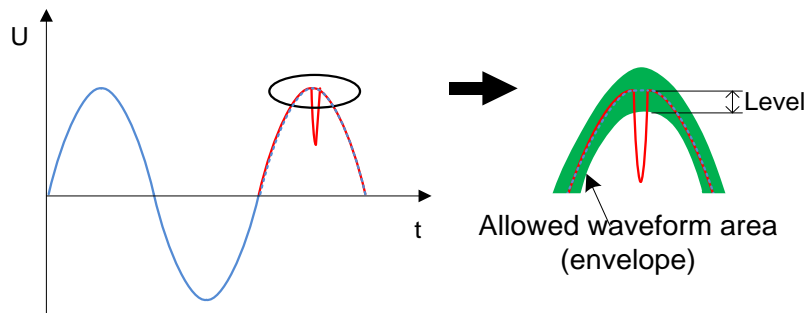

Figure 162: Transients trigger detection (envelope)

Level trigger is activated if sampled voltage/current is greater than given limit.

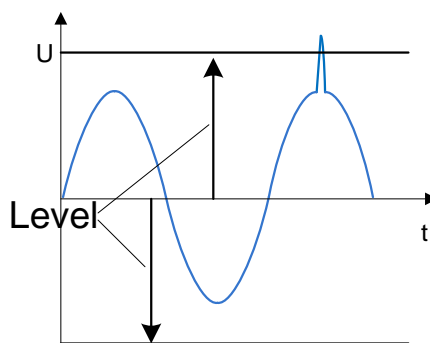

Figure 163: Transients trigger detection (level)

Note: Saving to the instrument data memory induces dead time between consecutive transient records up to 8 seconds, before new transient can be captured.

5.2 EN 50160 Standard Overview

EN 50160 standard defines, describes and specifies the main characteristics of the voltage at a network user's supply terminals in public low voltage and medium voltage distribution networks under normal operating conditions. This standard describe the limits or values within which the voltage characteristics can be expected to remain over the whole of the public distribution network and do not describe the average situation usually experienced by an individual network user. An overview of EN 50160 Low voltage limits are presented on table below.

Table 134: EN 50160 standard LV limits (continuous phenomena)

Supply voltage phenomenon	Acceptable limits	Meas. Interval	Monitoring Period	Acceptance Percentage
Power frequency	49.5 ÷ 50.5 Hz 47.0 ÷ 52.0 Hz	10 s	1 Week	99,5% 100%
Supply voltage variations, U_{Nom}	230V ± 10%	10 min	1 Week	95%
	230V +10% -15%			100%
Flicker severity Plt	Plt ≤ 1	2 h	1 Week	95%
Voltage unbalance u-	0 ÷ 2 %, occasionally 3%	10 min	1 Week	95%
Total harm. distortion, THD _U	8%	10 min	1 Week	95%
Harmonic Voltages, U_{h_n}	See Table 135: Values of individual harmonic voltages at the supply	10 min	1 Week	95%
Mains signalling	See Figure 164: Mains signalling voltage level limits according to EN50160	3 s	1 Day	99%

5.2.1 Power frequency

The nominal frequency of the supply voltage shall be 50 Hz, for systems with synchronous connection to an interconnected system. Under normal operating conditions the mean value of the fundamental frequency measured over 10 s shall be within a range of:

50 Hz ± 1 % (49,5 Hz .. 50,5 Hz) during 99,5 % of a year;
50 Hz + 4 % / - 6 % (i.e. 47 Hz .. 52 Hz) during 100 % of the time.

5.2.2 Supply voltage variations

Under normal operating conditions, during each period of one week 95 % of the 10 min mean U_{RMS} values of the supply voltage shall be within the range of $U_{Nom} \pm 10 \%$, and all U_{RMS} values of the supply voltage shall be within the range of $U_{Nom} + 10 \%$ / - 15 %.

5.2.3 Supply voltage unbalance

Under normal operating conditions, during each period of one week, 95 % of the 10 min mean RMS values of the negative phase sequence component (fundamental) of the supply voltage shall be within the range 0 % to 2 % of the positive phase sequence component (fundamental). In some areas with

partly single phase or two-phase connected network users' installations, unbalances up to about 3 % at three-phase supply terminals occur.

5.2.4 THD voltage and harmonics

Under normal operating conditions, during each period of one week, 95 % of the 10 min mean values of each individual harmonic voltage shall be less or equal to the value given in table below.

Moreover, THD_U values of the supply voltage (including all harmonics up to the order 40) shall be less than or equal to 8 %.

Table 135: Values of individual harmonic voltages at the supply

Not Multiples of 3		Odd harmonics		Even harmonics	
Order h	Relative voltage (U_N)	Multiples of 3	Relative voltage (U_N)	Order h	Relative voltage (U_N)
5	6,0 %	3	5,0 %	2	2,0 %
7	5,0 %	9	1,5 %	4	1,0 %
11	3,5 %	15	1,0 %	6..24	0,5 %
13	3,0 %	21	0,75 %		
17	2,0 %				
19	1,5 %				
23	1,5 %				
25	1,5 %				

5.2.5 Interharmonic voltage

The level of interharmonics is increasing due to the development of frequency converters and similar control equipment. Levels are under consideration, pending more experience. In certain cases interharmonics, even at low levels, give rise to flickers (see 5.2.7), or cause interference in ripple control systems.

5.2.6 Mains signalling on the supply voltage

In some countries the public distribution networks may be used by the public supplier for the transmission of signals. Over 99 % of a day the 3 s mean of signal voltages shall be less than or equal to the values given in the following figure.

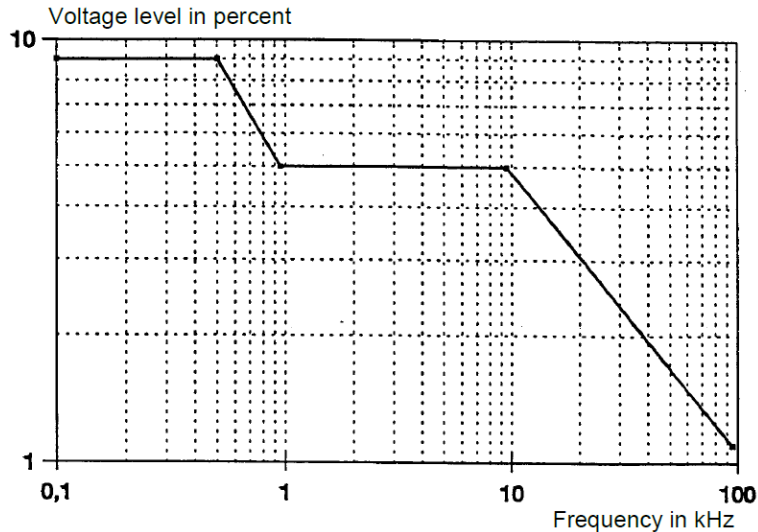

Figure 164: Mains signalling voltage level limits according to EN50160

5.2.7 Flicker severity

Under normal operating conditions, in any period of one week the long-term flicker severity caused by voltage fluctuation should be $P_{lt} \leq 1$ for 95 % of the time.

5.2.8 Voltage dips

Voltage dips are typically originated by faults occurring in the public network or in network users' installations. The annual frequency varies greatly depending on the type of supply system and on the point of observation. Moreover, the distribution over the year can be very irregular. The majority of voltage dips have duration less than 1 s and a retained voltage greater than 40 %. Conventionally, the dip start threshold is equal to 90 % of the nominal voltage of the nominal voltage. Collected voltage dips are classified according to the following table.

Table 136: Voltage dips classification

Residual voltage	Duration (ms)				
	$10 \leq t \leq 200$	$200 < t \leq 500$	$500 < t \leq 1000$	$1000 < t \leq 5000$	$5000 < t \leq 60000$
$90 > U \geq 80$	Cell A1	Cell A2	Cell A3	Cell A4	Cell A5
$80 > U \geq 70$	Cell B1	Cell B2	Cell B3	Cell B4	Cell B5
$70 > U \geq 40$	Cell C1	Cell C2	Cell C3	Cell C4	Cell C5
$40 > U \geq 5$	Cell D1	Cell D2	Cell D3	Cell D4	Cell D5
$U < 5$	Cell E1	Cell E2	Cell E3	Cell E4	Cell E5

5.2.9 Voltage swells

Voltage swells are typically caused by switching operations and load disconnections. Conventionally, the start threshold for swells is equal to the 110 % of the nominal voltage. Collected voltage swells are classified according to the following table.

Table 137: Voltage swell classification

Swell voltage	Duration (ms)		
	$10 \leq t \leq 500$	$500 < t \leq 5000$	$5000 < t \leq 60000$
$U \geq 120$	Cell A1	Cell A2	Cell A3
$120 > U > 110$	Cell B1	Cell B2	Cell B3

5.2.10 Short interruptions of the supply voltage

Under normal operating conditions the annual occurrence of short interruptions of the supply voltage ranges from up to a few tens to up to several hundreds. The duration of approximately 70 % of the short interruptions may be less than one second.

5.2.11 Long interruptions of the supply voltage

Under normal operating conditions the annual frequency of accidental voltage interruptions longer than three minutes may be less than 10 or up to 50 depending on the area.

5.2.12 Power Master XT recorder setting for EN 50160 survey

Power Master XT is able to perform EN 50160 surveys on all values described in previous sections. In order to simplify procedure, Power Master XT has predefined recorder configuration (EN 50160) for it. By default, all current parameters (RMS, THD, etc.) are also included in survey, which can provide additional survey information. Additionally, during voltage quality survey user can simultaneously record other parameters too, such as power, energy and current harmonics.

In order to collect voltage events during recording, **Include events** option in recorder should be enabled. See section 3.21.2 for voltage events settings.



Figure 165: Predefined EN50160 recorder configuration

After recording is finished, EN 50160 survey is performed on PowerView v3.0 software. See PowerView v3.0 manual for details.

6 Technical specifications

6.1 General specifications

Working temperature range:	-20 °C ÷ +55 °C
Storage temperature range:	-20 °C ÷ +70 °C
Max. humidity:	5 ÷ 98 % RH (0 °C ÷ 40 °C), non-condensing
Pollution degree:	2
Protection classification:	Reinforced insulation
Measuring category:	CAT IV / 600 V; For three phase connection CAT III / 1000 V; up to 3000 meters above sea level
Protection degree:	IP 40
Dimensions:	23 cm x 14cm x 8 cm
Weight (with batteries):	1.1 kg
Display:	Colour 4.3 TFT liquid crystal display (LCD) with backlight, 480 x 272 dots.
Memory:	8 GB microSD card provided, max. 32 GB supported
Batteries:	6 x 1.2 V NiMH rechargeable batteries type HR 6 (AA)
	Provide full operation for up to 5 hours*
External DC supply - charger:	100-240 V~, 50-60 Hz, 0.4 A~, CAT II 300 V 12 V DC, min 1.2 A
Maximum supply consumption:	12 V / 410 mA – without batteries 12 V / 1.2 A – while charging batteries
Battery charging time:	3 hours*
Communication:	USB 2.0 Standard USB Type B
	Ethernet 10Mb

* The charging time and the operating hours are given for batteries with a nominal capacity of 2500 mAh without display illumination and switching off the transient recorder during the powering via the batteries.

6.2 Measurements

6.2.1 General description

Max. input voltage (Phase – Neutral):	Three phase connection: 50 ... 1000 V _{RMS} Phase connection: 50 ... 500 V _{RMS}
Max. input voltage (Phase – Phase):	87 ... 1730 V _{RMS}
Max. transient peak voltage	±6 kV
Max. transient peak current	Depends on used current clamps (check specification for current clamps) For transient detection use fixed current range.
Phase - Neutral input impedance:	2.45 MΩ
Phase – Phase input impedance:	2.45 MΩ
AD converter	16 bit 8 channels, simultaneous sampling
Sampling frequency:	
50Hz / 60 Hz System frequency	7 kSamples/sec

Antialiasing filter	Passband (-3dB): 0 ÷ 3.4 kHz Stopband (-80dB): > 3,8 kHz
400 Hz System frequency Antialiasing filter	12,2 kSamples/sec Passband (-3dB): 0 ÷ 5,7kHz Stopband (-80dB): > 6,44 kHz
VFD -Variable Frequency Drive mode Antialiasing filter	1,7 kSamples/sec Passband (-3dB): 0 ÷ 782 Hz Stopband (-80dB): > 883 Hz
Transient mode Antialiasing filter	1 MSamples/sec Passband (-3dB): 0 ÷ 600 kHz
Reference temperature	23 °C ± 2 °C
Temperature influence	25 ppm/°C

NOTE: Instrument has 3 internal voltage ranges. Range is chosen automatically, according to the chosen Nominal Voltage parameter. See tables below for details.

Nominal phase (L-N) voltage: U_{Nom}	Voltage range
50 V ÷ 136 V (L-N)	Range 1
137 V ÷ 374 V (L-N)	Range 2
375 V ÷ 1000 V (L-N)	Range 3

Nominal phase-to-phase (L-L) voltage: U_{Nom}	Voltage range
50 V ÷ 235 V (L-L)	Range 1
236 V ÷ 649 V (L-L)	Range 2
650V ÷ 1730 V (L-L)	Range 3

NOTE: Assure that all voltage clips are connected during measurement and logging period. Unconnected voltage clips are susceptible to EMI and can trigger false events. It is advisable to short them with instrument neutral voltage input.

6.2.2 Phase Voltages

10/12 cycle phase RMS voltage: U_{1Rms} , U_{2Rms} , U_{3Rms} , U_{NRms} , AC+DC

Measuring Range	Resolution*	Accuracy	Nominal Voltage U_{NOM}
10% U_{NOM} ÷ 150% U_{NOM}	10 mV, 100mV	± 0.1 % · U_{NOM}	50 ÷ 1000 V (L-N)

* - depends on measured voltage

Half cycle RMS voltage (events, min, max): $U_{1Rms(1/2)}$, $U_{2Rms(1/2)}$, $U_{3Rms(1/2)}$, U_{1Min} , U_{2Min} , U_{3Min} , U_{1Max} , U_{2Max} , U_{3Max} , AC+DC

Measuring Range	Resolution*	Accuracy	Nominal Voltage U_{NOM}
3% U_{NOM} ÷ 150% U_{NOM}	10 mV, 100mV	± 0.2 % · U_{NOM}	50 ÷ 1000 V (L-N)

* - depends on measured voltage

NOTE: Voltage events measurements are based on half cycle RMS voltage.

Crest factor: CF_{U1} , CF_{U2} , CF_{U3} , CF_{UN}

Measuring range	Resolution*	Accuracy
1.00 ÷ 2.50	0.01	± 5 % · CF_U

* - depends on measured voltage

Peak voltage: U_{1Pk} , U_{2Pk} , U_{3Pk} , AC+DC

Measuring range	Resolution*	Accuracy
Range 1: 20.00 ÷ 255.0 Vpk	10 mV, 100 mV	$\pm 0.5 \% \cdot U_{Pk}$
Range 2: 50.0 V ÷ 510.0 Vpk	10 mV, 100 mV	$\pm 0.5 \% \cdot U_{Pk}$
Range 3: 200.0 V ÷ 2250.0 Vpk	100 mV, 1V	$\pm 0.5 \% \cdot U_{Pk}$

* - depends on measured voltage

6.2.3 Line voltages

10/12 cycle line to line RMS voltage: U_{12Rms} , U_{23Rms} , U_{31Rms} , AC+DC

Measuring Range	Resolution*	Accuracy	Nominal Voltage range
10% U_{NOM} ÷ 150% U_{NOM}	10 mV, 100mV	$\pm 0.1 \% \cdot U_{NOM}$	50 ÷ 1730 V (L-L)

Half cycle RMS voltage (events, min, max): $U_{12Rms(1/2)}$, $U_{23Rms(1/2)}$, $U_{31Rms(1/2)}$, U_{12Min} , U_{23Min} , U_{31Min} , U_{12Max} , U_{23Max} , U_{31Max} , AC+DC

Measuring Range	Resolution*	Accuracy	Nominal Voltage range
10% U_{NOM} ÷ 150% U_{NOM}	10 mV, 100mV	$\pm 0.2 \% \cdot U_{NOM}$	50 ÷ 1730 V (L-L)

Crest factor: CF_{U21} , CF_{U23} , CF_{U31}

Measuring range	Resolution	Accuracy
1.00 ÷ 2.50	0.01	$\pm 5 \% \cdot CF_U$

Peak voltage: U_{12Pk} , U_{23Pk} , U_{31Pk} , AC+DC

Measuring range	Resolution	Accuracy
Range 1: 20.00 ÷ 422 Vpk	10 mV, 100 mV	$\pm 0.5 \% \cdot U_{Pk}$
Range 2: 47.0 V ÷ 884.0 Vpk	10 mV, 100 mV	$\pm 0.5 \% \cdot U_{Pk}$
Range 3: 346.0 V ÷ 3700 Vpk	100 mV, 1 V	$\pm 0.5 \% \cdot U_{Pk}$

6.2.4 Current

Input impedance: 65 k Ω

10/12 cycle RMS current I_{1Rms} , I_{2Rms} , I_{3Rms} , I_{NRms} , AC+DC.

Clamps	Range	Measuring range	Overall current accuracy
A 1281	1000 A	100 A ÷ 1200 A	$\pm 0.5 \% \cdot I_{RMS}$
	100 A	10 A ÷ 175 A	
	5 A	0.5 A ÷ 10 A	
	0.5 A	50 mA ÷ 1 A	
A 1588	50 A	5 A ÷ 100 A	$\pm 0.5 \% \cdot I_{RMS}$
	5 A	0.5 A ÷ 10 A	
	0.5 A	50 mA ÷ 1 A	
A 1033	1000 A	20 A ÷ 1000 A	$\pm 1.3 \% \cdot I_{RMS}$
	100 A	2 A ÷ 100 A	
A 1069	100 A	5 A ÷ 200 A	$\pm 1.3 \% \cdot I_{RMS}$

	10 A	500 mA ÷ 20 A	
A 1391 PQA	100 A 10 A	5 A ÷ 200 A 500 mA ÷ 20 A	$\pm 1.3 \% \cdot I_{RMS}$
A 1636	DC: 2000 A AC: 1000 A	40 A ÷ 2000 A 20 A ÷ 1000 A	$\pm 1.3 \% \cdot I_{RMS}$
A 1227	3000 A 300 A 30 A	300 A ÷ 6000 A 30 A ÷ 600 A 3 A ÷ 60 A	$\pm 1.5 \% \cdot I_{RMS}$
A 1227 5M	3000 A 300 A 30 A	300 A ÷ 6000 A 30 A ÷ 600 A 3 A ÷ 60 A	$\pm 1.5 \% \cdot I_{RMS}$
A 1445	3000 A 300 A 30 A	300 A ÷ 6000 A 30 A ÷ 600 A 3 A ÷ 60 A	$\pm 1.5 \% \cdot I_{RMS}$
A 1582	3000 A 300 A 30 A	300 A ÷ 6000 A 30 A ÷ 600 A 3 A ÷ 60 A	$\pm 1.5 \% \cdot I_{RMS}$
A 1501	3000 A 300 A 30 A	300 A ÷ 6000 A 30 A ÷ 600 A 3 A ÷ 60 A	$\pm 1.5 \% \cdot I_{RMS}$
A 1502	3000 A 300 A 30 A	300 A ÷ 6000 A 30 A ÷ 600 A 3 A ÷ 60 A	$\pm 1.5 \% \cdot I_{RMS}$
A 1503	6000 A 600 A 60 A	600 A ÷ 12 000 A 60 A ÷ 1200 A 6 A ÷ 120 A	$\pm 1.5 \% \cdot I_{RMS}$
A 1446	6000 A 600 A 60 A	600 A ÷ 12 000 A 60 A ÷ 1200 A 6 A ÷ 120 A	$\pm 1.5 \% \cdot I_{RMS}$
A 1037	6 A 0.5 A	0.5 A ÷ 10 A 10 mA ÷ 10 A	$\pm 0.3 \% \cdot I_{RMS}$

Note: Overall current accuracy (as percent of measured value), is provided as guideline. For exact measuring range and accuracy please check user manual of related current clamps. Overall accuracy is calculated as:

$$\text{Overall Accuracy} = 1,15 \cdot \sqrt{\text{Instrument Accuracy}^2 + \text{Clamp Accuracy}^2}$$

Half cycle RMS current (inrush, min, max) $I_{1Rms(1/2)}$, $I_{2Rms(1/2)}$, $I_{3Rms(1/2)}$, $I_{NRms(1/2)}$, AC+DC

Clamps	Range	Measuring range	Overall current accuracy
A 1281	1000 A 100 A 5 A 0.5 A	100 A ÷ 1200 A 10 A ÷ 175 A 0.5 A ÷ 10 A 50 mA ÷ 1 A	$\pm 0.8 \% \cdot I_{RMS}$
A 1588	50 A 5 A 0.5 A	5 A ÷ 100 A 0.5 A ÷ 10 A 50 mA ÷ 1 A	$\pm 0.8 \% \cdot I_{RMS}$
A 1033	1000 A 100 A	20 A ÷ 1000 A 2 A ÷ 100 A	$\pm 1.3 \% \cdot I_{RMS}$
A 1069	100 A 10 A	5 A ÷ 200 A 500 mA ÷ 20 A	$\pm 1.3 \% \cdot I_{RMS}$
A 1391 PQA	100 A 10 A	5 A ÷ 200 A 500 mA ÷ 20 A	$\pm 1.5 \% \cdot I_{RMS}$

A 1636	DC: 2000 A AC: 1000 A	40 A ÷ 2000 A 20 A ÷ 1000 A	$\pm 1.5 \% \cdot I_{RMS}$
A 1227	3000 A 300 A 30 A	300 A ÷ 6000 A 30 A ÷ 600 A 3 A ÷ 60 A	$\pm 1.6 \% \cdot I_{RMS}$
A 1227 5M	3000 A 300 A 30 A	300 A ÷ 6000 A 30 A ÷ 600 A 3 A ÷ 60 A	$\pm 1.6 \% \cdot I_{RMS}$
A 1445	3000 A 300 A 30 A	300 A ÷ 6000 A 30 A ÷ 600 A 3 A ÷ 60 A	$\pm 1.6 \% \cdot I_{RMS}$
A 1582	3000 A 300 A 30 A	300 A ÷ 6000 A 30 A ÷ 600 A 3 A ÷ 60 A	$\pm 1.6 \% \cdot I_{RMS}$
A 1501	3000 A 300 A 30 A	300 A ÷ 6000 A 30 A ÷ 600 A 3 A ÷ 60 A	$\pm 1.6 \% \cdot I_{RMS}$
A 1502	3000 A 300 A 30 A	300 A ÷ 6000 A 30 A ÷ 600 A 3 A ÷ 60 A	$\pm 1.6 \% \cdot I_{RMS}$
A 1503	6000 A 600 A 60 A	600 A ÷ 12 000 A 60 A ÷ 1200 A 6 A ÷ 120 A	$\pm 1.6 \% \cdot I_{RMS}$
A 1446	6000 A 600 A 60 A	600 A ÷ 12 000 A 60 A ÷ 1200 A 6 A ÷ 120 A	$\pm 1.6 \% \cdot I_{RMS}$
A 1037	6 A 0.5 A	0.5 A ÷ 10 A 10 mA ÷ 10 A	$\pm 0.4 \% \cdot I_{RMS}$

Note: Overall current accuracy (as percent of measured value), is provided as guideline. For exact measuring range and accuracy please check user manual of related current clamps. Overall accuracy is calculated as:

$$OverallAccuracy = 1,15 \cdot \sqrt{InstrumentAccuracy^2 + ClampAccuracy^2}$$

Peak value I_{1Pk} , I_{2Pk} , I_{3Pk} , I_{NPK} , AC+DC

Measurement accessory	Peak value	Overall current accuracy	
A 1281	1000 A 100 A 5 A 0.5 A	100 A ÷ 1700 A 10 A ÷ 250 A 0.5 A ÷ 14 A 50 mA ÷ 1.4 A	$\pm 0.8 \% \cdot I_{RMS}$
A 1588	50 A 5 A 0.5 A	5 A ÷ 150 A 0.5 A ÷ 15 A 50 mA ÷ 1.5 A	$\pm 0.8 \% \cdot IRMS$
A 1033	1000 A 100 A	20 A ÷ 1400 A 2 A ÷ 140 A	$\pm 1.3 \% \cdot I_{RMS}$
A 1069	100 A 10 A	5 A ÷ 280 A 500 mA ÷ 28 A	$\pm 1.3 \% \cdot I_{RMS}$
A 1391 PQA	100 A 10 A	5 A ÷ 280 A 500 mA ÷ 28 A	$\pm 1.5 \% \cdot I_{RMS}$
A 1636	DC: 2000 A AC: 1000 A	40 A ÷ 2800 A 20 A ÷ 1400 A	$\pm 1.5 \% \cdot I_{RMS}$
A 1227	3000 A	300 A ÷ 8500 A	$\pm 1.6 \% \cdot I_{RMS}$

	300 A 30 A	30 A ÷ 850 A 3 A ÷ 85 A	
A 1227 5M	3000 A 300 A 30 A	300 A ÷ 8500 A 30 A ÷ 850 A 3 A ÷ 85 A	$\pm 1.6 \% \cdot I_{RMS}$
A 1445	3000 A 300 A 30 A	300 A ÷ 8500 A 30 A ÷ 850 A 3 A ÷ 85 A	$\pm 1.6 \% \cdot I_{RMS}$
A 1582	3000 A 300 A 30 A	300 A ÷ 8500 A 30 A ÷ 850 A 3 A ÷ 85 A	$\pm 1.6 \% \cdot I_{RMS}$
A 1501	3000 A 300 A 30 A	300 A ÷ 8500 A 30 A ÷ 850 A 3 A ÷ 85 A	$\pm 1.6 \% \cdot I_{RMS}$
A 1502	3000 A 300 A 30 A	300 A ÷ 8500 A 30 A ÷ 850 A 3 A ÷ 85 A	$\pm 1.6 \% \cdot I_{RMS}$
A 1503	6000 A 600 A 60 A	600 A ÷ 17 000 A 60 A ÷ 1700 A 6 A ÷ 170 A	$\pm 1.6 \% \cdot I_{RMS}$
A 1446	6000 A 600 A 60 A	600 A ÷ 17 000 A 60 A ÷ 1700 A 6 A ÷ 170 A	$\pm 1.6 \% \cdot I_{RMS}$
A 1037	5 A 0.5 A	0.5 A ÷ 14 A 10 mA ÷ 1.4 A	$\pm 0.4 \% \cdot I_{RMS}$

Note: Overall current accuracy (as percent of measured value), is provided as guideline. For exact measuring range and accuracy please check user manual of related current clamps. Overall accuracy is calculated as:

$$\text{Overall Accuracy} = 1,15 \cdot \sqrt{\text{Instrument Accuracy}^2 + \text{Clamp Accuracy}^2}$$

Crest factor CF_{ip} p : [1, 2, 3, 4, N], AC+DC

Measuring range	Resolution	Accuracy
1.00 ÷ 10.00	0.01	$\pm 5 \% \cdot CF_1$

Accuracy of 10/12 cycle RMS voltage measured on current input

Measuring range (Intrinsic instrument accuracy)	Accuracy
Range 1: 10.0 mV _{RMS} ÷ 300.0 mV _{RMS}	$\pm 0.25 \% \cdot U_{RMS}$
Range 2: 50.0 mV _{RMS} ÷ 3.000 V _{RMS}	

Measuring range	Accuracy	Crest factor
Range 1: 10.0 mV _{RMS} ÷ 150.0 mV _{RMS}	$\pm 0.25 \% \cdot U_{RMS}$	3.0
Range 2: 50.0 mV _{RMS} ÷ 1.500 V _{RMS}		

U_{RMS} – RMS voltage measured on current input

Accuracy of half cycle RMS voltage measured on current input

Measuring range (Intrinsic instrument accuracy)	Accuracy
Range 1: 10.0 mV _{RMS} ÷ 300.0 mV _{RMS}	$\pm 0.5 \% \cdot U_{RMS}$
Range 2: 50.0 mV _{RMS} ÷ 3.000 V _{RMS}	$\pm 0.5 \% \cdot U_{RMS}$

Measuring range (Intrinsic instrument accuracy)	Accuracy	Crest factor
Range 1: 10.0 mV _{RMS} ÷ 150.0 mV _{RMS}	± 0.5 % · U _{RMS}	3.0
Range 2: 50.0 mV _{RMS} ÷ 1.500 V _{RMS}	± 0.5 % · U _{RMS}	

6.2.5 Frequency

Measuring range	Resolution	Accuracy
50 Hz system frequency: 42.500 Hz ÷ 57.500 Hz 60 Hz system frequency: 51.000 Hz ÷ 69.000 Hz	1 mHz	± 10 mHz
400 Hz system frequency: 335.0 Hz ÷ 465.0 Hz	10 mHz	± 100 mHz

6.2.6 Flickers

Flicker type	Measuring range	Resolution	Accuracy*
P _{inst}	0.200 ÷ 10.000	0.001	± 5 % · P _{inst}
P _{st}	0.200 ÷ 10.000		± 5 % · P _{st}
P _{lt}	0.200 ÷ 10.000		± 5 % · P _{lt}

6.2.7 Transients

Type	Measuring range	Resolution	Accuracy
Voltage Transients	± 6 kV	5V	± 5 %
Current Transients	Depends on the selected current clamp		± 10 %

Note: Overall current transient accuracy (as percent of measured value), is provided as guideline. For exact measuring range and accuracy please check user manual of related current clamps.

Combined power

Combined Power	Measuring range		Accuracy
Active power* (W) P ₁ , P ₂ , P ₃ , P _{tot}	0.000 k ÷ 999.9 M 4 digits	Excluding clamps (Instrument only)	±0.2 % · P
		With flex clamps A 1227/A 1445/A 1501/A 1502 / 3000A A 1446/A 1503 / 6000A	±1.7 % · P
		With iron clamps A 1281 / 1000 A A 1588 / 150 A	±0.7 % · P
		Excluding clamps (Instrument only)	±0.2 % · Q
Nonactive power** (var) N ₁ , N ₂ , N ₃ , N _{tot} , Na _{tot}	0.000 k ÷ 999.9 M 4 digits	With flex clamps A 1227/A 1445/A 1501/A 1502 / 3000A A 1446/A 1503 / 6000A	±1.7 % · Q
		With iron clamps A 1281 / 1000 A A 1588 / 150 A	±0.7 % · Q
		Excluding clamps (Instrument only)	±0.2 % · Q
		With flex clamps A 1227/A 1445/A 1501/A 1502 / 3000A A 1446/A 1503 / 6000A	±1.7 % · Q

Apparent power*** (VA) $S_1, S_2, S_3, S_{e_{tot}}, S_{v_{tot}}, S_{a_{tot}}$	0.000 k ÷ 999.9 M 4 digits	Excluding clamps (Instrument only)	$\pm 0.5 \% \cdot Q$
		With flex clamps A 1227/A 1445/A 1501/A 1502 / 3000A	$\pm 1.8 \% \cdot S$
		A 1446/A 1503 / 6000A	
		With iron clamps A 1281 / 1000 A A 1588 / 150 A	$\pm 0.8 \% \cdot S$

*Accuracy values are valid if $\cos \varphi \geq 0.80$, $I \geq 10 \% I_{Nom}$ and $U \geq 80 \% U_{Nom}$

**Accuracy values are valid if $\sin \varphi \geq 0.50$, $I \geq 10 \% I_{Nom}$ and $U \geq 80 \% U_{Nom}$

***Accuracy values are valid if $\cos \varphi \geq 0.50$, $I \geq 10 \% I_{Nom}$ and $U \geq 80 \% U_{Nom}$

6.2.8 Fundamental power

Fundamental power	Measuring range		Accuracy
Active fundamental power* (W) $P_{fund_1}, P_{fund_2}, P_{fund_3}, P_{tot}^+$	0.000 k ÷ 999.9 M 4 digits	Excluding clamps (Instrument only)	$\pm 0.2 \% \cdot P_{fund}$
		With flex clamps A 1227/A 1445/A 1501/A 1502 / 3000A	$\pm 1.7 \% \cdot P_{fund}$
		A 1446/A 1503 / 6000A	
		With iron clamps A 1281 / 1000 A A 1588 / 150 A	$\pm 0.7 \% \cdot P_{fund}$
Reactive fundamental power** (var) $Q_{fund_1}, Q_{fund_2}, Q_{fund_3},$ Q_{tot}^+	0.000 k ÷ 999.9 M 4 digits	Excluding clamps (Instrument only)	$\pm 0.2 \% \cdot Q_{fund}$
		With flex clamps A 1227/A 1445/A 1501/A 1502 / 3000A	$\pm 1.7 \% \cdot Q_{fund}$
		A 1446/A 1503 / 6000A	
		With iron clamps A 1281 / 1000 A A 1588 / 150 A	$\pm 0.7 \% \cdot Q_{fund}$
Apparent fundamental power*** (VA)	0.000 k ÷ 999.9 M	Excluding clamps (Instrument only)	$\pm 0.2 \% \cdot S_{fund}$

Sfund ₁ , Sfund ₂ , Sfund ₃ , S ⁺ _{tot}	4 digits	With flex clamps A 1227/A 1445/A 1501/A 1502 / 3000A A 1446/A 1503 / 6000A	±1.7 % · Sfund
		With iron clamps A 1281 / 1000 A A 1588 / 150 A	±0.7 % · Sfund

*Accuracy values are valid if $\cos \varphi \geq 0.80$, $I \geq 10 \% I_{Nom}$ and $U \geq 80 \% U_{Nom}$

**Accuracy values are valid if $\sin \varphi \geq 0.50$, $I \geq 10 \% I_{Nom}$ and $U \geq 80 \% U_{Nom}$

***Accuracy values are valid if $\cos \varphi \geq 0.50$, $I \geq 10 \% I_{Nom}$ and $U \geq 80 \% U_{Nom}$

6.2.9 Nonfundamental power

Nonfundamental power	Measuring range	Conditions	Accuracy
Active harmonic power* (W) Ph ₁ , Ph ₂ , Ph ₃ , Ph _{tot}	0.000 k ÷ 999.9 M 4 digits	Excluding clamps (Instrument only) Ph > 1% · P	±1.0% · Ph
Current distortion power* (var) D _{I1} , D _{I2} , D _{I3} , De _I	0.000 k ÷ 999.9 M 4 digits	Excluding clamps (Instrument only) D _I > 1% · S	±2.0% · D _I
Voltage distortion power* (var) D _{V1} , D _{V2} , D _{V3} , De _V	0.000 k ÷ 999.9 M 4 digits	Excluding clamps (Instrument only) D _V > 1% · S	±2.0% · D _V
Harmonics distortion power* (var) D _{H1} , D _{H2} , D _{H3} , De _H	0.000 k ÷ 999.9 M 4 digits	Excluding clamps (Instrument only) D _H > 1% · S	±2.0% · D _H
Apparent nonfundamental power* (VA) S _{N1} , S _{N2} , S _{N3} , Se _N	0.000 k ÷ 999.9 M 4 digits	Excluding clamps (Instrument only) S _N > 1% · S	±1.0% · S _N

Apparent harmonic power* (VA) $S_{H1}, S_{H2}, S_{H3}, S_{eH}$	0.000 k ÷ 999.9 M 4 digits	Excluding clamps (Instrument only) $S_H > 1\% \cdot S$	$\pm 2.0\% \cdot S_H$
---	-----------------------------------	---	-----------------------

*Accuracy values are valid if $I \geq 10\% I_{Nom}$ and $U \geq 80\% U_{Nom}$

6.2.10 Power factor (PF, PFe, PFv, PFa)

Measuring range	Resolution	Accuracy
-1.00 ÷ 1.00	0.01	± 0.02

6.2.11 Displacement factor (DPF) or Cos ϕ

Measuring range	Resolution	Accuracy
-1.00 ÷ 1.00	0.01	± 0.02

6.2.12 Energy

		Measuring range (kWh, kvarh, kVAh)	Resolution	Accuracy
Active energy Ep*	Excluding clamps (Instrument only)	000,000,000.001 ÷ 999,999,999.999	12 digits	$\pm 0.5\% \cdot E_p$
	With A 1227/A 1445/A 1446/A 1501/A 1502/A 1503 Flex clamps	000,000,000.001 ÷ 999,999,999.999		$\pm 1.8\% \cdot E_p$
	With A 1281/A 1588 Multirange iron clamps	000,000,000.001 ÷ 999,999,999.999		$\pm 0.8\% \cdot E_p$
	With A 1033 1000 A	000,000,000.001 ÷ 999,999,999.999		$\pm 1.6\% \cdot E_p$
Reactive energy Eq**	Excluding clamps (Instrument only)	000,000,000.001 ÷ 999,999,999.999	12 digits	$\pm 0.5\% \cdot E_q$
	With A 1227/A 1445/A 1446/A 1501/A 1502/A 1503 Flex clamps	000,000,000.001 ÷ 999,999,999.999		$\pm 1.8\% \cdot E_q$
	With A 1281/A 1588 Multirange clamps	000,000,000.001 ÷ 999,999,999.999		$\pm 0.8\% \cdot E_q$
	With A 1033 1000 A	000,000,000.001 ÷ 999,999,999.999		$\pm 1.6\% \cdot E_q$

*Accuracy values are valid if $\cos \phi \geq 0.80$, $I \geq 10\% I_{Nom}$ and $U \geq 80\% U_{Nom}$

**Accuracy values are valid if $\sin \phi \geq 0.50$, $I \geq 10\% I_{Nom}$ and $U \geq 80\% U_{Nom}$

6.2.13 Voltage harmonics and THD

Measuring range	Harmonic	System	Resolution	Accuracy
-----------------	----------	--------	------------	----------

	component N	frequency		
$U_{hN} < 1 \% U_{Nom}$	0 ÷ 50 th	50/60Hz	10 mV	$\pm 0.15 \% \cdot U_{Nom}$
$1 \% U_{Nom} < U_{hN} < 20 \% U_{Nom}$			10 mV	$\pm 5 \% \cdot U_{hN}$
$U_{hN} < 1 \% U_{Nom}$	0 ÷ 13 th	400Hz	10 mV	$\pm 0.15 \% \cdot U_{Nom}$
$1 \% U_{Nom} < U_{hN} < 20 \% U_{Nom}$			10 mV	$\pm 5 \% \cdot U_{hN}$
$U_{hN} < 1 \% U_{Nom}$	0 ÷ 20 ^{th (1)}	VFD*	10 mV	$\pm 0.15 \% \cdot U_{Nom}$
$1 \% U_{Nom} < U_{hN} < 20 \% U_{Nom}$	0 ÷ 13 ^{th (2)}		10 mV	$\pm 0.15 \% \cdot U_{Nom}$
	0 ÷ 5 ^{th (3)}		10 mV	$\pm 5 \% \cdot U_{hN}$

U_{Nom} : Nominal voltage (RMS)

U_{hN} : measured harmonic voltage

N : harmonic component

(1): If fundamental voltage frequency is within 5÷16Hz range

(2): If fundamental voltage frequency is within 16÷33Hz range

(3): If fundamental voltage frequency is within 33 ÷ 110Hz

Measuring range	Resolution	Accuracy
$0 \% U_{Nom} < THD_U < 20 \% U_{Nom}$	0.1 %	± 0.3

U_{Nom} : nominal voltage (RMS)

6.2.14 Current harmonics, THD and k-factor

Measuring range	Harmonic component N	System frequency	Resolution	Accuracy
$I_{hN} < 10 \% I_{Nom}$	0 ÷ 50 th	50/60Hz	10 mV	$\pm 0.15 \% \cdot I_{Nom}$
$10 \% I_{Nom} < I_{hN} < 100 \%$			10 mV	$\pm 5 \% \cdot I_{hN}$
$I_{hN} < 10 \% I_{Nom}$	0 ÷ 13 th	400Hz	10 mV	$\pm 0.15 \% \cdot I_{Nom}$
$10 \% I_{Nom} < I_{hN} < 100 \%$			10 mV	$\pm 5 \% \cdot I_{hN}$
$I_{hN} < 10 \% I_{Nom}$	0 ÷ 20 ^{th (1)}	VFD*	10 mV	$\pm 0.15 \% \cdot I_{Nom}$
$10 \% I_{Nom} < I_{hN} < 100 \%$	0 ÷ 13 ^{th (2)}		10 mV	$\pm 0.15 \% \cdot I_{Nom}$
	0 ÷ 5 ^{th (3)}		10 mV	$\pm 5 \% \cdot I_{hN}$

I_{Nom} : Nominal voltage (RMS)

I_{hN} : measured harmonic current

N : harmonic component

(1): If fundamental voltage frequency is within 5÷16Hz range

(2): If fundamental voltage frequency is within 16÷33Hz range

(3): If fundamental voltage frequency is within 33 ÷ 110Hz

Measuring range	Resolution	Accuracy
$0 \% I_{Nom} < THD_I < 100 \% I_{Nom}$	0.1 %	± 0.6
$100 \% I_{Nom} < THD_I < 200 \% I_{Nom}$	0.1 %	± 0.3

I_{Nom} : Nominal current (RMS)

Measuring range	Resolution	Accuracy
$0 < k < 200$	0.1	± 0.6

6.2.15 Voltage interharmonics

Measuring range	Harmonic component N	System frequency	Resolution	Accuracy
$U_{ihN} < 1 \% U_{Nom}$	0 ÷ 50 th	50/60Hz	10 mV	$\pm 0.15 \% \cdot U_{Nom}$

$1 \% U_{Nom} < U_{ihN} < 20 \% U_{Nom}$			10 mV	$\pm 5 \% \cdot U_{hN}$
$U_{ihN} < 1 \% U_{Nom}$	$0 \div 20^{th(1)}$	VFD*	10 mV	$\pm 0.15 \% \cdot U_{Nom}$
$1 \% U_{Nom} < U_{ihN} < 20 \% U_{Nom}$	$0 \div 13^{th(2)}$		10 mV	$\pm 5 \% \cdot U_{hN}$
	$0 \div 5^{th(3)}$			

U_{Nom} : Nominal voltage (RMS)

U_{ihN} : measured harmonic voltage

N : interharmonic component

(1): If fundamental voltage frequency is within 5÷16Hz range

(2): If fundamental voltage frequency is within 16÷33Hz range

(3): If fundamental voltage frequency is within 33 ÷ 110Hz

6.2.16 Current interharmonics

Measuring range	Harmonic component N	System frequency	Resolution	Accuracy
$I_{ihN} < 10 \% I_{Nom}$	$0 \div 50^{th}$	50/60Hz	10 mV	$\pm 0.15 \% \cdot I_{Nom}$
$10 \% I_{Nom} < I_{ihN} < 100 \%$			10 mV	$\pm 5 \% \cdot I_{ihN}$
$I_{ihN} < 10 \% I_{Nom}$	$0 \div 20^{th(1)}$ $0 \div 13^{th(2)}$ $0 \div 5^{th(3)}$	VFD*	10 mV	$\pm 0.15 \% \cdot I_{Nom}$
$10 \% I_{Nom} < I_{ihN} < 100 \%$			10 mV	$\pm 5 \% \cdot I_{ihN}$

I_{Nom} : Nominal current (RMS)

I_{ihN} : measured interharmonic current

N : interharmonic component $0^{th} \div 50^{th}$

(1): If fundamental voltage frequency is within 5÷16Hz range

(2): If fundamental voltage frequency is within 16÷33Hz range

(3): If fundamental voltage frequency is within 33 ÷ 110Hz

6.2.17 Signalling

Measuring range	Resolution	Accuracy
$1 \% U_{Nom} < U_{Sig} < 3 \% U_{Nom}$	10 mV	$\pm 0.15 \% \cdot U_{Nom}$
$3 \% U_{Nom} < U_{Sig} < 20 \% U_{Nom}$	10 mV	$\pm 5 \% \cdot U_{Sig}$

U_{Nom} : Nominal current (RMS)

U_{Sig} : Measured signalling voltage

6.2.18 Unbalance

	Unbalance range	Resolution	Accuracy
u^-	0.5 % ÷ 5.0 %	0.1 %	$\pm 0.15 \%$
u^0			$\pm 0.15 \%$
i^-	0.0 % ÷ 20 %	0.1 %	$\pm 1 \%$
i^0			$\pm 1 \%$

6.2.19 Overdeviation and Underdeviation

	Measuring range	Resolution	Accuracy
U_{Over}	$0 \div 50 \% U_{Nom}$	0.001 %	$\pm 0.15 \%$
U_{Under}	$0 \div 90 \% U_{Nom}$	0.001 %	$\pm 0.15 \%$

6.2.20 Time and duration uncertainty

Standard compliance: IEC 61000-4-30 Class A (Section 4.6)

Real time clock (RTC) temperature uncertainty

Operating range	Accuracy	
-20 °C ÷ 70 °C	± 3.5 ppm	0.3 s/day
0 °C ÷ 40 °C	± 2.0 ppm	0.17 s/day

Real time clock (GPS) temperature uncertainty

Operating range	Accuracy
-20 °C ÷ 70 °C	± 2 ms / indefinitely long

Event duration and recorder time-stamp and uncertainty

	Measuring Range	Resolution	Error
Event Duration	10 ms ÷ 7 days	1 ms	± 1 cycle
Record and Event Time stamp	N/A	1 ms	± 1 cycle

6.2.21 Temperature probe

Measuring range	Resolution	Accuracy
-10.0 °C ÷ 85.0 °C	0.1 °C	± 0.5 °C
-20.0 °C ÷ -10.0 °C and 85.0 °C ÷ 125.0 °C		± 2.0 °C

6.2.22 Phase angle

Measuring range	Resolution	Accuracy
-180.0° ÷ 180.0°	0.1°	± 0.6°

6.2.23 400Hz systems specification

Sampling frequency:	Normal operation Antialiasing filter	12,2 kSamples/sec Passband (-3dB): 0 ÷ 5,7kHz Stopband (-80dB): > 6,44 kHz
Cycle aggregation:	50 cycles	

6.2.24 VFD (Variable frequency drive) systems specification

Sampling frequency:	Normal operation Antialiasing filter	1,7 kSamples/sec Passband (-3dB): 0 ÷ 782 Hz Stopband (-80dB): > 883 Hz
Cycle aggregation:	5 cycles	

6.2.25 Differences in specification between 400Hz, VFD and 50/60 Hz systems

Measurement / Recording	MI 2893 - 400Hz	MI 2893- VFD	MI 2893 - 50 Hz / 60Hz
Voltage	• ⁽¹⁾	• ⁽¹⁾	•

Current	● ⁽¹⁾	● ⁽¹⁾	●
Frequency	335 Hz ÷ 465 Hz	5 Hz ÷ 110 Hz	●
Power	● ⁽¹⁾	● ⁽¹⁾	●
Energy	● ⁽¹⁾	● ⁽¹⁾	●
Unbalance	● ⁽¹⁾	● ⁽¹⁾	●
Flicker	-	-	●
THD	●	●	●
Voltage Harmonics	0 ÷ 13 th	0 ÷ 20 th ⁽³⁾	0 ÷ 50 th
Current Harmonics	0 ÷ 13 th	0 ÷ 20 th ⁽³⁾	0 ÷ 50 th
Voltage Interharmonics	-	0 ÷ 20 th ⁽³⁾	1 ÷ 50 th
Current Interharmonics	-	0 ÷ 20 th	1 ÷ 50 th
Events	● ⁽¹⁾	● ⁽¹⁾	●
RVC - Rapid Voltage Changes	-	● ⁽¹⁾	●
Signalling	-	-	●
Network Configurations	● ⁽¹⁾	● ⁽¹⁾	●
General recorder	● ⁽¹⁾	● ⁽¹⁾	●
Waveform / inrush recorder	● ⁽¹⁾	● ⁽¹⁾	●
Transient recorder	● ⁽¹⁾	● ⁽¹⁾	●
Waveform Snapshot	● ⁽¹⁾	● ⁽¹⁾	●
Cycle aggregation	50 cycles	5 cycles	10/12 cycles

⁽¹⁾ Identical technical specification (accuracy, measurement ranges, etc) as on 50Hz/60Hz systems

⁽²⁾ On 3-phase 4-wire systems measurement are performed on 3 voltage and 4 current channels, channel

U_{N-GND} is not used.

⁽³⁾ Number of harmonics depends on voltage/current frequency 5÷16Hz – 20 harmonics, 16÷33Hz 13 harmonics, 33 ÷ 110Hz 5 harmonics

6.3 Recorders

6.3.1 General recorder

Sampling	According to the IEC 61000-4-30 Class A requirements. The basic measurement time interval for voltage, harmonics, interharmonics and unbalance is 10-cycle time interval for a 50 Hz power system and 12-cycle time interval for a 60 Hz power system. Instrument provides approximately 3 readings per second, continuous sampling. All channels are sampled simultaneously. For harmonics measurement input samples are resampled, in order to assure that sampling frequency is continuously synchronized with main frequency.
Recording quantities	Voltage, current, frequency, crest factors, power, energy, 50 harmonics, 50 interharmonics, flickers, signalling, unbalance, under and over deviation. See section 4.4 for details which minimum, maximum, average and active average values are stored for each parameter.
Recording interval	1 s, 3 s (150 / 180 cycles), 5 s, 10 s, 1 min, 2 min, 5 min, 10 min, 15 min, 30 min, 60 min, 120 min.
Events	All events, without limitation can be stored into record.
Alarms	All alarms, without limitation can be stored into record.
Signalling	Signalling events, without limitation can be stored into record.
Transients	Transients, without limitation can be stored into record.
Inrush	Inrush currents, without limitation can be stored into record.
RVC	RVC, without limitation can be stored into record.
200 ms U/I/f	200 ms U/I/f Snapshot can be stored into record (every 60 minutes).
Trigger	Predefined start time or manual start.

Note: If during record session instrument batteries are drained, due to long interruption for example, instrument will shut down and after electricity comes back, it will automatically restart recording session.

Table 138: General recording max. duration

Recording interval	Max. record duration*
1 s	12 hours
3 s (150 / 180 cycles)	2 days
5 s	3 days
10 s	7 days
1 min	30 days
2 min	60 days
5 min	
10 min	
15 min	
30 min	> 60 days
60 min	
120 min	

*At least 2 GB of free space should be available on microSD card.

Note: Recorder file size is limited to 2 GB due to the easiest large file import / transfer into PowerView.

6.3.2 Waveform/inrush recorder

Sampling	7 kSamples/s, continuous sampling per channel. All channels are sampled simultaneously.
Recording time	From 1 sec to 60 seconds.
Recording type	Continuous – consecutive waveform recording until user stops the measurement or instrument runs out of storage memory. Max. 1500 records can be stored per session. Default setting is 200 records, more than 200 records can slow down the instrument.
Recording quantities	Waveform samples of: $U_1, U_2, U_3, U_N, (U_{12}, U_{23}, U_{31}), I_1, I_2, I_3, I_N$
Trigger	Voltage or current level, voltage events, alarms defined in alarm table or manual trigger.

6.3.3 Waveform snapshot

Sampling	7 kSamples/s, continuous sampling per channel. All channels are sampled simultaneously.
Recording time	10/12 cycle period.
Recording quantities	Waveform samples of: $U_1, U_2, U_3, U_N, (U_{12}, U_{23}, U_{31}), I_1, I_2, I_3, I_N$, all measurements.
Trigger	Manual

6.3.4 Transients recorder

Sampling	1 MSamples/s, continuous sampling per channel. All channels are sampled simultaneously.
Recording time	One cycle period.
Recording quantities	Waveform samples of: $U_1, U_2, U_3, U_N, (U_{12}, U_{23}, U_{31}), I_1, I_2, I_3, I_N$
Trigger:	Transient selection measurement between N/GND Envelope and level trigger simultaneously- for details see section 5.1.20

6.4 Standards compliance

6.4.1 Compliance to the IEC 61557-12

General and essential characteristics

Power quality assessment function	-A
Classification according to 4.3	SD Indirect current and direct voltage measurement
	SS Indirect current and indirect voltage measurement
Temperature	K50
Humidity + altitude	Standard

Measurement characteristics

Function symbols	Class according to IEC 61557-12	Measuring range
P	1	2 % ÷ 200% $I_{Nom}^{(1)}$
Q	1	2 % ÷ 200% $I_{Nom}^{(1)}$
S	1	2 % ÷ 200% $I_{Nom}^{(1)}$
Ep	1	2 % ÷ 200% $I_{Nom}^{(1)}$
Eq	2	2 % ÷ 200% $I_{Nom}^{(1)}$
eS	1	2 % ÷ 200% $I_{Nom}^{(1)}$
PF	0.5	- 1 ÷ 1
I, I_{Nom}	0.2	2 % I_{Nom} ÷ 200 % I_{Nom}
I_{h_n}	1	0 % ÷ 100 % I_{Nom}
THD _i	2	0 % ÷ 100 % I_{Nom}

(1) – Nominal current depends on current sensor.

6.4.2 Compliance to the to the IEC 61000-4-30

IEC 61000-4-30 Section and Parameter	Power Master XT Measurement	Class
4.4 Aggregation of measurements in time intervals* <ul style="list-style-type: none"> • aggregated over 150/180-cycle • aggregated over 10 min • aggregated over 2 h 	Timestamp, Duration	A
4.6 Real time clock (RTC) uncertainty		A
4.7 Flagging		A
5.1 Frequency	Freq	A
5.2 Magnitude of the Supply	U	A
5.3 Flicker	P_{st}, P_{It}	A
5.4 Dips and Swells	$U_{Dip}, U_{Swell}, \text{duration}$	A
5.5 Interruptions	duration	A
5.7 Unbalance	u^-, u^0	A
5.8 Voltage Harmonics	$U_{h_{0+50}}$	A
5.9 Voltage Interharmonics	$U_{ih_{0+50}}$	A
5.10 Mains signalling voltage	U_{Sig}	A
5.12 Underdeviation and overdeviation	U_{Under}, U_{Over}	A

* Instrument aggregate measurement according to selected **Interval:** parameter in GENERAL RECORDER. Aggregated measurements are shown in TREND screens, only if GENERAL RECORDER is active.

7 Maintenance

7.1 Inserting batteries into the instrument

1. Make sure that the power supply adapter/charger and measurement leads are disconnected and the instrument is switched off before opening battery compartment cover.
2. Insert batteries as shown in figure below (insert batteries correctly, otherwise the instrument will not operate and the batteries could be discharged or damaged).



Figure 166: Battery compartment

1	Battery cells
2	Serial number label

3. Turn the instrument upside down (*see figure below*) and put the cover on the batteries.



Figure 167: Closing the battery compartment cover

4. Screw the cover on the instrument.

Warnings!

- Hazardous voltages exist inside the instrument. Disconnect all test leads, remove the power supply cable and turn off the instrument before removing battery compartment cover.
- Use only power supply adapter/charger delivered from manufacturer or distributor of the equipment to avoid possible fire or electric shock.
- Do not use standard batteries while power supply adapter/charger is connected, otherwise they may explode!
- Do not mix batteries of different types, brands, ages, or charge levels.
- When charging batteries for the first time, make sure to charge batteries for at least 24 hours before switching on the instrument.

Notes:

- Rechargeable NiMH batteries, type HR 6 (size AA), are recommended. The charging time and the operating hours are given for batteries with a nominal capacity of 2000 mAh.
- If the instrument is not going to be used for a long period of time remove all batteries from the battery compartment. The enclosed batteries can supply the instrument for approx. 5 hours.

7.2 Batteries

Instrument contains rechargeable NiMH batteries. These batteries should only be replaced with the same type as defined on the battery placement label or in this manual.

If it is necessary to replace batteries, all six have to be replaced. Ensure that the batteries are inserted with the correct polarity; incorrect polarity can damage the batteries and/or the instrument.

Precautions on charging new batteries or batteries unused for a longer period

Unpredictable chemical processes can occur during charging new batteries or batteries that were unused for a longer period of time (more than 3 months). NiMH and NiCd batteries are affected to a various degree (sometimes called as memory effect). As a result, the instrument operation time can be significantly reduced at the initial charging/discharging cycles.

Therefore, it is recommended:

- To completely charge the batteries

- To completely discharge the batteries (can be performed with normal working with the instrument).
- Repeating the charge/discharge cycle for at least two times (four cycles are recommended).

When using external intelligent battery chargers one complete discharging /charging cycle is performed automatically.

After performing this procedure, a normal battery capacity is restored. The operation time of the instrument now meets the data in the technical specifications.

Notes:

The charger in the instrument is a pack cell charger. This means that the batteries are connected in series during the charging so all batteries have to be in similar state (similarly charged, same type and age).

Even one deteriorated battery (or just of another type) can cause an improper charging of the entire battery pack (heating of the battery pack, significantly decreased operation time).

If no improvement is achieved after performing several charging/discharging cycles the state of individual batteries should be determined (by comparing battery voltages, checking them in a cell charger etc). It is very likely that only some of the batteries are deteriorated.

The effects described above should not be mixed with normal battery capacity decrease over time. All charging batteries lose some of their capacity when repeatedly charged/discharged. The actual decrease of capacity versus number of charging cycles depends on battery type and is provided in the technical specification of batteries provided by battery manufacturer.

7.3 Firmware upgrade

Metrel as manufacturer is constantly adding new features and enhance existing. In order to get most of your instrument, we recommend periodic check for software and firmware updates. In this section firmware upgrade process is described.

7.3.1 Requirements

Firmware upgrade process has following requirements:

- **PC computer** with installed latest version of PowerView software. If your PowerView is out of date, please update it, by clicking on "Check for PowerView updates" in Help menu, and follow the instructions
- **USB cable**

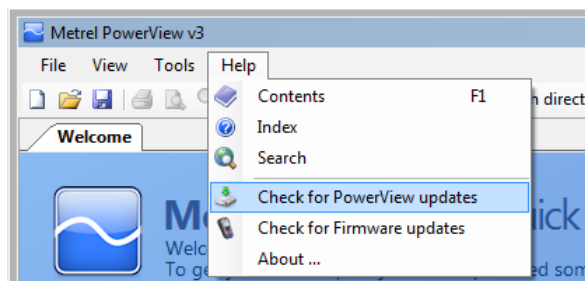

Figure 168: PowerView update function

7.3.2 Upgrade procedure

1. Connect PC and instrument with USB cable

- Establish USB communication between them. In PowerView, go to Tools → Options menu and set USB connection as shown on figure below.

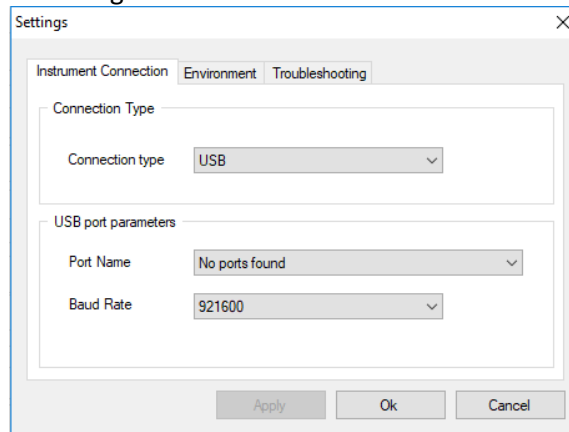

Figure 169: Selecting USB communication

- Click on Help → Check for Firmware updates.

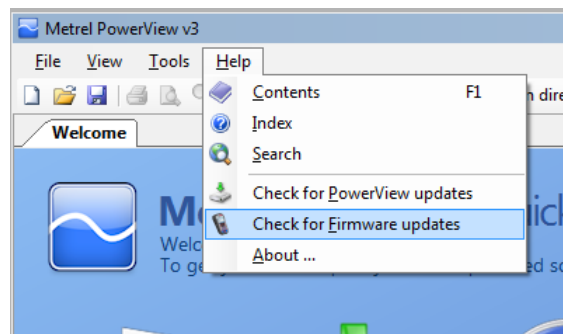

Figure 170: Check for Firmware menu

- Version checker window will appear on the screen. Click on Start button.

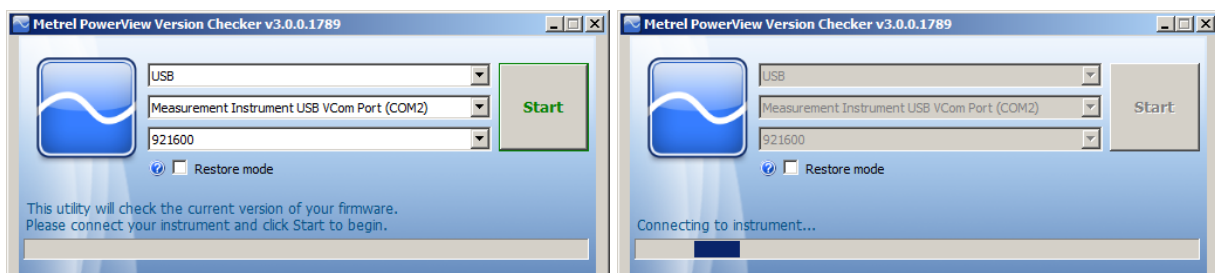

Figure 171: Check for Firmware menu

- If your instrument has older FW, PowerView will notify you that new version of FW is available. Click on Yes to proceed.

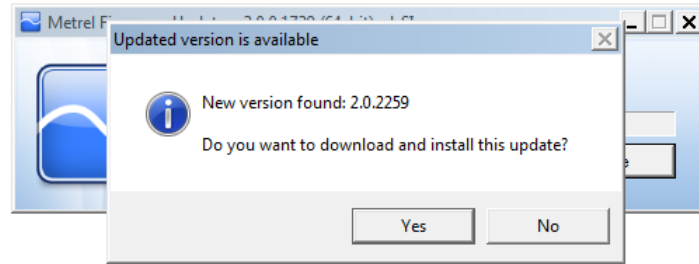

Figure 172: New firmware is available for download

6. After update is downloaded, FlashMe application will be launched. This application will actually upgrade instrument FW. Click on RUN to proceed.

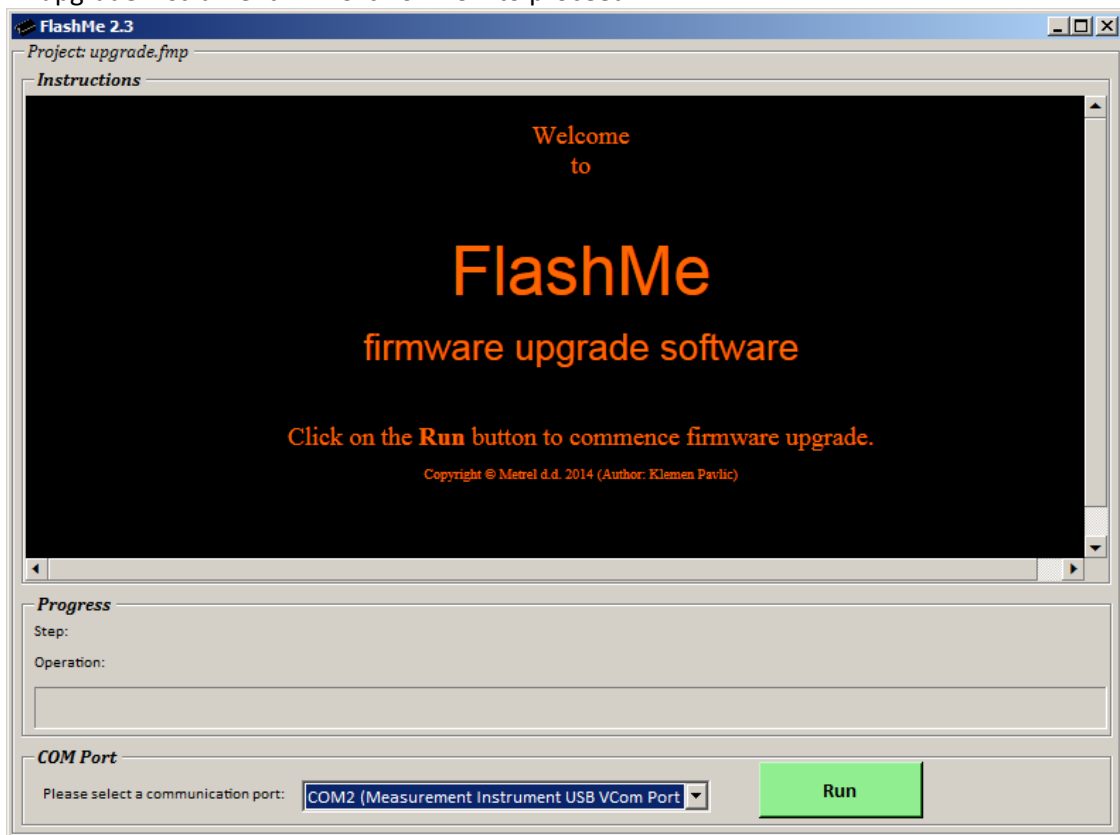

Figure 173: FlashMe firmware upgrade software

7. FlashMe will automatically detect Power Master XT instrument, which can be seen in COM port selection menu. In some rare cases user should point FlashMe manually to COM port where instrument is connected. Click then on Continue to proceed.



Figure 174: FlashMe configuration screen

- Instrument upgrade process should begin. Please wait until all steps are finished. Note that this step should not be interrupted; as instrument will not work properly. If upgrade process goes wrong, please contact your distributor or Metrel directly. We will help you to resolve issue and recover instrument.

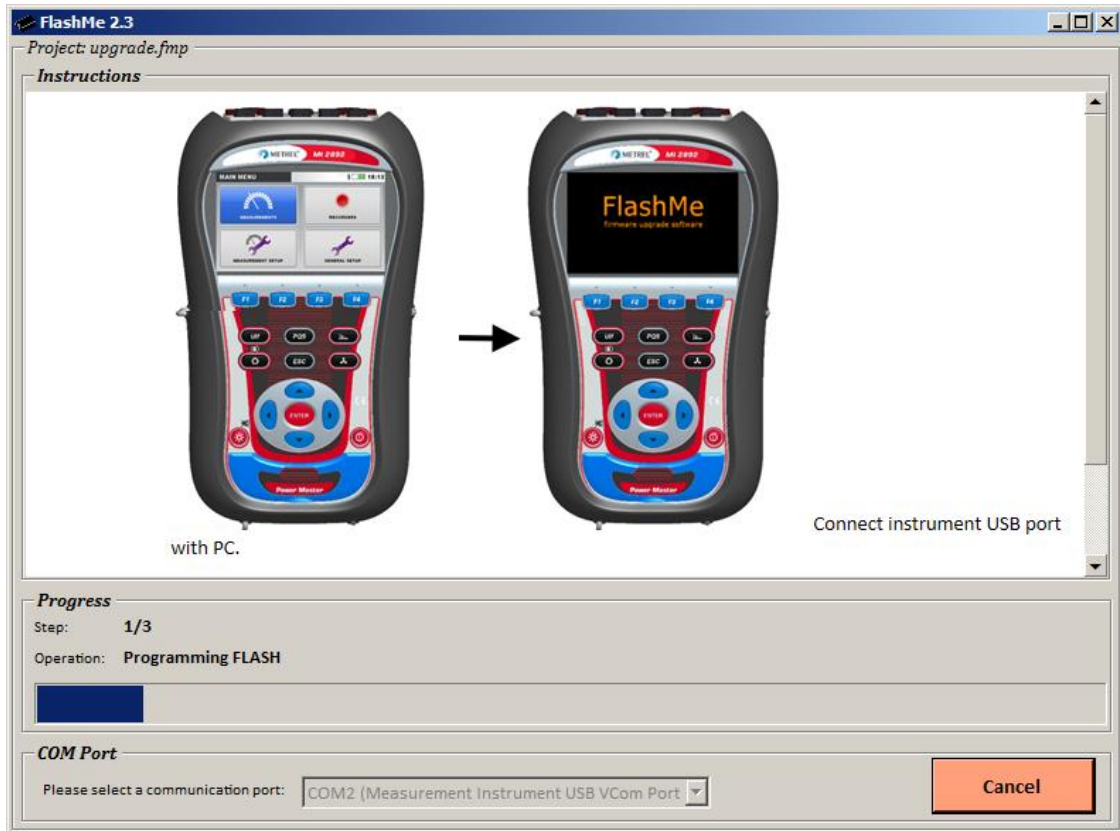

Figure 175: FlashMe programming screen

7.4 Power supply considerations

⚠ Warnings

- Use only charger supplied by manufacturer.
- Disconnect power supply adapter if you use standard (non-rechargeable) batteries.

When using the original power supply adapter/charger the instrument is fully operational immediately after switching it on. The batteries are charged at the same time, nominal charging time is 3.5 hours. The batteries are charged whenever the power supply adapter/charger is connected to the instrument. Inbuilt protection circuit controls the charging procedure and assure maximal battery lifetime. Batteries will be charged only if their temperature is less than 40 °C.

If the instrument is left without batteries and charger for more than 2 minutes, time and date settings are reset.

7.5 Cleaning

To clean the surface of the instrument, use a soft cloth slightly moistened with soapy water or alcohol. Then leave the instrument to dry totally before use.

⚠ Warnings

- Do not use liquids based on petrol or hydrocarbons!
- Do not spill cleaning liquid over the instrument!

7.6 Periodic calibration

To ensure correct measurement, it is essential that the instrument is regularly calibrated. If used continuously on a daily basis, a six-month calibration period is recommended, otherwise annual calibration is sufficient.

7.7 Service

For repairs under or out of warranty please contact your distributor for further information.

7.8 Troubleshooting

If ESC button is pressed while switching on the instrument, the instrument will not start. Batteries have to be removed and inserted back. After that the instrument will start normally.

8 Version of document

#	Document version	Description of changes
1	1.1.1	- First official version
2	1.2.2	- Corrections related the current measurement range vs current CF - U/I/f Snapshot recording option for General Recorder - Added Status bar icons

Manufacturer address:

METREL d.d.
Ljubljanska 77,
SI-1354 Horjul,
Slovenia

Tel: +(386) 1 75 58 200
Fax: +(386) 1 75 49 095
Email: metrel@metrel.si
<http://www.metrel.si>