

Hygrostat HST

KEY POINTS

- Measuring range from de 5 to 95%HR and from 0 to 50 °C (ambient model) or from -20 to +80 °C (duct and remote model)
- RCR relay output 3A/230 Vac, power supply 24 Vac/Vdc
- Visual and audible alarm configurable on one or two parameters, red led in front
- ABS V0 IP65 housing (duct and remote model) or IP20 (ambient model)
- Alternating display of humidity and temperature
- "¼ turn" system mounting with wall-mount plate
- Housing with simplified mounting system



FEATURES OF THE HOUSING

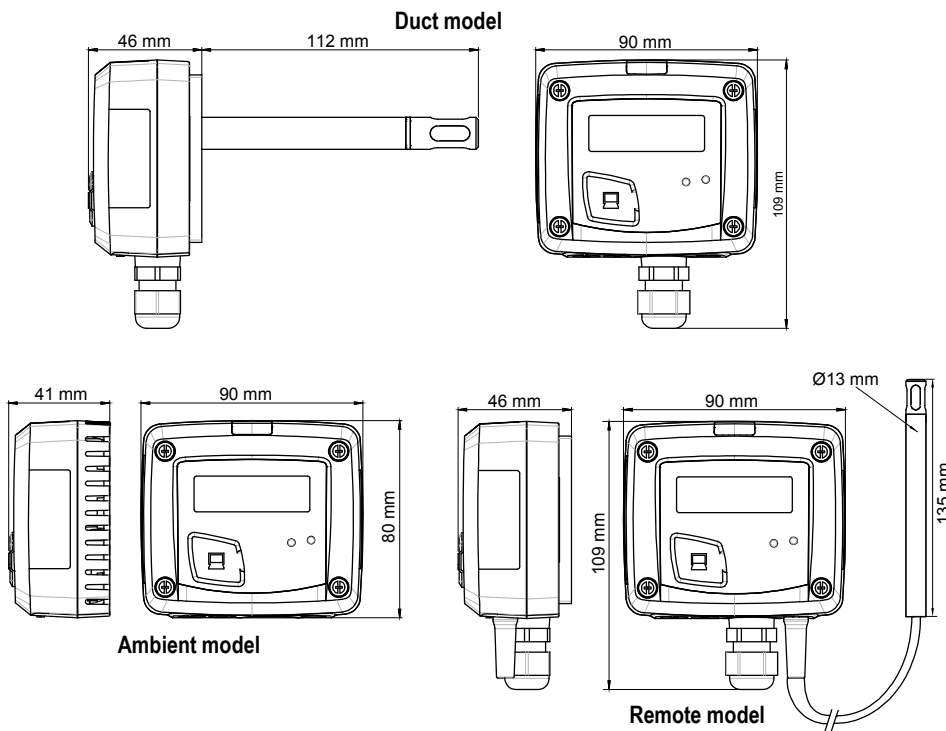

Material

ABS V0 as per UL94

Protection

IP65 (duct and remote models)
IP20 (ambient model)

Display

LCD 10 digits. Size: 50 x 17 mm
Alternating display of humidity and temperature

Height of digits

Values: 10 mm
Units: 5 mm

Cable gland (duct and remote models)

For cables Ø 8 mm maximum

Weight

124 g (ambient model) ; 135 g (duct and remote models)

Cable of remote probes: length 2 m and Ø 4.8 mm in silicone

PART NUMBER

To order, just add the codes to complete the part number :

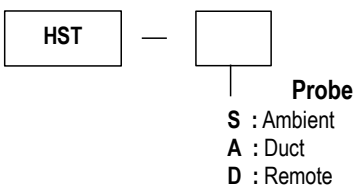

Example : HST – A
Hygrostat HST with duct probe

TECHNICAL FEATURES IN TEMPERATURE

Measuring range	Ambient model: from 0 to 50 °C Duct and remote models: from -20 to +80 °C
Accuracy*	Ambient model: ± 0.4 % of reading ± 0.3 °C Duct and remote models: ± 0.3 °C (from -40°C to 70°C) ; ± 0.5 °C outside
Unit of measurement	°C / °F
Response time	1/e (63%) 15 s
Type of sensor	NTC
Resolution	0.1 °C
Type of fluid	Air and neutral gases

TECHNICAL FEATURES IN HUMIDITY

Measuring range	from 5 to 95% RH
Accuracy*	± 1.5 % HR (if $15^{\circ}\text{C} \leq T \leq 25^{\circ}\text{C}$) on duct and remote models ± 2 % HR (if $15^{\circ}\text{C} \leq T \leq 25^{\circ}\text{C}$) on ambient model
Drift linked to temperature	$\pm 0.04 \times (T-20)$ %RH (if $15^{\circ}\text{C} \leq T \leq 25^{\circ}\text{C}$)
Unit of measurement	% RH
Response time	1/e (63%) 4 s
Type of sensor	Capacitive
Resolution	0.1% RH
Factory adjustment uncertainty	± 0.88 % RH
Type of fluid	Air and neutral gases

*All the accuracies indicated in this technical datasheet were stated in laboratory conditions, and can be guaranteed for measurements carried out in the same conditions, or carried out with calibration compensation.

TECHNICAL SPECIFICATIONS

Output

1 RCR relay 3 A / 230 VAC
Common mode voltage <30 VAC

Power supply

24 VAC/VDC ± 10 %

Consumption

3 VA

Relay and alarm status

Red led in front and internal buzzer

European directives

2004/108/EC EMC
2006/95/EC Low Voltage
2011/65/EU RoHS II
2012/19/EU WEEE

Electrical connection

Terminal block for cables $\varnothing 0.05$ to 2.5 mm²
Carried out according to the code of good practice

PC communication

USB-mini Din cable

Environment

Air and neutral gases

Conditions of use (°C/%RH/m)

From 0 to +50 °C. In non-condensing condition.
From 0 to 2000 m.

Operating temperature of the probe

From -20 to +80 °C

Storage temperature

From -10 to +70 °C

CONNECTIONS

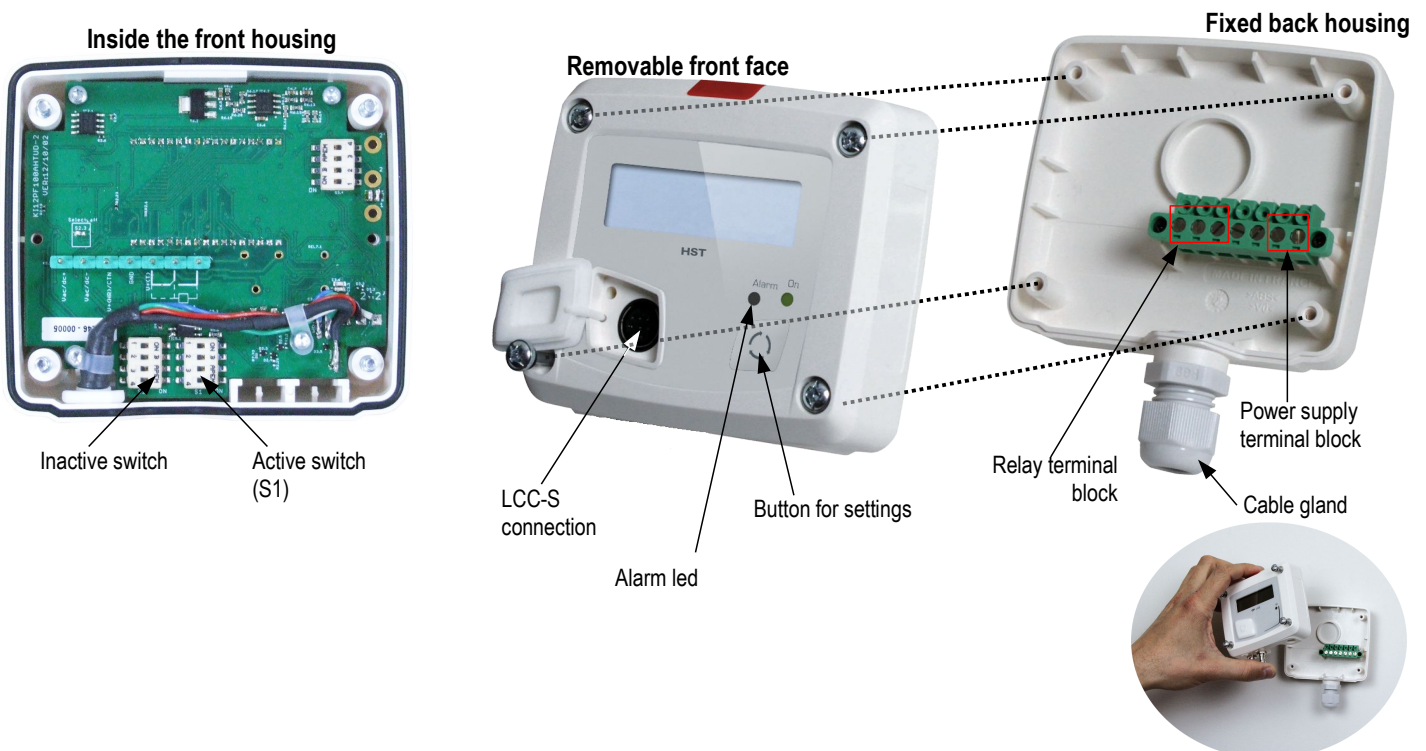



This connection must be made by a qualified technician. **To make the connection, the transmitter must not be energized.**

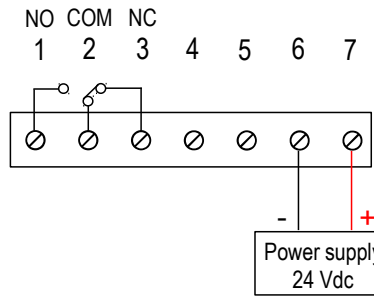

or

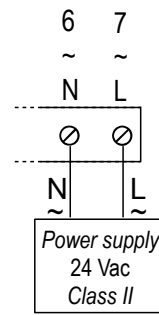

SETTINGS AND USE OF THE TRANSMITTER

> Configuration

It is possible to set the unit of the transmitter either by switch and/or via software.



To configure the transmitter, it must not be energized. Then, you can make the settings required, with the DIP switches (as shown on the drawing below). When the transmitter is configured, you can power it up.

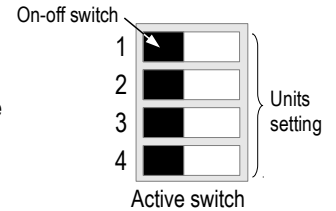

- **Configuration by switch** : to configure the transmitter, unscrew the 4 screws from the housing then open it.



Please follow carefully the combinations beside with the DIP switch. If the combination is wrongly done, the following message will appear on the display of the transmitter "CONF ERROR". In that case, you will have to unplug the transmitter, place the DIP switches correctly, and then power the transmitter up.

> Units setting – active switch

To set a unit of measurement, put the on-off switch 4 of the units as shown beside.

Configurations	°C	°F
Combinations	1	1
	2	2
	3	3
	4	4

SETTINGS AND USE OF THE TRANSMITTER

> Threshold configuration

The button allows to activate or not an alarm (threshold), to set the action of the alarm (edge), to set the threshold(s) value, to set the time-delay and to acknowledge the alarm.

Working principle:

- By pressing on the button more than 3 seconds, you can validate the setting and go to the next setting.
- By pressing quickly on the button, you can increment a value and scroll down the different option or values.

Setting procedure:

- **Activate or deactivate an alarm:**
 - > Press on the button for 3 seconds, "CONF" is displayed then "NEG", meaning that the relay is in negative security, it is excited during an alarm condition.
 - > If needed, press quickly on the button to switch the relay in positive security, the relay is de-energized during an alarm condition or a current breaking, "POS" is displayed.
 - > Press 3 s on the button, "Buzz" screen is displayed with "ON" or "OFF" blinking. Briefly press on the button to activate ("ON") or deactivate ("OFF") (according to the last saved configuration) the buzzer during an alarm condition.
 - > Press 3 s on the button, "Alarm" screen is displayed with "On" or "Off" blinking (according to the last saved configuration).
 - > Press quickly on the button, the display changes from "On" (activated alarm) to "Off" (deactivated alarm).
 - > Press 3 seconds on the button to confirm the setting. If the alarm is deactivated, the instrument displays the measurement ; if the alarm is activated, the instrument displays the following setting.

- **Set the action of the alarm (rising edge or falling edge)**

The edge determines the action of the alarm according to the trespassing direction of the threshold(s).

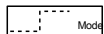

Rising edge (1 threshold) : the alarm goes off when the measurement **exceeds** the threshold and stops when it is **below** the threshold.

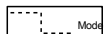

Falling edge (1 threshold) : the alarm goes off when the measurement is **below** the threshold and stops when it **exceeds** the threshold.

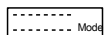

Monitoring (2 thresholds) : the alarm goes off when the measurement is outside the defined low and high thresholds.

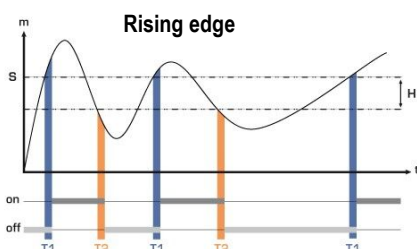

Measurement (m) > Threshold (S) during the time-delay $T1$ → Alarm activation.
Measurement (m) < Threshold (S) - Hysteresis (H) during the time-delay $T2$ → Alarm deactivation.

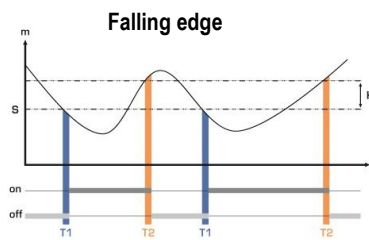

Measurement (m) < Threshold (S) during the time-delay $T1$ → Alarm activation.
Measurement (m) > Threshold (S) + Hysteresis (H) during time-delay $T2$ → Alarm deactivation.

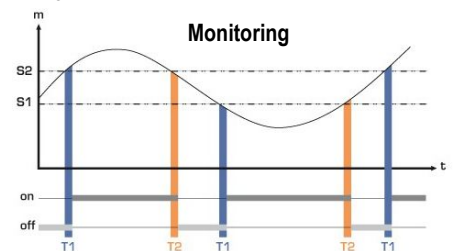

The alarm goes off when the measurement is outside the low and high thresholds.

➢ Press briefly on the button to select the trespassing direction then press the button more than 3 seconds to validate this direction and set the thresholds.

• **Set the threshold(s) value**

The first digit blinks, it corresponds to the positive (0) or negative (-) setting of the threshold value. Press briefly on the button to select the sign for the threshold value. Press on the button more than 3 seconds to validate.

The second digit blinks, press briefly on the button to scroll the numbers. Press the button more than 3 seconds to validate.

Repeat the process until the last digit to configure the threshold value, validate the threshold and go to the following setting.

If the monitoring edge has been selected, the transmitter displays the setting of the second threshold.

• **Set the hysteresis**

The hysteresis is only for the rising edge and the falling edge modes.

In rising edge mode, the hysteresis allows to the transmitter to stay in alarm when the measurement is between the threshold and the threshold minus the hysteresis.

Ex : for a 50%RH threshold and a 10%RH hysteresis, the instrument will stay in alarm when the measurement will be between 50 and 40%RH.

In falling edge mode, the hysteresis allows to the transmitter to stay in alarm when the measurement is between the threshold and the threshold plus the hysteresis.

Ex : for a 100%RH threshold and a 10%RH hysteresis, the instrument will stay in alarm when the measurement will be between 100 and 110%RH.

The first digit blinks, set it pressing the button briefly several times then press on the button more than 3 seconds to set the following digit.

Once the hysteresis is set, press the button more than 3 seconds to validate and set the time-delays.

• **Set the time-delay 1 and the time-delay 2 (600 seconds maximum)**

➢ In rising edge mode, the time-delay 1 corresponds to the time lag before the alarm goes off when the threshold has been reached. The time-delay 2, corresponds to the time lag before the alarm stops when the measurement is lower than the threshold minus the hysteresis.

Setting procedure : “Time 1” for the time-delay 1 is displayed then the time in second. The first digit blinks, press briefly on the button and scroll the figures. Press on the button more than 3 seconds to validate. Repeat the process until the last digit to set the time-delay 1 value (from 0 to 600 s) and validate. “Time 2” is displayed the the time in second. Repeat the process to set the time-delay 2.

➢ In falling edge mode, the time-delay 1 corresponds to the time lag before the alarm goes off when the threshold has been reached. The time-delay 2, corresponds to the time lag before the alarm stops when the measurement is lower than the threshold plus the hysteresis.

The setting procedure is the same as the rising edge procedure.

➢ In monitoring mode, the alarm of the transmitter goes off when the measurement is below the lower threshold and higher the high threshold. The time-delay 1 corresponds to the time lag before the alarm goes off when the measurement is below the lower threshold and higher the high threshold. The time-delay 2 corresponds to the time lag before the alarm stops when the measurement is between the lower and higher thresholds.

The setting procedure is the same as the rising edge procedure.

The setting of time delays is done, the measurement is displayed.

CONFIGURATION VIA LCC-S SOFTWARE (option)

The software allows to set the alarms, the thresholds, and the time-delay of the transmitter.

- To access the configuration via software :
 - Set the DIP switches as shown beside.
 - Connect the cable of the LCC-S to the connection of the transmitter.
- Please refer to the user manual of the LCC-S to make the configuration.

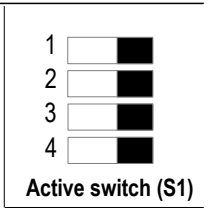

The configuration of the parameters can be done either with the DIP switch or via software (you can not combine both solutions)

MOUNTING

To mount the transmitter, mount the ABS plate on the wall (drilling : Ø6 mm, screws and pins are supplied).

Insert the transmitter on the fixing plate (see A on the drawing beside). Rotate the housing in clockwise direction until you hear a “click” which confirms that the transmitter is correctly installed.



Ambient model does not have any mounting plate.
4 fixing holes are present inside the back housing. Use them to install the transmitter on the required location.

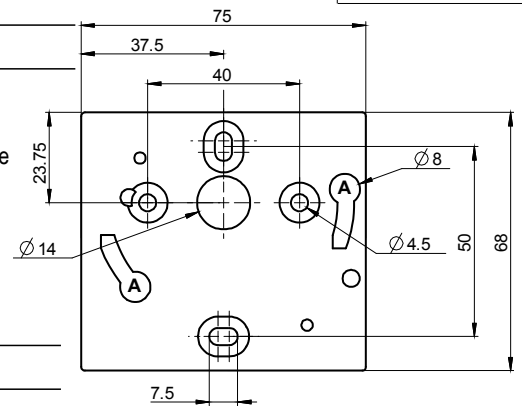

MAINTENANCE

Please avoid any aggressive solvent. Please protect the transmitter and its probes from any cleaning product containing formalin, that may be used for cleaning rooms or ducts.

OPTIONS AND ACCESSORIES

- **KIAL-100A** : Power supply class 2, 230 Vac input, 24 Vac output
- **LCC-S** : configuration software with USB cable
- Stainless steel sliding fittings
- PC cable gland
- ABS connection with connection gland
- Stainless steel connections
- Wall-mount plate for humidity remote probe

Only the accessories supplied with the device must be used.

PRECAUTIONS FOR USE

Please always use the device in accordance with its intended use and within parameters described in the technical features in order not to compromise the protection ensured by the device.



Once returned to KIMO, required waste collection will be assured in the respect of the environment in accordance with European guidelines relating to WEEE.

www.kimo.fr

Distributed by :



EXPORT DEPARTMENT
 Tel : + 33. 1. 60. 06. 69. 25 - Fax : + 33. 1. 60. 06. 69. 29
 e-mail : export@kimo.fr