



HM-AP56-W/W-AI56

Acoustic imaging camera

The HIKMICRO AI56 acoustic imaging camera is a professional product for sound source localization. With 64 Low-noise MEMS microphones and adjustable bandwidth range from 20 Hz to 60 kHz, AI56 provides an easy and effective way to locate the pressurized air leaks in industrial environments or detecting partial discharge in high-voltage systems. By using a large 4.3" LCD touch screen, the results presented on top of a digital picture allows you to quickly find the source of the problems. The maximum operating distance could reach 100 meters, which can ensure you stay at a safe distance to inspect the high-voltage equipment. Adopting this lightweight and easy-to-use tool, you can discover the potential safety risks, minimize troubleshooting, and save extra costs of equipment failures and downtime.

Key Features

- **64 Low-noise MEMS microphones, real-time sound visualization**
- **Supports multiple palettes**
- **High quality optical module with 5 MP resolution**
- **High-calibre 800 × 480 resolution 4.3" LCD touch display**
- **Supports 1.0x to 8.0x continuous digital zoom**

Specification

ACOUSTIC SPECIFICATIONS	
NUMBER OF MICROPHONES	64
BANDWIDTH	2 kHz to 60 kHz
DISTANCE	0.3 m to 100 m
ACOUSTIC IMAGE PALETTE	8: White Black, Black White, Rainbow, Fusion, Ironbow, Red Black, Rain, Blue Red
SOUND INTENSITY DISPLAY	Peak Point, Center Point
ACOUSTIC DETECTION MODE	Partial Discharge Detection, Gas Leakage Detection
ACOUSTIC IMAGE FRAME RATE	25 fps
OPTICAL MODULE	
BUILT-IN VISUAL CAMERA	2688 × 1944 (5 MP)
FOV (FIELD OF VIEW)	51.8° (H) × 36.4° (V)
PICTURE RESOLUTION	800 × 480
VIDEO RESOLUTION	800 × 480
FOCAL LENGTH	6.4 mm
IMAGE DISPLAY	
DISPLAY	800 × 480 Resolution, 4.3" LCD Touch Screen
SCREEN BRIGHTNESS	Manual/Automatically adjust
POWER SAVING MODE	Standby Mode, off
DIGITAL ZOOM	1.0x to 8.0x continuous
STORAGE	
STORAGE MEDIA	Default Storage: Removable SD Card (64 GB); Max. Storage Capacity: 128 GB
IMAGE STORAGE CAPACITY	20,000 Images
VOICE NOTE	Max. 60 Seconds
TEXT NOTE	Max. 200 Characters
VIDEO STORAGE CAPACITY	60 Hours
VIDEO FILE FORMAT	MP4
POWER SYSTEM	
POWER SUPPLY	12 VDC/1.5 A, 5 VDC/2A (Charging via USB)
POWER CONSUMPTION	5.8 W
BATTERY TYPE	Dismountable and Rechargeable Li-ion Battery

BATTERY OPERATING TIME	3.5 Hours Continuous Running
BATTERY CHARGING TIME	4 hours to full charge
BATTERY CHARGING SYSTEM	Two-bay battery charger or in-imager charging, fast charging
AC OPERATION	AC operation with included power supply (100 VAC to 240 VAC, 50/60 Hz)
GENERAL	
WI-FI	802.11 b/g/n (2.4 GHz and 5 GHz)
USB INTERFACE	USB Type-C
SD CARD INTERFACE	SD card
HDMI INTERFACE	HDMI-D
PROTECTION LEVEL	IP40
DROP TEST HEIGHT	1.2 m (3.94 ft)
WARRANTY	3 years for full product and 2 years for battery
VIBRATION	0.03 g ² /Hz (3.8 g), 2.5 g IEC 60068-2-6
SHOCK	25 g, IEC 68-2-29
WORKING TEMPERATURE RANGE	-20°C to 50°C (-4°F to 122°F)
STORAGE TEMPERATURE RANGE	-20°C to 60°C (-4°F to 140°F)
RELATIVE HUMIDITY	< 95% non-condensing
WEIGHT	Approx. 940 g (2.07 lb)
DIMENSION	292.2 mm × 127 mm × 110.7 mm (11.50" × 5.00" × 4.36")
TRIPOD MOUNTING	UNC ¼"-20
MENU LANGUAGE	21 Languages English, German, French, Spanish (Spain), Portuguese (Portugal), Italian, Czech, Slovak, Polish, Hungarian, Romanian, Dutch, Danish, Norwegian, Finnish, Swedish, Russian, Turkish, Japanese, Korean, Chinese (Traditional)

Please note that product specifications are subject to change without notice. Please check <https://www.hikmicrotech.com> for the latest changes.

Ordering Model

HM-AP56-W/W-AI56

Dimension

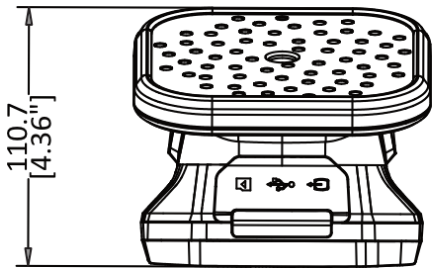
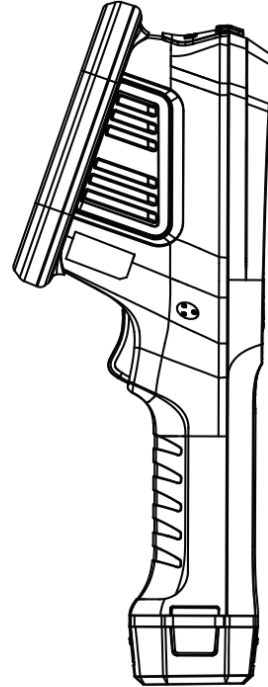
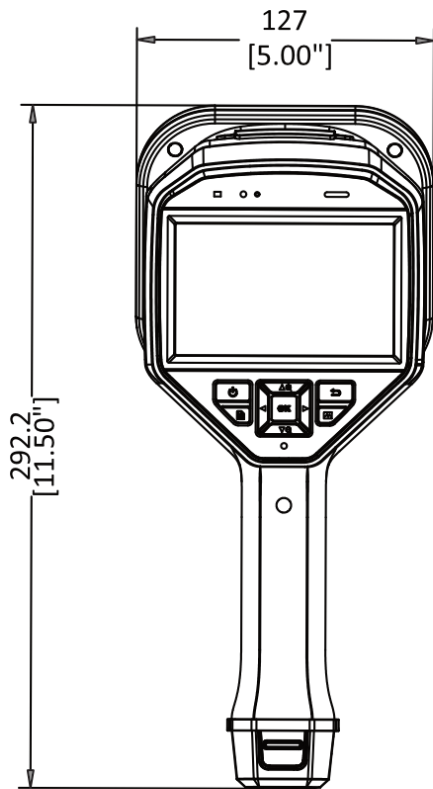

Unit: mm (Inch)

Packing List



**Acoustic Imaging
Camera (× 1)**

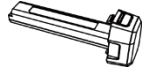

Battery (× 2)

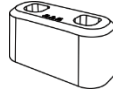

Charging Base (× 1)

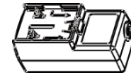

**Power
Adapter (× 1)**

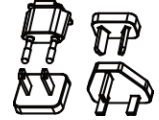

Adapter (× 4)



Hand Strap (× 1)



USB Cable (× 1)



HDMI Cable (× 1)



SD Card (× 1)



**MIC Protective Case (×
1)**



Accessories Bag (× 1)



Quick Start Guide (× 1)

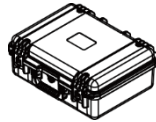

Carrying Case (× 1)

