



GF GL GP

Earth Analyser
MI 3290
Instruction manual
Version 1.1.2, Code No. 20 752 597

Distributor:

Manufacturer:

METREL d.d.
Ljubljanska cesta 77
1354 Horjul
Slovenia
web site: <http://www.metrel.si>
e-mail: metrel@metrel.si



Mark on your equipment certifies that it meets European Union requirements for EMC, LVD, ROHS regulations.

© 2016 METREL

The trade names Metrel, Smartec, Eurotest, Autosequence are trademarks registered or pending in Europe and other countries.
No part of this publication may be reproduced or utilized in any form or by any means without permission in writing from METREL.

Table of contents

1	General Description	7
1.1	Features.....	7
2	Safety and operational considerations	8
2.1	Warnings and notes	8
2.2	Battery and charging of Li-ion battery pack.....	10
2.2.1	Precharge	11
2.2.2	Li – ion battery pack guidelines.....	13
2.3	Standards applied.....	14
3	Terms and definitions	15
4	Instrument description	16
4.1	Instrument casing	16
4.2	Operator’s panel	16
5	Accessories	18
5.1	Standard set	18
5.2	Optional accessories.....	18
6	Instrument operation	19
6.1	General meaning of keys	19
6.2	General meaning of touch gestures.....	19
6.3	Virtual keyboard.....	20
6.4	Display and sound	21
6.4.1	Battery and time indication.....	21
6.4.2	Messages	21
6.4.3	Sound indication	23
6.4.4	Help screens	24
7	Main menu	25
7.1	Instruments main menu	25
8	General Settings.....	26
8.1	Language.....	27
8.2	Power Save	27
8.3	Date and time	28
8.4	Instrument profiles	28
8.5	Settings.....	29
8.6	Initial Settings	30
8.7	About	30
8.8	Auto Test Groups.....	31
8.8.1	Auto test groups menu	31
8.8.2	Operations in Auto test groups menu:.....	31
8.8.3	Selecting a list of Auto tests	32
8.8.4	Deleting a list of Auto tests	32
8.9	Workspace manager.....	33
8.9.1	Workspaces and Exports.....	33
8.9.2	Workspace Manager main menu	33
8.9.3	Operations with Workspaces.....	34
8.9.4	Operations with Exports	34
8.9.5	Adding a new Workspace	35

8.9.6	Opening a Workspace	36
8.9.7	Deleting a Workspace / Export	36
8.9.8	Importing a Workspace	37
8.9.9	Exporting a Workspace	37
9	Memory Organizer.....	39
9.1	Memory Organizer menu	39
9.1.1	Measurement statuses.....	39
9.1.2	Structure items.....	40
9.1.3	Measurement status indication under the Structure item	40
9.1.4	Operations in Tree menu	41
10	Single tests.....	53
10.1	Selection modes	53
10.1.1	Single test screens	54
10.1.2	Setting parameters and limits of single tests	55
10.1.3	Single test result screen.....	56
10.1.4	Graph view	57
10.1.5	Recall single test result screen	58
11	Tests and Measurements	59
11.1	Earth Measurements [Ze and Re].....	59
11.1.1	2 – pole Measurement.....	60
11.1.2	3 – pole Measurement.....	62
11.1.3	4 – pole Measurement.....	64
11.1.4	Selective (Iron Clamp) Measurement	66
11.1.5	2 Clamps Measurement	68
11.1.6	HF-Earth Resistance (25 kHz) Measurement	70
11.1.7	Selective (Flex Clamps 1 - 4) Measurement.....	72
11.1.8	Passive (Flex Clamps) Measurement.....	74
11.2	Specific Earth Resistance Measurements [ρ]	76
11.2.1	General on specific earth	76
11.2.2	Wenner method Measurement	77
11.2.3	Schlumberger method Measurement.....	79
11.3	Impulse Impedance [Z_p]	81
11.3.1	Impulse Measurement	81
11.4	DC Resistance [R]	83
11.4.1	Ω - Meter (200 mA) Measurement.....	83
11.4.2	Ω - Meter (7 mA) Measurement	84
11.5	AC Impedance [Z].....	86
11.5.1	Impedance Meter Measurement	86
11.6	Earth Potential [V_p].....	88
11.6.1	Potential Measurement	89
11.6.2	Step and Touch Voltages Theory	91
11.7	Pylon Ground Wire Test (PGWT)	93
11.7.1	PGWT Measurement	93
11.8	Current [I].....	95
11.8.1	Iron Clamp Meter RMS Measurement.....	96
11.8.2	Flex Clamp Meter RMS Measurement.....	97
11.9	Checkbox.....	98
11.9.1	Check V - Meter Measurement	99

11.9.2	Check A - Meter Measurement	100
11.9.3	Check Iron, Flex Clamps Measurement	101
12	Auto Tests.....	102
12.1	Selection of Auto tests	102
12.2	Organization of Auto tests.....	103
12.2.1	Auto test view menu	103
12.2.2	Step by step executions of Auto tests	105
12.2.3	Auto test result screen.....	106
12.2.4	Auto test memory screen	108
13	Communication	109
14	Maintenance	110
14.1	Cleaning.....	110
14.2	Periodic calibration	110
14.3	Service.....	110
14.4	Upgrading the instrument.....	110
15	Technical specifications.....	111
15.1	Earth [Ze].....	111
15.1.1	2, 3, 4 - pole	111
15.1.2	Selective (Iron Clamp)	112
15.1.3	2 Clamps	113
15.1.4	Passive (Flex Clamps 1-4)	113
15.1.5	HF Earth Resistance (25 kHz)	114
15.1.6	Selective (Flex Clamps 1 - 4)	115
15.2	Specific Earth Resistance Measurements [ρ]	116
15.2.1	Wenner and Schlumberger method	116
15.3	Earth Potential [Vp].....	117
15.3.1	Potential ratio	117
15.3.2	S&T Current Source	117
15.4	Impulse Impedance [Zp]	118
15.4.1	Impulse Measurement	118
15.5	DC Resistance [R]	119
15.5.1	Ω - Meter (200mA)	119
15.5.2	Ω - Meter (7mA)	120
15.6	AC Impedance [Z].....	121
15.6.1	Impedance Meter	121
15.7	Current [I].....	121
15.7.1	Iron Clamp Meter RMS	121
15.7.2	Flex Clamps Meter RMS.....	122
15.8	Influence of the auxiliary electrodes.....	123
15.9	Influence of low test current through clamps.....	124
15.10	Influence of noise.....	125
15.11	Sub-results in measurement functions.....	126
15.12	General data	127
Appendix A	– Structure objects.....	128
Appendix B	– Profiles Selection Table.....	129
Appendix C	– Functionality and placing of test probes	130

Appendix D – Pulse and 3-pole example 134
Appendix E - Programming of Auto tests on Metrel ES Manager 135

1 General Description

1.1 Features

Earth Analyser (MI 3290) is a Multi-function, portable battery (Li-ion) or mains powered test instrument with excellent IP protection: **IP65** (case closed), **IP54** (case opened), intended for diagnosing of: Earth Resistance, Earth Impedance, Selective Earth Impedance, Specific Earth Resistance, Earth Potential, DC Resistance, AC Impedance and Impulse Impedance.

It is designed and produced with the extensive knowledge and experience acquired through many years of working in this field.

Available functions and features offered by the **Earth Analyser**:

- Earth Impedance or Resistance 2, 3, 4 – pole;
- Selective Earth Impedance (Iron Clamp and up to 4 Flex Clamps);
- 2 Clamps Measurement;
- HF - Earth Resistance (25 kHz);
- Passive (Flex Clamps 1 - 4) method;
- Specific Earth Resistance ρ (Wenner, Schlumberger method);
- Ω - Meter (7 mA and 200 mA);
- AC Impedance Meter (55 Hz – 15 kHz);
- Impulse Impedance (10/350 μ s);
- Earth Potential and Step & Touch Current Source (200 mA);
- Pylon Ground Wire Test;
- Current RMS Measurement (Iron and Flex Clamps);
- Checkbox;
- Auto Tests;
- Memory Organizer.

A **4.3" (10.9 cm) colour LCD** display with **touch screen** offers easy-to-read results and all associated parameters. The operation is straightforward and clear to enable the user to operate the instrument without the need for special training (except reading and understanding this Instruction Manual).

Test results can be stored on the instrument. PC software that is supplied as a part of standard set enables transfer of measured results to PC where can be analysed or printed.

MI 3290 Earth Analyser	according to
2 – pole 3 – pole 4 – pole	EN 61557 – 5 [<i>Resistance to earth</i>] IEEE Std 81 – 2012 [<i>Two-point method, Three-point method, Fall-of-potential method</i>]
2 Clamps	IEEE Std 81 – 2012 [<i>Resistance measurements by clamp-on stakeless method</i>]
Selective (Flex Clamps 1 – 4) Selective (Iron Clamp)	IEEE Std 81 – 2012 [<i>Resistance measurements by FOP/clamp-on method</i>]
HF Earth Resistance (25 kHz)	IEEE Std 81 – 1983 [<i>High-Frequency Earth Resistance Meter</i>]
Wenner Method	IEEE Std 81 – 2012 [<i>Four-point method (Equally Spaced or Wenner Arrangement)</i>]
Schlumberger Method	IEEE Std 81 – 2012 [<i>Four-point method (Unequally Spaced or Schlumberger-Palmer Arrangement)</i>]
Ω - Meter (200mA)	EN 61557 – 4 [<i>Resistance of earth connection and equipotential bonding</i>]

2 Safety and operational considerations

2.1 Warnings and notes

In order to maintain the highest level of operator safety while carrying out various tests and measurements Metrel recommends keeping your **Earth Analyser** instruments in good condition and undamaged. When using the instrument, consider the following general warnings:

- The  symbol on the test equipment means »Read the Instruction manual with special care for safe operation«. The symbol requires an action!
- If the test equipment is used in a manner not specified in this Instruction manual, the protection provided by the equipment could be impaired!
- Read this Instruction manual carefully, otherwise the use of the test equipment may be dangerous for the operator, the test equipment itself or for the tested object!
- A lethal voltage can exist between the ground electrode under test and a remote ground!
- Do not use the test equipment or any of the accessories if any damage is noticed!
- Consider all generally known precautions in order to avoid risk of electric shock while dealing with hazardous voltages!
- Do not connect the test equipment to a mains voltage different from the one defined on the label adjacent to the mains connector, otherwise it may be damaged.
- Service intervention or adjustment is only allowed to be carried out by competent authorized personnel!
- All normal safety precautions must be taken in order to avoid risk of electric shock while working on electrical installations!
- Do not use the equipment in a wet environment, around explosive gas, vapour.
- Only adequately trained and competent persons may operate the equipment.
- Do not connect any voltage source on CLAMP input terminals. It is intended only for connection of current clamps. Maximal input voltage is 3 V!

Markings on the instrument:



Read the Instruction manual with special care to safety operation«. The symbol requires an action!



Mark on your equipment certifies that it meets European Union requirements for EMC, LVD, and ROHS regulations.



This equipment should be recycled as electronic waste.

**Warnings related to measurement functions:****Working with the instrument**

- ❑ Use only standard or optional test accessories supplied by your distributor!
- ❑ Always connect accessories to the test equipment and to the test object before starting measurement. Do not touch test leads or crocodile clips during measurement.
- ❑ Do not touch any conductive parts of equipment under test during the test, risk of electric shock!
- ❑ Make sure that the tested object is disconnected (mains voltage disconnected) and de-energized, before connecting the test leads and starting the measurement!
- ❑ Do not connect test terminals (H, S, ES, E) to an external voltage higher than 300 V DC or AC (CAT IV environment) to prevent any damage to the test equipment!
- ❑ Do not use a current measurement as an indication that a circuit is safe to touch. A voltage measurement is necessary to know if a circuit is hazardous.

**Warnings related to Batteries:**

- ❑ **Use only batteries provided by the manufacturer.**
- ❑ **Never dispose of the batteries in a fire as it may cause them to explode or generate a toxic gas.**
- ❑ **Do not attempt to disassemble, crush or puncture the batteries in any way.**
- ❑ **Do not short circuit or reverse polarity the external contacts on a battery.**
- ❑ **Keep the battery away from children.**
- ❑ **Avoid exposing the battery to excessive shock/impacts or vibration.**
- ❑ **Do not use a damaged battery.**
- ❑ **The Li – ion battery contains safety and protection circuit, which if damaged, may cause the battery to generate heat, rupture or ignite.**
- ❑ **Do not leave a battery on prolonged charge when not in use.**
- ❑ **If a battery has leaking fluids, do not touch any fluids.**
- ❑ **In case of eye contact with fluid, do not rub eyes. Immediately flush eyes thoroughly with water for at least 15 minutes, lifting upper and lower lids, until no evidence of the fluid remains. Seek medical attention.**

2.2 Battery and charging of Li-ion battery pack

The instrument is designed to be powered by rechargeable Li-ion battery pack or with mains supply. The LCD contains an indication of battery condition and the power source (upper left section of LCD). In case the battery is too weak the instrument indicates this as shown in **Figure 2.1**.

Symbol:

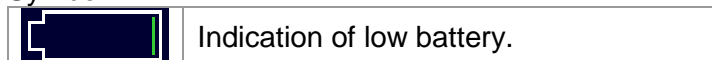

Figure 2.1: Battery test

The battery is charged whenever the power supply is connected to the instrument. The power supply socket is shown in Figure 2.2. Internal circuit controls (CC, CV) charging and assures maximum battery lifetime. Nominal operating time is declared for battery with nominal capacity of 4.4 Ah.



Figure 2.2: Power supply socket (C7)

The instrument automatically recognizes the connected power supply and begins charging.

Symbol:

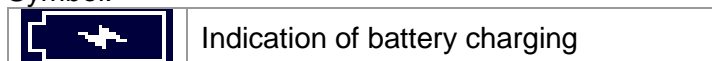

Figure 2.3: Charging indication (animation)

Battery and charging characteristic	Typical
Battery type	VB 18650
Charging mode	CC / CV
Nominal voltage	14,8 V
Rated capacity	4,4 Ah
Max charging voltage	16,7 V
Max charging current	1,2 A
Max discharge current	2,5 A
Typical charging time	4 hours

Typical charging profile which is also used in this instrument is shown in **Figure 2.4**.

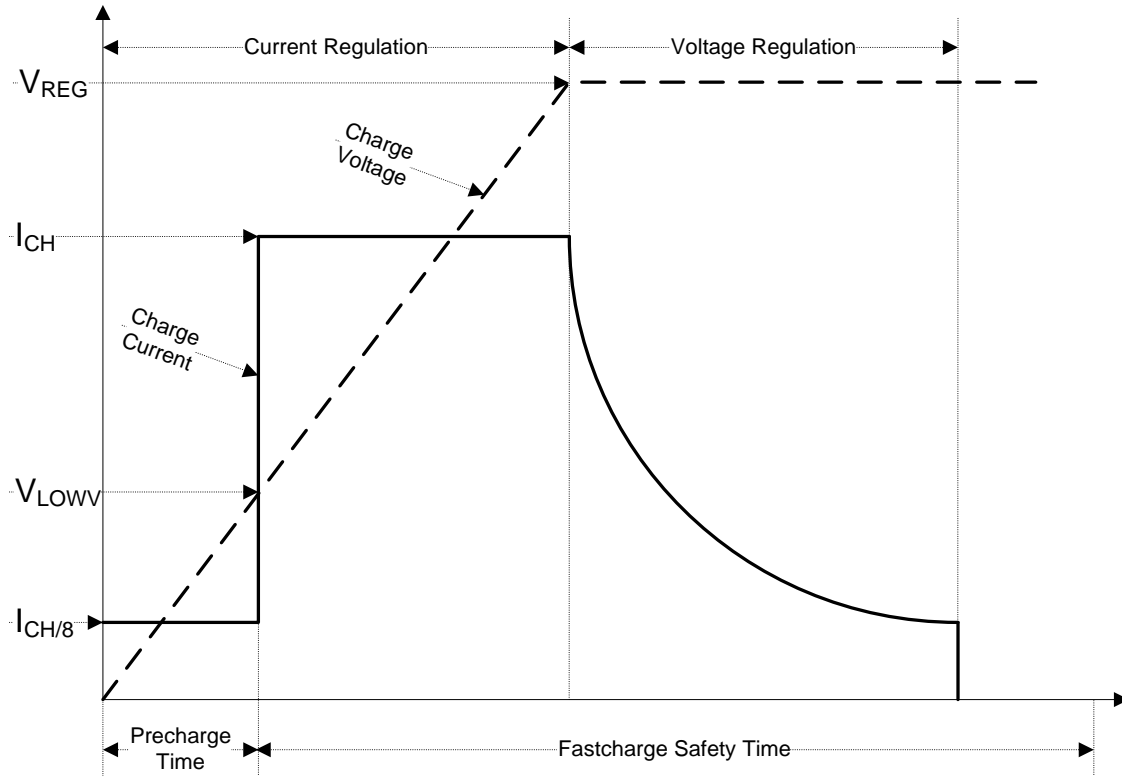

Figure 2.4: Typical charging profile

where:

- V_{REG} Battery charging voltage
- V_{LOWV} Precharge threshold voltage
- I_{CH} Battery charging current
- $I_{CH/8}$ 1/8 of the charging current

2.2.1 Precharge

On power up, if the battery voltage is below the V_{LOWV} threshold, the charger applies 1/8 of the charging current to the battery. The precharge feature is intended to revive deeply discharged battery. If the V_{LOWV} threshold is not reached within 30 minutes of initiating precharge, the charger turns off and a **FAULT** is indicated.



Figure 2.5: Battery fault indication (charging suspended, timer fault, battery absent)



Figure 2.6: Battery full indication (charging completed)

Note:

- As a safety backup, the charger also provides an internal 5-hour charge timer for fast charge.

Typical charging time is 4 hours in the temperature range of 5°C to 60°C.

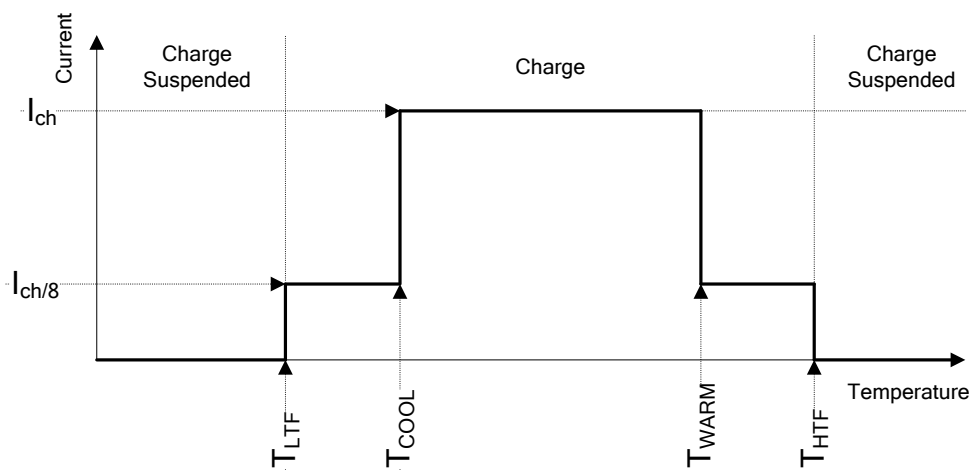

Figure 2.7: Typical charging current vs temperature profile

where:

- T_{LTF} Cold temperature threshold (typ. -15°C)
- T_{COOL} Cool temperature threshold (typ. 0°C)
- T_{WARM} Warm temperature threshold (typ. +60°C)
- T_{HTF} Hot temperature threshold (typ. +75°C)

The charger continuously monitors battery temperature. To initiate a charge cycle, the battery temperature must be within the T_{LTF} to T_{HTF} thresholds. If battery temperature is outside of this range, the controller suspends charge and waits until the battery temperature is within the T_{LTF} to T_{HTF} range.

If the battery temperature is between the T_{LTF} and T_{COOL} thresholds or between the T_{WARM} and T_{HTW} thresholds, charge is automatically reduced to I_{CH/8} (1/8 of the charging current).

2.2.2 Li – ion battery pack guidelines

Li – ion rechargeable battery pack requires routine maintenance and care in their use and handling. Read and follow the guidelines in this Instruction manual to safely use Li – ion battery pack and achieve the maximum battery life cycles.

Do not leave batteries unused for extended periods of time – more than 6 months (self – discharge).

When a battery has been unused for 6 months, check the charge status see chapter 6.4.1 **Battery and time indication**. Rechargeable Li – ion battery pack has a limited life and will gradually lose their capacity to hold a charge. As the battery loses capacity, the length of time it will power the product decreases.

Storage:

- ❑ Charge or discharge the instruments battery pack to approximately 50% of capacity before storage.
- ❑ Charge the instrument battery pack to approximately 50% of capacity at least once every 6 months.

Transportation:

- ❑ Always check all applicable local, national, and international regulations before transporting a Li – ion battery pack.



Handling Warnings:

- ❑ **Do not disassemble, crush, or puncture a battery in any way.**
- ❑ **Do not short circuit or reverse polarity the external contacts on a battery.**
- ❑ **Do not dispose of a battery in fire or water.**
- ❑ **Keep the battery away from children.**
- ❑ **Avoid exposing the battery to excessive shock/impacts or vibration.**
- ❑ **Do not use a damaged battery.**
- ❑ **The Li – ion battery contains safety and protection circuit, which if damaged, may cause the battery to generate heat, rupture or ignite.**
- ❑ **Do not leave a battery on prolonged charge when not in use.**
- ❑ **If a battery has leaking fluids, do not touch any fluids.**
- ❑ **In case of eye contact with fluid, do not rub eyes. Immediately flush eyes thoroughly with water for at least 15 minutes, lifting upper and lower lids, until no evidence of the fluid remains. Seek medical attention.**

2.3 Standards applied

The Earth Analyser instrument is manufactured and tested in accordance with the following regulations:

Electromagnetic compatibility (EMC)

EN 61326 Electrical equipment for measurement, control and laboratory use – EMC requirements Class A

Safety (LVD)

EN 61010 - 1 Safety requirements for electrical equipment for measurement, control and laboratory use – Part 1: General requirements

EN 61010 - 2 - 030 Safety requirements for electrical equipment for measurement, control and laboratory use – Part 2-030: Particular requirements for testing and measuring circuits

EN 61010 - 2 - 032 Safety requirements for electrical equipment for measurement, control and laboratory use – Part 2-032: Particular requirements for hand-held and hand-manipulated current sensors for electrical test and measurement.

EN 61010 - 031 Safety requirements for hand-held probe assemblies for electrical measurement and test.

Some further recommendations

EN 61557 - 5 Electrical safety in low voltage distribution systems up to 1000 V a.c. and 1500 V d.c. - Equipment for testing, measuring or monitoring of protective measures. Part 5: Resistance to earth.

IEEE 80 – 2000 IEEE Guide for Safety in AC Substation Grounding

IEEE 81 – 2012 IEEE Guide for Measuring Earth Resistivity, Ground Impedance, and Earth Surface Potentials of a Grounding System.

IEEE 142 IEEE Recommended Practice for Grounding of Industrial and Commercial Power Systems (US).

IEEE 367 – 2012 IEEE Recommended Practice for Determining the Electric Power Station Ground Potential Rise and Induced Voltage from a Power Fault.

Li – ion battery pack

IEC 62133 Secondary cells and batteries containing alkaline or other non-acid electrolytes - Safety requirements for portable sealed secondary cells, and for batteries made from them, for use in portable applications.

Note about EN and IEC standards:

- Text of this manual contains references to European standards. All standards of EN 6XXXX (e.g. EN 61010) series are equivalent to IEC standards with the same number (e.g. IEC 61010) and differ only in amended parts required by European harmonization procedure.

3 Terms and definitions

For the purposes of this document and instrument Earth Analyser, the following definitions apply.

Index:	Unit:	Description:
Re	[Ω]	Earth resistance of complete system.
Ze	[Ω]	Earth impedance of complete system.
Rp	[Ω]	Auxiliary potential probe impedance.
Rc	[Ω]	Auxiliary current probe impedance.
le	[A]	System current or generator current.
f	[Hz]	Test frequency.
lc	[A]	Iron clamp current.
Zsel	[Ω]	Earth impedance of measured branch.
Ztot	[Ω]	Total earth impedance of measured branches.
If1	[A]	Flex clamp 1 current [F1 – terminal].
If2	[A]	Flex clamp 2 current [F2 – terminal].
If3	[A]	Flex clamp 3 current [F3 – terminal].
If4	[A]	Flex clamp 4 current [F4 – terminal].
Zsel1	[Ω]	Earth impedance of measured branch [F1 – terminal].
Zsel2	[Ω]	Earth impedance of measured branch [F2 – terminal].
Zsel3	[Ω]	Earth impedance of measured branch [F3 – terminal].
Zsel4	[Ω]	Earth impedance of measured branch [F4 – terminal].
ρ	[Ω m/ft]	Specific earth resistance [resistivity].
R	[Ω]	Resistance [DC current].
Idc	[A]	DC current.
Z	[Ω]	Impedance [AC current].
Iac	[A]	AC current.
Vp	[]	Potential ratio [is defined as the inverted value of Us voltage divided by Uh voltage].
R	[m]	Total distance between E and auxiliary earth rod H.
r	[m]	Distance between E and S probe.
φ	[°]	Direction of potential measurement or angle [0° - 360°].
Igen	[A]	Generator current.
If_sum	[A]	Flex clamp current [If_sum = If1 + If2 + If3 + If4].
Uh	[V]	Uh voltage [H – terminal].
Us	[V]	Us voltage [S – terminal].
Ues	[V]	Ues voltage [ES – terminal].
Ig_w	[A]	Overhead ground wire current [Ig_w = Igen - If_sum].
R	[Ω]	Complex number [real number].
X	[Ω]	Complex number [Imaginary number].
φ	[°]	Phase angle between u and i.
Zp	[Ω]	Impulse impedance [is defined as the peak voltage divided by the peak current].
Up	[V]	Peak voltage.
Ip	[A]	Peak current.

Designation of the terminals:

- E** - terminal for the earth electrode;
- ES** - terminal for the probe placed nearest to the earth electrode;
- S** - terminal for a probe;
- H** - terminal for the auxiliary earth electrode.

Notes (acc.to IEEE Std 81 - 2012):

- Earth Resistance** – The impedance, excluding reactance, between a ground electrode, grid or system and remote earth.
- Earth Impedance** – The vector sum of resistance and reactance between a ground electrode, grid or system and remote earth.

4 Instrument description

4.1 Instrument casing

The instrument is housed in a plastic box that maintains the protection class defined in the general specifications.

4.2 Operator's panel

The operator's panel is shown in Figure 4.1 below.

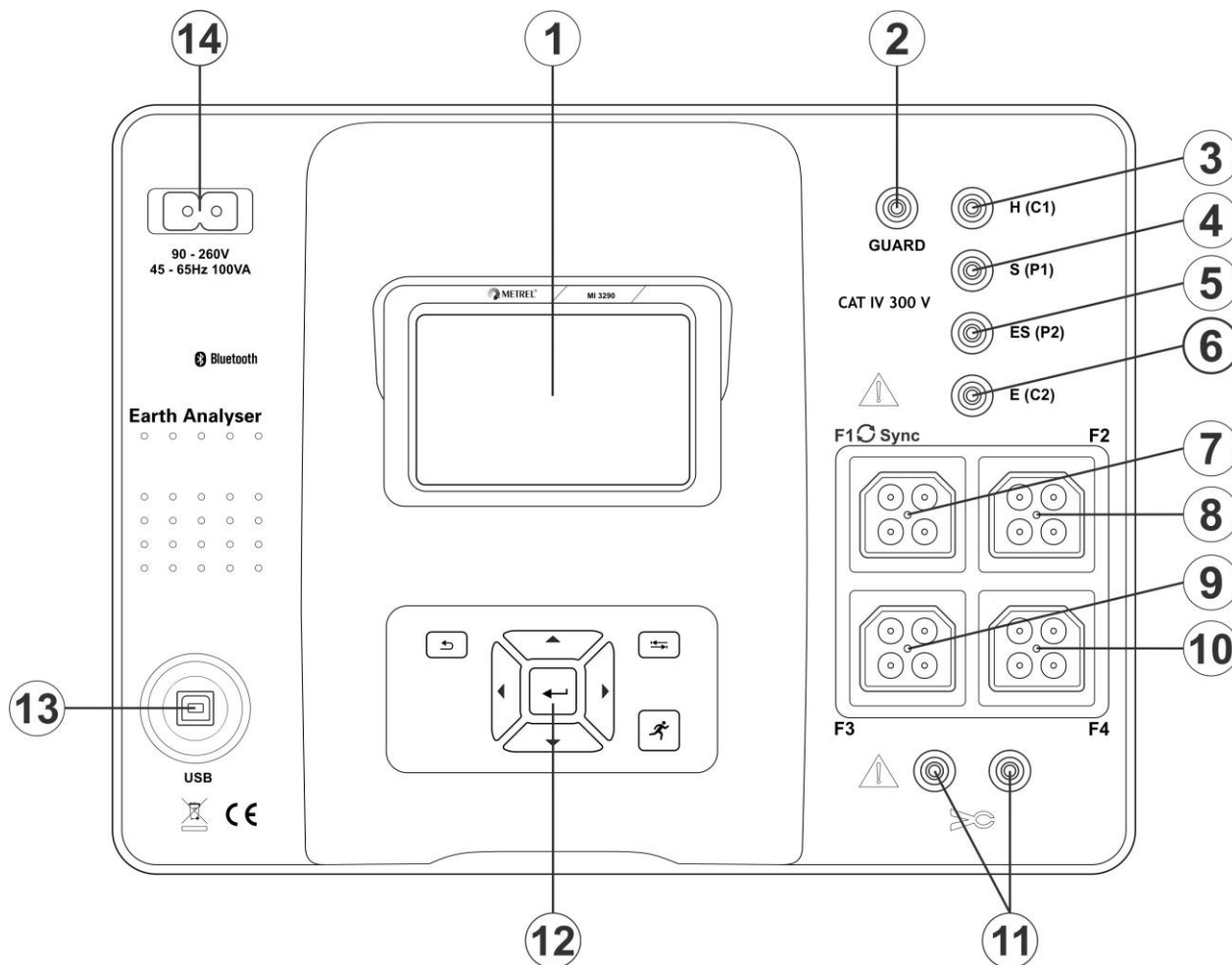

Figure 4.1: The operator's panel

1		Colour TFT display with touch screen
2	GUARD	Guard input terminal
3	H (C1)	Output terminal for the auxiliary earth electrode
4	S (P1)	Output terminal for a probe
5	ES (P2)	Output terminal for the probe placed nearest to the earth electrode
6	E (C2)	Output terminal for the earth/ground electrode to be measured
7	F1 (Sync)	Flex clamp 1 input terminal (Synchronization port)
8	F2	Flex clamp 2 input terminal
9	F3	Flex clamp 3 input terminal

10	F4	Flex clamp 4 input terminal
11	CLAMP	Iron clamp input terminal
12		Keypad (see section 6.1 General meaning of keys)
13	USB	USB communication port (standard USB connector - type B)
14		Input power supply socket (type C7)







Warnings!

- ❑ **Do not connect test terminals (H, S, ES, E) to an external voltage higher than 300 V DC or AC (CAT IV environment) to prevent any damage to the test equipment!**
- ❑ **Do not connect any voltage source on CLAMP input terminals. It is intended only for connection of current clamps. Maximal input voltage is 3 V!**
- ❑ **Use original test accessories only!**

5 Accessories

The accessories consist of standard and optional accessories. Optional accessories can be delivered upon request. See *attached* list for standard configuration and options or contact your distributor or see the METREL home page: <http://www.metrel.si>.

MI 3290 Earth Analyser is available in multiple sets with a combination of different accessories and measurement functions. The functionality of an existing set can be expanded by ordering additional accessory and license keys.

Measurement functions available	Profile Code Name	ARAB MI 3290 GF	ARAA MI 3290 GL	ARAC MI 3290 GP	ARAD MI 3290 GX
	Icon				  
2, 3, 4 - pole		•	•	•	•
Selective (Iron Clamp)			•		•
2 Clamps			•		•
HF-Earth Resistance (25 kHz)			•		•
Selective and Passive (Flex Clamps 1 - 4)				•	•
Wenner and Schlumberger method		•	•	•	•
Impulse Measurement			•		•
Ω - Meter (200 mA and 7 mA)		•			•
Impedance Meter		•			•
Potential and S&T Current Source		•			•
Pylon Ground Wire Test				•	•
Iron Clamp Meter RMS			•		•
Flex Clamp Meter RMS				•	•

5.1 Standard set

- Instrument MI 3290 Earth Analyser
- Prof. earth test rod, 50 cm, 2 pcs
- Prof. earth test rod, 90 cm, 2 pcs
- Test lead 2 m, 1 pcs (black)
- Test lead 5 m, 2 pcs (red, blue)
- Test lead 50 m, 3 pcs reel (green, black, blue)
- Shielded test lead 75 m reel
- G clamp, 1 pcs
- Crocodile clips, 4 pcs (black, red, green, blue)
- Test probes, 4 pcs (black, red, green, blue)
- Test lead set (S 2009), 2m, 4 pcs (black, red, green, blue)
- Mains cable
- USB cable
- Bag for accessories
- PC SW Metrel ES Manager
- Instruction manual
- Calibration certificate

5.2 Optional accessories

See the attached sheet for a list of optional accessories and licence keys that are available on request from your distributor.

6 Instrument operation

The Earth Analyser instrument can be manipulated via a keypad or touch screen.

6.1 General meaning of keys



Cursor keys are used to:

- select appropriate option;
- decrease, increase the selected parameter.



Enter key is used to:

- confirm selected option.

Escape key is used to:

- return to previous menu without changes;
- abort measurement.

Second function:

- switches the instrument power on or off (hold key for 2 s for confirmation screen);
- instrument hard off (hold key for 10 s or more).

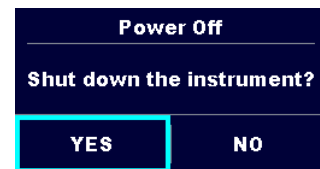

The instrument automatically turns off 10 minutes after the last key was pressed.



Tab key is used to:

- expand column in control panel.



Run key is used to:

- start and stop the measurements.

6.2 General meaning of touch gestures



Tap (briefly touch surface with fingertip) is used to:

- select appropriate option;
- confirm selected option;
- start and stop measurements.



Swipe (press, move, lift) up/ down is used to:

- scroll content in same level;
- navigate between views in same level.



long

Long press (touch surface with fingertip for at least 1 s) is used to:

- select additional keys (virtual keyboard);
- select test or measurement using cross selector.











Tap Escape icon is used to:

- return to previous menu without changes;
- abort measurements.

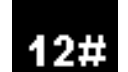
6.3 Virtual keyboard



Figure 6.1: Virtual keyboard

	Toggle case between lowercase and uppercase. Active only when alphabetic characters' keyboard layout selected.
	Backspace Clears last character or all characters if selected (If held for 2 s, all characters are selected).
	Enter confirms new text.
	Activates numeric / symbols layout.
	Activates alphabetic characters.
	English keyboard layout.
	Greek keyboard layout.
	Russian keyboard layout.
	Returns to the previous menu without changes.

6.4 Display and sound

6.4.1 Battery and time indication

The battery indication indicates the charge condition of battery and connection of external charger.



Battery capacity indication.



Low battery. Recharge the battery cells.



Battery is full.



Battery fault indication.



Charging in progress (if power supply adapter is connected and battery inserted).

08:26

Time indication (hh:mm).

6.4.2 Messages

In the message field warnings and messages are displayed.



Conditions on the input terminals allow starting the measurement; consider other displayed warnings and messages.



Conditions on the input terminals do not allow starting the measurement, consider displayed warnings and messages.



Stop the measurement.



Result(s) can be stored.



Opens menu for changing parameters and limits.



Previous screen view.



Next screen view.



Previous screen result.



Next screen result.



Edit chart (zoom in or zoom out, and move cursor).



Opens help screen.



Views results of measurement.



Starts test leads compensation in Ω - Meter (200 mA and 7 mA) measurement.



Expands control panel / open more options.



Warning! High voltage is applied to the test terminals. Measurement will not be started. *Limit [> 50 Vrms H-E, S-E, ES-E, H-Guard, S-Guard, ES-Guard].*



The measuring range of the instrument is exceeded. Measurement will not be started or displayed!



High electrical noise was detected during measurement. Results may be impaired. *Limit [Noise frequency is close (± 6 %) to the test frequency].*



Measurement is running, consider displayed warnings.



High impedance to earth of test probes.
See chapter **15.8 Influence of the auxiliary electrodes.**



High impedance of current probe Rc.
See chapter **15.8 Influence of the auxiliary electrodes.**



High impedance of current probe Rp.
See chapter **15.8 Influence of the auxiliary electrodes.**



Test leads resistance in Ω - Meter (200 mA and 7 mA) measurement is not compensated. *Limit [Lead compensation < 5 Ω].*



Test leads resistance in Ω - Meter (200 mA and 7 mA) measurement is compensated.



Low test current through Iron or Flex clamps. Results may be impaired.
See chapter **15.9 Influence of low test current through clamps.**



Negative current through flex clamps, check the right direction of the Flex clamps [$\uparrow \downarrow$].



H(C1), S(P1), ES(P2) or E(C2) terminal is not connected to the instrument or too high resistance is detected. *Limit [Igen > 100 μ A].*



F1 - Flex clamp 1 input terminal (Synchronization port) is not connected to the instrument. Always connect flex clamp to F1 terminal first.

Limit

With the low limit the user is allowed to set the limit resistance, current or voltage value. Measured resistance, current or voltage is compared against the limit. Result is validated only if it is within the given limit. Limit indication is shown in the test parameter window.

Message window:



Measurement result is inside pre-set limits (PASS).



Measurement result is out of pre-set limits (FAIL).



Measurement is aborted. Consider displayed warnings and messages.

Note:

- **Pass / Fail indication is only displayed if limit is set.**

6.4.3 Sound indication

Two beeps
sound

PASS! Means that the measuring result data lies inside expected limits.

One long
beep sound

FAIL! Means that the measuring result data is out of predefined limits.

Continuous
sound

Warning! High voltage is applied to the test terminals. Measurement will not be started. *Limit [> 50 Vrms H-E, S-E, ES-E, H-Guard, S-Guard, ES-Guard].*
Measured value in Ω - Meter (7 mA) measurement is below set limit.

6.4.4 Help screens



Opens help screen.

Help menus are available in all functions. The Help menu contains schematic diagrams for illustrating proper connection of the instrument to the test object. After selecting the measurement, you want to perform, press the HELP key in order to view the associated Help menu.

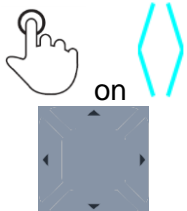

Selects next / previous help screen.



Exits help menu.

HELP 1/20: 2 Clamps 09:58

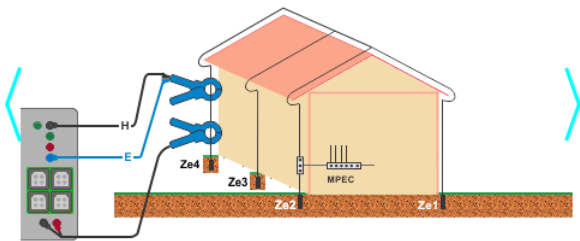

HELP 10/20: Passive Flex C. 09:58

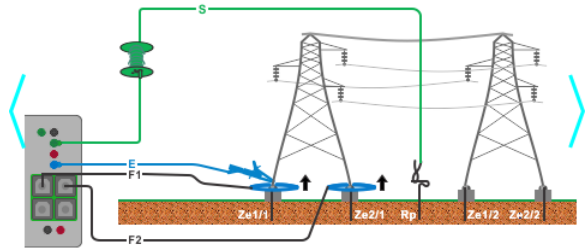

HELP 15/20: Wenner Method 09:58

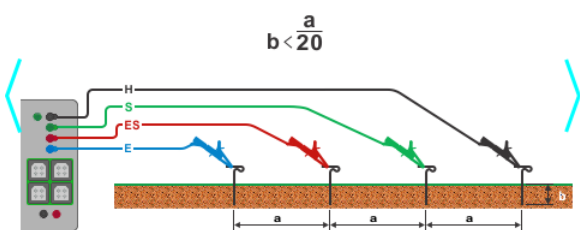

HELP 4/20: 4 - pole 09:58

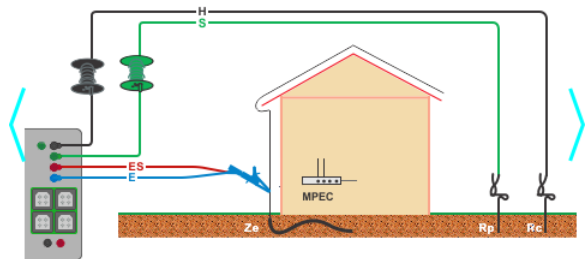

Figure 6.2: Examples of help screens

7 Main menu

7.1 Instruments main menu

From the Main menu different main operation menus can be selected.

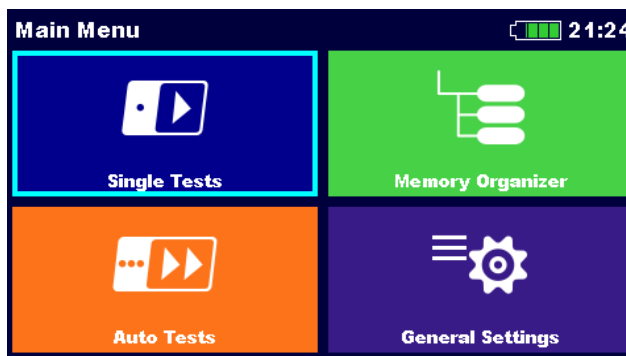

Figure 7.1: Main menu

Options in main menu:



Single Tests

Menu with single tests, see chapter **11 Tests and Measurements** for more information.



Auto Tests

Menu with customized test sequences, see chapter **12 Auto Tests** for more information.



Memory Organizer

Menu for working with and documentation of test data, see chapter **9 Memory Organizer** for more information.



General Settings

Menu for setup of the instrument, see chapter **8 General Settings** for more information.

8 General Settings

In the **General settings** menu general parameters and settings of the instrument can be viewed or set.

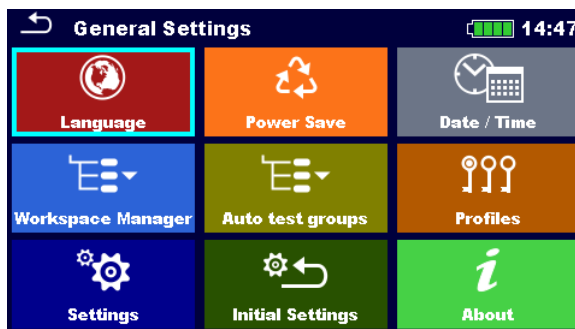

Figure 8.1: General settings menu

Options in General Settings menu:



Language

Instrument language selection. Refer to chapter **8.1 Language** for more information.



Power Save

Brightness of LCD, enabling/disabling Bluetooth communication. Refer to chapter **8.2 Power Save** for more information.



Date /Time

Instruments Date and time. Refer to chapter **8.3 Date and time** for more information.



Workspace Manager

Manipulation with project files. Refer to chapter **8.9 Workspace manager** for more information.



Auto Test Groups

Manipulation with lists of Auto tests. Refer to chapter **8.8 Auto Test Groups** for more information.



Instrument Profile

Selection of available instrument profiles. Refer to chapter **8.4 Instrument profiles** for more information.



Settings

Settings of different system / measuring parameters. Refer to chapter **8.5 Settings** for more information.



Initial Settings

Factory settings. Refer to chapter **8.6 Initial Settings** for more information.



About

Instrument info. Refer to chapter **8.7 About** for more information.

8.1 Language

In this menu the language of the instrument can be set.

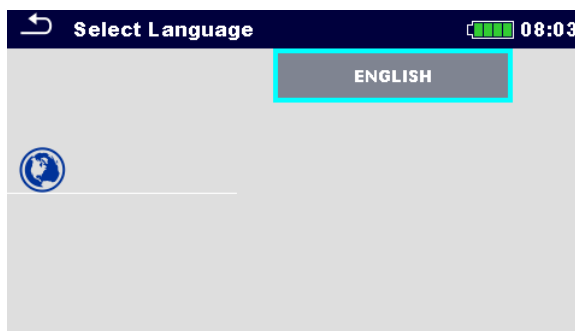

Figure 8.2: Language menu

8.2 Power Save

In this menu different options for decreasing power consumption can be set.

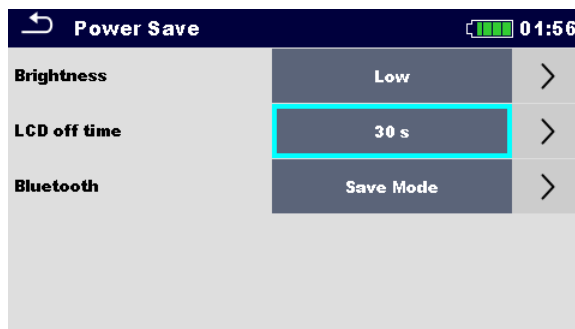

Figure 8.3: Power save menu

Brightness	Setting level of LCD brightness level.
LCD off time	Setting LCD off after set time interval. LCD is switched on after pressing any key or touching the LCD.
Bluetooth	Always On: Bluetooth module is ready to communicate. Save mode: Bluetooth module is set to sleep mode and is not functioning.

8.3 Date and time

In this menu the date and time of the instrument can be set.

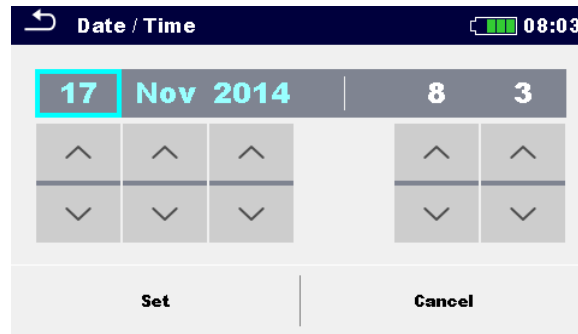

Figure 8.4: Setting date and time

8.4 Instrument profiles

In this menu the instrument profile can be selected from the available ones.

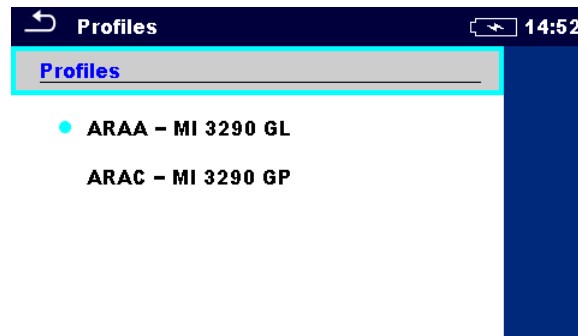

Figure 8.5: Instrument profiles menu

The instrument uses different specific system and measuring settings regarding to the scope of work or country it is used. These specific settings are stored in instrument profiles.

By default, each instrument has at least one profile activated. Proper licence keys must be obtained to add more profiles to the instruments.

If different profiles are available, they can be selected in this menu. For more information, refer to chapter **Appendix B – Profiles Selection Table**.

Options



Loads the selected profile. The instrument will restart automatically with new profile loaded.



Deletes the selected profile.

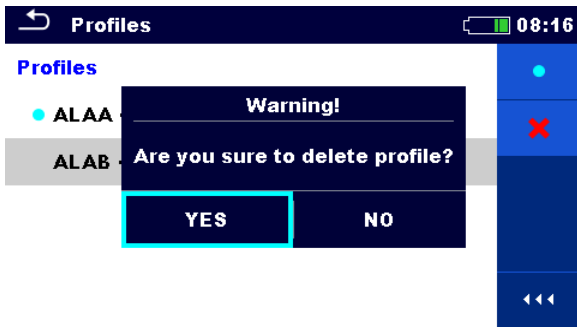

Before deleting the selected profile user is asked for confirmation.



Expands control panel / open more options.

8.5 Settings

In this menu different general parameters can be set.

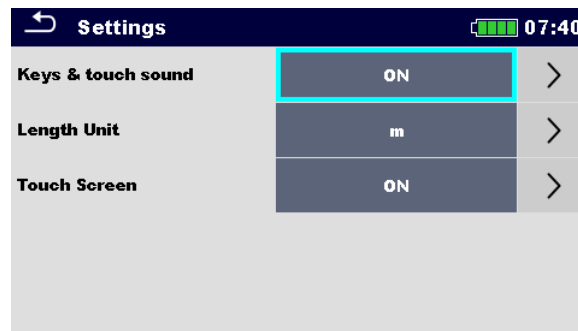

Figure 8.6: Settings menu

	Available selection	Description
Keys & touch sound	[ON, OFF]	Enables / disables sound when using keys and touch screen.
Length Unit	[m, ft]	Length unit for specific earth resistance measurement.
Touch screen	[ON, OFF]	Enables / disables operation with touch screen.

8.6 Initial Settings

In this menu the instrument settings, measurement parameters and limits can be set to initial (factory) values.

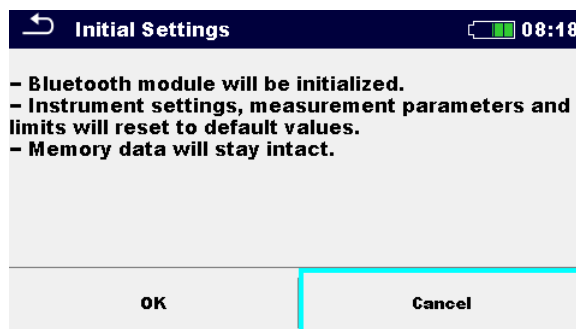

Figure 8.7: Initial settings menu

Warning:

Following customized settings will be lost when setting the instruments to initial settings:

- Measurement limits and parameters.
- Parameters and settings in General settings menu.
- Applying the initial settings will re-boot the instrument.

Notes:

Following customized settings will stay:

- Profile settings.
- Data in memory.

8.7 About

In this menu instrument data (name, version, serial number and date of calibration) can be viewed.

About	
Name	MI 3290 EarthAnalyzer
S/N	15440219
FW version	1.0.0
HW version	1.0
Date of calibration	09.Feb.2016
(C) Metrel d.d., 2015, http://www.metrel.si	

Figure 8.8: Instrument info screen

8.8 Auto Test Groups

The Auto tests in Earth Analyser can be organized in lists of Auto tests. In a list a group of similar Auto tests is stored. The Auto test groups menu is intended to manage with different lists of Auto tests that are stored on the microSD card.

8.8.1 Auto test groups menu

In Auto test groups menu lists of Auto tests are displayed. Only one list can be opened in the instrument at the same time. The list selected in the Auto test groups menu will be opened in the Auto Tests main menu.

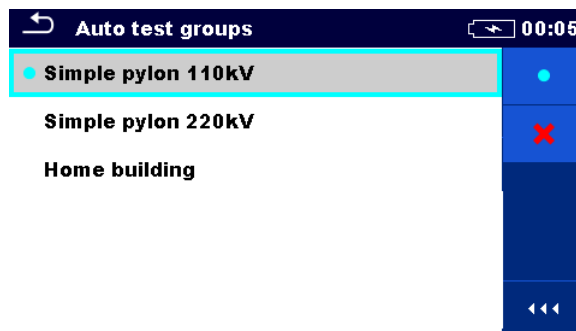

Figure 8.9: Auto test groups menu

8.8.2 Operations in Auto test groups menu:

Options



Opens the selected list of Auto tests. Previously selected list of Auto tests will be closed automatically.
Refer to chapter **8.8.3 Selecting a list of Auto tests** for more information.



Deletes the selected list of Auto tests.
Refer to chapter **8.8.4 Deleting a list of Auto tests** for more information.



Opens options in control panel / expands column.

8.8.3 Selecting a list of Auto tests

Procedure

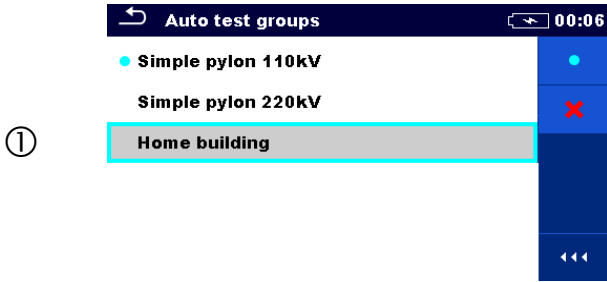

A list of Auto tests can be selected from the Auto test groups menu.



Enters option for selecting a list.

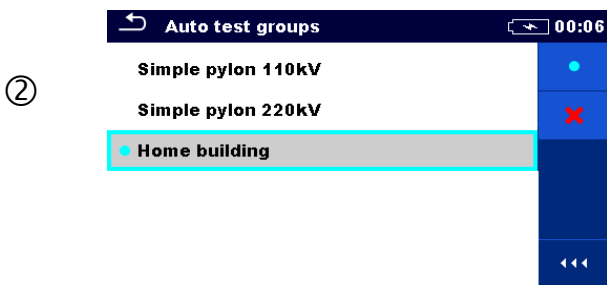

Selected list of Auto tests is marked with a blue dot.

Note:
Previously selected list of Auto tests is closed automatically.

8.8.4 Deleting a list of Auto tests

Procedure

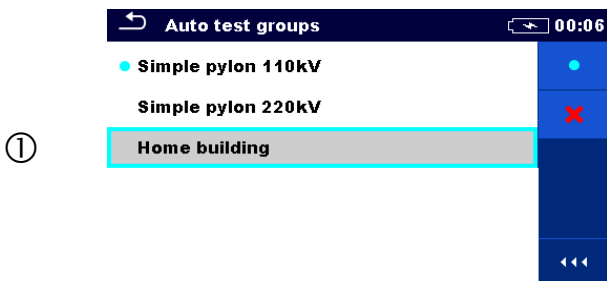

A list of Auto tests to be deleted can be selected from the Auto test groups menu.



Enters option for deleting a list.

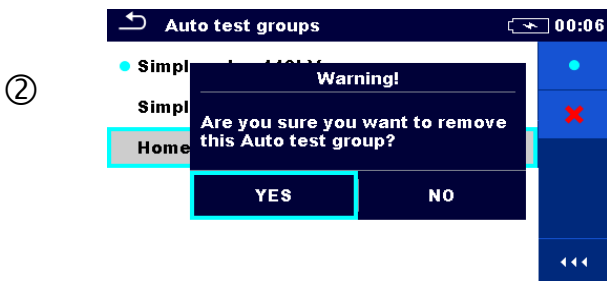

Before deleting the selected list of Auto tests the user is asked for confirmation.



8.9 Workspace manager

The Workspace Manager is intended to manage with different Workspaces and Exports that are stored into internal data memory.

8.9.1 Workspaces and Exports

The works with MI 3290 can be organized and structured with help of Workspaces and Exports. Exports and Workspaces contain all relevant data (measurements, parameters, limits, structure objects) of an individual work.

Workspaces are stored on internal data memory on directory WORKSPACES, while Exports are stored on directory EXPORTS. Export files can be read by Metrel applications that run on other devices. Exports are suitable for making backups of important works. To work on the instrument an Export should be imported first from the list of Exports and converted to a Workspace. To be stored as Export data a Workspace should be exported first from the list of Workspaces and converted to an Export.

8.9.2 Workspace Manager main menu

In Workspace manager Workspaces and Exports are displayed in two separated lists.

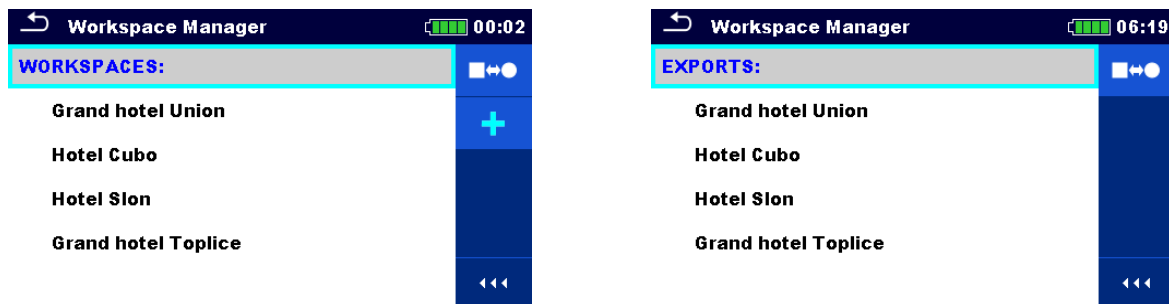

Figure 8.10: Workspace manager menu

Options

WORKSPACES:

List of Workspaces.



Displays a list of Exports.



Adds a new Workspace. Refer to chapter **8.9.5 Adding a new Workspace** for more information.

EXPORTS:

List of Exports.



Displays a list of Workspaces.

8.9.3 Operations with Workspaces

Only one Workspace can be opened in the instrument at the same time. The Workspace selected in the Workspace Manager will be opened in the Memory Organizer.

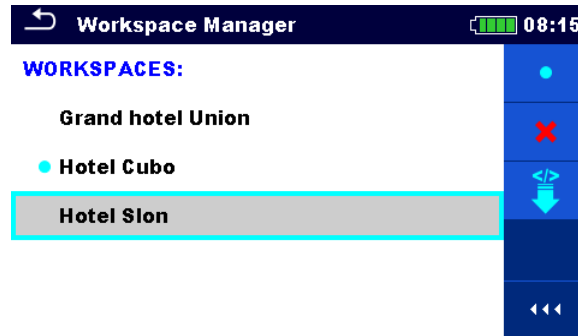

Figure 8.11: Workspaces menu

Options

- Marks the opened Workspace in Memory Organizer.
 Opens the selected Workspace in Memory Organizer.
 Refer to chapter **8.9.6 Opening a Workspace** for more information.
- X

Deletes the selected Workspace.
 Refer to chapter **8.9.7 Deleting a Workspace / Export** for more information.
- +

Adds a new Workspace.
 Refer to chapter **8.9.5 Adding a new Workspace** for more information.
- </>
↓

Exports a Workspace to an Export.
 Refer to **8.9.9 Exporting a Workspace** for more information.

8.9.4 Operations with Exports



Figure 8.12: Workspace manager Exports menu

Options

- X

Deletes the selected Export.
 Refer to chapter **8.9.7 Deleting a Workspace / Export** for more information.
- ↑
</>

Imports a new Workspace from Export.
 Refer to **8.9.8 Importing a Workspace** for more information.

8.9.5 Adding a new Workspace

Procedure

①



New Workspaces can be added from the Workspace Manager screen.



Enters option for adding a new Workspace.

②



Keypad for entering name of a new Workspace is displayed after selecting New.

③

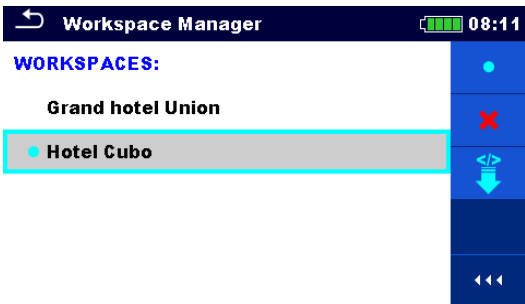

After confirmation a new Workspace is added in the list in Main Workspace Manager menu.

8.9.6 Opening a Workspace

Procedure



Workspace can be selected from a list in Workspace manager screen.



Opens a Workspace in Workspace manager.



The opened Workspace is marked with a blue dot. The previously opened Workspace will close automatically.

8.9.7 Deleting a Workspace / Export

Procedure



Workspace / Export to be deleted should be selected from the list of Workspaces / Exports. Opened workspace can't be deleted.



Enters option for deleting a Workspace / Export.

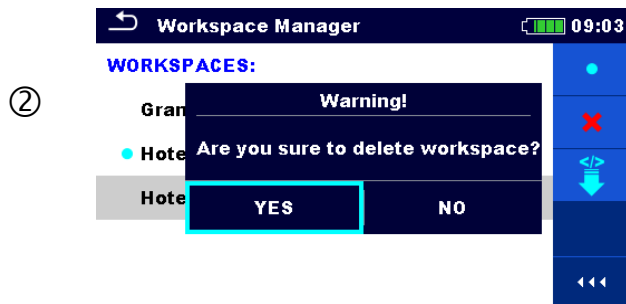

Before deleting the selected Workspace / Export the user is asked for confirmation.



Workspace / Export is removed from the Workspace / Export list.

8.9.8 Importing a Workspace



Select an Export file to be imported from Workspace Manager Export list.



Enters option Import.

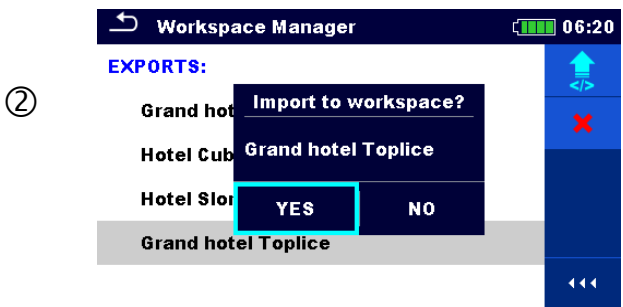

Before the import of the selected file the user is asked for confirmation.



The Imported Export file is added to the list of Workspaces.

Note:

- ❑ If a Workspace with the same name already exists the name of the imported Workspace will be changed (name_001, name_002, name_003...).

8.9.9 Exporting a Workspace



Select a Workspace from Workspace manager list to be exported to an Export file.



Enters option Export.

②

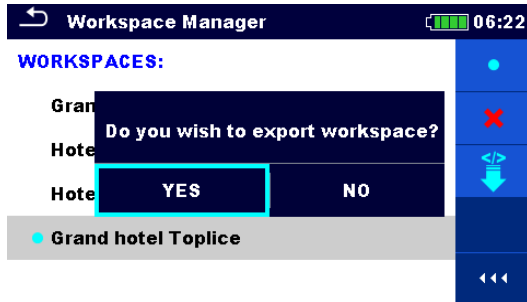

Before exporting the selected Workspace, the user is asked for confirmation.

③

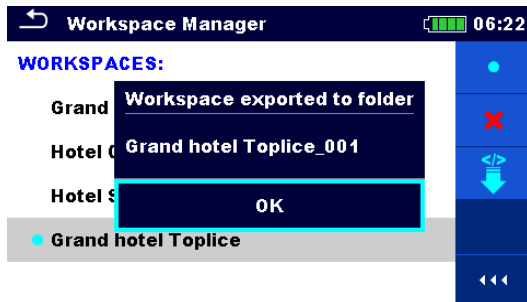

Workspace is exported to Export file and is added to the list of Exports.

Note:

- If an Export file with the same name already exists the name of the Export file will be changed (name_001, name_002, name_003, ...).



9 Memory Organizer

Memory Organizer is a tool for storing and working with test data.

9.1 Memory Organizer menu

Earth Analyser instrument has a multi-level structure. The hierarchy of Memory organizer in the tree is shown on **Figure 9.1**. The data is organized according to the project, object (building, power station, sub-station, transmission tower, ...) and device under test (lightning rod, grounding rod, transformer, mesh, fence, ...). For more information, refer to chapter **Appendix A – Structure objects**.

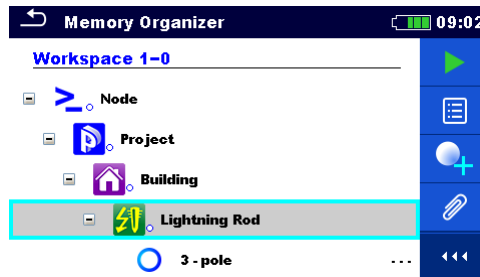

Figure 9.1: Default tree structure and its hierarchy

9.1.1 Measurement statuses

Each measurement has:

- a status (Pass or Fail or no status),
- a name,
- results,
- limits and parameters.

A measurement can be a Single test or an Auto test.

For more information, refer to chapters **10 Single tests** and **12 Auto Tests**.

Statuses of Single tests

- passed finished single test with test results
- failed finished single test with test results
- finished single test with test results and no status
- empty single test without test results

Overall statuses of Auto tests

- or ✓ at least one single test in the Auto test passed and no single test failed
- or ✗ at least one single test in the Auto test failed
- or - at least one single test in the Auto test was carried out and there were no other passed or failed single tests.

○ or



empty Auto test with empty single tests

9.1.2 Structure items

Each Structure item has:

- an icon
- a name and
- parameters.

Optionally they can have:

- an indication of the status of the measurements under the Structure and a comment or a file attached.



Figure 9.2: Structure project in tree menu

9.1.3 Measurement status indication under the Structure item

Overall status of measurements under each structure item /sub-item can be seen without spreading tree menu. This feature is useful for quick evaluation of test status and as guidance for measurements.

Options



There are no measurement results under selected structure item. Measurements should be made.

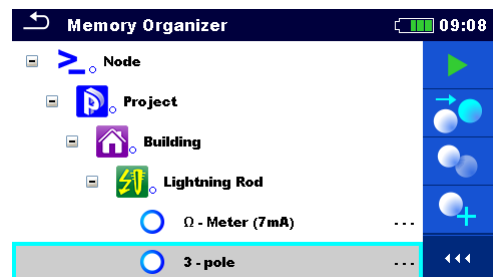

One or more measurement result(s) under selected structure item has failed. Not all measurements under selected structure item have been made yet.

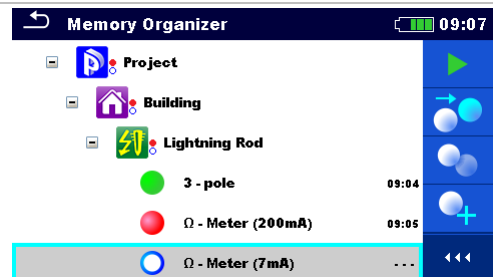

All measurements under selected structure item are completed but one or more measurement result(s) has failed.

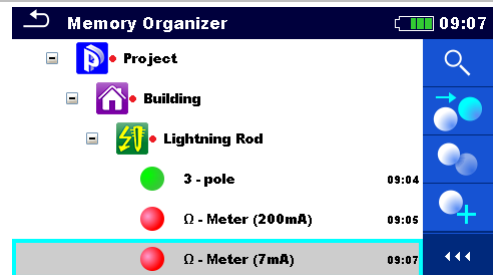

Note:

- There is no status indication if all measurement results under each structure item /sub-item have passed or if there is an empty structure item / sub-item (without measurements).

9.1.4 Operations in Tree menu

In the Memory organizer different actions can be taken with help of the control panel at the right side of the display. Possible actions depend on the selected element in the organizer.

9.1.4.1 Operations on measurements (finished or empty measurements)



Figure 9.3: A measurement is selected in the Tree menu

Options



Views results of measurement.
The instrument goes to the measurement memory screen.



Starts a new measurement.
The instrument goes to the measurement start screen.



Clones the measurement.
The selected measurement can be copied as an empty measurement under the same Structure item. Refer to chapter **9.1.4.7 Clone a measurement** for more information.



Copy & Paste a measurement.
The selected measurement can be copied and pasted as an empty measurement to any location in structure tree. Multiple “Paste” is allowed. Refer to chapter **9.1.4.10 Copy & Paste a measurement** for more information.



Adds a new measurement.
The instrument goes to the Menu for adding measurements. Refer to chapter **9.1.4.5 Add a new measurement** for more information.



Deletes a measurement.
Selected Measurement can be deleted. User is asked for confirmation before the deleting. Refer to chapter **9.1.4.12 Delete a measurement** for more information.

9.1.4.2 Operations on Structure items

The structure item must be selected first.

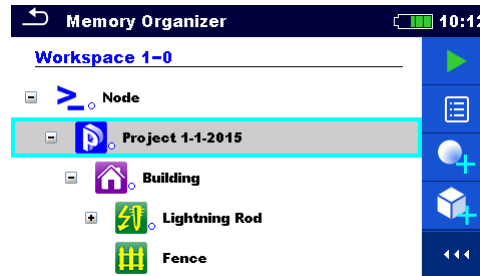

Figure 9.4: A structure project is selected in the Tree menu

Options



Starts a new measurement.

Type of measurement (Single test or Auto test) should be selected first. After proper type is selected, the instrument goes to Single Test or Auto Test selection screen. Refer to chapters **10.1 Selection modes**.



Saves a measurement.

Saving of measurement under the selected Structure project.



View / edit parameters and attachments.

Parameters and attachments of the Structure items can be viewed or edited. Refer to chapter **9.1.4.3 View / Edit parameters and attachments of a Structure** for more information.



Adds a new measurement.

The instrument goes to the menu for adding measurement into structure. Refer to chapter **9.1.4.5 Add a new measurement** for more information.



Adds a new Structure item.

A new Structure item can be added. Refer to chapter **9.1.4.4 Add a new Structure item** for more information.



Attachments.

Name and link of attachment is displayed.



Clones a Structure.

Selected Structure can be copied to same level in structure tree (clone). Refer to chapter **9.1.4.6 Clone a Structure item** for more information.



Copies & Paste a Structure.

Selected Structure can be copied and pasted to any allowed location in structure tree. Multiple "Paste" is allowed. Refer to chapter **9.1.4.8 Copy & Paste a Structure item** for more information.



Deletes a Structure item.

Selected Structure item and sub-items can be deleted. User is asked for confirmation before the deleting. Refer to chapter **9.1.4.11 Delete a Structure item** for more information.



Renames a Structure item.

Selected Structure item can be renamed via keypad. Refer to chapter **9.1.4.13 Rename a Structure item** for more information.

9.1.4.3 View / Edit parameters and attachments of a Structure

The parameters and their content are displayed in this menu. To edit the selected parameter, tap on it or press tab key followed by enter key to enter menu for editing parameters.

Procedure

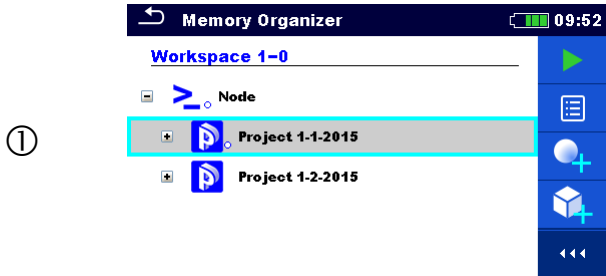

①

Select structure item to be edited.



②

Select Parameters in Control panel.

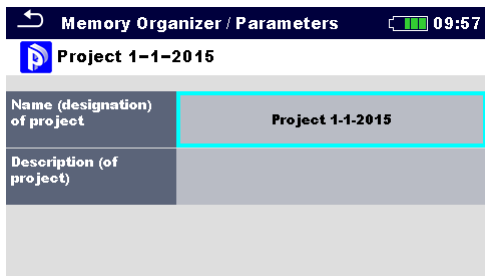

③

Example of Parameters menu.

In menu for editing parameters the parameter's value can be selected from a dropdown list or entered via keypad. Refer to chapter **6 Instrument operation** for more information about keypad operation.



②a

Select Attachments in Control panel.

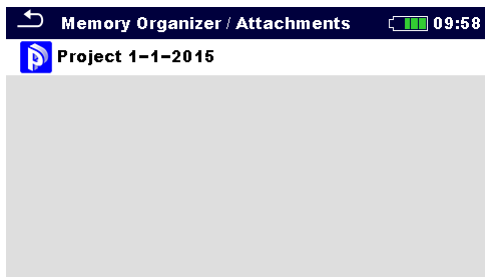

③b

Attachments
The name of attachment can be seen. Operation with attachments is not supported in the instrument.

9.1.4.4 Add a new Structure item

This menu is intended to add new structure item in the tree menu. A new structure item can be selected and then added in the tree menu.

Procedure

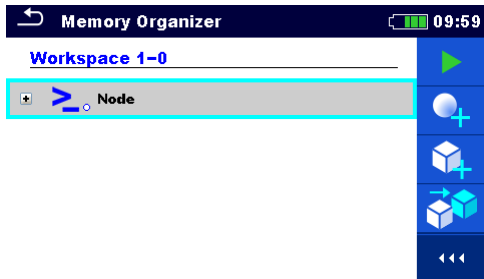
①  Default initial structure.

②  Select Add Structure in Control panel.

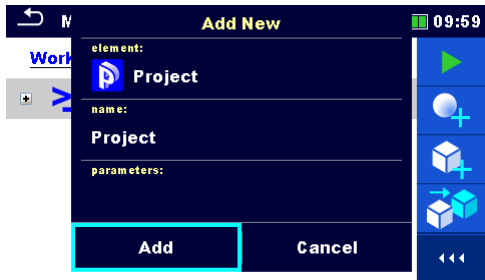
③  Add a new structure project menu.

④ a  The name of structure item can be edited.

④ b  Parameters of the Structure item can be edited.

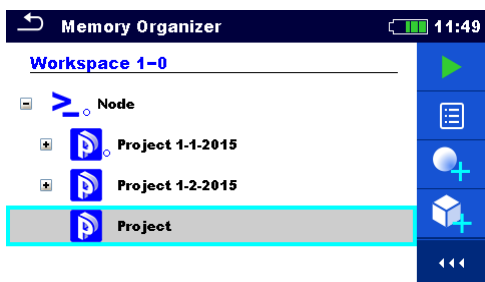
⑤  New project added.

9.1.4.5 Add a new measurement

In this menu new empty measurements can be set and then added in the structure tree. The type of measurement, measurement function and its parameters are first selected and then added under the selected Structure item.

Procedure

①		<p>Select level in structure where measurement will be added.</p>
②		<p>Select Add measurement in Control panel.</p>
③		<p>Add new measurement menu.</p>
④ a		<p>Type of test can be selected from this field. Options: Single Tests, Auto Tests. Tap on field or press the enter key to modify.</p>
④ b		<p>Last added measurement is offered by default. To select another measurement tap on field or press enter to open menu for selecting measurements.</p>
④ c		<p>Select parameter and modify it as described earlier. Refer to chapter 10.1.2 Setting parameters and limits of single tests for more information.</p>
⑤		<p>Adds the measurement under the selected Structure project in the tree menu.</p>
		<p>Returns to the structure tree menu without changes.</p>

⑥

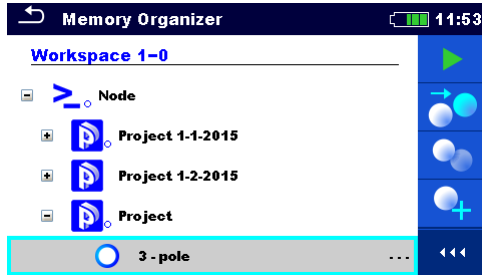

New empty measurement is added under the selected Structure project.

9.1.4.6 Clone a Structure item

In this menu selected structure item can be copied (cloned) to same level in the structure tree. Cloned structure item have same name as original.

Procedure

①

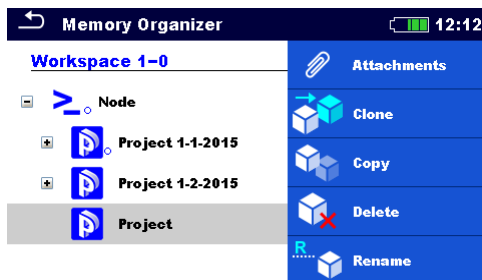

Select the structure item to be cloned.

②



Select Clone in Control panel.

③

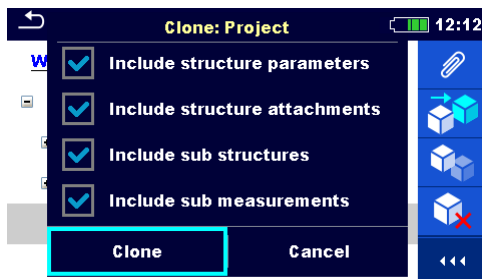

The Clone Structure menu is displayed. Sub-elements of the selected structure item can be marked or un-marked for cloning. Refer to chapter **9.1.4.9 Cloning and Pasting sub-elements of selected structure item** for more information.

④

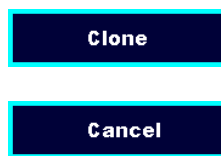

Selected structure item is copied (cloned) to same level in the structure tree.

Cloning is cancelled. No changes in the Structure tree.

⑤

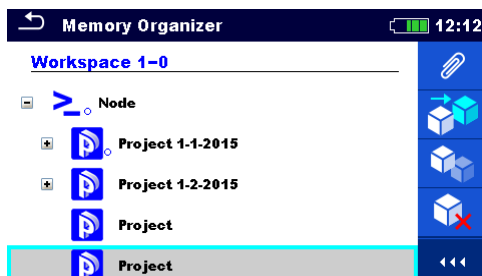

The new structure item is displayed.

9.1.4.7 Clone a measurement

By using this function a selected empty or finished measurement can be copied (cloned) as an empty measurement to the same level in the structure tree.

Procedure

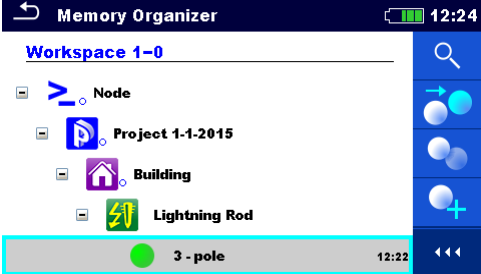
①  Select the measurement to be cloned.

②  Select Clone in Control panel.

③  A new empty measurement is displayed.

9.1.4.8 Copy & Paste a Structure item

In this menu selected Structure item can be copied and pasted to any allowed location in the structure tree.

Procedure

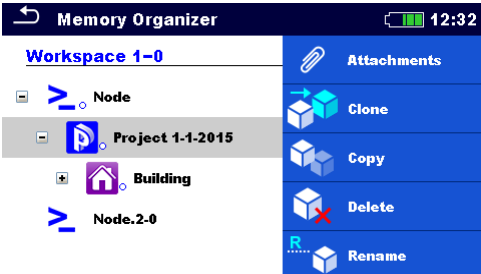
①  Select the structure item to be copied.

②  Select Copy in control panel.

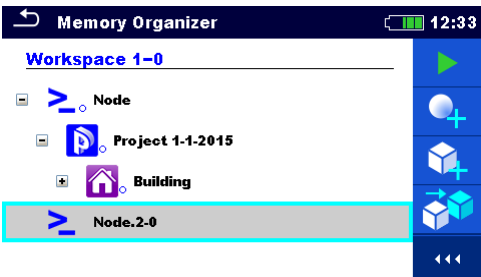
③  Select location where structure item should be copied.

④  Select Paste in Control panel.

⑤

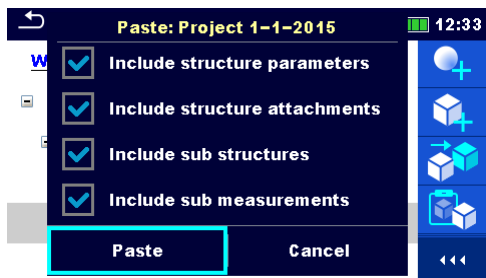

The Paste structure menu is displayed. Before copying it can be set which sub-elements of the selected structure item will be copied too. Refer to chapter **9.1.4.9 Cloning and Pasting sub-elements of selected structure item** for more information.

⑥

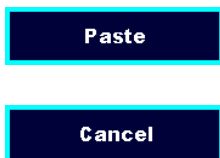

The selected structure item and elements are copied (pasted) to selected position in the tree structure.

Returns to the tree menu without changes.

⑦

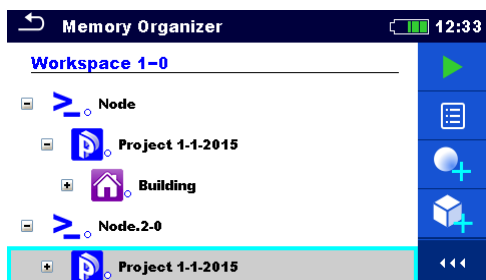

The new structure item is displayed.

Note:

- The Paste command can be executed one or more times.

9.1.4.9 Cloning and Pasting sub-elements of selected structure item

When structure item is selected to be cloned, or copied & pasted, additional selection of its sub-elements is needed. The following options are available:

Options

- Include structure parameters** Parameters of selected structure item will be cloned / pasted too.
- Include structure attachments** Attachments of selected structure item will be cloned / pasted too.
- Include sub structures** Structure items in sub-levels of selected structure item (sub-structures) will be cloned / pasted too.
- Include sub measurements** Measurements in selected structure item and sub-levels (sub-structures) will be cloned / pasted too.

9.1.4.10 Copy & Paste a measurement

In this menu selected measurement can be copied to any allowed location in the structure tree.

Procedure

①



Select the measurement to be copied.

②



Select Copy in Control panel.

③

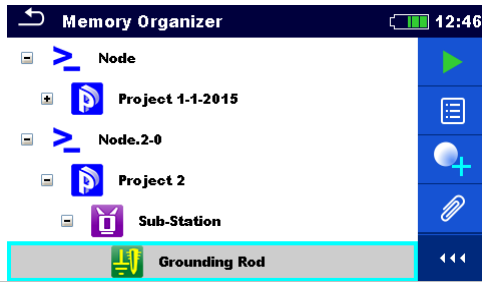

Select the location where measurement should be pasted.

④



Select Paste in Control panel.

⑤

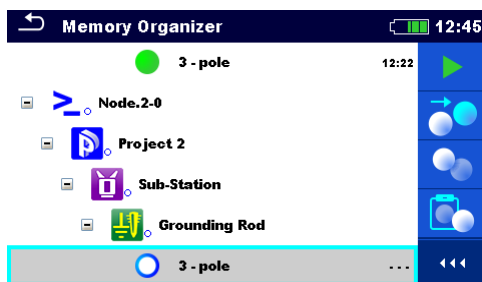

A new (empty) measurement is displayed in selected Structure item.

Note:

- ❑ The Paste command can be executed one or more times.

9.1.4.11 Delete a Structure item

In this menu selected Structure item can be deleted.

Procedure

①

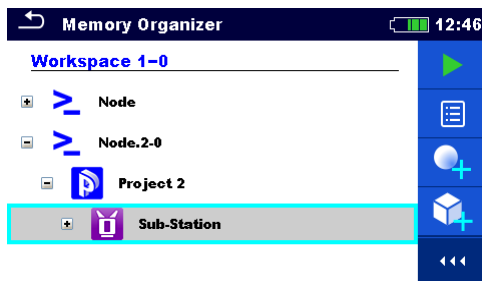

Select the structure item to be deleted.

②



Select Delete in Control panel.

③

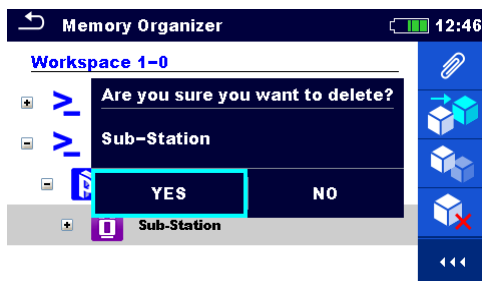

A confirmation window will appear.

④



Selected structure item and its sub-elements are removed.



Returns to the tree menu without changes.

⑤

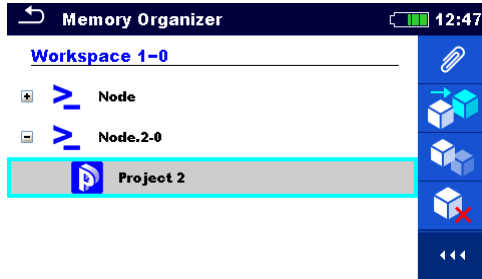

Structure without deleted structure item.

9.1.4.12 Delete a measurement

In this menu selected measurement can be deleted.

Procedure

①

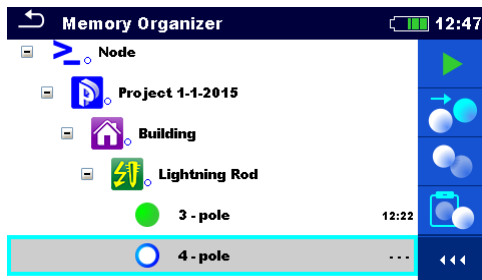

Select a measurement to be deleted.

②



Select Delete in Control panel.

③

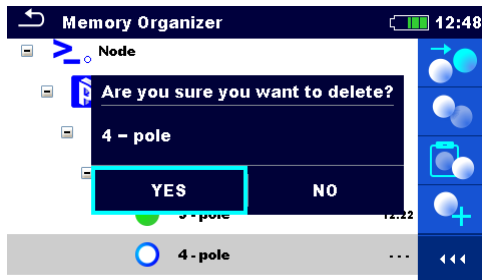

A confirmation window will appear.

④



Selected measurement is deleted.



Returns to the tree menu without changes.

⑤

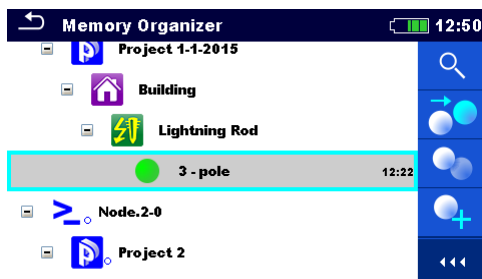

Structure without deleted measurement.

9.1.4.13 Rename a Structure item

In this menu selected Structure item can be renamed.

Procedure

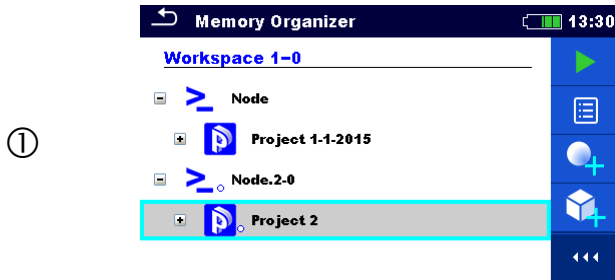

Select the structure item to be renamed.

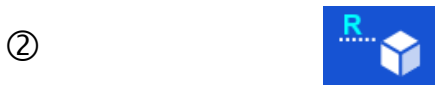

Select Rename in Control panel. Virtual keypad will appear on screen. Enter new text and confirm. Refer to chapter 6.3 **Virtual keyboard** for keypad operation.

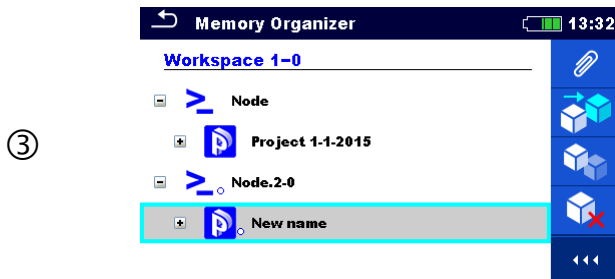

Structure item with the modified name.

9.1.4.14 Recall and Retest selected measurement

Procedure

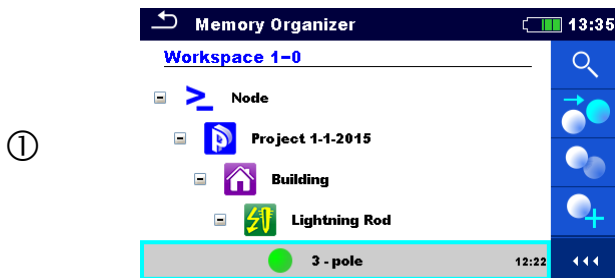

Select the measurement to be recalled.



Select Recall results in Control panel.

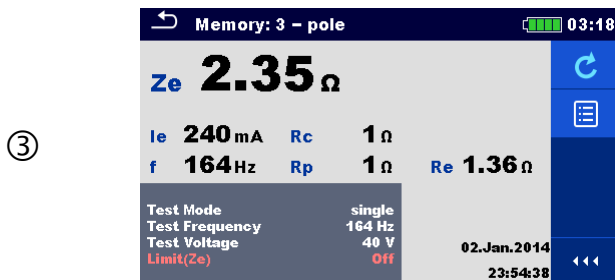

Measurement is recalled.

Parameters and limits can be viewed but cannot be edited.



Select Retest in Control panel.

⑤

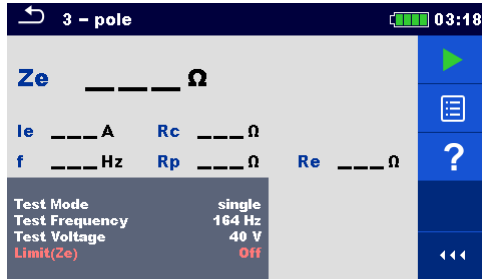

Measurement retest starting screen is displayed.

⑤a

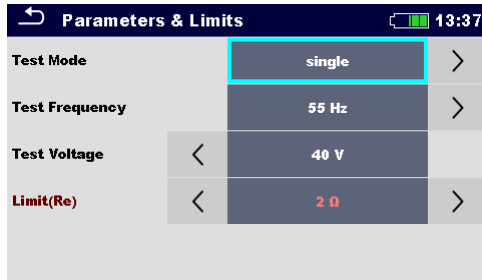

Parameters and limits can be viewed and edited.

⑥



Select Run in Control panel to retest the measurement.

⑦

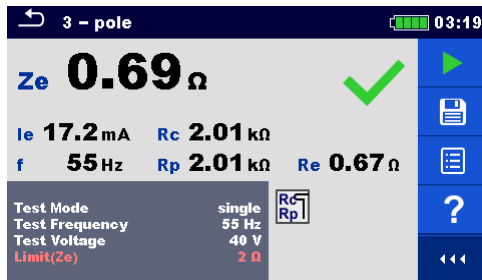

Results / sub-results after re-run of recalled measurement.

⑧



Select Save results in Control panel.

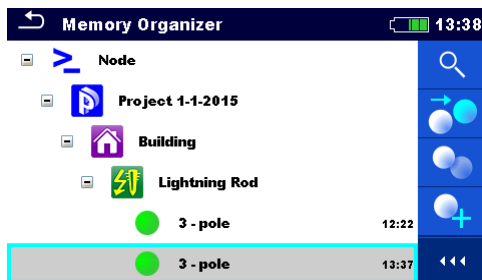

Retested measurement is saved under same structure item as original one. Refreshed memory structure with the new performed measurement is displayed.

10 Single tests

Single measurements and tests can be selected in the main Single tests menu or in Memory organizer's main and sub-menus.

10.1 Selection modes

In Single tests main menu four modes for selecting single tests are available.

Options



All

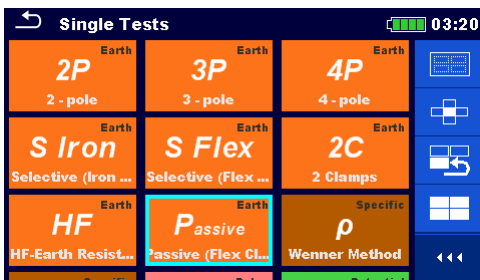

A single test can be selected from a list of all single tests. The single tests are always displayed in the same (default) order.



Last used



Last 9 made different single tests are displayed.



Groups

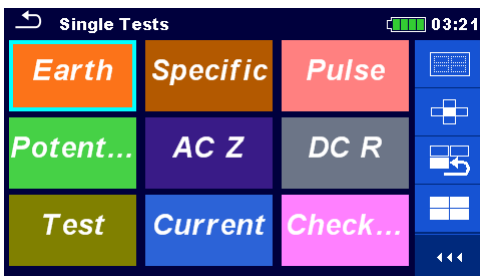

The single tests are divided into groups of similar tests.



Cross selector

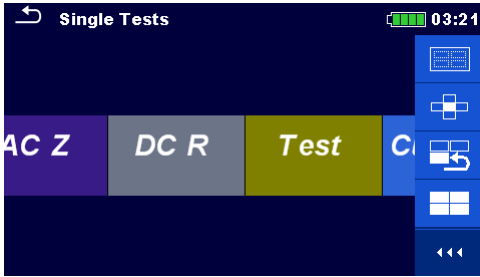

This selection mode is the fastest for working with the keypad. Groups of single tests are organized in a row.



For the selected group all single tests are displayed and easy accessible with up /down keys.

10.1.1 Single test screens

In the Single test screens measuring results, sub-results, limits and parameters of the measurement are displayed. In addition on-line statuses, warnings and other info are displayed.

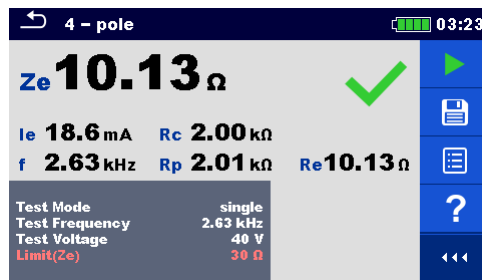

Figure 10.1: Single test screen organization Example of 4 -pole measurement

Single test screen organization:



Main line:

- ESC touch key
- function name
- battery status
- clock



Control panel (available options)

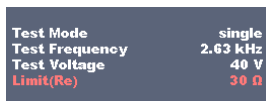

Parameters (white) and limits (red)

Result field:

- main result(s)
- sub-result(s)
- PASS / FAIL indication
- number of screens



Warning symbols and message field

10.1.2 Setting parameters and limits of single tests

Procedure

①

Select the test or measurement.

The test can be entered from:

- Single tests menu or
- Memory organizer menu once the empty measurement was created under selected structure.

②

Select Parameters in Control panel.

③

Select parameter to be edited or limit to be set.

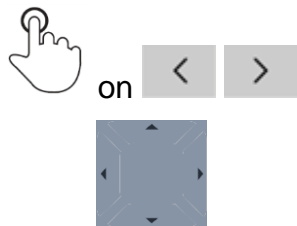

Set parameter / limit value.

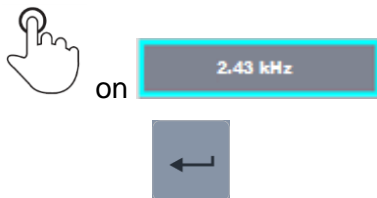

Enter Set value menu.

③a

Set value menu.

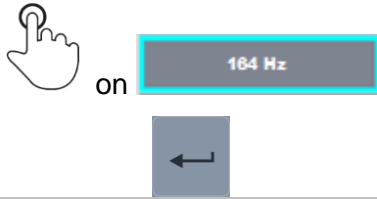

Accepts a new parameter or limit value and exits Set value menu.

④



Accepts the new parameters and limit values.

10.1.3 Single test result screen

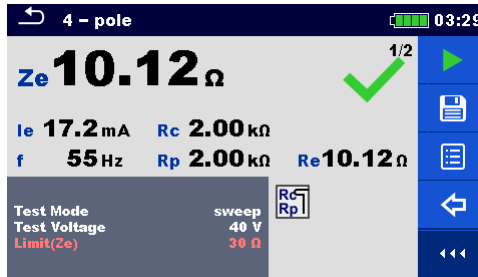

Figure 10.2: Single test result screen Example of 4 -pole measurement

Options (after measurement is finished)



Starts a new measurement.



Saves the result.

A new measurement was selected and started from a Structure object in the structure tree:

- the measurement will be saved under the selected Structure object.

A new measurement was started from the Single test main menu:

- saving under the last selected Structure object will be offered by default. The user can select another Structure object or create a new Structure object.

- By pressing the  key in Memory organizer menu the measurement is saved under selected location.

An empty measurement was selected in structure tree and started:

- the result(s) will be added to the measurement. The measurement will change its status from 'empty' to 'finished'.

An already carried out measurement was selected in structure tree, viewed and then restarted:

- a new measurement will be saved under the selected Structure object.



Opens help screens.



Opens menu for changing parameters and limits of selected measurements. Refer to chapter **10.1.2 Setting parameters**



Test Mode	single
Test Frequency	2.63 kHz
Test Voltage	40 V
Limit(Re)	30 Ω

and limits of single tests for more information how to change measurement parameters and limits.



long on

Ze 10.13 Ω ✔

le 18.6 mA Rc 2.00 kΩ

f 2.63 kHz Rp 2.01 kΩ Re 10.13 Ω

Enters cross selector to select test or measurement.

10.1.4 Graph view

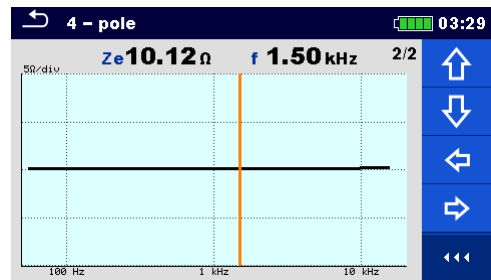
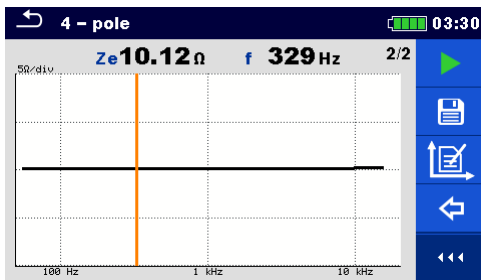

Figure 10.3: Graph result screen (Example of 4-pole sweep measurement)

Options



Plot edit. Opens control panel for editing graphs.



Increase / decrease scale factor (y-axis).



Move cursor to the previous / next value (x-axis).



Select cursor position (x-axis).



Exits from editing graphs.

10.1.5 Recall single test result screen

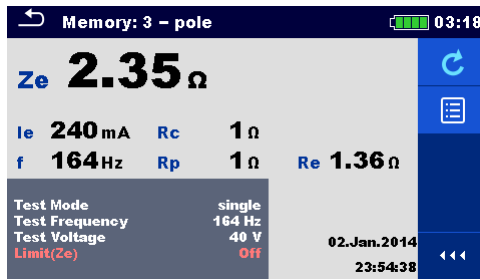

Figure 10.4: Recalled results of selected measurement, example of 4 -pole measurement recalled results

Options



Retest

Enters starting screen for a new measurement.

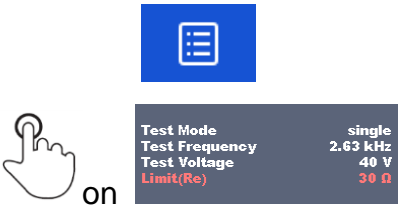

Opens menu for changing parameters and limits of selected measurements. Refer to chapter **10.1.2 Setting parameters and limits of single tests** for more information how to change measurement parameters and limits.



Selects previous / next result screen.



Selects view of results at different test frequencies (sweep mode).



11 Tests and Measurements

11.1 Earth Measurements [Ze and Re]

Result of Earth measurement is one of the most important parameters for protection against electric shock. Main installation earthing arrangements, lightning systems, local earthings, soil resistivity, etc. can be verified with the Earth tester.

The MI 3290 Earth Analyser is able to carry out Earth measurement using different methods. The appropriate one is selected by the operator depending on the particular earthing system to be tested.

Earth		Measurement	Test Mode		Graph	LF	HF	Filter	Test Voltage
Impedance	Resistance								
Ze	Re	2 – pole	single	sweep	Ze (f)	55 Hz	15 kHz	FFT	20/40 V
		3 – pole	single	sweep	Ze (f)	55 Hz	15 kHz	FFT	20/40 V
		4 – pole	single	sweep	Ze (f)	55 Hz	15 kHz	FFT	20/40 V
Zsel	/	Selective (Iron Clamp)	single	sweep	Zsel (f)	55 Hz	1,5 kHz	FFT	40 V
Ze		2 Clamps	cont.	/	/	82 Hz	329 Hz	FFT	40 V
/	Re	HF Earth Resistance (25 kHz)	single	/	/	/	25 kHz	FFT	40 V
Ztot	/	Selective (Flex Clamps 1 – 4)	single	sweep	Ztot (f) Zsel1-4 (f)	55 Hz	1,5 kHz	FFT	40 V
	/	Passive (Flex Clamps 1 – 4)	cont.	/	/	45 Hz	150 Hz	FFT	/

Table 11.1: Available Earth measurements in the MI 3290



11.1.1 2 – pole Measurement

The two-pole measurement can be used if there is a well-grounded auxiliary terminal available (e.g. source/ distribution earthings via the neutral conductor, water pipeline...). The main advantage of this method is that no test probes are needed for the test. The method is fast and relatively reliable.

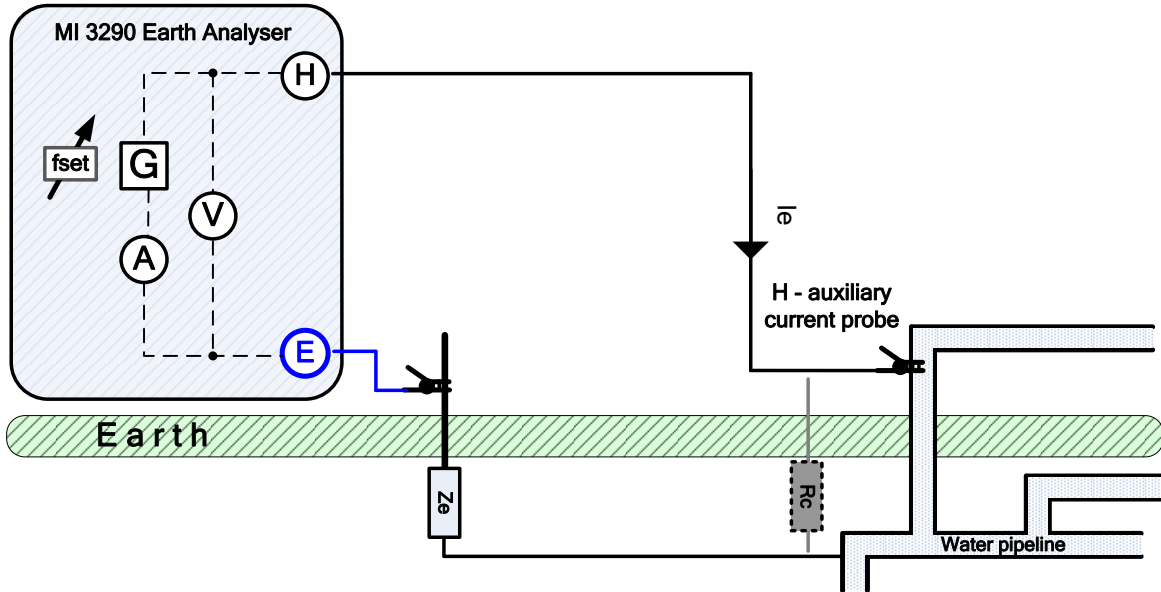

Figure 11.2: 2 – pole measurement example

During the measurement a sinusoidal current I_e is injected into the earth through an auxiliary probe (H). The impedance of the auxiliary probe (H) should be as low as possible in order to inject a high test current. The impedance R_c can be decreased by using more probes in parallel or using an auxiliary earthing system as the auxiliary probe. A higher injected current improves the immunity against spurious earth currents. The earth impedance Z_e is determined from the voltage/current ratio. Usually the impedance R_c is much lower than Z_e . In this case the result can be considered as $\approx Z_e$.

$$Z_e = \frac{U_{H-E} [V]}{I_e [A]} = [\Omega] \quad \text{where} \quad Z_e \gg R_c$$

- Z_e Earth impedance
- R_e Earth resistance (excluding reactance)
- R_c Impedance of auxiliary current probe (H)
- I_e Injected test current
- U_{H-E} Test voltage between H and E terminal
- f_{set} Test frequency

Refer to **Appendix C – Functionality and placing of test probes** for more information how to place the auxiliary current probe (H).

Test can be started from the 2 - pole measurement window. Before carrying out a test the following parameters (Test Mode, Test Voltage, Test Frequency and Limit (Ze)) can be edited.

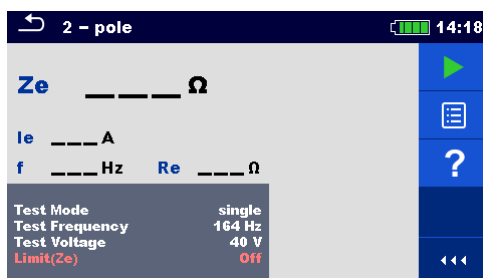

Figure 11.3: 2 - pole measurement menu

Test parameters for 2 – pole:

Test Mode	Set test mode: [single, sweep]
Test Frequency*	Set test frequency: [55 Hz, 82 Hz, 164 Hz, 329 Hz, 659 Hz, 1.31 kHz, 1.50 kHz, 2.63 kHz, 3.29 kHz, 6.59 kHz, 13.1 kHz, 15.0 kHz]
Test Voltage	Set test voltage: [20 V or 40 V]
Limit (Ze)	Limit value selection: [OFF, 0.1 Ω – 5.00 kΩ]

*single test mode only.

2-pole measurement procedure:

- Select the 2-pole measurement function.
- Set the test parameters (mode, voltage, frequency and limit).
- Connect the test leads to the instrument and to the test object.
- Press the Run key to start the measurement.
- Wait until the test result is displayed on the screen.
- Press the cursor keys to toggle between graph view and result view (optional).
- Save results (optional).

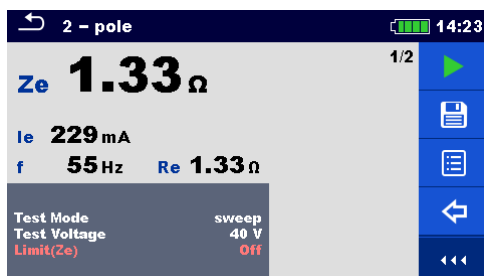

Figure 11.4: Example of 2-pole measurement result

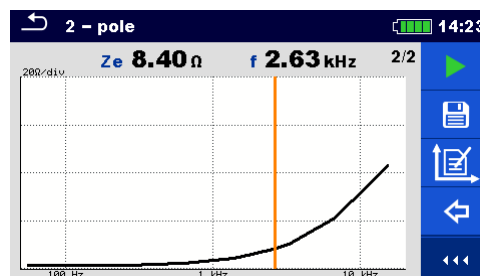

Figure 11.5: Example of 2-pole measurement graph view

Notes:

- Consider displayed warnings when starting the measurement!
- High noise currents and voltages in earth could influence the measurement results. The tester displays the “noise” warning in this case.
- When measuring at high frequencies use the guard terminal and shielded cable (H).

Notes related to probes:

- High impedance of H probe could influence the measurement results.
- Probes must be placed at a sufficient distance from the measured object.



11.1.2 3 – pole Measurement

The three-pole measurement is the standard earthing test method. It is the only choice if there is no well earthed auxiliary terminal available. The measurement is performed with two earthing probes. The drawback if using three wires is that the contact resistance of E terminal is added to the result.

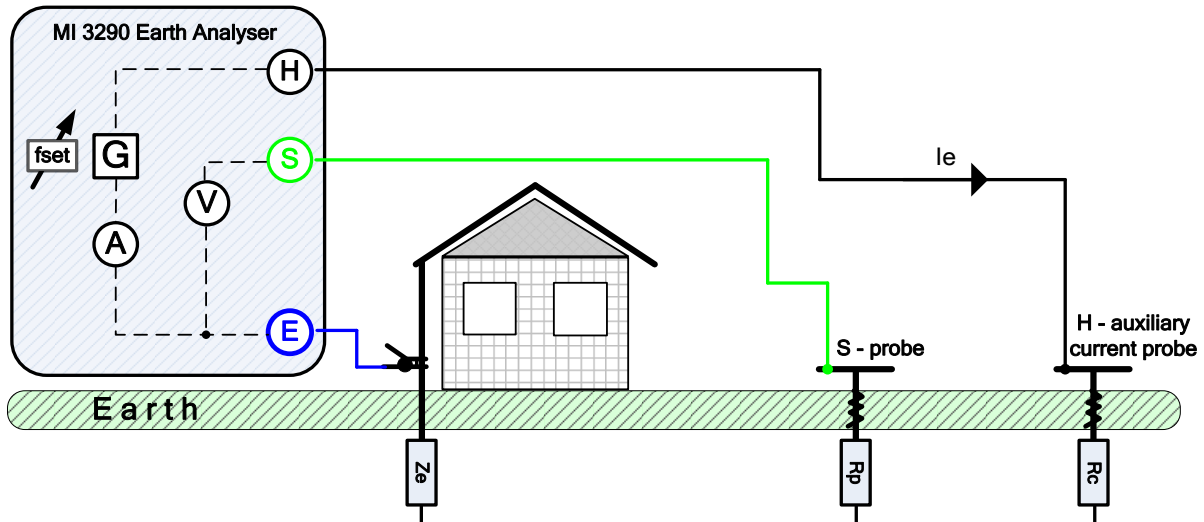

Figure 11.6: 3 – pole measurement example

During the measurement a sinusoidal current I_e is injected into the earth through an auxiliary current probe (H). The impedance of the auxiliary probe (H) should be as low as possible in order to inject a high test current. The impedance R_c can be decreased by using more probes in parallel. A higher injected current improves the immunity against spurious earth currents. The voltage drop is measured by auxiliary potential probe (S). The earth impedance Z_e is determined from the voltage/current ratio.

In the example following earth impedance is measured at a set frequency:

$$Z_e = \frac{U_{S-E} [V]}{I_e [A]} = [\Omega]$$

where:

Z_e	Earth impedance
R_e	Earth resistance (excluding reactance)
R_c	Impedance of auxiliary current probe (H)
R_p	Impedance of auxiliary potential probe (S)
I_e	Injected test current
U_{S-E}	Test voltage between S and E terminal
f_{set}	Test frequency

Refer to **Appendix C – Functionality and placing of test probes** for more information how to place the earth auxiliary current (H) and potential probe (S).

Test can be started from the 3 - pole measurement window. Before carrying out a test the following parameters (Test Mode, Test Voltage, Test Frequency and Limit (Ze)) can be edited.

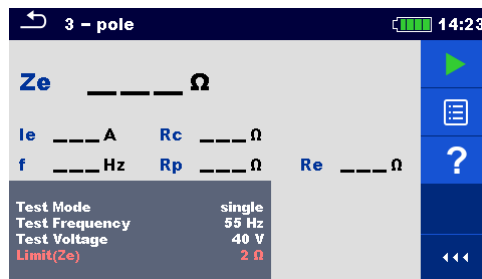

Figure 11.7: 3 - pole measurement menu

Test parameters for 3 – pole:

Test Mode	Set test mode: [single, sweep]
Test Frequency*	Set test frequency: [55 Hz, 82 Hz, 164 Hz, 329 Hz, 659 Hz, 1.31 kHz, 1.50 kHz, 2.63 kHz, 3.29 kHz, 6.59 kHz, 13.1 kHz, 15.0 kHz]
Test Voltage	Set test voltage: [20 V or 40 V].
Limit (Ze)	Limit value selection: [OFF, 0.1 Ω – 5.00 k Ω]

*single test mode only.

3-pole Measurement procedure:

- Select the 3-pole measurement function.
- Set the test parameters (mode, voltage, frequency and limit).
- Connect the test leads to the instrument and to the test object.
- Press the Run key to start the measurement.
- Wait until the test result is displayed on the screen.
- Press the cursor keys to toggle between graph view and result view (optional).
- Save results (optional).

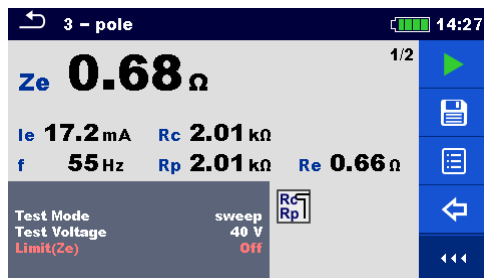

Figure 11.8: Example of 3-pole measurement result

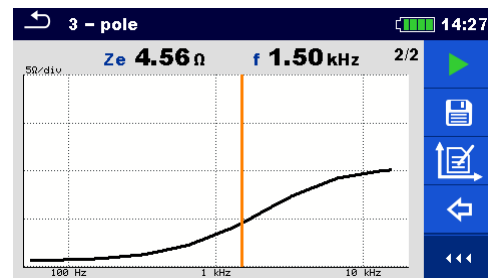

Figure 11.9: Example of 3-pole measurement graph view

Notes:

- Consider displayed warnings when starting the measurement!
- High noise currents and voltages in earth could influence the measurement results. The tester displays the “noise” warning in this case.
- When measuring at high frequencies use the guard terminal and shielded cable (H).

Notes (Probes):

- High impedance of S and H probes could influence the measurement results. In this case, “Rp” and “Rc” warnings are displayed. There is no pass / fail indication in this case.
- Probes must be placed at a sufficient distance from the measured object.



11.1.3 4 – pole Measurement

The advantage for using of four-pole test is that the leads and contact resistances between measuring terminal E and tested item do not influence the measurement.

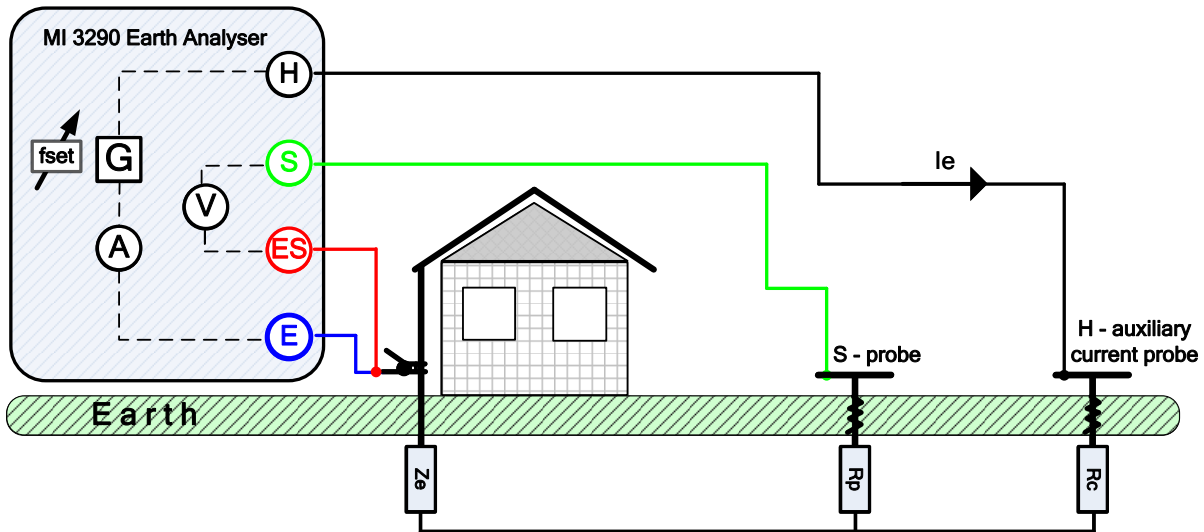

Figure 11.10: 4 – pole example

During the measurement a sinusoidal current I_e is injected into the earth through an auxiliary current probe (H). The impedance of the auxiliary probe (H) should be as low as possible in order to inject a high test current. The impedance R_c can be decreased by using more probes in parallel. A higher injected current improves the immunity against spurious earth currents. The differential voltage drop is measured by auxiliary potential probe (S) and (ES) terminal. The earth impedance Z_e is determined from the voltage/current ratio.

In the example following earth impedance is measured:

$$Z_e = \frac{U_{S-ES} [V]}{I_e [A]} = [\Omega]$$

where:

- Z_e Earth impedance
- R_e Earth resistance (excluding reactance)
- R_c Impedance of auxiliary current probe (H)
- R_p Impedance of auxiliary potential probe (S)
- I_e Injected test current
- U_{S-ES} Test voltage between S and ES terminal
- f_{set} Test frequency

Refer to **Appendix C – Functionality and placing of test probes** for more information how to place the earth auxiliary current (H) and potential probe (S).

Test can be started from the 4 - pole measurement window. Before carrying out a test the following parameters (Test Mode, Test Voltage, Test Frequency and Limit (Ze)) can be edited.

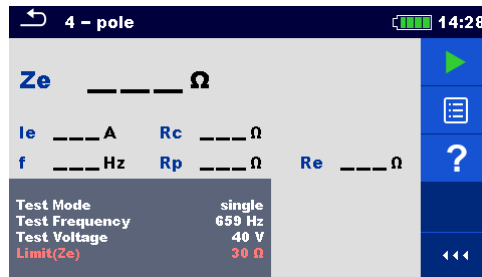

Figure 11.11: 4 - pole measurement menu

Test parameters for 4 – pole:

Test Mode	Set test mode: [single, sweep].
Test Frequency*	Set test frequency: [55 Hz, 82 Hz, 164 Hz, 329 Hz, 659 Hz, 1.31 kHz, 1.50 kHz, 2.63 kHz, 3.29 kHz, 6.59 kHz, 13.1 kHz, 15.0 kHz].
Test Voltage	Set test voltage: [20 V or 40 V].
Limit (Ze)	Limit value selection: [OFF, 0.1 Ω – 5.00 k Ω].

*single test mode only.

4-pole Measurement procedure:

- Select the 4-pole measurement function.
- Set the test parameters (mode, voltage, frequency and limit).
- Connect the test leads to the instrument and to the test object.
- Press the Run key to start the measurement.
- Wait until the test result is displayed on the screen.
- Press the cursor keys to toggle between graph view and result view (optional).
- Save results (optional).

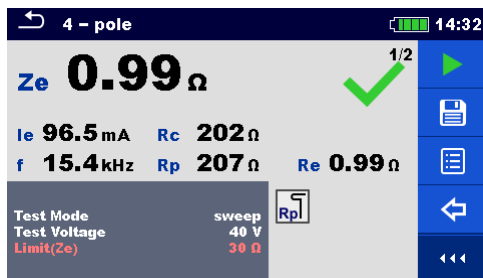

Figure 11.12: Example of 4-pole measurement result

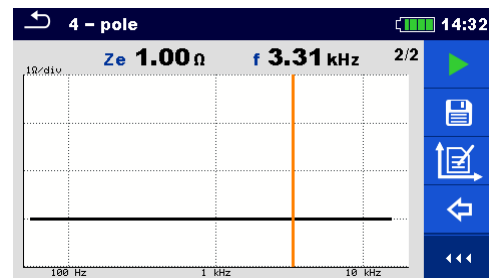

Figure 11.13: Example of 4-pole measurement graph view

Notes:

- Consider displayed warnings when starting the measurement!
- High noise currents and voltages in earth could influence the measurement results. The tester displays the “noise” warning in this case.
- When measuring at high frequencies use the guard terminal and shielded cable (H).

Notes (Probes):

- High impedance of S and H probes could influence the measurement results. In this case, “Rp” and “Rc” warnings are displayed. There is no pass / fail indication in this case.
- Probes must be placed at a sufficient distance from the measured object.



11.1.4 Selective (Iron Clamp) Measurement

This measurement is applicable for measuring selective earth resistances of individual earthing points in an earthing system. The earthing rods do not need to be disconnected during measurement. 4-pole wiring is used for this measurement.

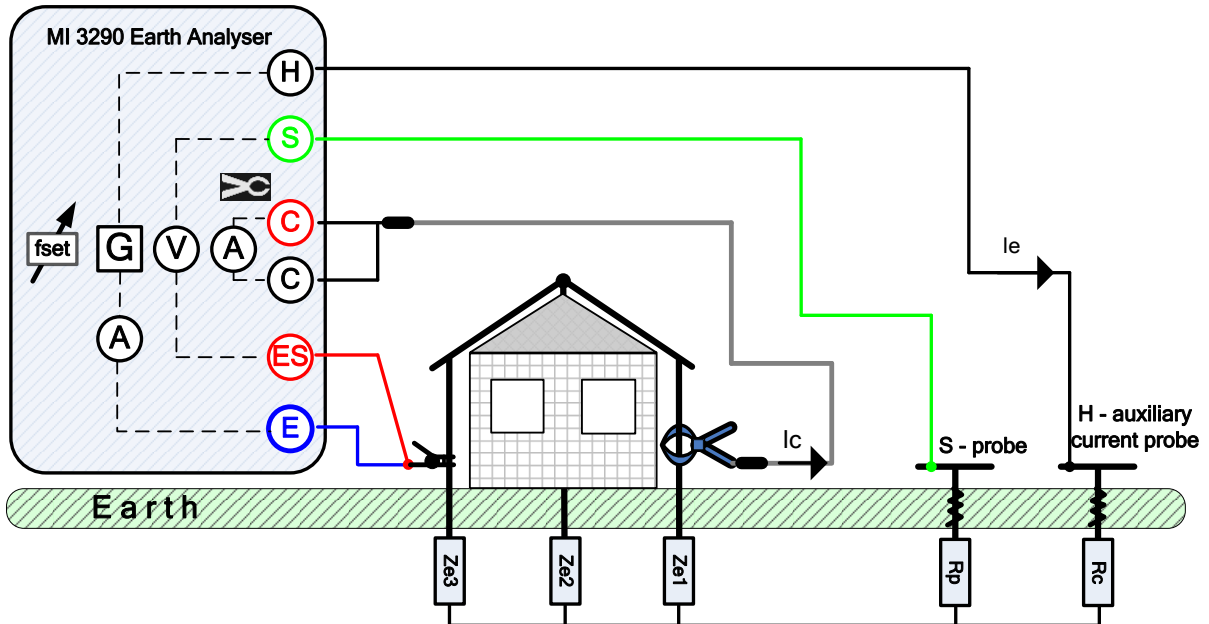

Figure 11.14: Selective (Iron Clamp) example

During the measurement a sinusoidal current I_e is injected into the earth through an auxiliary current probe (H). The impedance of the auxiliary probe (H) should be as low as possible in order to inject a high test current. The impedance R_c can be decreased by using more probes in parallel. A higher injected current improves the immunity against spurious earth currents. The voltage drop is measured by auxiliary potential probe (S) and (ES) terminal. The selective current I_c is measured through the earthing electrode (Z_{e1}) selected by the user. The selected earth impedance Z_{sel} is determined from the voltage/current (external current clamp – I_c) ratio.

According to the example selective (individual) earth impedance is measured:

$$Z_{sel} = \frac{U_{S-ES} [V]}{I_c [A] * N} = \frac{U_{S-ES} [V]}{I_{Ze1} [A]} = [\Omega] \quad I_c = \frac{Z_{e1} \parallel Z_{e2} \parallel Z_{e3} * I_e}{Z_{e1}} = [A]$$

where:

- Z_{sel} Selected Earth impedance
- Z_{e1-3} Earth impedance
- R_c Impedance of auxiliary current probe (H)
- R_p Impedance of auxiliary potential probe (S)
- I_e Injected test current
- I_c Measured current with Iron clamp
- U_{S-ES} Test voltage between S and ES terminal
- N Turn ratio of current clamps (depending on the model)
- f_{set} Test frequency

Refer to **Appendix C – Functionality and placing of test probes** for more information how to place the earth auxiliary current (H) and potential probe (S).

Test can be started from the Selective (Iron Clamp) measurement window. Before carrying out a test the following parameters (Test Mode, Clamp Type, Test Frequency and Limit (Zsel)) can be edited.

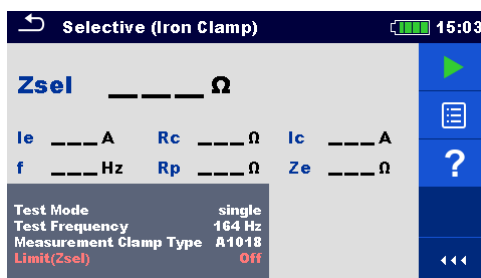

Figure 11.15: Selective (Iron Clamp) measurement menu

Test parameters for Selective (Iron Clamp):

Test Mode	Set test mode: [single, sweep].
Test Frequency*	Set test frequency: [55 Hz, 82 Hz, 164 Hz, 329 Hz, 659 Hz, 1.31 kHz, 1.50 kHz].
Clamp type	Set clamp type: [A1018].
Limit (Zsel)	Limit value selection: [OFF, 0.1 Ω – 5.00 k Ω].

*single test mode only.

Selective (Iron Clamp) Measurement procedure:

- Select the Selective (Iron Clamp) measurement function.
- Set the test parameters (mode, clamp type, frequency and limit).
- Connect the test leads and clamp to the instrument and to the test object.
- Press the Run key to start the measurement.
- Wait until the test result is displayed on the screen.
- Press the cursor keys to toggle between graph view and result view (optional).
- Save results (optional).

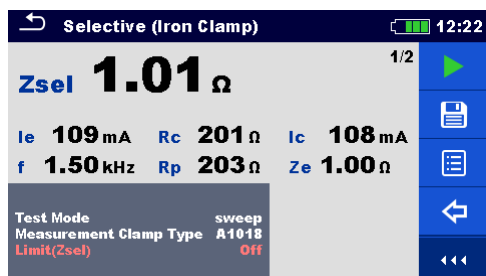

Figure 11.16: Example of Selective (Iron Clamp) measurement result

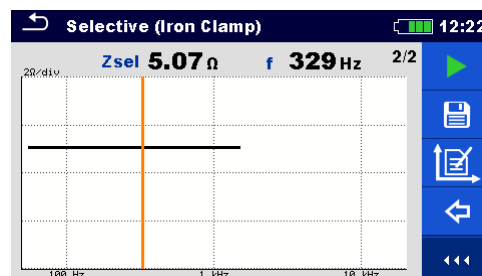

Figure 11.17: Example of Selective (Iron Clamp) measurement graph view

Notes:

- Consider displayed warnings when starting the measurement!
- High noise currents and voltages in earth could influence the measurement results. The tester displays the “noise” warning in this case.
- When measuring at high frequencies use the guard terminal and shielded cable (H).

Notes (Probes):

- High impedance of S and H probes could influence the measurement results. In this case, “Rp” and “Rc” warnings are displayed. There is no pass / fail indication in this case.
- Probes must be placed at a sufficient distance from the measured object.



11.1.5 2 Clamps Measurement

This measurement system is used when measuring earth impedances of grounding rods, cables, under- earth connections, etc. The measuring method needs a closed loop to be able to generate test currents. It is especially suitable for use in urban areas because there is usually no possibility to place the test probes.

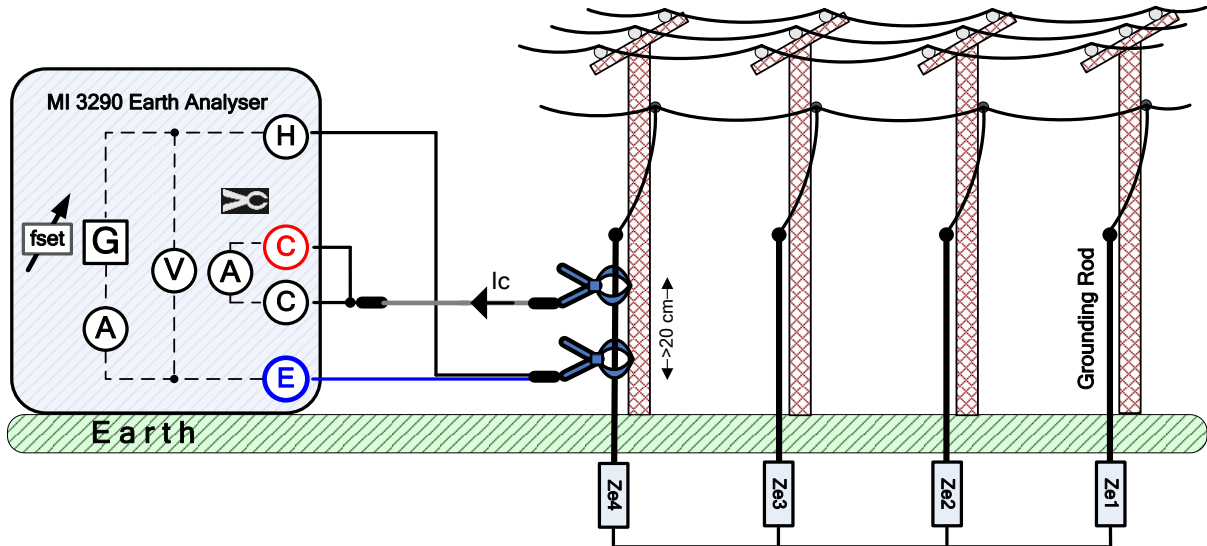

Figure 11.18: 2 Clamps example

The driver (generator) clamp injects a voltage in the earthing system. The injected voltage generates a test current in the loop. If the total loop earth impedance of the electrodes Z_{e1} , Z_{e2} , Z_{e3} and Z_{e4} connected in parallel is much lower than the impedance of tested electrode Z_{e4} , then the result can be considered as $\approx Z_{e4}$. Other individual impedance can be measured by embracing other electrodes with the current clamps.

According to the example individual earth impedance is measured:

$$Z_{e4} + (Z_{e1} \parallel Z_{e2} \parallel Z_{e3}) = \frac{U_{H-E} [V] * \frac{1}{N}}{I_c [A]} = [\Omega]$$

where:

- Z_{e1-e4} Earth impedance
- I_c Measured current with Iron clamp
- U_{H-E} Test voltage between H and E terminal
- N Driver (generator) clamp transformation ratio
(depending on the clamp model)
- f_{set} Test frequency

Note:

- 2 Clamps earth resistance test is sometimes called “loop resistance test”.

Test can be started from the 2 Clamps measurement window. Before carrying out a test the following parameters (Measurement Clamp Type, Test Frequency, Generator Clamp Type and Limit (Ze)) can be edited.

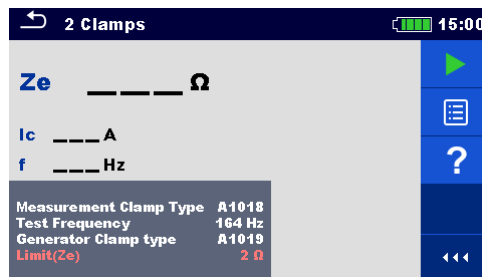

Figure 11.19: 2 Clamps measurement menu

Test parameters for 2 Clamps:

Measurement Clamp type	Set measurement clamp type: [A1018].
Test Frequency	Set test frequency: [82 Hz, 164 Hz, 329 Hz].
Generator Clamp type	Set generator clamp type: [A1019].
Limit (Ze)	Limit value selection [OFF, 0.1 Ω – 40 Ω].

2 Clamps Measurement procedure:

- Select the 2 Clamps measurement function.
- Set the test parameters (clamp type, frequency and limit).
- Connect the clamps to the instrument and to the test object.
- Press the Run key to start the measurement.
- Wait until the test result is displayed on the screen.
- Press the Run key again to stop the measurement.
- Save results (optional).

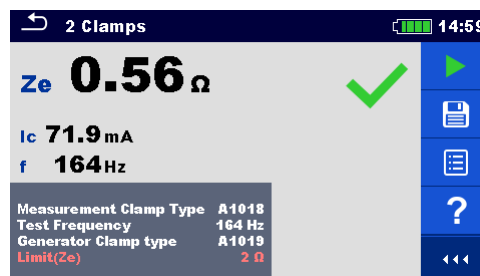

Figure 11.20: Example of 2 Clamps measurement result

Notes:

- Consider displayed warnings when starting the measurement!
- High noise currents and voltages in earth could influence the measurement results. The tester displays the “noise” warning in this case.



11.1.6 HF-Earth Resistance (25 kHz) Measurement

The high frequency measuring method offers the advantage of eliminating the influence of adjacent tower earthings connected by overhead grounding wire (automatic compensation of inductive components). 3-pole wiring is used for this measurement.

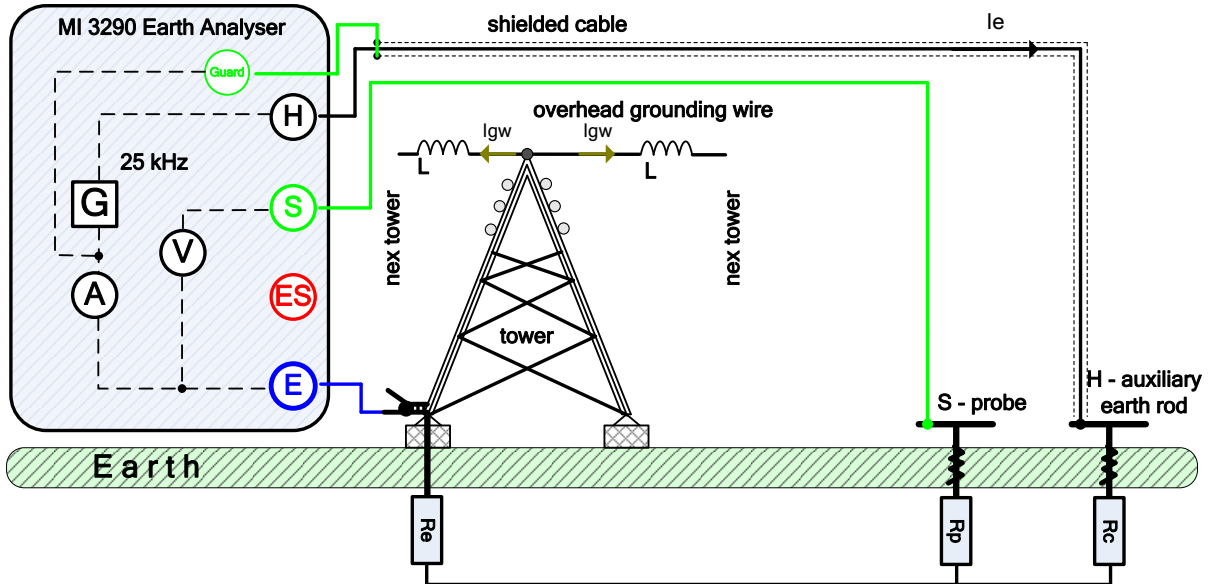

Figure 11.21: HF-Earth Resistance (25 kHz) example

During the measurement a (25 kHz) sinusoidal current I_e is injected into the earth through an auxiliary probe (H). The impedance of the auxiliary probe (H) should be as low as possible in order to inject a high test current. The impedance R_c can be decreased by using more probes in parallel. A higher injected current improves the immunity against spurious earth currents. The voltage drop is measured by auxiliary potential probe (S). The earth resistance R_e is determined from the voltage/current ratio. In the example following earth resistance is measured:

$$R_e = \frac{U_{S-E} [V]}{I_e [A]} = [\Omega]$$

where:

- R_e Earth resistance (excluding reactance)
- R_c Impedance of auxiliary current probe (H)
- R_p Impedance of auxiliary potential probe (S)
- I_e Injected test current
- U_{S-E} Test voltage between S and E terminal
- I_{gw} Overhead grounding wire current

Note:

- Automatic compensation of inductive components.

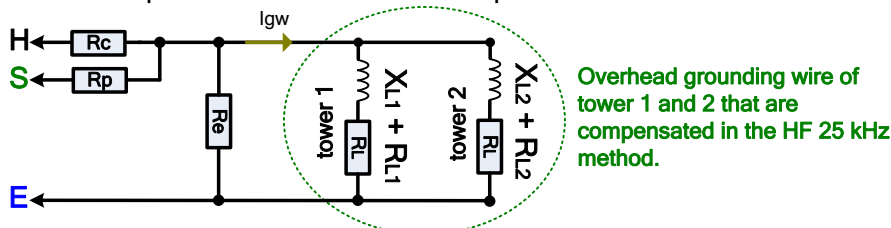

Figure 11.22: Compensation in HF 25 kHz method

- Typical ground wire inductance in power lines 0.2 mH – 200 mH.

Test can be started from the HF-Earth Resistance (25 kHz) measurement window. Before carrying out a test the following parameter (Limit (Re)) can be edited.

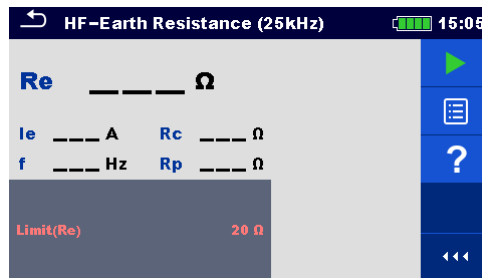

Figure 11.23: HF-Earth Resistance (25 kHz) measurement menu

Test parameters for HF-Earth Resistance (25 kHz):

Limit (Re) Limit value selection [OFF, 1 Ω – 100 Ω].

HF-Earth Resistance (25 kHz) Measurement procedure:

- Select the HF-Earth Resistance (25 kHz) Measurement function.
- Set a test parameter (limit).
- Connect the test leads to the instrument and to the test object. Use shielded cable (H) with guard connection.
- Press the Run key to start the measurement.
- Wait until the test result is displayed on the screen.
- Save results (optional).

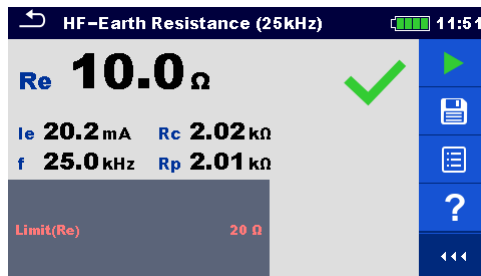

Figure 11.24: Example of HF-Earth Resistance (25 kHz) measurement result

Notes:

- Consider displayed warnings when starting the measurement!
- High noise currents and voltages in earth could influence the measurement results. The tester displays the “noise” warning in this case.

Notes (Probes):

- High impedance of S and H probes could influence the measurement results. In this case, “Rp” and “Rc” warnings are displayed. There is no pass / fail indication in this case.
- Probes must be placed at a sufficient distance from the measured object.



11.1.7 Selective (Flex Clamps 1 - 4) Measurement

This measurement is applicable for measuring selective earth resistances of individual earthing points in an earthing system. The earthing rods do not need to be disconnected during measurement. 4-pole wiring is used for this measurement.

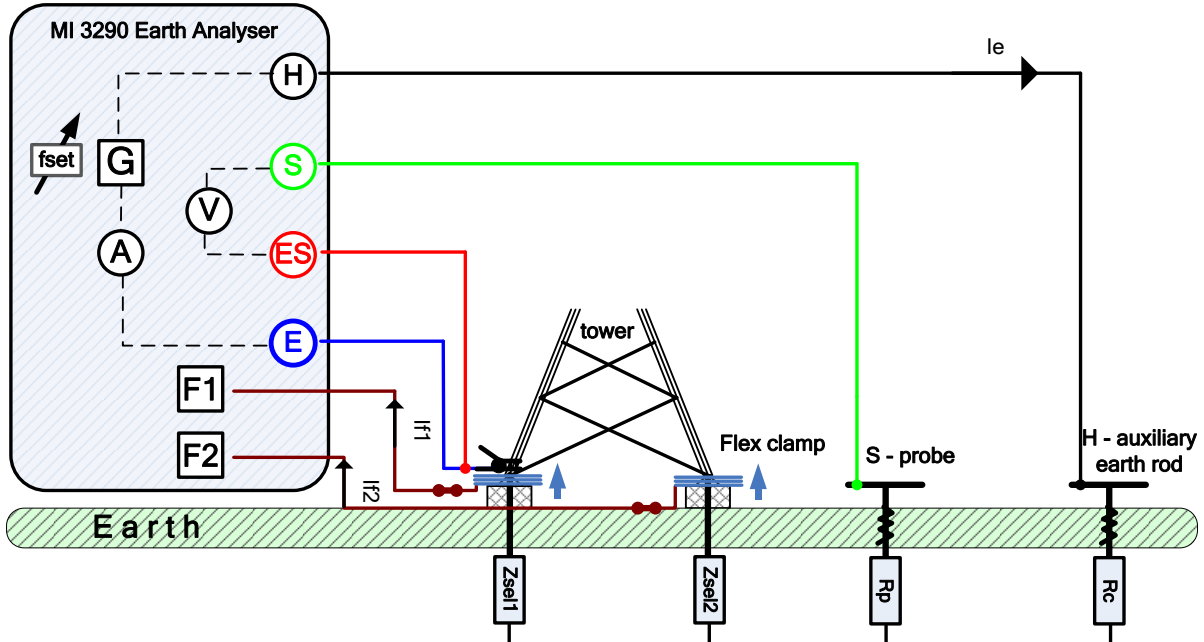

Figure 11.25: Selective (Flex Clamps 1-4) example

During the measurement a sinusoidal current I_e is injected into the earth through an auxiliary probe (H). The impedance of the auxiliary probe (H) should be as low as possible in order to inject a high test current. The impedance R_c can be decreased by using more probes in parallel. A higher injected current improves the immunity against spurious earth currents. The voltage drop is measured by auxiliary potential probe (S) and (ES) terminal. The selective currents I_{f1-4} is measured through the earthing electrodes Z_{sel1-4} selected by the user. The selected earth impedance Z_{sel1-4} is determined from the voltage/current (external current clamp – I_{f1-4}) ratio.

Total earth impedance is measured:

$$\frac{1}{Z_{tot}} = \sum_{i=1}^4 \frac{1}{Z_{sel_i}} = \left[\frac{1}{\Omega} \right] \quad Z_{sel_i} = \frac{U_{S-ES} [V]}{I_{f_i}} = [\Omega] \quad \text{where: } i = [1..4]$$

where:

- Z_{tot} Total selected earth impedance
- Z_{sel1-4} Selected earth impedance
- R_c Impedance of auxiliary current probe (H)
- R_p Impedance of auxiliary potential probe (S)
- I_e Injected test current
- I_{f1-4} Measured current with Flex clamp
- U_{S-ES} Test voltage between S and ES terminal
- f_{set} Test frequency

Refer to **Appendix C – Functionality and placing of test probes** for more information how to place the earth auxiliary current (H) and potential probe (S).

Test can be started from the Selective (Flex Clamps 1-4) measurement window. Before carrying out a test the following parameters (Test Mode, Test Frequency, Number of turns F1 - F4 and Limit (Z_{tot}) can be edited.

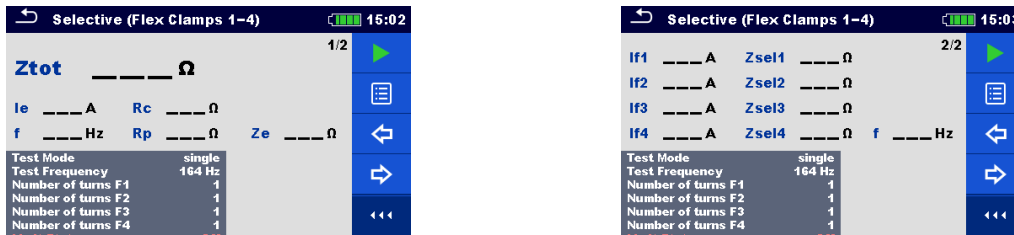

Figure 11.26: Selective (Flex Clamps 1-4) measurement menu

Test parameters for Selective (Flex Clamps 1-4):

Test Mode	Set test mode: [single, sweep].
Test Frequency*	Set test frequency: [55 Hz, 82 Hz, 164 Hz, 329 Hz, 659 Hz, 1.31 kHz, 1.50 kHz].
Number of turns F1	Set the number of turns for Flex 1 input terminal: [1, 2, 3, 4, 5, 6].
Number of turns F2	Set the number of turns for Flex 2 input terminal: [1, 2, 3, 4, 5, 6].
Number of turns F3	Set the number of turns for Flex 3 input terminal: [1, 2, 3, 4, 5, 6].
Number of turns F4	Set the number of turns for Flex 4 input terminal: [1, 2, 3, 4, 5, 6].
Limit (Z_{tot})	Limit value selection: [OFF, 0.1 Ω – 5.00 k Ω].

*single test mode only.

Selective (Flex Clamps 1-4) Measurement procedure:

- Select the Selective (Flex Clamps 1-4) measurement function.
- Set the test parameters (mode, frequency, number of turns and limit).
- Connect the test leads and flex clamps to the instrument and to the test object.
- Press the Run key to start the measurement.
- Wait until the test result is displayed on the screen.
- Press the cursor keys to toggle between graph view and multiple result views.
- Save results (optional).

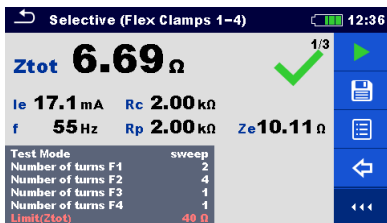

Figure 11.27: Example of Selective (Flex Clamps 1-4) measurement result - Z_{tot}

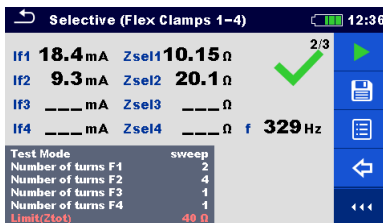

Figure 11.28: Example of Selective Flex Clamps 1-4) measurement result – Z_{sel1-4}

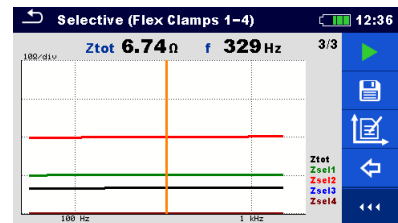

Figure 11.29: Example of Selective Flex Clamps 1-4) measurement graph view

Notes:

- Consider displayed warnings when starting the measurement!
- High noise currents and voltages in earth could influence the measurement results. The tester displays the “noise” warning in this case.
- When measuring at high frequencies use the guard terminal and shielded cable (H).

Notes (Probes):

- High impedance of S and H probes could influence the measurement results. In this case, “Rp” and “Rc” warnings are displayed.
- Probes must be placed at a sufficient distance from the measured object.

Notes (Flex):

- When using only one, two or three flex clamps, always connect one clamp to F1 terminal (synchronization port).
- Make sure that the arrow marked on the clamp coupling points toward the correct orientation for correct phase measurement.
- Make sure that the number of turns is correctly entered in the test parameters window



11.1.8 Passive (Flex Clamps) Measurement

The passive measuring method is using the “Inductive current” or grounding wire current I_{gw} flowing in the earthing system to determine the selected earth resistances of individual earthing points. The measurement method is using only one auxiliary potential probe (S).

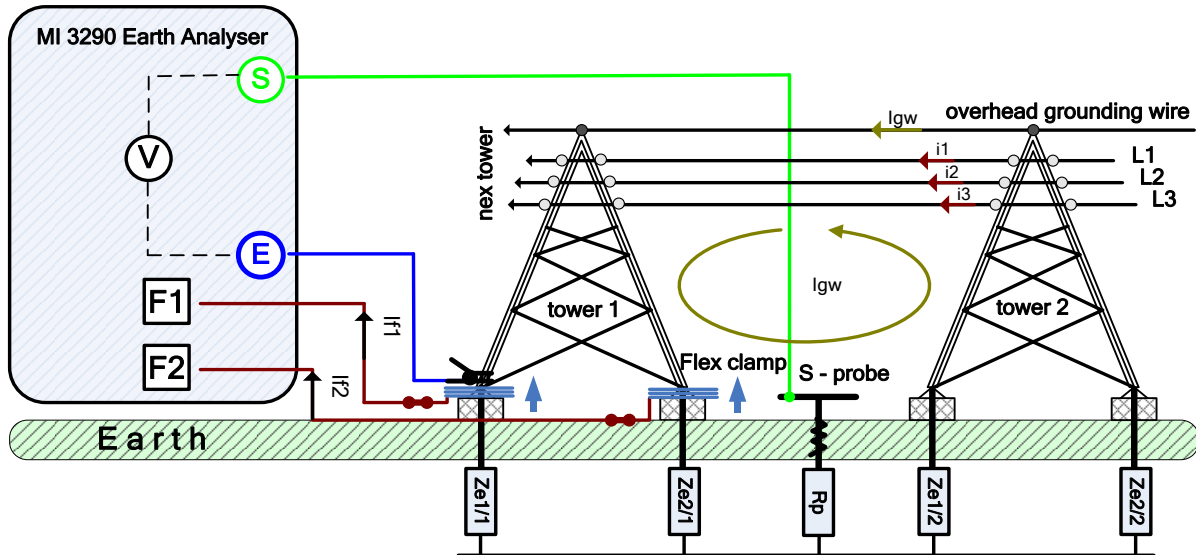

Figure 11.30: Passive (Flex Clamps) example

During the measurement a “inductive current” - I_{gw} is flowing into the earth through $Z_{sel1/1}$, $Z_{sel2/1}$, $Z_{sel1/2}$ and $Z_{sel2/2}$. A higher noise current improves the overall measuring result. The voltage drop is measured by auxiliary potential probe (S). The selective currents I_{f1-4} is measured through the earthing electrode $Z_{sel1-4/1}$ selected by the user. The selected earth impedance $Z_{sel1-4/1}$ is determined from the voltage/current (external current clamp – I_{f1-4}) ratio. Total earth impedance is measured:

$$\frac{1}{Z_{tot}} = \sum_{i=1}^4 \frac{1}{Z_{sel_i/1}} = \left[\frac{1}{\Omega} \right] \quad Z_{sel_i/1} = \frac{U_{S-E} [V]}{I_{f_i}} = [\Omega] \quad \text{where: } i = [1..4]$$

where:

- Z_{tot} Total selected earth impedance
- $Z_{sel1-4/1}$ Selected Earth impedance
- I_{gw} Inductive current or grounding wire current
- I_{f1-4} Measured current with Flex clamp
- U_{S-E} Test voltage between S and E terminal

Note:

- “Inductive current” - I_{gw} in the example is actually an inductive coupling current between wires L1 (i_1), L2 (i_2), L3 (i_3) and overhead grounding wire loop. The current has the same frequency as the L1, L2 and L3 current (usually power frequencies 50 Hz or 60 Hz).

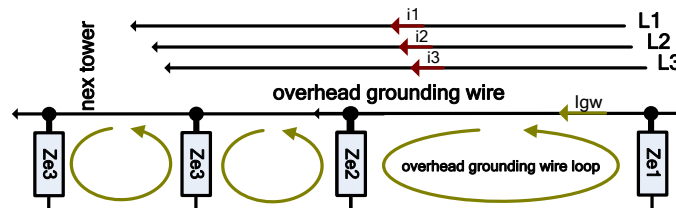

Figure 11.31: Substitute circuit for Passive (Flex Clamps) measurement

Test can be started from the Passive (Flex Clamps) measurement window. Before carrying out a test the following parameters (Number of turns F1 - F4 and Limit (Ztot)) can be edited.



Figure 11.32: Passive (Flex Clamps) measurement menu

Test parameters for Passive (Flex Clamps):

Number of turns F1	Set the number of turns for Flex 1 input terminal: [1, 2, 3, 4, 5, 6].
Number of turns F2	Set the number of turns for Flex 2 input terminal: [1, 2, 3, 4, 5, 6].
Number of turns F3	Set the number of turns for Flex 3 input terminal: [1, 2, 3, 4, 5, 6].
Number of turns F4	Set the number of turns for Flex 4 input terminal: [1, 2, 3, 4, 5, 6].
Limit (Ztot)	Limit value selection: [OFF, 0.1 Ω – 5.00 k Ω].

Passive (Flex Clamps) Measurement procedure:

- Select the Passive (Flex Clamps) measurement function.
- Set the test parameters (number of turns and limit).
- Connect the test leads and flex clamps to the instrument and to the test object.
- Press the Run key to start the measurement.
- Wait until the test result is displayed on the screen.
- Press the Run key again to stop the measurement.
- Press the cursor keys to toggle between multiple result views (optional).
- Save results (optional).

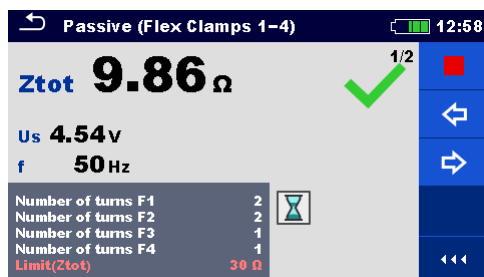

Figure 11.33: Example of Passive (Flex Clamps) measurement result - Z_{tot}

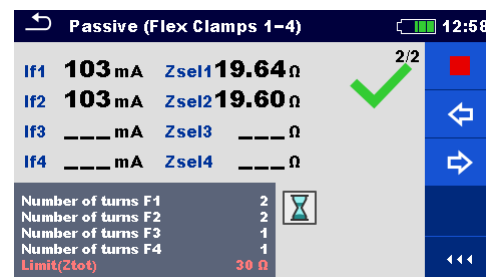

Figure 11.34: Example of Passive (Flex Clamps) measurement result – Z_{sel1-4}

Notes:

- Consider displayed warnings when starting the measurement!
- High noise currents and voltages in earth could influence the measurement results. The tester displays the “noise” warning in this case.

Note (Probe):

- Probes must be placed at a sufficient distance from the measured object.

Notes (Flex):

- When using only one, two or three flex clamps, always connect one clamp to F1 terminal (synchronization port).
- Make sure that the arrow marked on the clamp coupling points toward the correct orientation for correct phase measurement.
- Make sure that the number of turns is correctly entered in the test parameters window.

11.2 Specific Earth Resistance Measurements [ρ]

The measurement is carried out in order to assure more accurate calculation of earthing systems e.g. for high-voltage distribution towers, large industrial plants, lightning systems etc. AC test voltage should be used for the measurement. DC test voltage is not suitable because of possible electro-chemical processes in the measured ground material. Specific Earth Resistance value is expressed in Ωm or Ωft , its absolute value depends on structure of the ground material.

Specific Earth Resistance	Measurement	Test Mode	Distance	Limit	Filter	Test Voltage
ρ	Wenner Method	single	m / ft	yes	FFT	20 / 40 V
	Schlumberger Method	single	m / ft	yes	FFT	20 / 40 V

Table 11.35: Available Specific Earth Resistance measurements in the MI 3290

11.2.1 General on specific earth

What is Specific Earth Resistance?

It is the resistance of ground material shaped as a cube $1 \times 1 \times 1 \text{ m}$, where the measurement electrodes are placed at the opposite sides of the cube, see the figure below.

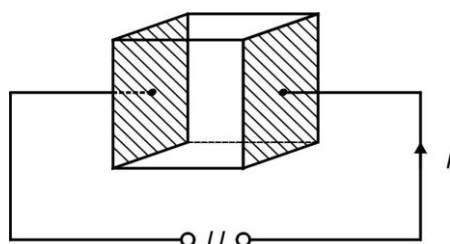

Figure 11.36: Presentation of Specific Earth Resistance

The table below represents indicative values of Specific Earth Resistances for a few typical ground materials.

Type of ground material	Specific Earth Resistance in Ωm	Specific Earth Resistance in Ωft
sea water	0,5	1,6
lake or river water	10 – 100	32,8 – 328
ploughed earth	90 – 150	295 – 492
concrete	150 – 500	492 – 1640
wet gravel	200 – 400	656 – 1312
fine dry sand	500	1640
lime	500 – 1000	1640 – 3280
dry gravel	1000 – 2000	3280 – 6562
stony ground	100 – 3000	328 – 9842



11.2.2 Wenner method Measurement

Place the four earth probes on a straight line, at a distance **a** from one another and at a depth **b** < **a/20**. Distance **a** must be between 0,1 m and 29,9 m. Connect the cables to the probes, then to terminals H, S, ES, and E.

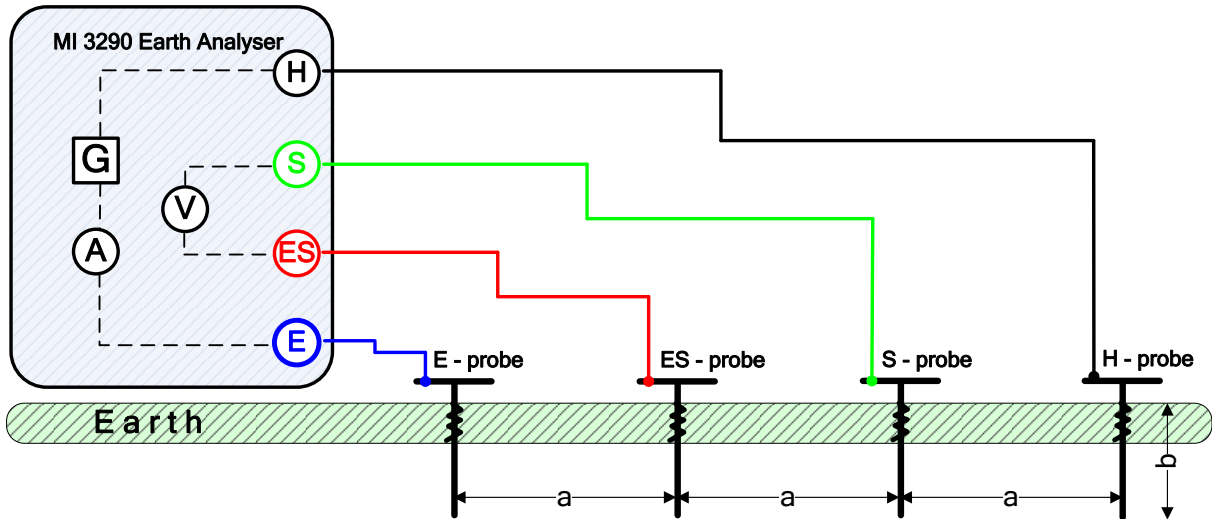

Figure 11.37: Wenner method example

Wenner method with equal distances between test probes:

$$b < \frac{a}{20}$$

$$\rho_{wenner} = 2 \cdot \pi \cdot a \cdot R_e = [\Omega m]$$

where:

- R_e Measured earth resistance in 4-pole method
- a Distance between earth probes
- b Depth of earth probes
- π Number π is a mathematical constant (3.14159)

Test can be started from the Wenner method measurement window. Before carrying out a test the following parameters (Test Voltage, Distance a and Limit (ρ)) can be edited.

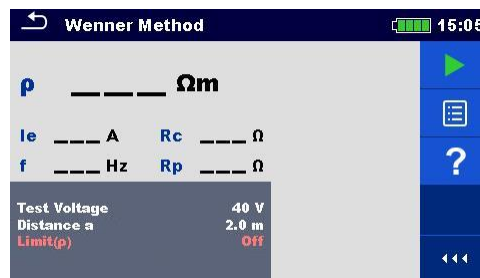

Figure 11.38: Wenner method measurement menu

Test parameters for Wenner method:

Test Voltage Set test voltage: [20 V or 40 V].

Distance a Set the distance between earth probes: [0.1 m – 49.9 m] or [1 ft – 200 ft]

Limit (ρ) Limit value selection: [OFF, 0.1 Ω m – 15 k Ω m].

Limit value selection: [OFF, 1 Ω ft – 40 k Ω ft].

Wenner method Measurement procedure:

- Select the Wenner method measurement function.
- Set the test parameters (voltage, distance and limit).
- Connect the test leads to the instrument and to the test object.
- Press the Run key to start the measurement.
- Wait until the test result is displayed on the screen.
- Save results (optional).



Figure 11.39: Example of Wenner method measurement result

Notes:

- Consider displayed warnings when starting the measurement!
- High noise currents and voltages in earth could influence the measurement results. The tester displays the “noise” warning in this case.

Notes (Probes):

- High impedance of S and H probes could influence the measurement results. In this case, “Rp” and “Rc” warnings are displayed. There is no pass / fail indication in this case.
- Probes must be placed at a sufficient distance from the measured object.



11.2.3 Schlumberger method Measurement

Place the two earth probes (ES and S) at a distance **d** from one another and place the second two earth probes (E and H) at a distance **a** from ES and S probes. All probes must be placed on a straight line and to a depth of **b**, considering the condition $b \ll a, d$. Distance **d** must be between 0,1 m and 29,9 m and the distance **a** must be $a > 2 \cdot d$. Connect the cables to the probes, then to terminals H, S, ES, and E.

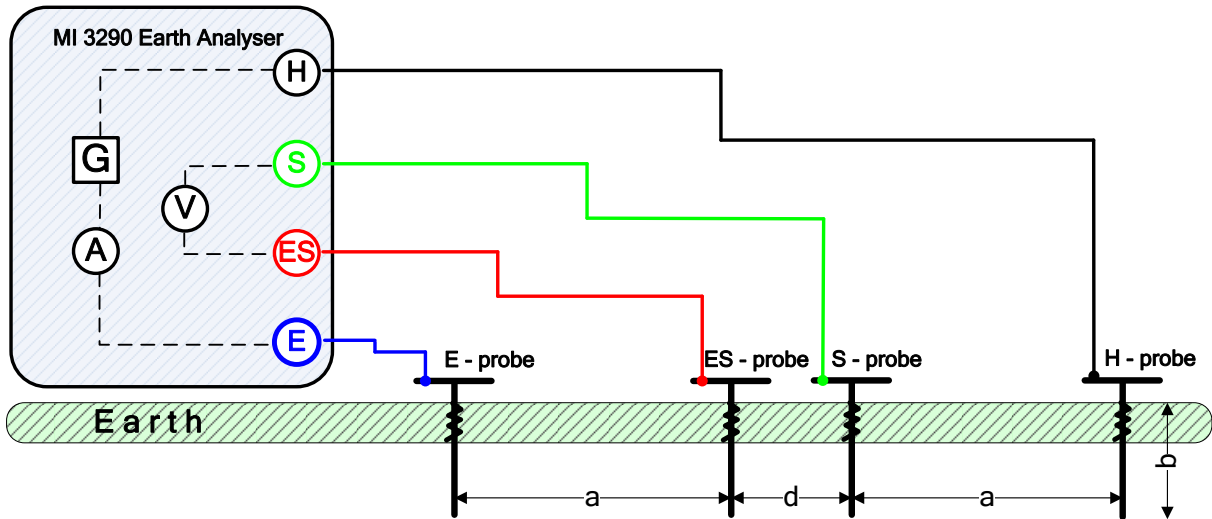

Figure 11.40: Schlumberger method example

Schlumberger method with unequal distances between test probes:

$$b \ll a \cdot d \quad a > 2 \cdot d$$

$$\rho_{schlumberger} = \frac{\pi \cdot a \cdot (a + d) \cdot R_e}{d} = [\Omega m]$$

where:

- R_e Measured earth resistance in 4-pole method
- a Distance between earth probes (E, ES) and (H, S)
- d Distance between earth probes (S, ES)
- b Depth of earth probes
- π Number π is a mathematical constant (3.14159)

Test can be started from the Schlumberger method measurement window. Before carrying out a test the following parameters (Test Voltage, Distance a, Distance d and Limit (ρ)) can be edited.

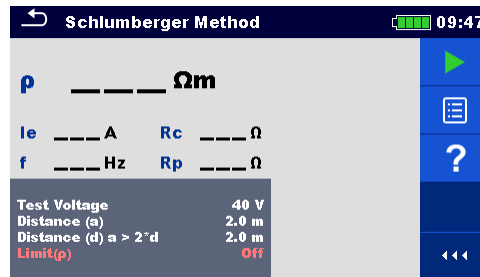

Figure 11.41: Schlumberger method measurement menu

Test parameters for Schlumberger method:

Test Voltage	Set test voltage: [20 V or 40 V].
Distance a	Set the distance between earth electrodes: [0.1 – 49.9 m] or [1 – 200 ft]
Distance d	Set the distance between earth electrodes: [0.1 – 49.9 m] or [1 – 200 ft]
Limit (ρ)	Limit value selection: [OFF, 0.1 Ω m – 15 k Ω m]. Limit value selection: [OFF, 1 Ω ft – 40 k Ω ft].

Schlumberger method Measurement procedure:

- Select the Schlumberger method measurement function.
- Set the test parameters (voltage, distances and limit).
- Connect the test leads to the instrument and to the test object.
- Press the Run key to start the measurement.
- Wait until the test result is displayed on the screen.
- Save results (optional).

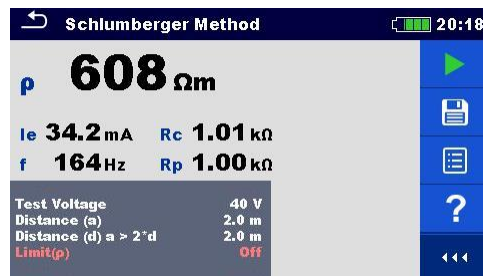

Figure 11.42: Example of Schlumberger method measurement result

Notes:

- Consider displayed warnings when starting the measurement!
- High noise currents and voltages in earth could influence the measurement results. The tester displays the “noise” warning in this case.

Notes (Probes):

- High impedance of S and H probes could influence the measurement results. In this case, “Rp” and “Rc” warnings are displayed. There is no pass / fail indication in this case.
- Probes must be placed at a sufficient distance from the measured object.

11.3 Impulse Impedance [Zp]

The impulse impedance of an earthing system is a useful parameter, to predict the behaviour in transient conditions, as it provides a direct relationship between the peak potential rise and the peak current rise.



11.3.1 Impulse Measurement

The three pole method or the fall of potential method test configurations are typically used for this type of tester. The measurement is performed with two earthing probes. The drawback if using three wires is that the contact resistance of E terminal is added to the result.

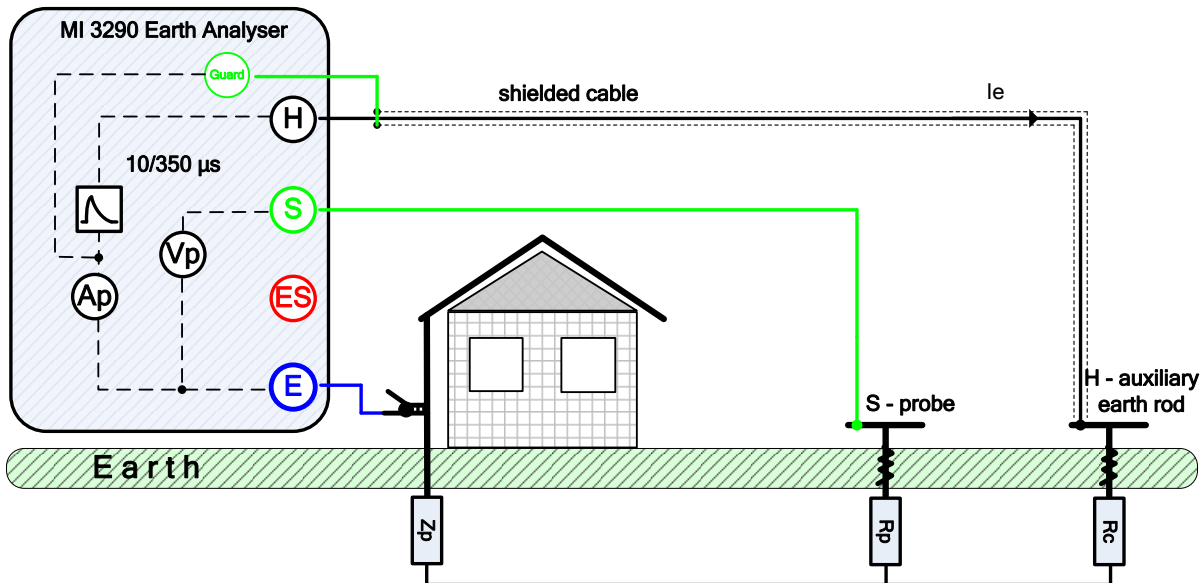
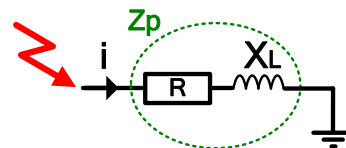

Figure 11.43: Impulse Measurement example

During the measurement a current impulse (10/350 μs) is injected into the earth through an auxiliary probe (H). The impedance of the auxiliary probe (H) should be as low as possible in order to inject a high test current. The impedance Rc can be decreased by using more probes in parallel. A higher injected current impulse improves the immunity against spurious earth currents. The voltage peak is measured by potential probe (S). The impulse impedance Zp is determined from the voltage peak /current peak ratio.

In the example following impulse impedance is measured:

$$Z_p = \frac{U_{peak}}{I_{peak}} - Z_{in}$$



where:

- Z_p Impulse impedance
- Z_{in} Internal impedance of the instrument (typ. 1 Ω)
- U_{peak} Peak voltage
- I_{peak} Peak current

Note:

The current probe Rc and potential probe Rp are measured using 3-Pole measurement at a fix frequency 3.29 kHz @ 40 Vac open-terminal test voltage.

Test can be started from the Impulse measurement window. Before carrying out a test the parameter limit (Zp) can be edited.

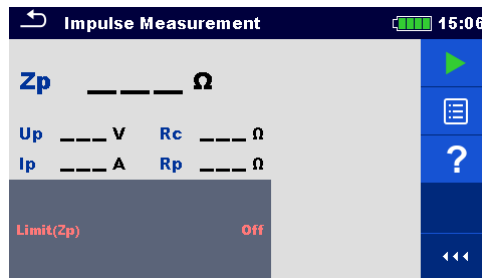

Figure 11.44: Impulse measurement menu

Test parameters for Impulse:

Limit (Zp) Limit value selection (OFF, 1 Ω – 100 Ω).

Impulse Measurement procedure:

- Select the impulse Measurement function.
- Set the test parameter (limit).
- Connect the test leads to the instrument and to the test object.
- Press the Run key to start the measurement.
- Wait until the test result is displayed on the screen.
- Save results (optional).

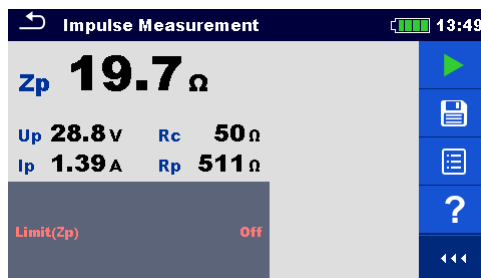

Figure 11.45: Example of Impulse measurement result

Notes:

- Consider displayed warnings when starting the measurement!
- High noise currents and voltages in earth could influence the measurement results. The tester displays the “noise” warning in this case.

Notes (Probes):

- High impedance of S and H probes could influence the measurement results. In this case, “Rp” and “Rc” warnings are displayed. There is no pass / fail indication in this case.
- Probes must be placed at sufficient distance from the measured object.

11.4 DC Resistance [R]

DC Resistance	Measurement	Test Mode	Test Method	Limit	Filter	Test Current
R	Ω - Meter (200mA)	single	2-wire	yes	DC	200 mA
	Ω - Meter (7mA)	cont.	2-wire	yes	DC	7 mA

Table 11.46: Available DC Resistance measurements in the MI 3290



11.4.1 Ω - Meter (200 mA) Measurement

The resistance measurement is performed in order to assure that the protective measures against electric shock through earth bond connections are effective. The resistance measurement is performed with DC current of 200 mA.

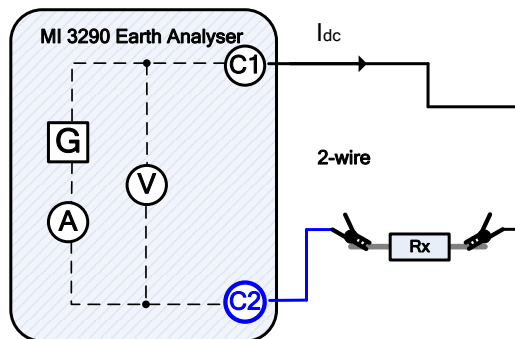

Figure 11.47: Ω - Meter (200 mA) example (2-wires)

In the example following resistance is measured:

$$R = \frac{U_{DC} [V]}{I_{DC} [A]} = [\Omega]$$

where:

R Resistance

I_{dc} Injected DC test current between C1 and C2 terminals

U_{dc} Measured DC voltage between C1 and C2 terminals

Test can be started from the Ω - Meter (200 mA) measurement window. Before carrying out a test the following parameter (Limit (R)) can be edited.

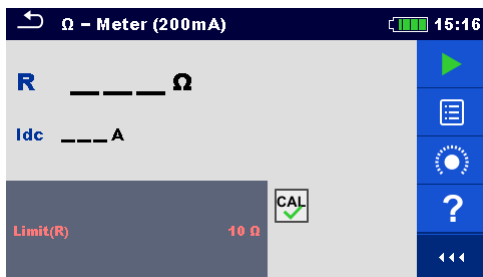

Figure 11.48: Ω - Meter (200 mA) measurement menu

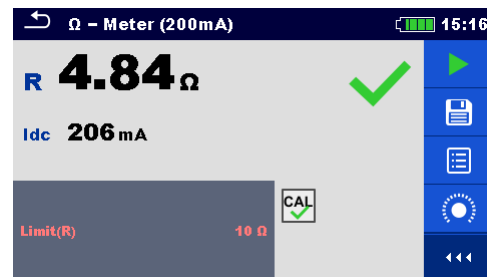

Figure 11.49: Example of Ω - Meter (200 mA) measurement result

Test parameters for Ω - Meter (200 mA):

Limit (R) Limit value selection: [OFF, 0.1 Ω – 40 Ω].

Ω - Meter (200 mA) measurement procedure:

- ❑ Select the Ω - Meter (200 mA) measurement function.
- ❑ Set the test parameter (limit).
- ❑ Connect the test leads to the instrument.
- ❑ Compensate the leads if using 2-wire test method (optional).
- ❑ Connect the test leads to the test object.
- ❑ Press the Run key to start the measurement.
- ❑ Wait until the test result is displayed on the screen.
- ❑ Save results (optional).

Note:

- ❑ Consider displayed warnings when starting the measurement!



11.4.2 Ω - Meter (7 mA) Measurement

In general, this function serves as standard Ω - meter with a low testing current. The measurement is performed continuously without polarity reversal. This function can also be applied for testing continuity of inductive components.

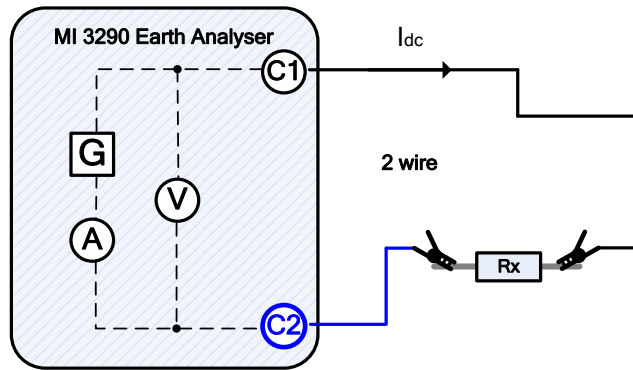

Figure 11.50: Ω - Meter (7 mA) example

In the example following resistance is measured:

$$R = \frac{U_{DC} [V]}{I_{DC} [A]} = [\Omega]$$

where:

R Resistance

I_{dc} Injected test current DC

U_{dc} Measured DC voltage between C1 and C2 terminals

Test can be started from the Ω - Meter measurement window. Before carrying out a test the following parameters (Sound and Limit (R)) can be edited.

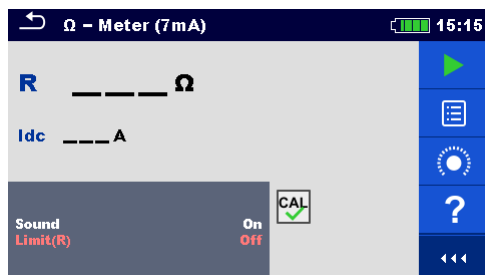

Figure 11.51: Ω - Meter (7 mA) measurement menu

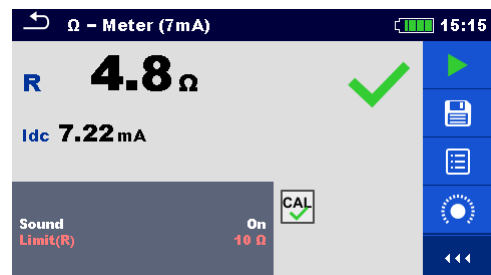

Figure 11.52: Example of Ω - Meter (7 mA) measurement result

Test parameters for Ω - Meter (7 mA):

Sound [On, Off]

Limit (R) Limit value selection: [OFF, 1 Ω – 15.0 kΩ].

Ω - Meter (7 mA) measurement procedure:

- Select the Ω - Meter (7 mA) measurement function.
- Set the test parameters (sound and limit).
- Connect the test leads to the instrument.
- Compensate the leads (optional).
- Connect the test leads to the test object.
- Press the Run key to start the measurement.
- Wait until the test result is displayed on the screen.
- Press the Run key to stop the measurement.
- Save results (optional).

Note:

- Consider displayed warnings when starting the measurement!

11.4.2.1 Compensation of test leads resistance

This chapter describes how to compensate test leads resistance in both continuity functions (Ω - Meter 200 mA and 7 mA). Compensation is required in 2-wire mode to eliminate the influence of test leads resistance and the internal resistances of the instrument on the measured resistance. The lead compensation is therefore a very important feature to obtain

correct result. Once compensation has been performed, the compensation icon  appears on the screen.



Circuits for compensating the resistance of test leads

Figure 11.53: Shorted test leads

Compensation of test leads resistance procedure:

- Select the Ω - Meter 200 mA or 7 mA function.
- Connect test cable to the instrument and short the test leads together see **Figure 11.53**.
- Press the  icon to compensate leads resistance.

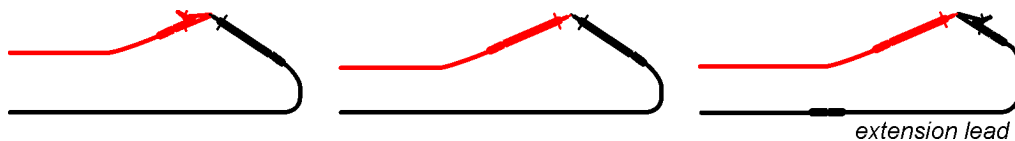
Notes:

- The limit value for lead compensation is 5 Ω .
- The lead compensation current is 200mA DC.

11.5 AC Impedance [Z]

An impedance vector consists of a real part (resistance, R) and an imaginary part (reactance, X) as shown in **Figure 11.54**.

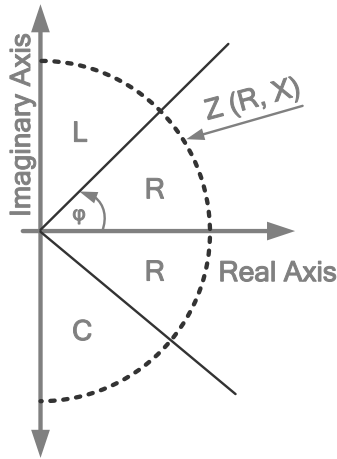

$$Z = R + jX = [\Omega]$$

where:

Z Impedance

R Real part of impedance (resistance)

jX Imaginary part of impedance (reactance)

φ Phase angle

Figure 11.54: A graphical representation of the complex impedance plane

11.5.1 Impedance Meter Measurement

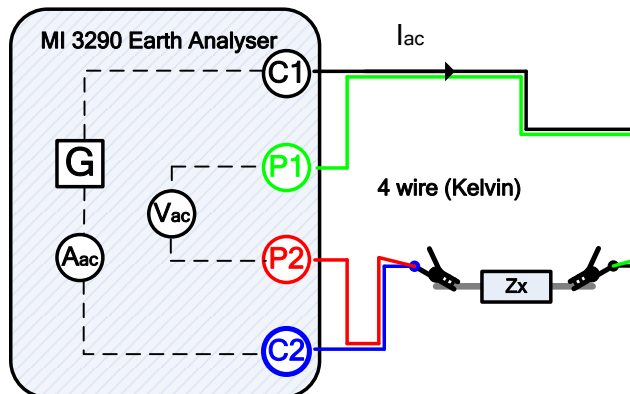

Figure 11.55: Impedance Meter example 4-wires

In the example following impedance is measured:

$$Z = \frac{U_{AC} [V]}{I_{AC} [A]} = [\Omega]$$

where:

Z Impedance

I_{ac} Injected AC test current between C1 and C2 terminals

U_{ac} Measured AC voltage between P1 and P2 terminals (4-wires)

Test can be started from the Impedance Meter measurement window. Before carrying out a test the following parameters (Test Mode, Test Frequency, Test Voltage and Limit (Z)) can be edited.

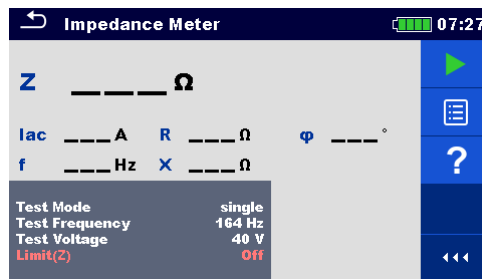

Figure 11.56: Impedance Meter measurement menu

Test parameters for Impedance Meter:

Test Mode	Set test mode: [single, sweep].
Test Frequency*	Set test frequency: [55 Hz, 82 Hz, 164 Hz, 329 Hz, 659 Hz, 1.31 kHz, 1.50 kHz, 2.63 kHz, 3.29 kHz, 6.59 kHz, 13.1 kHz, 15.0 kHz].
Test Voltage	Set test voltage: [20 V or 40 V].
Limit (Z)	Limit value selection: ([OFF, 1 Ω – 15.0 k Ω]).

*single test mode only.

Impedance Meter measurement procedure:

- Select the Impedance Meter measurement function.
- Set the test parameters (mode, voltage, frequency and limit).
- Connect the test leads to the instrument and to the test object.
- Press the Run key to start the measurement.
- Wait until the test result is displayed on the screen.
- Press the cursor keys to toggle between graph view and result view (optional).
- Save results (optional).

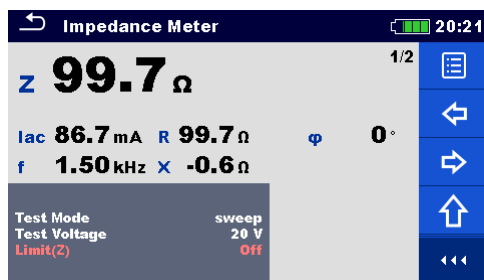

Figure 11.57: Example of Impedance Meter measurement result

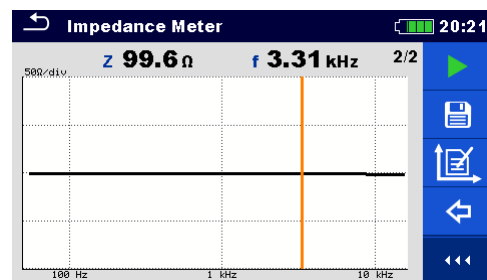

Figure 11.58: Example of Impedance Meter measurement graph view

Note:

- Consider displayed warnings when starting the measurement!

11.6 Earth Potential [Vp]

An earthing electrode / grid deployed into ground have a certain resistance, depending on its size, surface (oxides on the metal surface) and the soil resistivity around the electrode. The earthing resistance is not concentrated in one point but is distributed around the electrode. Correct earthing of exposed conductive parts assures that the voltage on them stays below dangerous level in case of a fault.

If a fault happens a fault current will flow through the earthing electrode. A typical voltage distribution occurs around the electrode (the “voltage funnel”). The largest part of the voltage drop is concentrated around the earth electrode. *Figure 11.59* shows how fault, step and contact voltages occur as a result of fault currents flowing through the earthing electrode / grid in the ground.

Fault currents close to power distribution objects (substations, distribution towers, plants) can be very high, up to 200 kA. This can result in dangerous step and contact voltages. If there are underground metal connections (intended or unknown) the voltage funnel can get atypical forms and high voltages can occur far from the point of failure. Therefore, the voltage distribution in case of a fault around these objects must be carefully analysed.

In the example below step and touch voltage are illustrated:

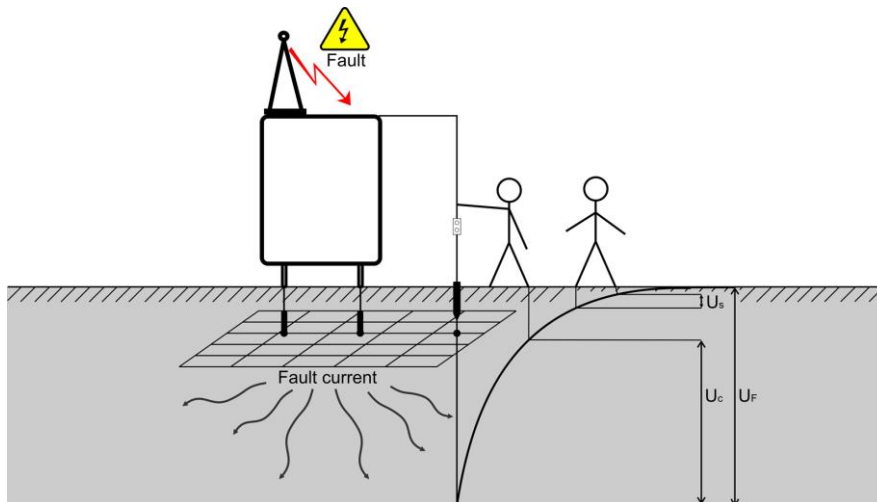

Figure 11.59: Dangerous voltages on a faulty earthing system

where:

- U_S Step Voltage in case of a fault current
- U_C Contact or Touch Voltage in case of a fault current
- U_F Fault voltage

Standard IEC 61140 defines following maximum allowed time / contact voltage relations:

Maximum time of exposure	Voltage
>5 s to ∞	$U_C \leq 50 \text{ VAC}$ or $\leq 120 \text{ VDC}$
< 0,4 s	$U_C \leq 115 \text{ VAC}$ or $\leq 180 \text{ VDC}$
< 0,2 s	$U_C \leq 200 \text{ VAC}$
< 0,04 s	$U_C \leq 250 \text{ VAC}$

Table 11.60: Maximum time durations vs fault voltage

For a longer exposure the touch voltages must stay below 50 V.



11.6.1 Potential Measurement

Local potential differences can be simply measured using 3 – pole wiring and setting up two distances R (total distance E - H), r (distance between E - S) and optional direction ϕ .

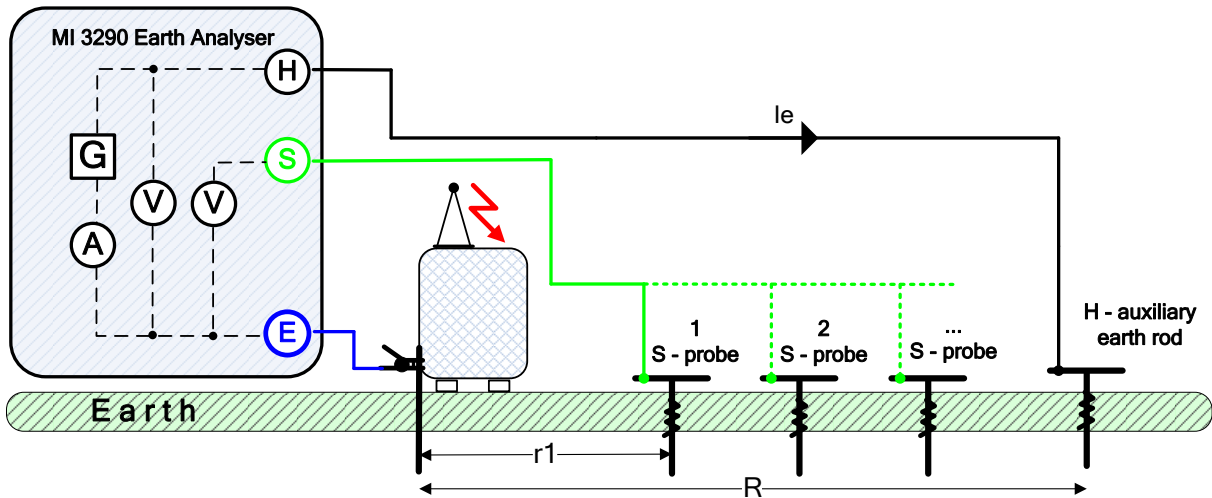

Figure 11.61: Potential example

In the example following potential ratio is measured:

$$V_P = 1 - \left(\frac{U_S [V]}{U_H [V]} \right)$$

where:

- V_P Potential ratio between S and H terminal (0 - 1)
- U_H Test voltage between H and E terminal
- U_S Test voltage between S and E terminal
- R Total distance between E and auxiliary earth rod H
- r Distance between E and S probe
- ϕ Direction of potential measurement or angle ($0^\circ - 360^\circ$)

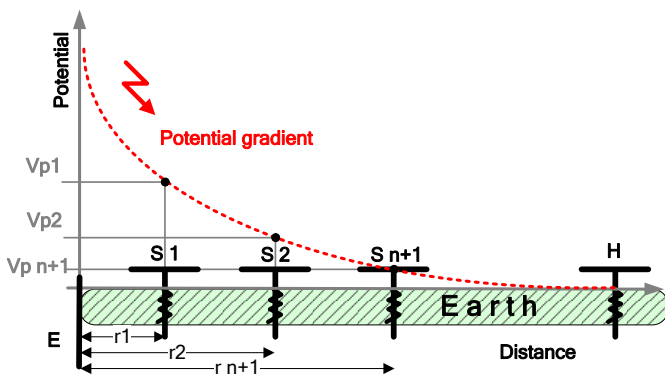

Figure 11.62: Potential gradient example (straight line)

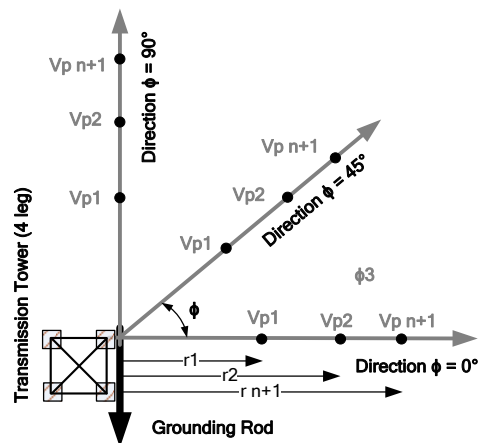

Figure 11.63: Potential gradient example (around the building)

Test can be started from the Potential measurement window. Before carrying out a test the following parameters (Test Frequency, Distance r , Distance R and Direction ϕ) can be edited.

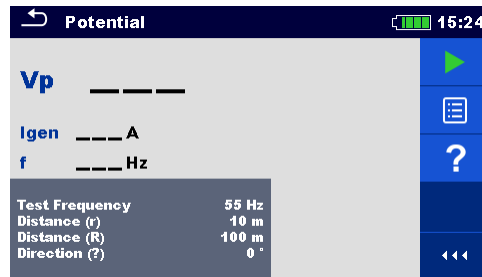

Figure 11.64: Potential ratio measurement menu

Test parameters for Potential ratio measurement:

Test	Set test frequency: [55 Hz, 82 Hz, 164 Hz, 329 Hz].
Frequency	
Distance r	Set distance between E – S: [1 m – 90 m].
Distance R	Set total distance between E – H: [10 m – 500 m].
Direction ϕ	Direction of potential measurement or angle: [0° – 360°]

Potential ratio measurement procedure:

- Select the Potential measurement function.
- Set the test parameters (frequency, distances r and R and direction).
- Connect the test leads to the instrument and to the test object.
- Press the Run key to start the measurement.
- Wait until the test result is displayed on the screen.
- Save results (optional).

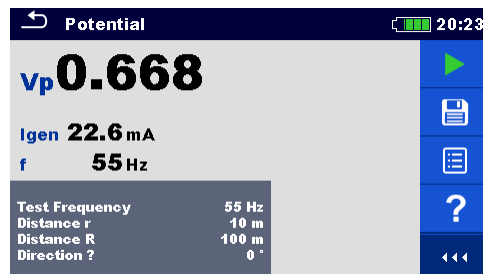

Figure 11.65: Example of potential ratio measurement result

Notes:

- Consider displayed warnings when starting the measurement!
- High noise currents and voltages in earth could influence the measurement results. The tester displays the “noise” warning in this case.



11.6.2 Step and Touch Voltages Theory

Step Voltage

The measurement is performed between two ground points at a distance of 1 m as shown on Figure. The metal plates (S2053) simulates the feet. The voltage between the probes is measured by a voltmeter (MI 3295M) with an internal resistance of 1 k Ω that simulates the body resistance.

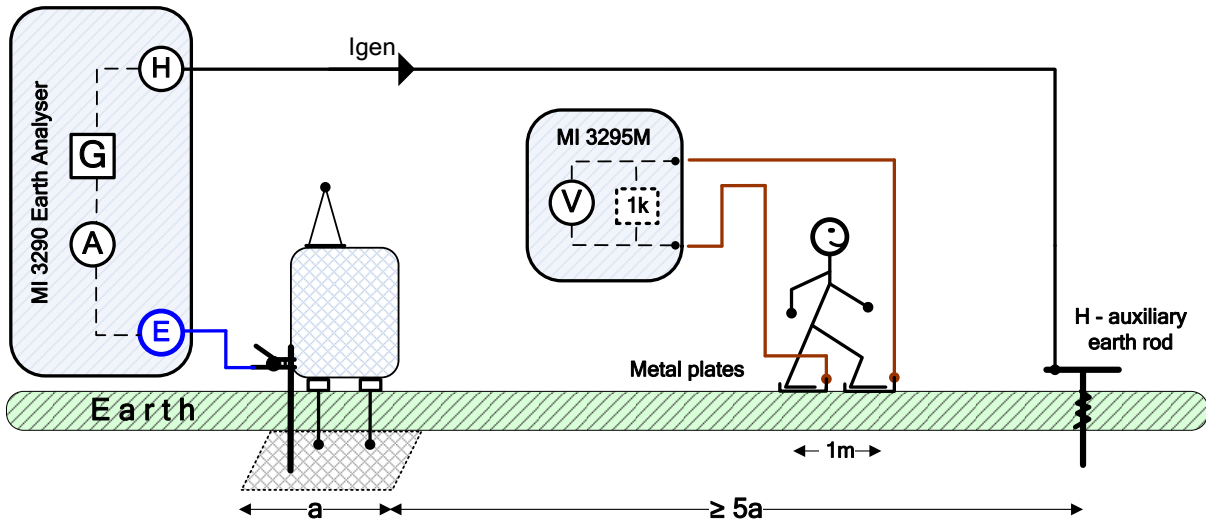

Figure 11.66: Step Voltage example

Touch Voltage

The measurement is performed between an earthed accessible metal part and ground 1 m apart as shown on Figure. The voltage between the metal plates (S2053) is measured by a voltmeter (MI 3295M) with an internal resistance of 1k Ω that simulates the body resistance.

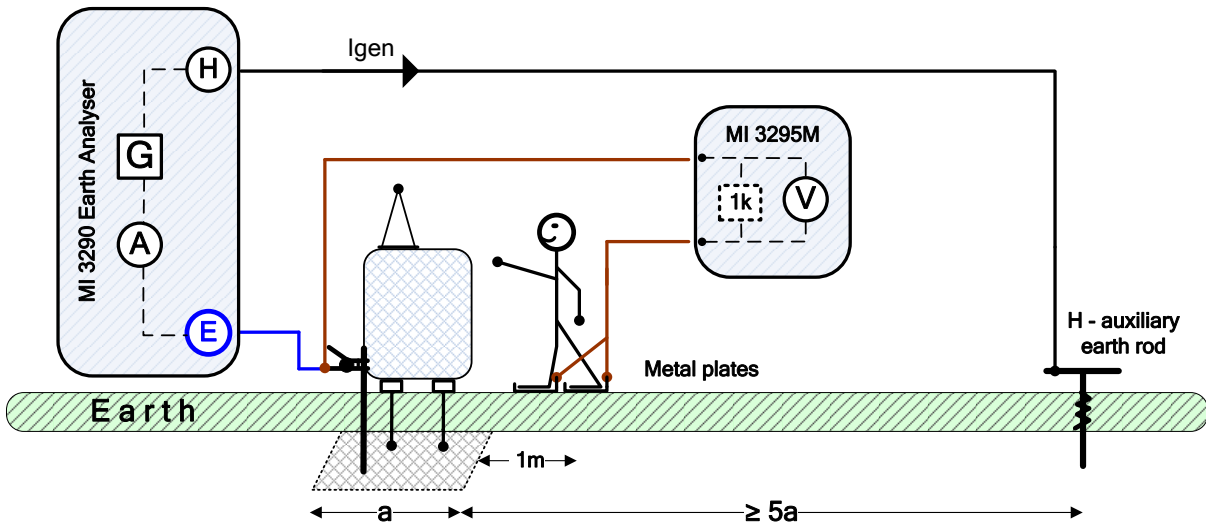

Figure 11.67: Touch Voltage example

S&T Current Source

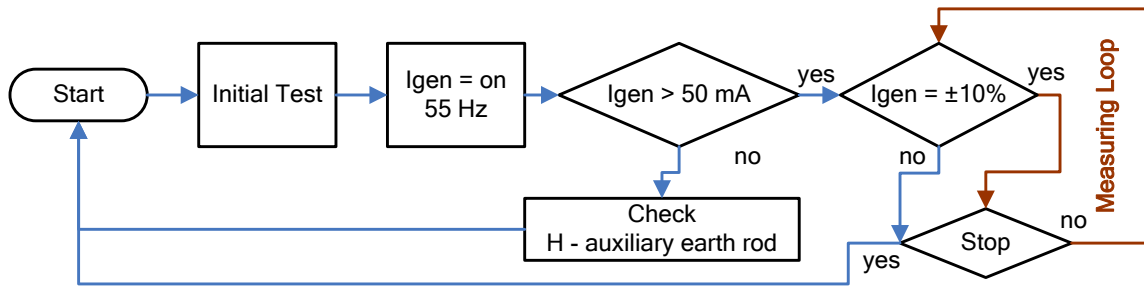

Figure 11.68: S&T Current source flow chart

During the measurement a sinusoidal current (55 Hz) I_{gen} is injected into the earth through an auxiliary probe (H). The resistance of the auxiliary probe (H) should be as low as possible in order to inject a high test current. The resistance R_c can be decreased by using more probes in parallel. A higher injected current improves the immunity against spurious earth currents. The voltage drop is measured with the help of MI 3295M (high sensitive 55 Hz V - meter). As the test current is usually only a small fraction of the highest fault current, the measured voltages must be up scaled according to following equation:

$$U_{s,t} = U_m (\text{MI3295M}) \cdot \frac{I_{fault}}{I_{gen} (\text{MI3290})}$$

where:

- $U_{s,t}$ Calculated Step or Touch Voltage in case of an fault current
- U_m Test voltage drop MI 3295M V-meter
- I_{fault} Set fault current voltage (maximal earth current in case of a fault)
- I_{gen} Test current injected between H (C1) and E (C2) terminal

Test can be started from the S&T Current Source window.

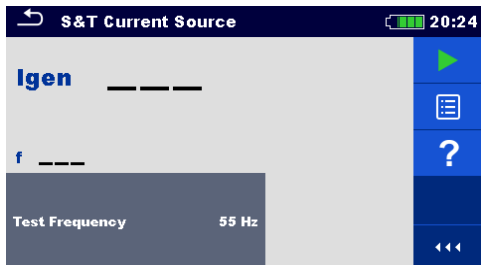

Figure 11.69: S&T Current Source menu

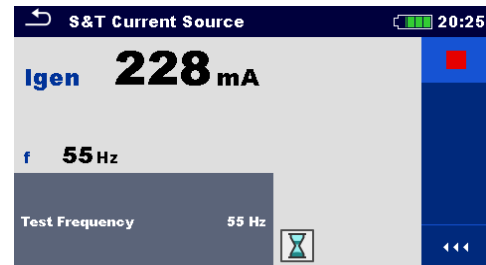

Figure 11.70: Example of S&T Current Source menu result

S&T Current Source Measurement procedure:

- Select the S&T Current Source.
- Connect the test leads to the instrument and to the test object.
- Press the Run key to start the measurement.
- Wait until the test result is displayed on the screen.
- Press the Run key again to stop the measurement
- Save results (optional).

Notes:

- Consider displayed warnings when starting the measurement!
- MI 3290 is only a current source! For the voltage measurement U_m and for the step, touch calculation the user must use the MI 3295M instrument.

11.7 Pylon Ground Wire Test (PGWT)



11.7.1 PGWT Measurement

The PGWT measurement is performed to check the overhead grounding wire connection.

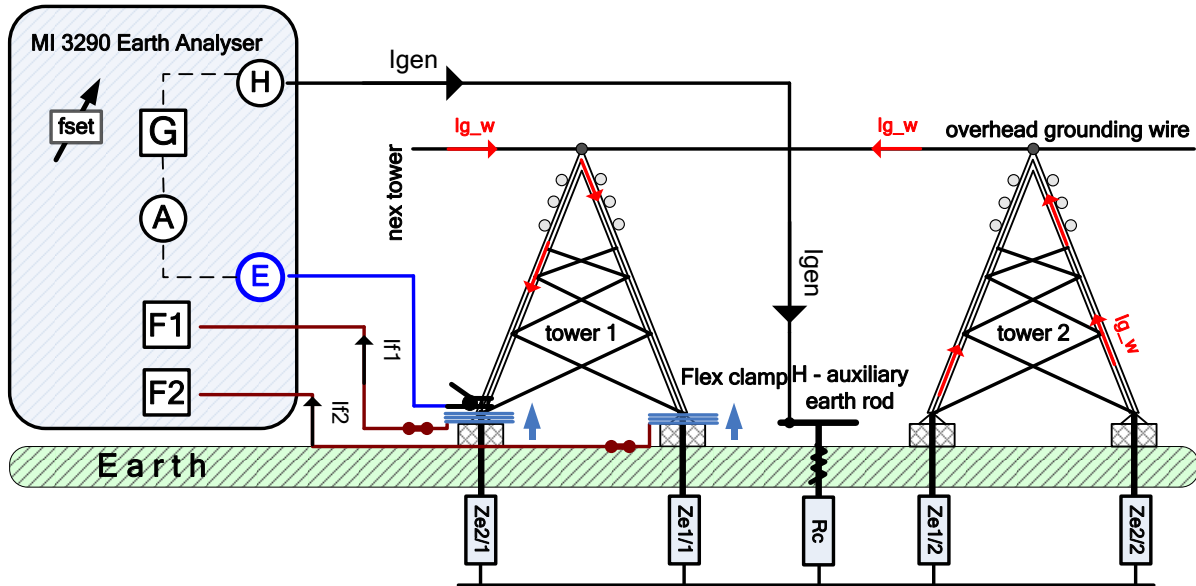

Figure 11.71: Pylon Ground Wire Test (PGWT) example

During the measurement a sinusoidal current I_{gen} is injected into the earth through an auxiliary probe (H). The resistance of the auxiliary probe (H) should be as low as possible in order to inject a high test current. The resistance R_c can be decreased by using more probes in parallel. A higher injected current improves the immunity against spurious earth currents.

In the example following current I_{g_w} is measured according to following equation:

$$I_{g_w} = I_{gen} [mA] - I_{f_sum} [mA] = [mA]$$

$$I_{f_sum} = I_{f1} [mA] + I_{f2} [mA] = [mA]$$

where:

- I_{g_w} Overhead ground wire current
- I_{gen} Generator current (injected test current)
- I_{f_sum} Total flex clamp current

Test can be started from the Pylon Ground Wire Test window. Before carrying out a test the following parameters (Test Mode, Frequency and Number of turns F1 – F4) can be edited.

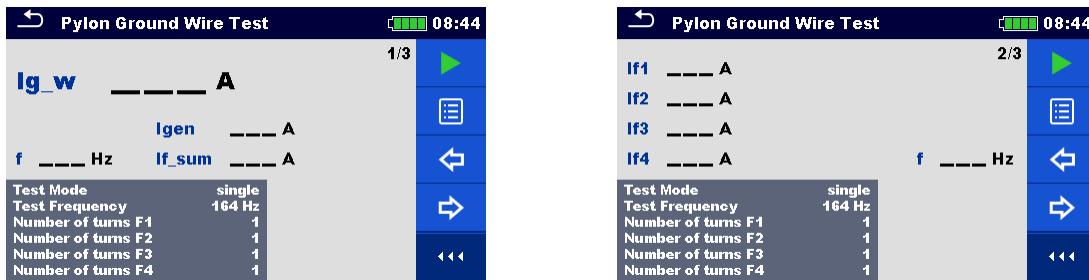

Figure 11.72: Pylon Ground Wire Test menu

Test parameters for Pylon Ground Wire Test:

Test Mode	Set test mode: [single, sweep].
Test Frequency	Set test frequency: [55 Hz, 82 Hz, 164 Hz, 329 Hz, 659 Hz, 1.31 kHz, 1.50 kHz].
Number of turns F1	Set the number of turns for Flex 1 input terminal: [1, 2, 3, 4, 5, 6].
Number of turns F2	Set the number of turns for Flex 2 input terminal: [1, 2, 3, 4, 5, 6].
Number of turns F3	Set the number of turns for Flex 3 input terminal: [1, 2, 3, 4, 5, 6].
Number of turns F4	Set the number of turns for Flex 4 input terminal: [1, 2, 3, 4, 5, 6].

Pylon Ground Wire Test (PGWT) measurement procedure:

- Select the Pylon Ground Wire Test function.
- Set the test parameters (mode, frequency, number of turns 1-4).
- Connect the test leads and flex clamps to the instrument and to the test object.
- Press the Run key to start the measurement.
- Wait until the test result is displayed on the screen.
- Press the cursor keys to toggle between graph view and multiple result views (optional).
- Save results (optional).

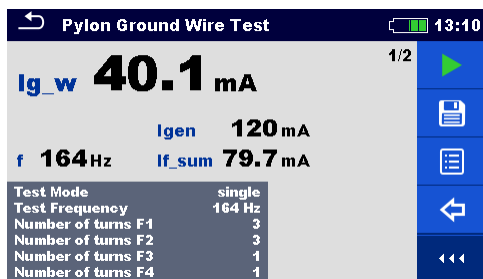

Figure 11.73: Example of Pylon Ground Wire test result – I_{g_w}

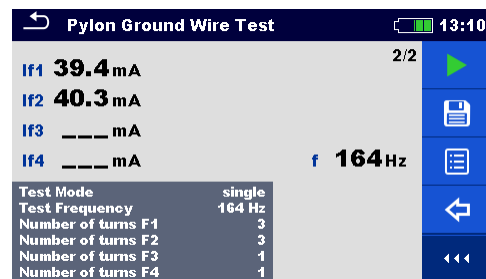

Figure 11.74: Example of Pylon Ground Wire Test result – $I_{f(1-4)}$

Notes:

- Consider displayed warnings when starting the measurement!
- High noise currents and voltages in earth could influence the measurement results. The tester displays the “noise” warning in this case.

Note (Probes):

- Probes must be placed at a sufficient distance from the measured object.

Notes (Flex):

- When using only one, two or three flex clamps, always connect one clamp to F1 terminal (synchronization port).
- Make sure that the arrow marked on the clamp coupling points toward the correct orientation for correct phase measurement.
- Make sure that the number of turns is correctly entered in the test parameters window.

11.8 Current [I]

Current	Measurement	Test Mode	Nominal frequency	Filter	Max. Measuring range
I _c , I _{f1} , I _{f2} , I _{f3} , I _{f4}	Iron Clamp Meter RMS	cont.	45 Hz – 1,5 kHz	RMS	7,99 A
	Flex Clamps Meter RMS	cont.	45 Hz – 1,5 kHz	RMS	49,9 A (1 turn)

Table 11.75: Available Current RMS measurements in the MI 3290

Iron Clamp Meter RMS

This function is intended for measurement of AC currents (leakage currents, loads currents, noise currents) using iron current clamp.

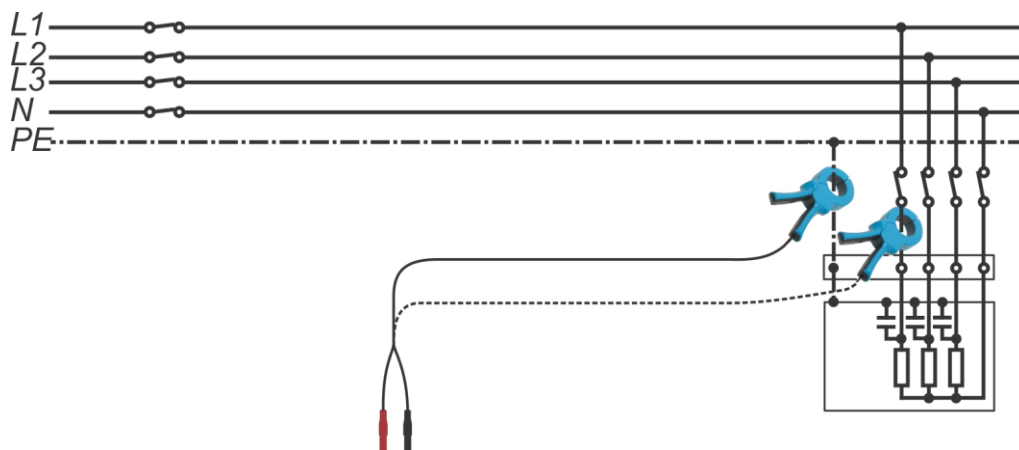

Figure 11.76: Iron Clamp Meter RMS example

Flex Clamp Meter RMS

This function is intended for measurement of AC currents (leakage currents, loads currents, inductive currents) using flex clamps. Wrap the measured object with the measuring clamp.

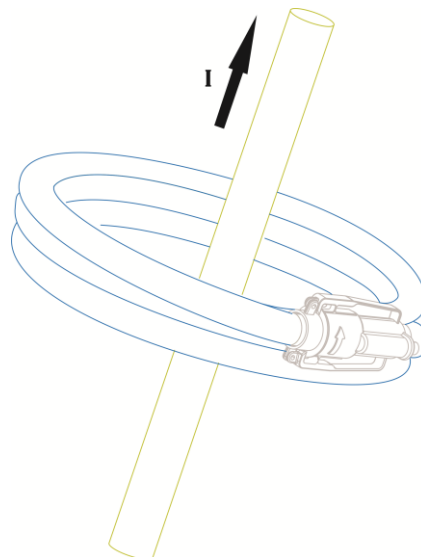

Figure 11.77: Flex Clamps Meter RMS example



11.8.1 Iron Clamp Meter RMS Measurement

Test can be started from the Iron Clamp Meter RMS measurement window. Before carrying out a test the following parameters (Measurement Clamp Type and Limit (Ic)) can be edited.

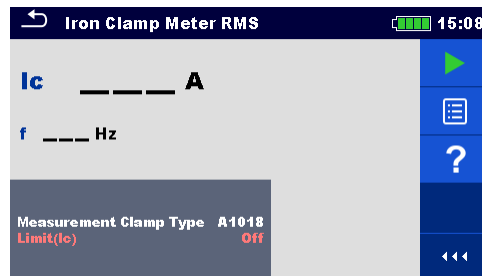

Figure 11.78: Iron Clamp Meter RMS measurement menu

Test parameters for Iron Clamp Meter RMS:

Measurement Set clamp type: [A1018].

Clamp type

Limit (Ic) Limit value selection: [OFF, 10 mA – 9.00 A].

Iron Clamp Meter RMS measurement procedure:

- Select the Iron Clamp Meter RMS measurement function.
- Set the test parameter (clamp type and limit).
- Connect the clamp to the instrument and to the test object.
- Press the Run key to start the measurement.
- Wait until the test result is displayed on the screen.
- Press the Run key to stop the measurement.
- Save results (optional).

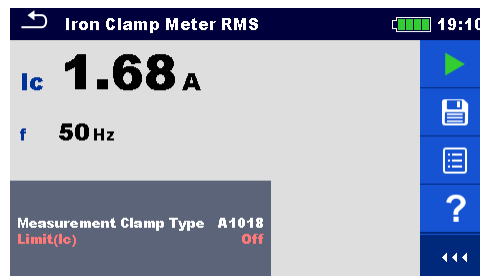

Figure 11.79: Example of Iron Clamp Meter RMS measurement result

Note:

- Consider displayed warnings when starting the measurement!



11.8.2 Flex Clamp Meter RMS Measurement

Test can be started from the Flex Clamp Meter RMS measurement window. Before carrying out a test the following parameters (Number of turns F1 - F4) can be edited.

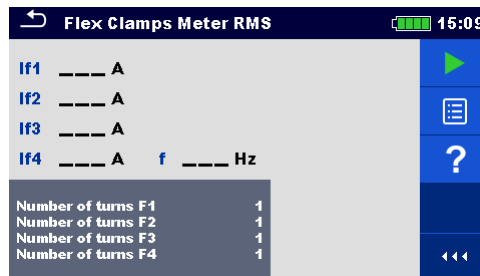

Figure 11.80: Flex Clamp Meter RMS measurement menu

Test parameters for Flex Clamp Meter RMS:

Number of turns F1 Set the number of turns for Flex 1 input terminal: [1, 2, 3, 4, 5, 6].

Number of turns F2 Set the number of turns for Flex 2 input terminal: [1, 2, 3, 4, 5, 6].

Number of turns F3 Set the number of turns for Flex 3 input terminal: [1, 2, 3, 4, 5, 6].

Number of turns F4 Set the number of turns for Flex 4 input terminal: [1, 2, 3, 4, 5, 6].

Flex Clamp Meter RMS Measurement procedure:

- Select the Flex Clamp Meter RMS measurement function.
- Set the test parameters (number of turns 1-4).
- Connect the flex clamps to the instrument and to the test object.
- Press the Run key to start the measurement.
- Wait until the test result is displayed on the screen.
- Press the Run key to stop the measurement.
- Save results (optional).

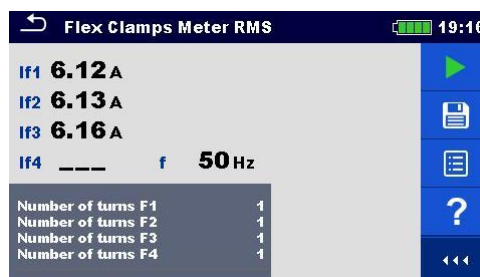

Figure 11.81: Example of Flex Clamp Meter RMS measurement result

Note:

- Consider displayed warnings when starting the measurement!

Notes (Flex):

- When using only one, two or three flex clamps, always connect one clamp to F1 terminal (synchronization port).
- Make sure that the arrow marked on the clamp coupling points toward the correct orientation for correct phase measurement.
- Make sure that the number of turns is correctly entered in the test parameters window.

11.9 Checkbox

The Checkbox provides a simple and effective means of checking the Earth Analyser instrument and accessories especially Flex and Iron Clamps.

Checkbox	Measurement	Test Mode	LF	HF	Filter	Test Voltage
Uh, Us, Ues, f, Igen, Ic, If1, If2, If3, If4	Check V – Meter	single	55 Hz	15 kHz	FFT	20/40 V
	Check A – Meter	single	55 Hz	15 kHz	FFT	20/40 V
	Check Iron, Flex Clamps	single	55 Hz	1,5 kHz	FFT	20/40 V

Table 11.82: Available Checkbox measurements in the MI 3290

Note:

- The Checkbox feature should be used to ensure that the meter is reading correctly between calibrations but should not be regarded as a substitute for a full manufacturer’s calibration on the unit.

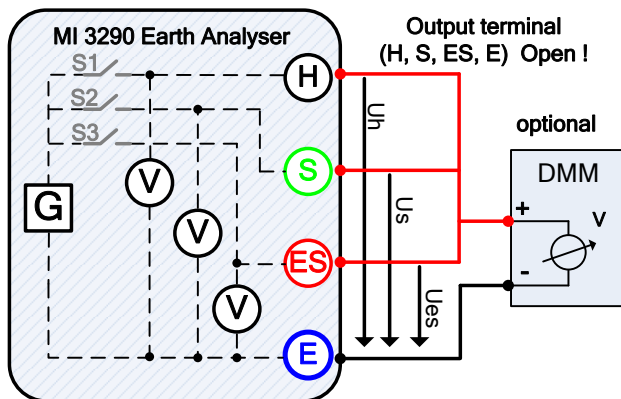

Figure 11.83: Checkbox measurements V-meter example

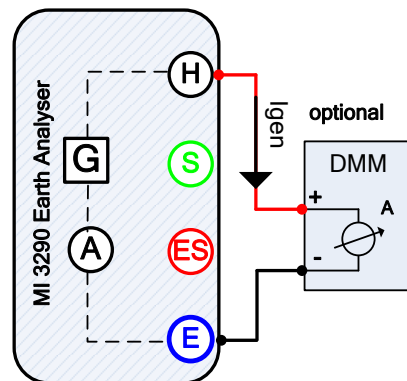

Figure 11.84: Checkbox measurements A-meter example

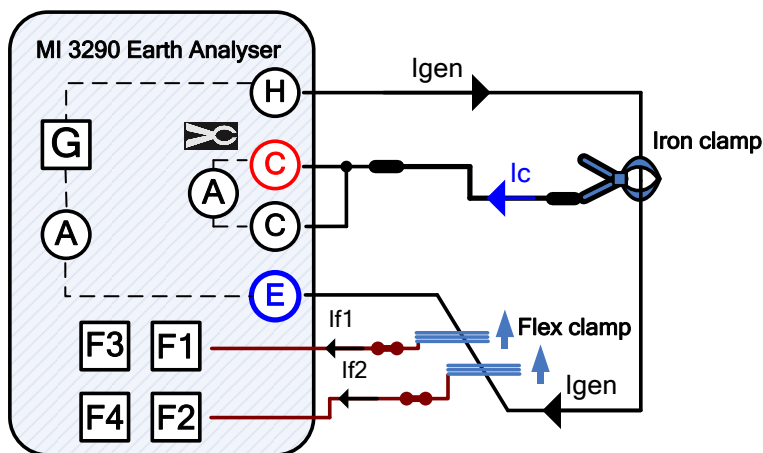

Figure 11.85: Checkbox measurements Iron, Flex Clamps example



11.9.1 Check V - Meter Measurement

Test can be started from the Check V-Meter measurement window. Before carrying out a test the following parameters (Test Voltage and Test Frequency) can be edited. Output terminals H, S, ES and E must be opened.

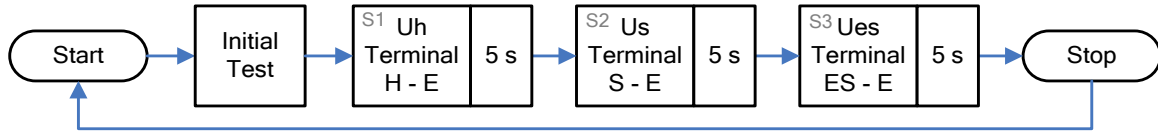

Figure 11.86: Check V-Meter measurement flow chart

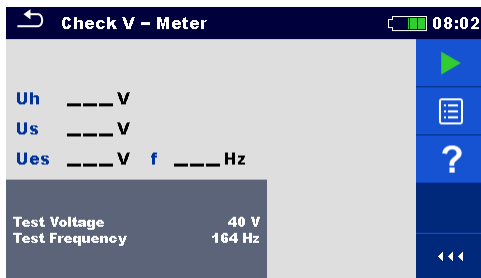

Figure 11.87: Check V-Meter measurement menu

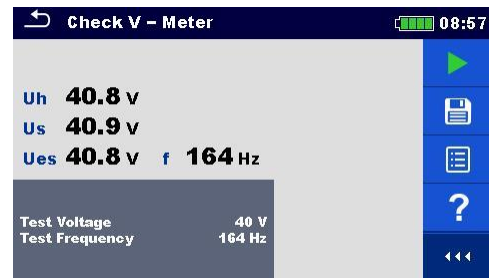

Figure 11.88: Example of Check V-Meter measurement result

Test parameters for Check V- Meter:

Test Voltage Set test voltage: [20 V or 40 V].

Test Frequency Set test frequency: [55 Hz, 82 Hz, 164 Hz, 329 Hz, 659 Hz, 1.31 kHz, 1.50 kHz, 2.63 kHz, 3.29 kHz, 6.59 kHz, 13.1 kHz, 15.0 kHz].

Check V-Meter Measurement procedure:

- Select the Check V-Meter measurement function.
- Set the test parameters (voltage and frequency).
- Disconnect accessories from H, S, ES and E terminals and connect reference V-meter.
- Press the Run key to start the measurement.
- Wait until the test result is displayed on the screen.
- Evaluate measurement results.
- Save results (optional).



11.9.2 Check A - Meter Measurement

Test can be started from the Check A-Meter measurement window. Before carrying out a test the following parameters (Test Voltage and Test Frequency) can be edited. Output terminals H and E must be shorted using reference A-meter.

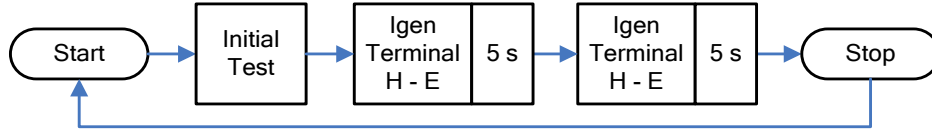

Figure 11.89: Check A-Meter measurement flow chart

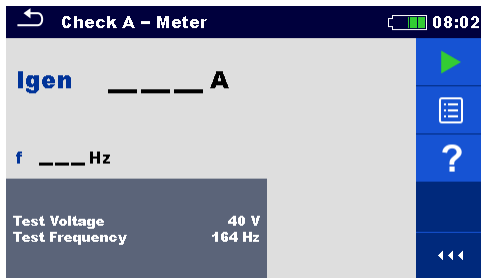

Figure 11.90: Check A-Meter measurement menu

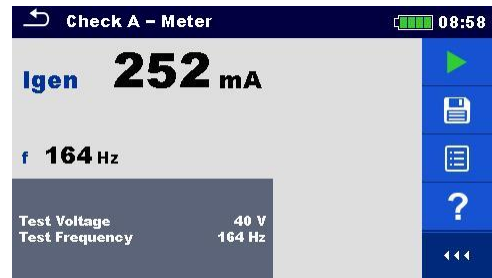

Figure 11.91: Example of Check A-Meter measurement result

Test parameters for Check A- Meter:

Test Voltage	Set test voltage: [20 V or 40 V].
Test Frequency	Set test frequency: [55 Hz, 82 Hz, 164 Hz, 329 Hz, 659 Hz, 1.31 kHz, 1.50 kHz, 2.63 kHz, 3.29 kHz 6.59 kHz, 13.1 kHz, 15.0 kHz].

Check A-Meter Measurement procedure:

- Select the Check A-Meter measurement function.
- Set the test parameters (voltage and frequency).
- Short H and E terminals using reference A-meter.
- Press the Run key to start the measurement.
- Wait until the test result is displayed on the screen.
- Evaluate measurement result.
- Save results (optional).



11.9.3 Check Iron, Flex Clamps Measurement

Test can be started from the Check Iron, Flex Clamps measurement window. Before carrying out a test the following parameters (Measurement Clamp Type, Test Voltage, Test Frequency and Number of turns F1 – F4) can be edited. Output terminals H and E must be shorted.

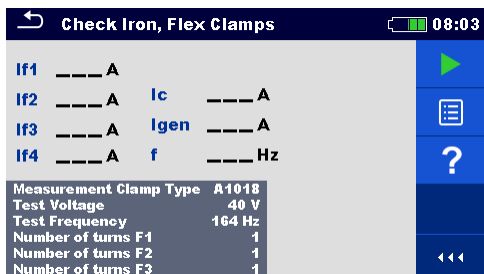

Figure 11.92: Check Iron, Flex Clamps measurement menu



Figure 11.93: Example of Check Iron, Flex Clamps measurement result

Test parameters for Check Iron, Flex Clamps measurement:

Measurement Clamp Type	Set iron clamp type: [A1018].
Test Voltage	Set test voltage: [20 V or 40 V].
Test Frequency	Set test frequency: [55 Hz, 82 Hz, 164 Hz, 329 Hz, 659 Hz, 1.31 kHz, 1.50 kHz].
Number of turns F1	Set the number of turns for Flex 1 input terminal: [1, 2, 3, 4, 5, 6].
Number of turns F2	Set the number of turns for Flex 2 input terminal: [1, 2, 3, 4, 5, 6].
Number of turns F3	Set the number of turns for Flex 3 input terminal: [1, 2, 3, 4, 5, 6].
Number of turns F4	Set the number of turns for Flex 4 input terminal: [1, 2, 3, 4, 5, 6].

Check Iron, Flex Clamps Measurement procedure:

- Select the Check Iron, Flex Clamps measurement function.
- Set the test parameters (clamp type, voltage, frequency and number of turns 1-4).
- Short H and E terminals.
- Connect iron/flex clamps to the instrument and embrace the wire that shorts H and E terminals.
- Press the Run key to start the measurement.
- Wait until the test result is displayed on the screen.
- Evaluate measurement results. (Compare it with displayed Igen current).
- Save results (optional).

Note:

- Consider displayed warnings when starting the measurement!

Notes (Flex):

- When using only one, two or three flex clamps, always connect one clamp to F1 terminal (synchronization port).
- Make sure that the arrow marked on the clamp coupling points toward the correct orientation for correct phase measurement.
- Make sure that the number of turns is correctly entered in the test parameters window.

12 Auto Tests

Pre-programmed sequences of measurements can be carried out in Auto test menu. The sequence of measurements, their parameters and flow of the sequence can be programmed. The results of an Auto test can be stored in the memory together with all related information.

Auto tests can be pre-programmed on PC with the Metrel ES Manager software and uploaded to the instrument. On the instrument parameters and limits of individual single test in the Auto test can be changed / set.

12.1 Selection of Auto tests

The Auto test list from Auto test groups menu should be selected first. Refer to chapter **8.8 Auto Test Groups** for more details. The Auto test to be carried out can then be selected from the Main Auto tests menu. This menu can be organized in structural manner with folders, sub-folders and Auto tests.

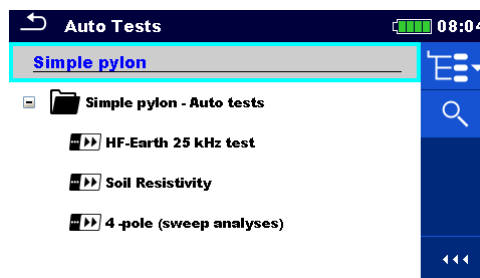

Figure 12.1: Main Auto tests menu

Options



Enters menu for more detail view of selected Auto test.

This option should also be used if the parameters / limits of the selected Auto test have to be changed. Refer to chapter **12.2.1 Auto test view menu** *Error! Reference source not found.* for more information.



Starts the selected Auto test.

The instrument immediately starts the Auto test.

12.2 Organization of Auto tests

An Auto test is divided into three phases:

- ❑ Before starting the first test the Auto test view menu is shown (unless it was started directly from the Main Auto tests menu). Parameters and limits of individual measurements can be set in this menu.
- ❑ During the execution phase of an Auto test, pre-programmed single tests are carried out. The sequence of single tests is controlled by pre-programmed flow commands.
- ❑ After the test sequence is finished the Auto test result menu is shown. Details of individual tests can be viewed and the results can be saved to Memory organizer.

12.2.1 Auto test view menu

In the Auto test view menu, the header and the single tests of selected Auto test are displayed. The header contains the name and description of the Auto test. Before starting the Auto test, test parameters / limits of individual measurements can be changed.

Auto test view menu (header is selected)

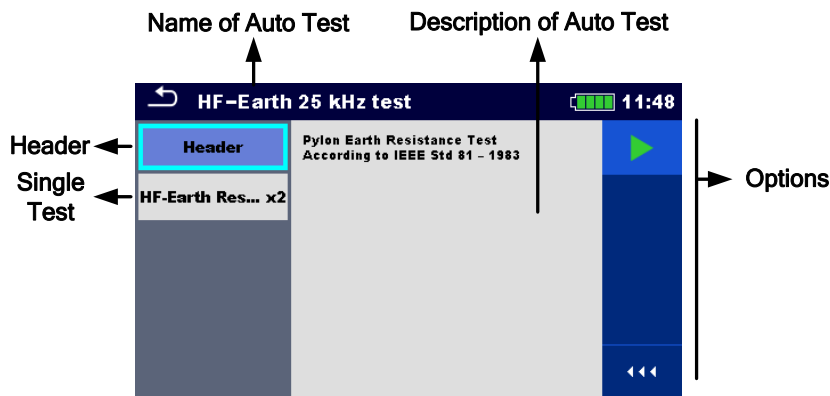

Figure 12.2: Auto test view menu – header selected

Options



Starts the Auto test.

Auto test view menu (measurement is selected)

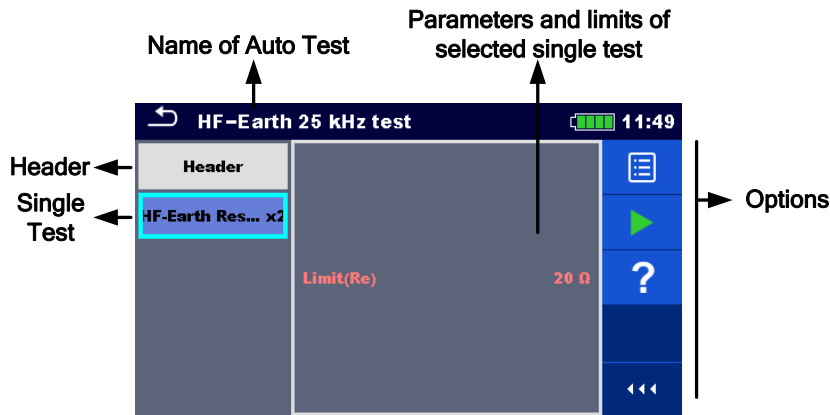

Figure 12.3: Auto test view menu – measurement selected

Options



Selects single test.



Opens menu for changing parameters and limits of selected measurements.



Refer to chapter **10.1.2 Setting parameters and limits of single tests** for more information how to change measurement parameters and limits.

Indication of Loops



The attached 'x2' at the end of single test name indicates that a loop of single tests is programmed. This means that the marked single test will be carried out as many times as the number behind the 'x' indicates. It is possible to exit the loop before, at the end of each individual measurement.

12.2.2 Step by step executions of Auto tests

While the Auto test is running it is controlled by pre-programmed flow commands. Examples of actions controlled by flow commands are:

- ❑ pauses during the test sequence
- ❑ buzzer
- ❑ proceeding of test sequence in regard to measured results

The actual list of flow commands is available on chapter *Error! Reference source not found. Error! Reference source not found.*

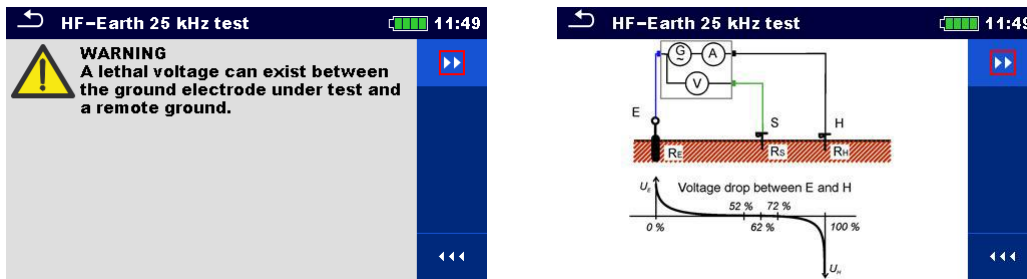

Figure 12.4: Auto test – example of a pause with message (text or picture)

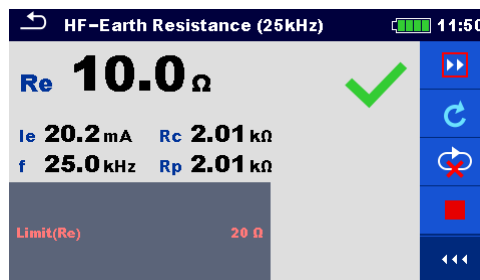

Figure 12.5: Auto test – example of a finished measurement with options for proceeding

Options (during execution of an auto test)



Proceeds to next step in the test sequence.



Repeats the measurement.
Displayed result of a single test will not be stored.



Ends the Auto test and goes to Auto test result screen.



Exits the loop of single tests and proceeds to the next step in the test sequence.

The offered options in the control panel depend on the selected single test, its result and the programmed test flow.

12.2.3 Auto test result screen

After the Auto test sequence is finished the Auto test result screen is displayed. At the left side of the display the single tests and their statuses in the Auto test are shown. In the middle of the display the header of the Auto test is displayed. At the top the overall Auto test status is displayed. Refer to chapter **9.1.1 Measurement statuses** for more information.

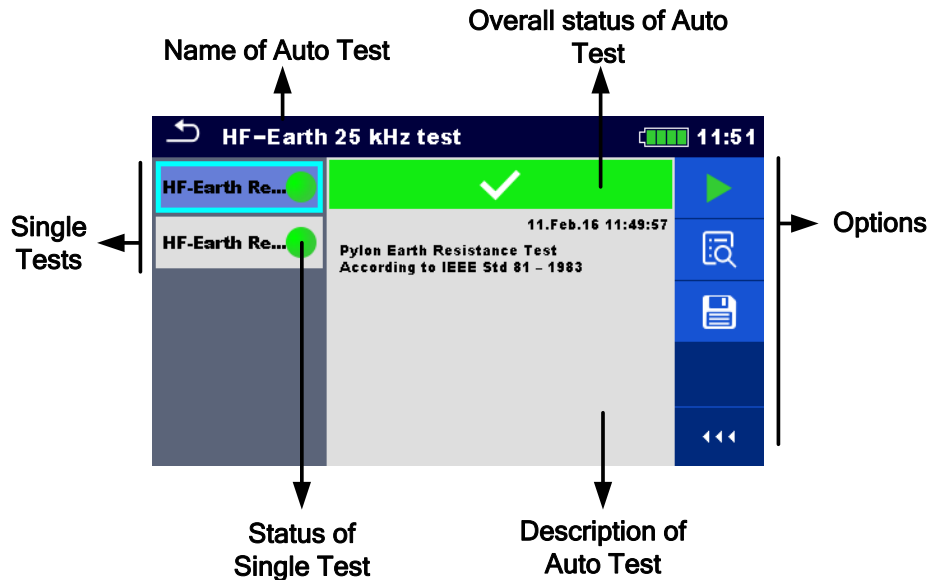

Figure 12.6: Auto test result screen

Options



Start Test
Starts a new Auto test.



View results of individual measurements.
The instrument goes to menu for viewing details of the Auto test.



Saves the Auto test results.
A new Auto test was selected and started from a Structure object in the structure tree:

- The Auto test will be saved under the selected Structure object.

A new Auto test was started from the Auto test main menu:

- Saving under the last selected Structure object will be offered by default. The user can select another Structure object or create a new Structure object. By pressing  in Memory organizer menu the Auto test is saved under selected location.

An empty measurement was selected in structure tree and started:

- The result(s) will be added to the Auto test. The Auto test will change its overall status from 'empty' to 'finished'.

An already carried out Auto test was selected in structure tree, viewed and then restarted:

- A new Auto test will be saved under the selected Structure object.

Options in menu for viewing details of Auto test results



Details of selected single test in Auto test are displayed.



Opens menu for viewing parameters and limits of selected measurements. Refer to chapter **10.1.2 Setting parameters and limits of single tests** for more information.



on

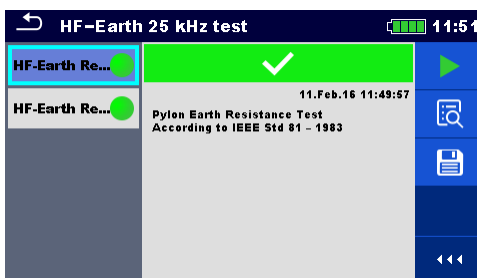

Figure 12.7: Details of menu for viewing details of Auto test results

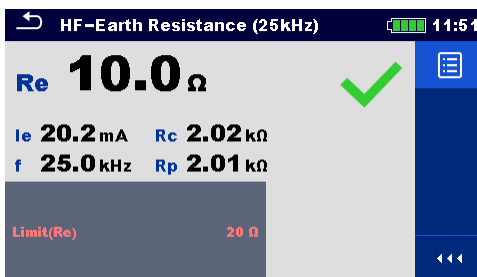

Figure 12.8: Details of single test in Auto test result menu

12.2.4 Auto test memory screen

In Auto test memory screen details of the auto test can be viewed and a new Auto test can be restarted.

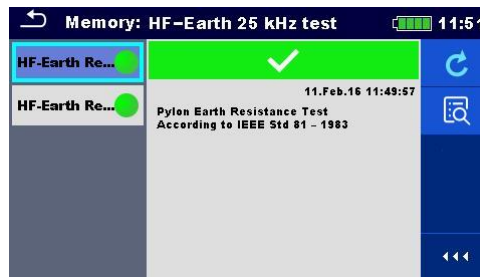

Figure 12.9: Auto test memory screen

Options



Retest the Auto test.
Enters menu for a new Auto test.



Enters menu for viewing details of the Auto test.

13 Communication

The instrument can communicate with the Metrel ES Manager PC software. The following action is supported:

- ❑ Saved results and Tree structure from Memory organizer can be downloaded and stored to a PC.
- ❑ Tree structure and Auto tests from Metrel ES Manager PC software can be uploaded to the instrument.

Metrel ES Manager is PC software running on Windows 7, Windows 8, Windows 8.1 and Windows 10. There are two communication interfaces available on the instrument: USB and Bluetooth.

How to establish an USB link:

- ❑ Connect a PC USB port to the instrument USB connector using the USB interface cable.
- ❑ Switch on the PC and the instrument.
- ❑ Run the Metrel ES Manager software.
- ❑ Set the desired communication port. (COM port is identified as "USB Serial Port".)
- ❑ If not visible, make sure to install the correct USB driver (see notes).
- ❑ The instrument is prepared to communicate with the PC over USB.

Bluetooth communication

The internal Bluetooth module enables easy communication via Bluetooth with PC and Android devices.

How to configure a Bluetooth link between instrument and PC:

- ❑ Switch On the instrument.
- ❑ On PC configure a Standard Serial Port to enable communication over Bluetooth link between instrument and PC. Usually no code for pairing the devices is needed.
- ❑ Run the Metrel ES Manager software.
- ❑ Set the configured communication port.
- ❑ The instrument is prepared to communicate with the PC over Bluetooth.

Notes:

- ❑ USB drivers should be installed on PC before using the USB interface. Refer to USB installation instructions available on installation CD or download the drivers from the <http://www.ftdichip.com> website (MI 3290 is using the FT230X chip).
- ❑ The name of correctly configured Bluetooth device must consist of the instrument type plus serial number, eg. MI 3290-12345678I.
- ❑ Bluetooth communication device pairing code is NNNN.

14 Maintenance

Unauthorized persons are not allowed to open the Earth Analyser instrument. There are no user replaceable components inside the instrument. Batteries can only be replaced with certified ones and only by authorized persons.

14.1 Cleaning

No special maintenance is required for the housing. To clean the surface of the instrument, use a soft cloth slightly moistened with soapy water or alcohol. Then leave the instrument to dry totally before use.

Warnings:

- ❑ Do not use liquids based on petrol or hydrocarbons!
- ❑ Do not spill cleaning liquid over the instrument!

14.2 Periodic calibration

It is essential that the test instrument is regularly calibrated in order that the technical specification listed in this manual is guaranteed. We recommend an annual calibration. Only an authorized technical person can do the calibration. Please contact your dealer for further information.

14.3 Service

For repairs under warranty, or at any other time, please contact your distributor.

14.4 Upgrading the instrument

The instrument can be upgraded from a PC via the USB communication port. This enables to keep the instrument up to date even if the standards or regulations change. The firmware upgrade requires internet access and can be carried out from the **Metrel ES Manager software** with a help of special upgrading software – FlashMe which will guide you through the upgrading procedure. For more information, refer to Metrel ES Manager Help file.

Note:

- ❑ See chapter **13 Communication** for details on USB driver installation.

15 Technical specifications

15.1 Earth [Ze]

15.1.1 2, 3, 4 - pole

Measurement principle Voltage / Current measurement

Earth	Test frequency	Measuring range	Resolution	Uncertainty (* See notes)
Ze	55 Hz ... 329 Hz	0,00 Ω ... 19,99 Ω	0,01 Ω	±(3 % of reading + 3 digits)
		20,0 Ω ... 199,9 Ω	0,1 Ω	
		200 Ω ... 999 Ω	1 Ω	
		1,000 kΩ ... 1,999 kΩ	0,001 kΩ	
		2,00 kΩ ... 19,99 kΩ	0,01 kΩ	
	659 Hz ... 2,63 kHz	0,00 Ω ... 19,99 Ω	0,01 Ω	±(5 % of reading + 3 digits)
		20,0 Ω ... 199,9 Ω	0,1 Ω	
		200 Ω ... 999 Ω	1 Ω	
		1,000 kΩ ... 1,999 kΩ	0,001 kΩ	
	3,29 kHz ... 15,0 kHz	0,00 Ω ... 19,99 Ω	0,01 Ω	±(8 % of reading + 3 digits)
		20,0 Ω ... 199,9 Ω	0,1 Ω	

Test mode single or sweep

Open-terminal test voltage 20 or 40 Vac

Test frequency 55 Hz, 82 Hz, 164 Hz, 329 Hz, 659 Hz, 1.31 kHz, 1.50 kHz,
2.63 kHz, 3.29 kHz, 6.59 kHz, 13.1 kHz, 15.0kHz

Short-circuit test current > 220 mA @ 164 Hz, 40 Vac

Limit range (Ze) 0,1 Ω ... 5 kΩ (OFF)

Test voltage shape sine wave

Ze definition Impedance value Z(f).

Re definition Impedance, excluding reactance R.

Measuring time see Table 15.2

Automatic test of probe resistance yes (3, 4 - pole)

Automatic connection test yes [H, S, ES, E]

Automatic range selection yes

Automatic test of voltage noise yes

** Notes:*

- *Uncertainty depends on the correct compensation of the test leads for 2, 3 – pole, and resistance of probes and auxiliary earth electrodes (15.7 Influence of the auxiliary electrodes).*
- *When measuring at high frequencies > 659 Hz special attention should be given to wiring, parasitic effects, etc. Use the guard terminal for H.*

15.1.2 Selective (Iron Clamp)

Measurement principle: Voltage / Current (external Iron Clamp) measurement

Selective Earth Impedance	Test frequency	Measuring range	Resolution	Uncertainty
Zsel	55 Hz ... 329 Hz	0,00 Ω ... 19,99 Ω	0,01 Ω	±(8 % of reading + 3 digits)
		20,0 Ω ... 199,9 Ω	0,1 Ω	
		200 Ω ... 999 Ω	1 Ω	
		1,000 kΩ ... 1,999 kΩ	0,001 kΩ	
		2,00 kΩ ... 19,99 kΩ	0,01 kΩ	
	659 Hz ... 1,50 kHz	0,00 Ω ... 19,99 Ω	0,01 Ω	
		20,0 Ω ... 199,9 Ω	0,1 Ω	
		200 Ω ... 999 Ω	1 Ω	
		1,000 kΩ ... 1,999 kΩ	0,001 kΩ	

- Test mode single or sweep
- Open-terminal test voltage 40 Vac
- Test frequency 55 Hz, 82 Hz, 164 Hz, 329 Hz, 659 Hz, 1.31 kHz, 1.50 kHz
- Short-circuit test current > 220 mA @ 164 Hz, 40 Vac
- Limit range (Zsel) 0,1 Ω ... 5 kΩ (OFF)
- Test voltage shape sine wave
- Zsel definition Impedance value Z(f).
- Measuring time see Table 15.2
- Measurement Clamp type A1018
- Automatic test of probe resistance yes
- Automatic connection test yes [H, S, ES, E]
- Automatic range selection yes
- Automatic test of voltage noise yes
- Low clamp current indication yes [Ic]

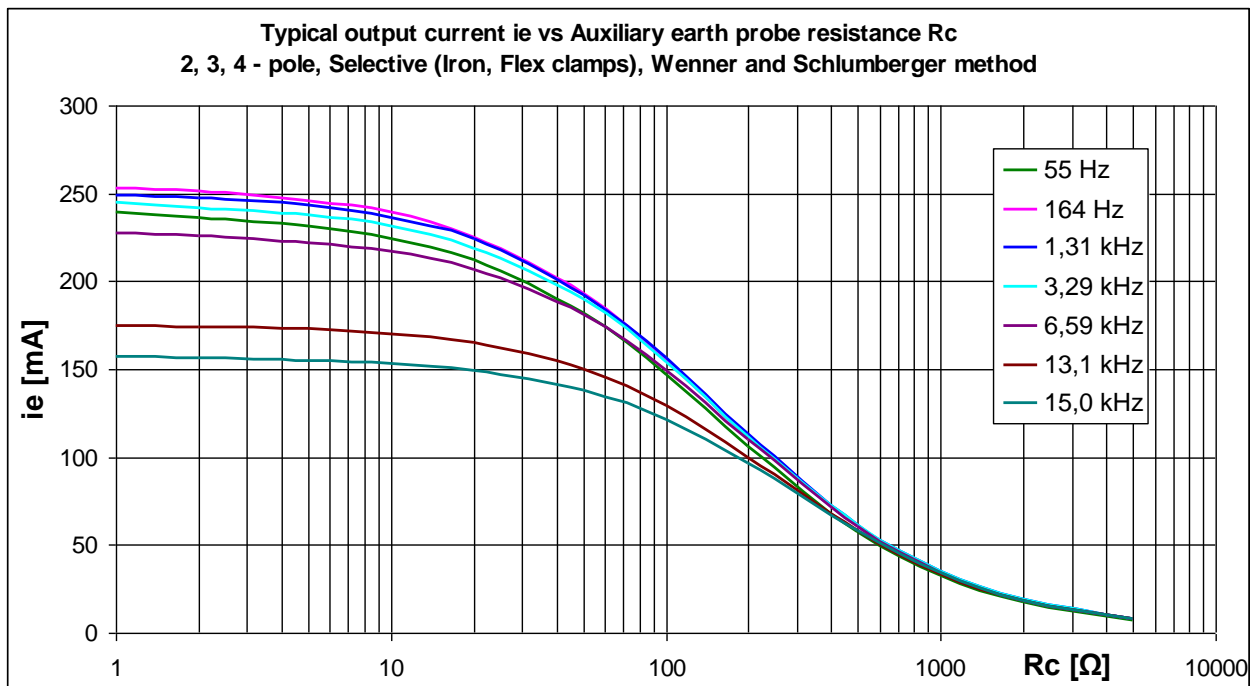

15.1.3 2 Clamps

Measurement principle: Measurement of resistance in closed loops using two iron current clamps

Loop Impedance	Measuring range	Resolution	Uncertainty
Ze	0,00 Ω ... 9,99 Ω	0,01 Ω	$\pm(5\%$ of reading + 2 digits)
	10,0 Ω ... 49,9 Ω	0,1 Ω	$\pm(10\%$ of reading + 2 digits)
	50 Ω ... 100 Ω	1 Ω	$\pm(20\%$ of reading)

Test mode.....continuous
 Distance between test clamps > 30 cm (min)
 Test frequency 82 Hz, 164 Hz, 329 Hz
 Limit range (Ze) 0,1 Ω ... 40 Ω (OFF)
 Test voltage shape.....sine wave
 Ze definition Impedance value Z(f).
 Measuring refresh rate..... typical 3 s at 164 Hz (depending on test frequency)
 Measurement Clamp type A1018
 Generator Clamp type A1019
 Automatic range selection yes
 Automatic test of voltage noise yes
 Low clamp current indication..... yes [Ic]

Typical loop (test) current	Loop Impedances					
	10 m Ω	100 m Ω	500 m Ω	1 Ω	5 Ω	10 Ω
164 Hz	6,8 A	0,36 A	80 mA	40 mA	8 mA	4 mA

Table 15.1: Typical loop (test) current for different loop impedances

15.1.4 Passive (Flex Clamps 1-4)

Measurement principle: Voltage / Current (external Flex Clamp) measurement

Total Earth Impedance	Measuring range	Resolution	Uncertainty
Ztot	0,00 Ω ... 19,99 Ω	0,01 Ω	$\pm(8\%$ of reading + 3 digits)
	20,0 Ω ... 199,9 Ω	0,1 Ω	
	200 Ω ... 999 Ω	1 Ω	
	1,000 Ω ... 1,999 Ω	0,001 k Ω	
	2,00 k Ω ... 19,99 k Ω	0,01 k Ω	

Test mode.....continuous
 Nominal frequency 45 Hz ... 150 Hz
 Limit range (Zsel) 0,1 Ω ... 5 k Ω (OFF)
 Ztot definition..... Impedance value Z(f).
 Measuring refresh rate..... typical 6 s
 Input resistance (S) 1,2 M Ω
 Automatic connection test yes [S]
 Automatic range selection yes
 Automatic test of voltage noise yes
 Low clamp current indication..... yes [If1, If2, If3, If4]
 Automatic clamp recognition yes [F1, F2, F3, F4]

15.1.5 HF Earth Resistance (25 kHz)

Measurement principle Current / Voltage measurement

Earth Resistance	Measuring range	Resolution	Uncertainty
Re	0,0 Ω ... 19,9 Ω	0,1 Ω	±(3 % of reading + 2 digits)
	20 Ω ... 299 Ω	1 Ω	

- Test mode single
- Open-terminal test voltage 40 Vac
- Test voltage frequency 25 kHz
- Short-circuit test current > 40 mA
- Limit range (Re) 1 Ω ... 100 Ω (OFF)
- Test voltage shape sine wave
- Re definition Impedance excluding the reactance value
- Measuring time typical 10 s
- Automatic test of probe resistance yes
- Automatic connection test yes [H, S, E]
- Automatic range selection yes
- Automatic test of voltage noise yes
- Automatic compensation of inductive component yes
- Guard terminal yes

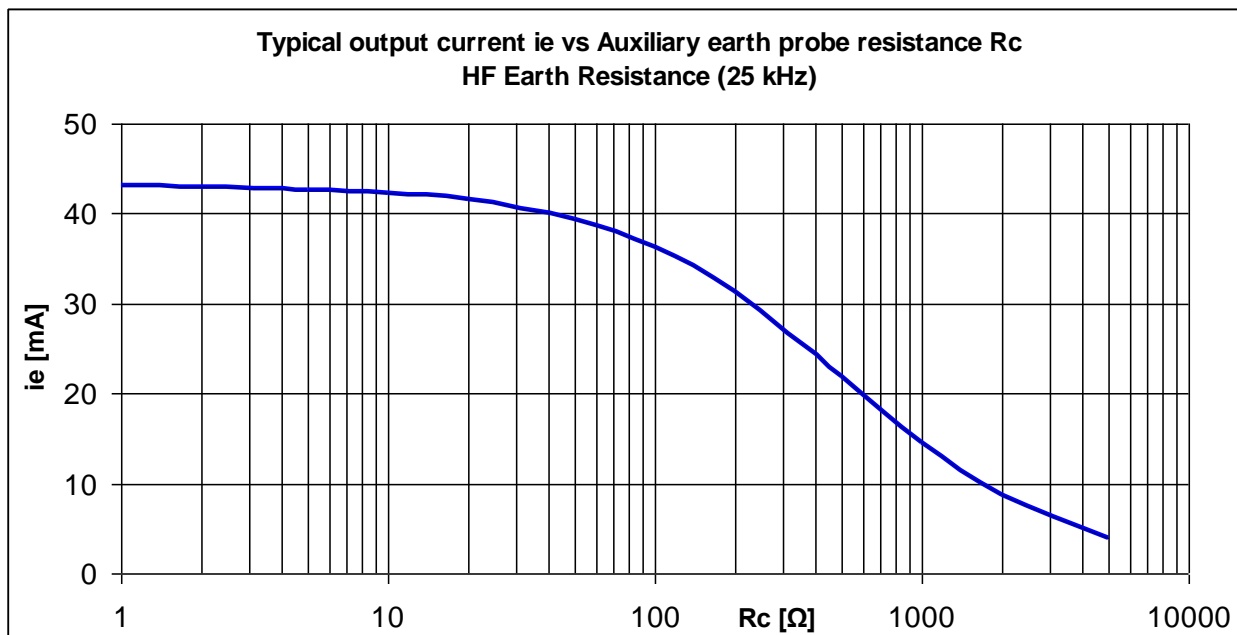

15.1.6 Selective (Flex Clamps 1 - 4)

Measurement principle: Voltage / Current (external Flex Clamp) measurement

Total Earth Impedance	Test frequency	Measuring range	Resolution	Uncertainty
Z_{tot}	55 Hz ... 329 Hz	0,00 Ω ... 19,99 Ω	0,01 Ω	±(8 % of reading + 3 digits)
		20,0 Ω ... 199,9 Ω	0,1 Ω	
		200 Ω ... 999 Ω	1 Ω	
		1,000 kΩ ... 1,999 kΩ	0,001 kΩ	
		2,00 kΩ ... 19,99 kΩ	0,01 kΩ	
	659 Hz ... 1,50 kHz	0,00 Ω ... 19,99 Ω	0,01 Ω	
		20,0 Ω ... 199,9 Ω	0,1 Ω	
		200 Ω ... 999 Ω	1 Ω	
		1,000 kΩ ... 1,999 kΩ	0,001 kΩ	

Test mode single or sweep

Open-terminal test voltage 40 Vac

Test frequency 55 Hz, 82 Hz, 164 Hz, 329 Hz, 659 Hz, 1.31 kHz, 1.50 kHz

Short-circuit test current > 220 mA @ 164 Hz, 40 Vac

Limit range (Z_{tot}) 0,1 Ω ... 5 kΩ (OFF)

Test voltage shape sine wave

Z_{tot} definition Impedance value Z(f)

Measuring time see Table 15.2

Automatic test of probe resistance yes

Automatic connection test yes [H, S, ES, E]

Automatic range selection yes

Automatic test of voltage noise yes

Low clamp current indication yes [If1, If2, If3, If4]

Automatic clamp recognition yes [F1, F2, F3, F4]

Typical Measuring time	Measurement				
	2 – pole	3 – pole	4 – pole	Selective (Iron Clamp)	Selective (Flex Clamp 1-4)
55 Hz	17 s	32 s	45 s	57 s	1:13 s
329 Hz	8 s	11 s	15 s	19 s	23 s
1.50 kHz	6 s	10 s	12 s	15 s	18 s
6.59 kHz	6 s	9 s	12 s	/	/
15.0 kHz	6 s	9 s	11 s	/	/
sweep	56 s	1:45 s	2:34 s	2:34 s	3:14 s (1 x Flex Clamp)

Table 15.2: Typical measuring times for different measurements

15.2 Specific Earth Resistance Measurements [ρ]

15.2.1 Wenner and Schlumberger method

Measurement principle Voltage / Current measurement

Specific Earth	Measuring range	Resolution	Uncertainty
ρ	0,00 Ω m ... 19,99 Ω m	0,01 Ω m	calculated value (consider uncertainty of 4 – pole measurement)
	20,0 Ω m ... 199,9 Ω m	0,1 Ω m	
	200 Ω m ... 999 Ω m	1 Ω m	
	1,000 k Ω m ... 1,999 k Ω m	0,001 k Ω m	
	2,00 k Ω m ... 19,99 k Ω m	0,01 k Ω m	

Specific Earth	Measuring range	Resolution	Uncertainty
ρ	0,00 Ω ft ... 19,99 Ω ft	0,01 Ω ft	calculated value (consider uncertainty of 4 – pole measurement)
	20,0 Ω ft ... 199,9 Ω ft	0,1 Ω ft	
	200 Ω ft ... 999 Ω ft	1 Ω ft	
	1,000 k Ω ft ... 1,999 k Ω ft	0,001 k Ω ft	
	2,00 k Ω ft ... 59,99 k Ω ft	0,01 k Ω ft	

Test mode single
 Open-terminal test voltage 20 Vac or 40 Vac
 Test frequency 164 Hz
 Short-circuit test current > 220 mA @ 164 Hz, 40 Vac
 Limit range (ρ) 0,1 Ω m ... 15 k Ω m (OFF)
 Limit range (ρ) 1 Ω ft ... 40 k Ω ft (OFF)
 Test voltage shape sine wave
 Measuring time see Table 15.2
 Automatic test of probe resistance yes
 Automatic connection test yes [H, S, ES, E]
 Automatic range selection yes
 Automatic test of voltage noise yes

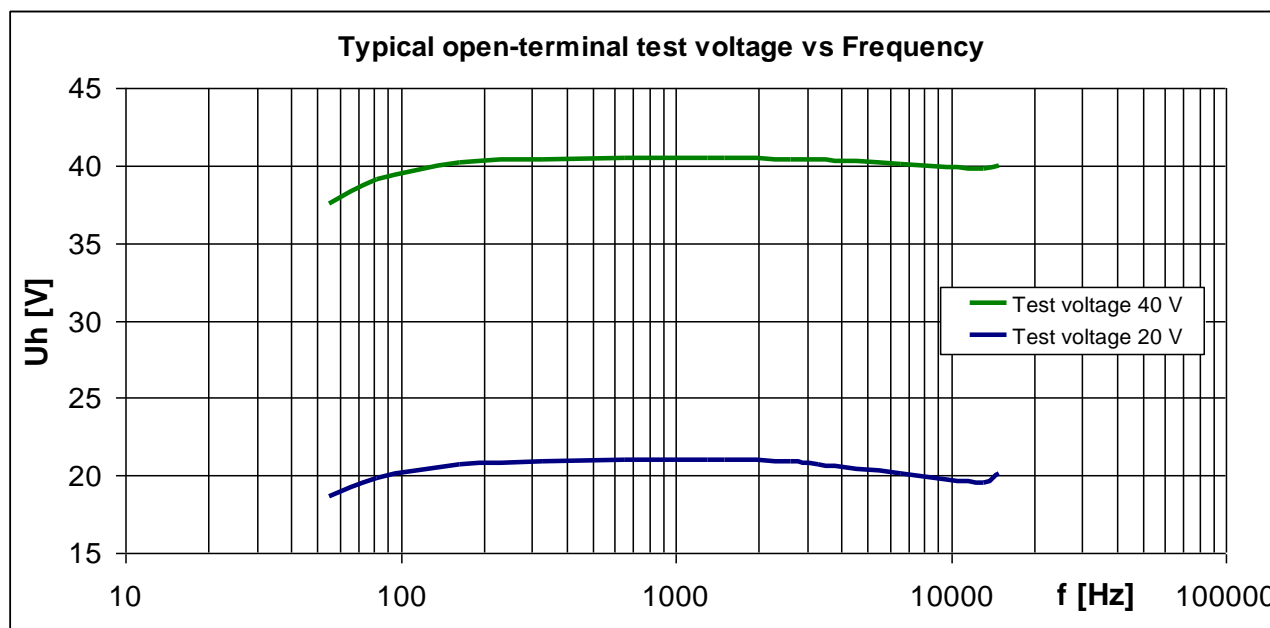

15.3 Earth Potential [Vp]

15.3.1 Potential ratio

Measurement principle: Voltage measurement

Potential ratio	Measuring range	Resolution	Uncertainty (* See notes)
Vp	0,001 ... 1,000	0,001	±(2 % of reading + 2 digits)

Test mode.....single

Open-terminal test voltage40 Vac

Test frequency.....55 Hz, 82 Hz, 164 Hz, 329 Hz

Short-circuit test current.....> 220 mA @ 164 Hz

Test voltage shape.....sine wave

Vp definition.....The inverted value of Us voltage divided by Uh voltage.

Input resistance (S) 1,2 MΩ

Measuring time typical 10 s at 164 Hz (depending on test frequency)

Automatic connection testyes [H, S, E]

Automatic range selectionyes

Automatic test of voltage noiseyes

* Notes:

- Uncertainty depends on the minimal Rc probe resistance of > 300 Ω.

15.3.2 S&T Current Source

Measurement principleCurrent (MI 3290) / Voltage measurement (MI 3295M)

MI 3290 (current source)

Current	Measuring range	Resolution	Accuracy
Igen	0,0 mA ... 99,9 mA	0,1 mA	±(2 % of reading + 2 digits)
	100 mA ... 999 mA	1 mA	

Test mode.....continues

Open-terminal test voltage40 Vac

Test current frequency.....55 Hz, 82 Hz, 164 Hz, 329 Hz

Min test current.....> 50 mA

Output generator impedance.....~ 100 Ω

Test voltage shape.....sine wave

Automatic connection testyes [H, E]

MI 3295M (meter)

Voltage	Measuring range	Resolution	Accuracy
Um	0,01 mV ... 19,99 mV	0,01 mV	±(2 % of reading + 2 digits)
	20,0 mV ... 199,9 mV	0,1 mV	
	200 mV ... 1999 mV	1 mV	
	2,00 V ... 19,99 V	0,01 V	
	20,0 V ... 59,9 V	0,1 V	

Test mode.....single

Input resistance (selectable)1 kΩ, 1 MΩ

Ifault range (selectable)..... 10 A ... 200 kA

Noise rejection DSP filtering 55 Hz, 64 dB rejection of 50 (60) Hz noise

Step and Touch	Measuring range	Resolution	Accuracy
Us, Ut	0,0 V ... 199,9 V	0,1 V	calculated value
	200 V ... 999 V	1 V	

Displayed Step / Touch Voltage is obtained on base of calculation: Us, Ut = Um · (Ifault / Igen)

15.4 Impulse Impedance [Zp]

15.4.1 Impulse Measurement

Measurement principle: Voltage (peak) / Current (peak) measurement

Impulse Impedance	Measuring range	Resolution	Uncertainty
Zp	0,0 Ω ... 19,9 Ω	0,1 Ω	±(8 % of reading + 8 digits)
	20 Ω ... 199 Ω	1 Ω	

Test mode single
 Open-terminal test voltage ~120 V_{peak}
 Short-circuit test current ~6 A_{peak}
 Impulse waveform 10 / 350 μs
 Zp Definition The peak voltage divided by the peak current.
 Limit range (Zp) 1 Ω ... 100 Ω (OFF)
 Measuring time typical 20 s
 Automatic connection test yes [H, S, E]
 Automatic test of probe resistance yes (at 3,29 kHz)
 Automatic test of voltage noise yes
 Guard terminal yes

Influence of the auxiliary electrodes

The current probe R_c and potential probe R_p are measured using 3-Pole measurement at a fix frequency 3,29 kHz @ 40 Vac open-terminal test voltage.

R_c and R_p max. (> 100 Ω + (40 * R_a)) or 1 kΩ (whichever is lower)

Additional error if R_c or R_p max. is exceeded ±(20 % of reading)

Influence of noise

Max noise interference voltage on terminals H, S and E 1 V rms

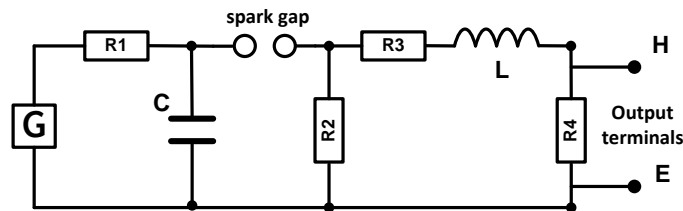

Figure 15.1: Simplified circuit of impulse generator in the MI 3290

where:

G High voltage source
 R1 Charging resistor
 C Energy storage capacitor
 R2, R4 Impulse duration shaping resistors
 R3 Impedance matching resistor
 L Impulse rise time shaping inductor

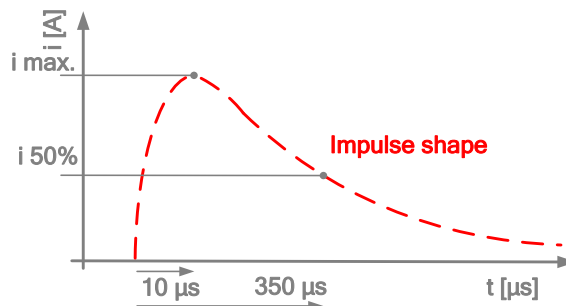

Figure 15.2: Typical Impulse shape short-circuit

15.5 DC Resistance [R]

15.5.1 Ω - Meter (200mA)

Measurement principle: Voltage (dc) / Current (dc) measurement

DC Resistance	Measuring range	Resolution	Uncertainty (* See note)
R	0,00 Ω ... 19,99 Ω	0,01 Ω	±(2 % of reading + 2 digits)
	20,0 Ω ... 199,9 Ω	0,1 Ω	
	200 Ω ... 999 Ω	1 Ω	
	1,00 kΩ ... 1,99 kΩ	10 Ω	

Test mode.....single
 Open-terminal test voltage~20 V_{dc}
 Short-circuit test current.....min. 200 mA_{dc} into load resistance of 2 Ω
 Test current direction.....unidirectional
 Max inductivity 2 H
 Limit range (R)0,1 Ω ... 40 Ω (OFF)
 Measuring time typical 5 s
 Test method2-wire
 Test lead compensation yes up to 5 Ω
 Automatic range selectionyes
 Automatic test of voltage noise yes

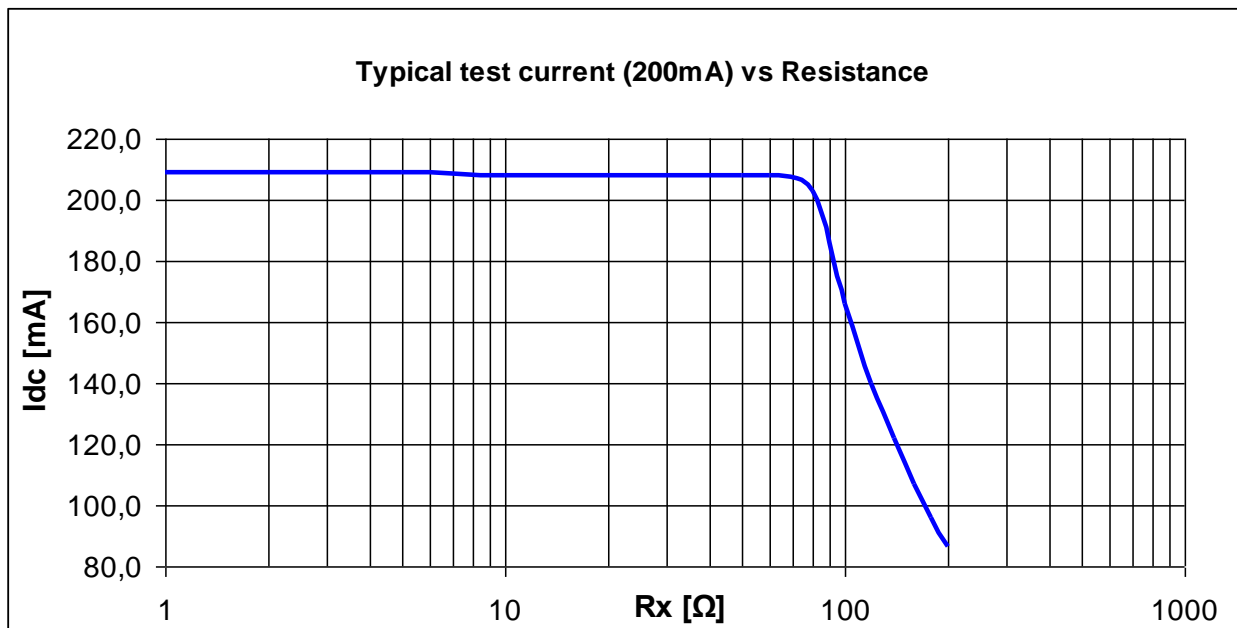

* Note:

- Uncertainty depends on the correct compensation of the test leads.

15.5.2 Ω - Meter (7mA)

Measurement principle: Voltage (dc) / Current (dc) measurement

DC Resistance	Measuring range	Resolution	Uncertainty (* See note)
R	0,0 Ω ... 199,9 Ω	0,1 Ω	±(3 % of reading + 2 digits)
	200 Ω ... 999 Ω	1 Ω	
	1,00 kΩ ... 9,99 kΩ	0,01 kΩ	
	10,0 kΩ ... 19,9 kΩ	0,1 kΩ	

Test mode.....continuous
 Open-terminal test voltage~20 V_{dc}
 Short-circuit test current.....~7,2 mA_{dc}
 Test current direction.....unidirectional
 Limit range (R)1 Ω ... 15,0 kΩ (OFF)
 Measuring refresh rate..... typical 2 s
 Test method2-wire
 Test lead compensation yes, up to 5 Ω
 Automatic range selectionyes
 Automatic test of voltage noiseyes

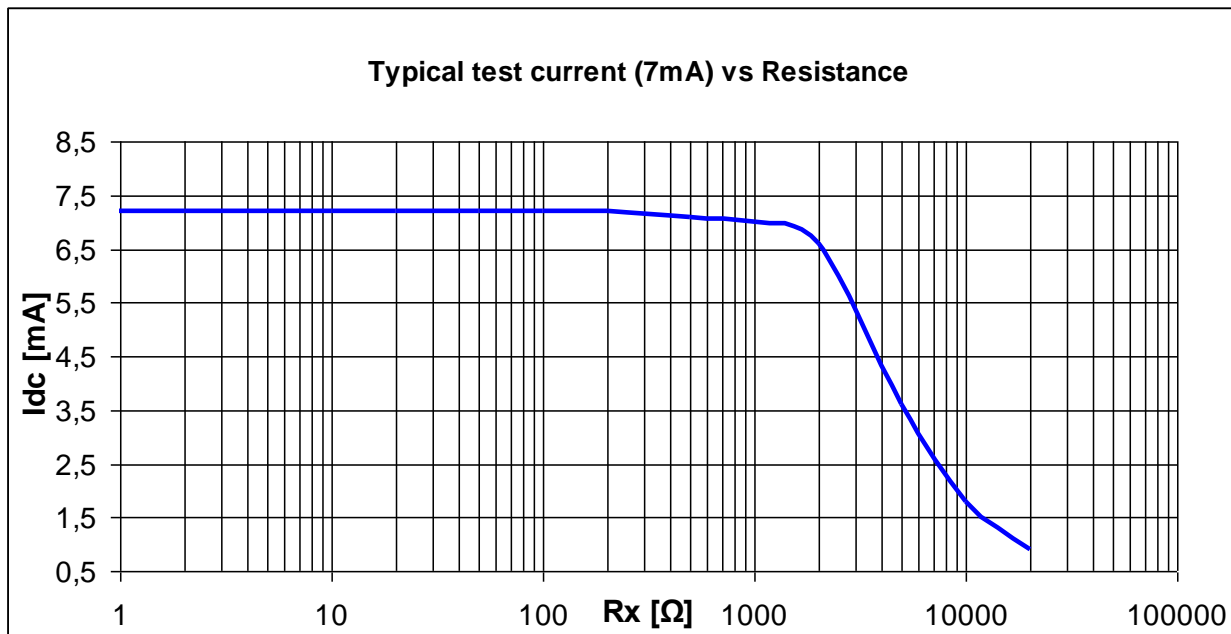

* Note:

- Uncertainty depends on the correct compensation of the test leads (2-wire).

15.6 AC Impedance [Z]

15.6.1 Impedance Meter

Measurement principle: Voltage (ac) / Current (ac) measurement

AC Impedance	Test frequency	Measuring range	Resolution	Uncertainty
Z	55 Hz ... 15,0 kHz	0,00 Ω ... 19,99 Ω	0,01 Ω	$\pm(3\%$ of reading + 2 digits)
		20,0 Ω ... 199,9 Ω	0,1 Ω	
		200 Ω ... 999 Ω	1 Ω	
		1,000 k Ω ... 1,999 k Ω	0,001 k Ω	
		2,00 k Ω ... 19,99 k Ω	0,01 k Ω	

Test mode single or sweep
 Open-terminal test voltage 20 Vac or 40 Vac
 Test voltage frequency 55 Hz, 82 Hz, 164 Hz, 329 Hz, 659 Hz, 1.31 kHz, 1.50 kHz,
 2.63 kHz, 3.29 kHz, 6.59 kHz, 13.1 kHz, 15.0 kHz
 Short-circuit test current > 220 mA @ 164 Hz, 40 Vac
 Limit range (R) 1 Ω ... 15,0 k Ω (OFF)
 Test voltage shape sine wave
 Measuring time typical 10 s at 164 Hz (depending on test frequency)
 Test method 4-wire
 Rc1 + Rc2. 5 Ω max.
 Rp1 + Rp2 5 Ω max.
 Automatic connection test yes [C1, P1, P2, C2]
 Automatic range selection yes
 Automatic test of voltage noise yes

15.7 Current [I]

15.7.1 Iron Clamp Meter RMS

Measurement principle: Current measurement (RMS)

Current RMS	Measuring range	Resolution	Uncertainty (* See note)
I	1,0 mA ... 99,9 mA	0,1 mA	$\pm(2\%$ of reading + 3 digits)
	100 mA ... 999 mA	1 mA	
	1,00 A ... 7,99 A	0,01 A	

Test mode continuous
 Input impedance 10 Ω (1/4W max)
 Nominal frequency 45 Hz ... 1,5 kHz
 Measuring refresh rate typical 1 s
 Limit range (I) 10 mA ... 9,00 A (OFF)
 Measurement Clamp type A1018
 Automatic range selection yes

* Note:

- Do not measure close to other current-carrying conductors if possible. An external magnetic field can cause an additional measurement uncertainty.

Clamps	External magnetic field	Additional uncertainty
Iron clamp (A1018)	30 A/m	$\pm(15\%$ of reading)

15.7.2 Flex Clamps Meter RMS

Measurement principle:Current measurement (RMS)

Current RMS	Measuring range	Resolution	Uncertainty (* See note)
If1, If2, If3, If4	10 mA ... 99,9 mA	0,1 mA	±(8 % of reading + 3 digits)
	100 mA ... 999 mA	1 mA	
	1,00 A ... 9,99 A	0,01 A	
	10,0 A ... 49,9 A	0,1 A	

Test mode.....continuous
 Input impedance (F1 –F4).....10 kΩ
 Nominal frequency.....45 Hz ... 1,5 kHz
 Measuring refresh rate..... typical 2 s
 Measurement Clamp typeA1487
 Automatic range selectionyes
 Automatic clamp recognitionyes [F1, F2, F3, F4]

* Note:

- Current RMS measurement ranges and uncertainty for one turn except for the measurement range of 10 mA ... 99,9 mA, which must be at least 3 turns.
- Do not measure close to other current-carrying conductors if possible. An external magnetic field can cause an additional measurement uncertainty.

Clamps	External magnetic field	Additional uncertainty
Flex clamp (A1487)	5 A/m	±(15 % of reading)

- It is very important that the conductor is at the center and perpendicular to the measuring head.
- Full-scale value of the Flex current (If1, If2, If3, If4) depends on the number of turns of the Flex clamp (1, 2, 3, 4, 5, 6) and is defined according to the following equation:

$$I_{f_{FS}} = \frac{49,9[A]}{\text{number of turns}}$$

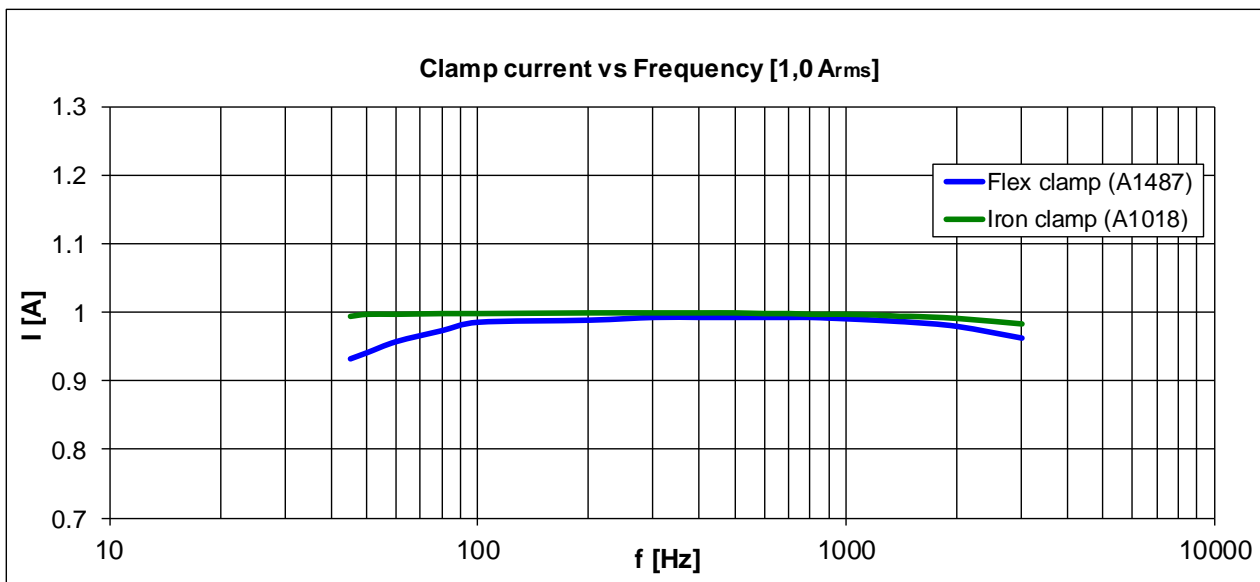

15.8 Influence of the auxiliary electrodes

Definition of Rc, Rp and Ra:

- Rc Impedance of auxiliary current probes (Rh + Re)
- Rp Impedance of auxiliary potential probes (Rs + Res)
- Ra Earth resistance

**Measurement function..... 3, 4 – pole, Selective (Iron, Flex Clamp),
Wenner and Schlumberger method,
HF Earth Resistance (25 kHz)**

Additional uncertainty if limit (Rh, Rs, Res, Re) or max. value are exceeded (whichever is lower).

Test frequency	Limit for Rh and Rs	Limit for Res and Re	max. value	Additional uncertainty
55 Hz ... 164 Hz	$> 100 \Omega + (2 \text{ k} * Ra)$	$> 100 \Omega + (1 \text{ k} * Ra)$	50 kΩ	±(15 % of reading)
329 Hz ... 659 Hz	$> 100 \Omega + (1 \text{ k} * Ra)$	$> 100 \Omega + (500 * Ra)$	25 kΩ	±(15 % of reading)
1,31 kHz ... 2,63 kHz	$> 100 \Omega + (500 * Ra)$	$> 50 \Omega + (250 * Ra)$	12,5 kΩ	±(15 % of reading)
3,29 kHz ... 6,59 kHz	$> 100 \Omega + (250 * Ra)$	$> 50 \Omega + (125 * Ra)$	6,25 kΩ	±(15 % of reading)
13,1 kHz ... 15,0 kHz	$> 50 \Omega + (150 * Ra)$	$> 50 \Omega + (50 * Ra)$	3,1 kΩ	±(15 % of reading)
25,0 kHz	$> 250 \Omega + (500 * Ra)$	/	2 kΩ	±(15 % of reading)

If the auxiliary probes limit is exceeded by an additional 50 % then the measuring range of the instrument is exceeded.

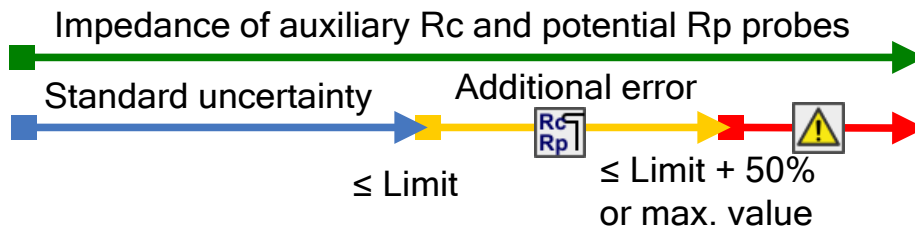

	The measuring range of the instrument is exceeded. Measurement could not be started or displayed!
--	---

Notes:

- High impedance of auxiliary current or potential probes icon.

	High impedance of auxiliary current and potential probes.
	High impedance of auxiliary current probe Rc.
	High impedance of auxiliary potential probe Rp.

15.9 Influence of low test current through clamps

In large systems the measured partial current is only a small portion of the test current through the current clamp. The measuring uncertainty for small currents of and immunity against noise currents must be considered. The tester displays the “low current icon” warning in this case.

	Low test current through Iron or Flex clamps. Results may be impaired. <i>Limit [Iron clamps < 1 mA and Flex clamps < 5 mA].</i>
---	---

Measurement function..... **Selective (Iron, Flex Clamp), 2 Clamps, Passive, Pylon Ground Wire Test (PGWT), Flex and Iron Clamp Meter RMS**

Clamps	Additional uncertainty if low current limit is exceeded		
	Index	Limit	Additional uncertainty
Iron clamp (A1018)	Ic	< 1 mA	±(10 % of reading + 2 digits)
Flex clamp (A1487)	If1, If2, If3, If4	< 5 mA (* See Notes)	±(10 % of reading + 3 digits)

If the low current limit is exceeded by an additional 70 % [Ic < 0,3 mA and If1-4 < 1,5 mA] then the main measuring result is disabled.

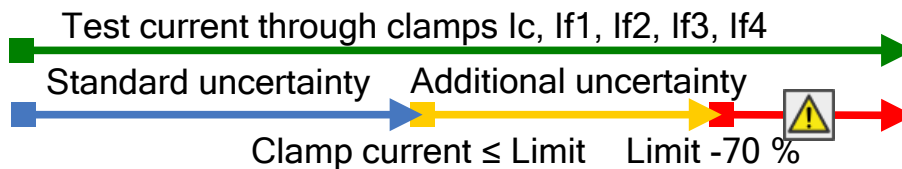

	The measuring range of the instrument is exceeded. Measurement could not be started or displayed!
---	---

Notes:

- When using only one, two or three flex clamps, always connect one clamp to F1 terminal (synchronization port).

	F1 - Flex clamp 1 input terminal (Synchronization port) is not connected to the instrument. Always connect one clamp to F1 terminal.
---	--

- Make sure that the number of turns is correctly entered in the test parameters window.

$$\text{limit } I_f_{1,2,3,4} = \frac{5,0[mA]}{\text{number of turns}}$$

- Make sure that the arrow marked on the clamp coupling, points toward the correct orientation for correct phase measurement.

	Negative current through flex clamps; check the right direction of the Flex clamps [↑ ↓].
---	---

 Selective	Negative current through flex clamps If2 and If4 (marked with -).
If1 10.3 mA	
If2 -10.2 mA	
If3 84.9 mA	
If4 -10.3 mA	

15.10 Influence of noise

Definition of noise:

Injection of series interference (voltage / current) with system frequencies of: 16 2/3 Hz, 50 Hz, 60 Hz, 400 Hz or d.c. (frequencies by IEC 61557-5).

**Measurement function..... 2, 3, 4 – pole, Selective (Iron, Flex Clamp),
Wenner and Schlumberger method,
HF Earth Resistance (25 kHz), Potential ratio**

Max noise interference voltage

on terminals H, S, ES and E..... 40 V rms

Max noise interference current through:

Flex clamps (A1487)..... 30 A rms (One turn)

Iron clamp (A1018)..... 5 A rms

Max external magnetic field..... 100 A/m (No influence)

Injected noise frequency	Test frequency	Noise rejection (* See note)
400 Hz	55 Hz ... 15,0 kHz	> 80 dB
60 Hz	55 Hz	> 50 dB
	82 Hz ... 15,0 kHz	> 80 dB
50 Hz	55 Hz	> 50 dB
	82 Hz ... 15,0 kHz	> 80 dB
16 2/3 Hz	55 Hz ... 15,0 kHz	> 80 dB
d.c.	55 Hz ... 15,0 kHz	> 80 dB

Measurement function..... 2 Clamps

Max noise interference current through:

Iron clamp (A1018) 5 A rms (Re < 20Ω)
1 A rms (Re > 20Ω)

Max external magnetic field..... 100 A/m (No influence)

Notes:

- Noise injection examples (voltage / current)

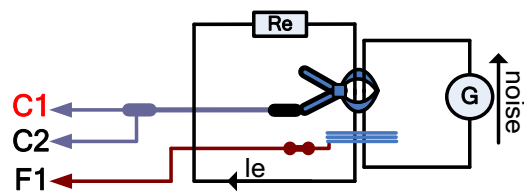
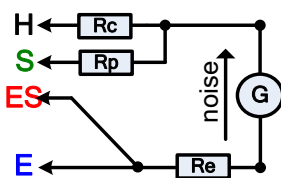

- Noise icon

	High electrical noise was detected during measurement. Results may be impaired. <i>Limit [Noise frequency is close (±6 %) to the test frequency].</i>
--	--

- To high input measuring signals on terminals H, S, ES, E, Clamp, F1, F2, F3 or F4. Possible reasons: max noise interference voltage or current have been reached; check the number of turns on flex clamps.

	The measuring range of the instrument is exceeded. Measurement could not be started or displayed!
--	---

- Signal-to-noise ratio

$$SNR_{db} = 20 * \log_{10} \left(\frac{A_{SIGNAL}}{A_{NOISE}} \right)$$

15.11 Sub-results in measurement functions

Sub-result	Measuring range	Resolution	Uncertainty
Rp, Rc	0 Ω ... 49,9 k Ω	1 Ω ... 0,1 k Ω	$\pm(8\%$ of reading + 3 digits)
Re	0,01 Ω ... 19,9 k Ω	0,01 Ω ... 0,1 k Ω	$\pm(8\%$ of reading + 3 digits)
Ie	0,01 mA ... 999 mA	0,01 mA ... 1 mA	$\pm(3\%$ of reading + 3 digits)
Ic	0,01 mA ... 9,99 A	0,01 mA ... 0,01 A	$\pm(5\%$ of reading + 3 digits)
Us	0,01 V ... 49,9 V	0,01 V ... 0,1 V	$\pm(1\%$ of reading + 3 digits)
If1, If2, If3, If4	0,1 mA ... 49,9 A	0,1 mA ... 0,1 A	$\pm(5\%$ of reading + 3 digits)
Zsel1, Zsel2, Zsel3, Zsel4	0,1 Ω ... 19,9 k Ω	0,1 Ω ... 0,1 k Ω	$\pm(8\%$ of reading + 3 digits)
f	40,0 Hz ... 25,0 kHz	0,1 Hz ... 0,1 kHz	$\pm(0,2\%$ of reading + 1 digit)
Igen	0,01 mA ... 999 mA	0,01 mA ... 1 mA	$\pm(2\%$ of reading + 2 digits)
If_sum	0,01 mA ... 99,9 A	0,01 mA ... 0,1 mA	$\pm(5\%$ of reading + 3 digits)
Uh, Us, Ues	0,01 V ... 49,9 V	0,01 V ... 0,1 V	$\pm(1\%$ of reading + 3 digits)
Iac	0,1 mA ... 999 mA	0,1 mA ... 1 mA	$\pm(2\%$ of reading + 2 digits)
R, X	1 Ω ... 19,9 k Ω	1 Ω ... 0,1 Ω	Indication only
φ	1° ... 360°	1°	Indication only
Idc	0,1 mA ... 999 mA	0,1 mA ... 1 mA	$\pm(2\%$ of reading + 2 digits)

15.12 General data

Battery power supply	14,4 V DC (4,4 Ah Li-ion)
Battery charging time	typical 4,5 h (deep discharge)
Mains power supply	90-260 V _{AC} , 45-65 Hz, 100 VA
Over-voltage category	300 V CAT II

Battery operation time:

Idle state	> 24 h
Measurements	> 8 h continuous testing 4 - pole, R _c < 2 kΩ
Auto - off timer	10 min (idle state)

Protection classification	reinforced insulation 
Measuring category	300 V CAT IV

Pollution degree	2
Degree of protection	IP 65 (case closed), IP 54 (case open)

Dimensions (w × h × d)	36 cm x 16 cm x 33 cm
Weight	6,0 kg, (without accessories)

Sound / Visual warnings	yes
Display	4.3" (10.9 cm) 480 × 272 pixels TFT colour display with touch screen

Reference conditions:

Reference temperature range	25 °C ± 5 °C
Reference humidity range	40 %RH ... 60 %RH

Operation conditions:

Working temperature range	-10 °C ... 50 °C
Maximum relative humidity	90 %RH (0 °C ... 40 °C), non-condensing
Working nominal altitude	up to 3000 m

Storage conditions:

Temperature range	-10 °C ... 70 °C
Maximum relative humidity	90 %RH (-10 °C ... 40 °C) 80 %RH (40 °C ... 60 °C)

USB communication:

USB slave communication	galvanic separated
Baud rate	115200 bit/s
Connector	standard USB connector - type B

Bluetooth communication:

Device pairing code:	NNNN
Baud rate:	115200 bit/s
Bluetooth module	class 2

Data:

Memory	>1 GBit
PC software	yes

Specifications are quoted at a coverage factor of $k = 2$, equivalent to a confidence level of approximately 95 %.

Accuracies apply for 1 year in reference conditions. Temperature coefficient outside these limits is 0,2 % of measured value per °C, and 1 digit.

Appendix A – Structure objects

Structure elements used in Memory Organizer are instrument's Profile dependent.

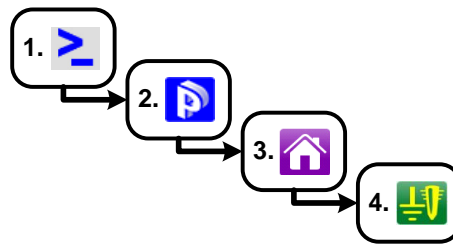









Figure A.1: Memory organizer hierarchy

Symbol	Default name	Parameters:
	Node	/
	Project	name of project, description of project;
	Building	name, description, location, type, nominal power, nominal voltage;
	Sub-Station	name, description, location, type, nominal power, nominal voltage;
	Power Station	name, description, location, type, nominal power;
	Transmission Tower	name, description, location, type, material type, nominal power, nominal voltage;
	Public Lighting	name, description, location, material type, nominal voltage;
	Transformer	name, description, location, nominal power, nominal voltage;
	Lightning Rod	name, description, location;
	Grounding Rod	name, description, location;
	Mesh	name, description, location;
	Fence	name, description, location;
	Pipe	name, description, location;

Appendix B – Profiles Selection Table

Available profiles and measurement functions for the Earth Analyser:

Measurement functions available		Profile Code Name	ARAB MI 3290 GF	ARAA MI 3290 GL	ARAC MI 3290 GP	ARAD MI 3290 GX
Group	Icon					
2 - pole	Earth		•	•	•	•
3 – pole	Earth		•	•	•	•
4 – pole	Earth		•	•	•	•
Selective (Iron Clamp)	Earth			•		•
2 Clamps	Earth			•		•
HF-Earth Resistance (25 kHz)	Earth			•		•
Selective (Flex Clamps 1 - 4)	Earth				•	•
Passive (Flex Clamps 1 - 4)	Earth				•	•
Wenner method	Specific		•	•	•	•
Schlumberger method	Specific		•	•	•	•
Impulse Measurement	Pulse			•		•
Ω - Meter (200 mA)	DC R		•			•
Ω - Meter (7 mA)	DC R		•			•
Impedance Meter	AC Z		•			•
Potential	Potential		•			•
S&T Current Source	Potential		•			•
Pylon Ground Wire Test	Test				•	•
Iron Clamp Meter RMS	Current			•		•
Flex Clamp Meter RMS	Current				•	•
Check V-Meter	CheckBox		•	•	•	•
Check A-Meter	CheckBox		•	•	•	•
Check Iron, Flex Clamps	CheckBox			•	•	•
						

Appendix C – Functionality and placing of test probes

For a standard earthing resistance two test probes (voltage and current) are used. Because of the voltage funnel it is important that the test electrodes are placed correctly. More information about principles described in this document can be found in the handbook: *Grounding, bonding, and shielding for electronic equipment and facilities*.

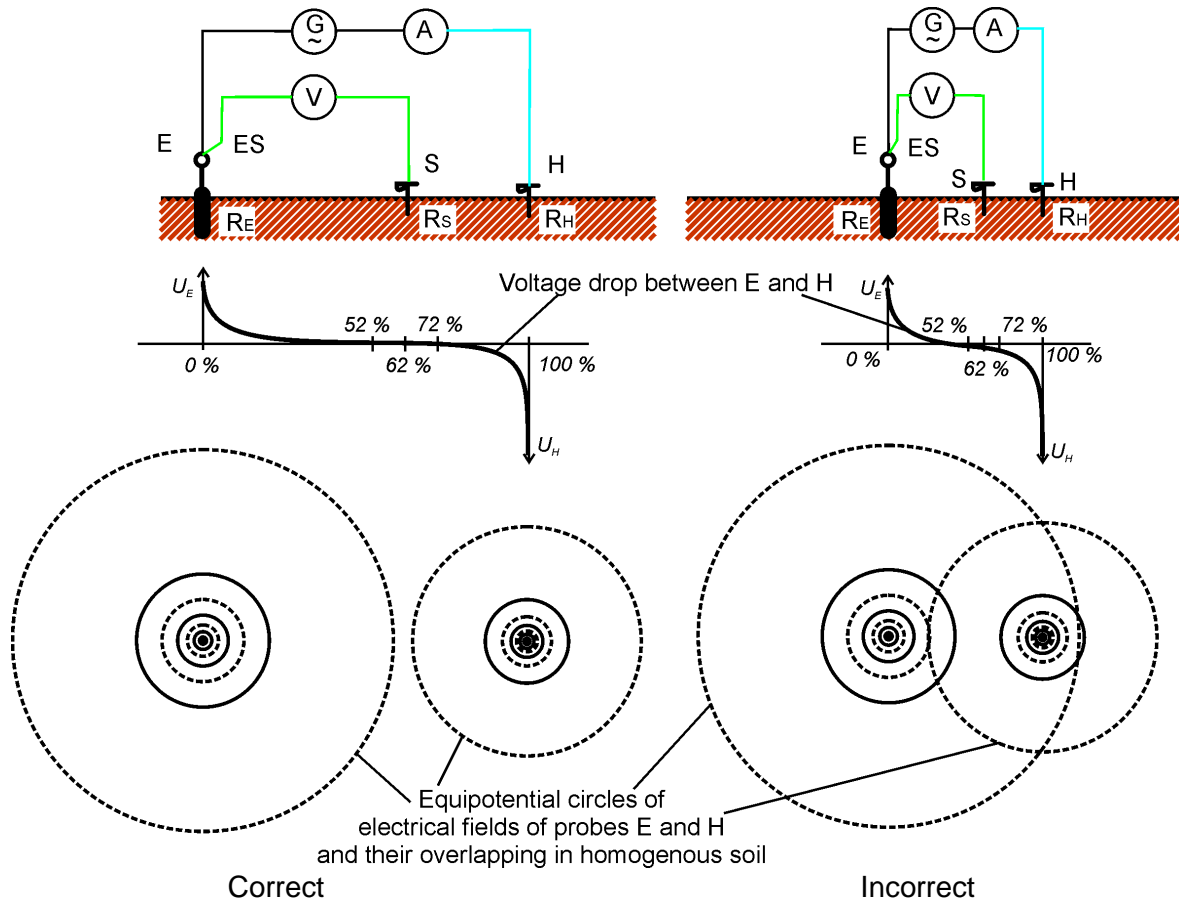

Figure C.1: Placement of probes

Probe E is connected to the earthing electrode (rod).

Probe H serves to close the measuring loop. The voltage between probe S and E is the voltage drop on the measured resistance. Correct placing of probes is essential. If the S probe is placed too close to the earthing system, then too small resistance will be measured (only a part of the voltage funnel would be seen).

If the S probe is placed too close to the H probe the earthing resistance of voltage funnel of the H probe would disturb the result.

It is important that the size of the earthing system is known, for the correct test probe placement. Parameter **a** represents the maximum dimension of the earthing electrode (or a system of electrodes) and can be defined acc. to Figure C.2.

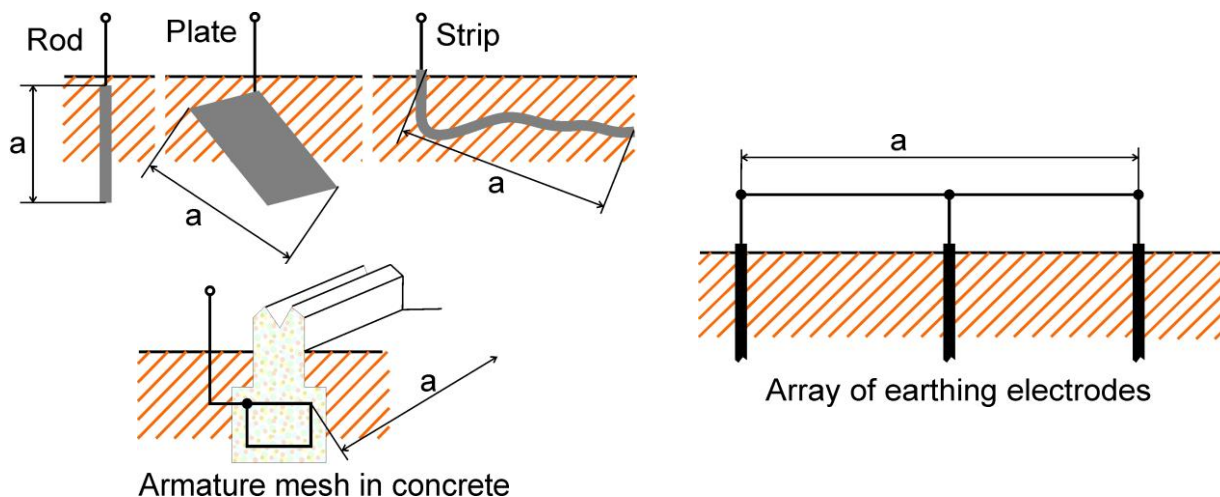

Figure C.2: Definition of parameter a

Straight-line placement

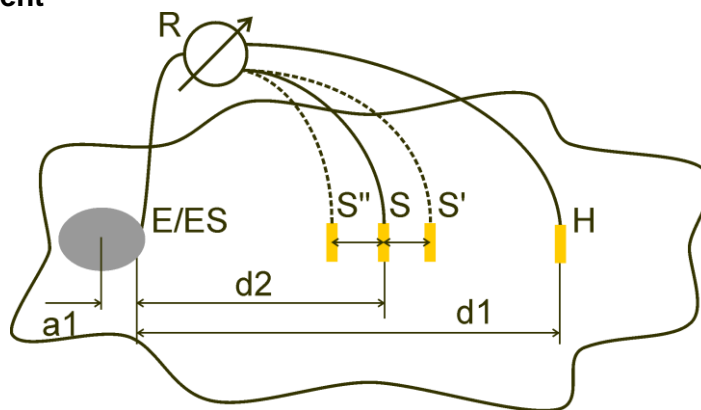

Figure C.3: Straight-line placement

After the maximum dimension **a** of an earthing system is defined then measurements can be performed by proper placement of test probes. A measurement with three placements of test probe S (S'', S, S') is intended to verify that the selected distance **d1** is long enough.

- Distance from tested earthing electrode system E/ES to current probe H shall be:

$$d_1 \geq 5a$$

- Distance from tested earthing electrode system E/ES to potential probe S shall be:

$$d_2 = 0,62d_1 - 0,38a_1 [\Omega]$$

a1.....distance between connection point of earthing system and center.

Measurement 1

- Distance from earthing electrode E/ES to voltage probe S shall be:

$$d_2$$

Measurement 2

- Distance from earthing electrode E/ES to voltage probe S shall be:

$$d_2 = 0,52d_1 - 0,38a_1(S'')$$

Measurement 3

- Distance from earthing electrode E/ES to voltage probe S shall be:

$$d_2 = 0,72d_1 - 0,38a_1(S')$$

In case of a properly selected d_1 the result of measurements 2 and 3 are symmetrical around the result of measurement 1. The differences (measurement 2- measurement 1, measurement 3 - measurement 2) must be lower than 10 %. Higher differences or non-symmetric results mean that the voltage funnels influence the measurement and the d_1 should be increased.

Notes:

- Initial uncertainty of measured resistance to earth depends on distance between electrodes d_1 and size of earthing electrode a . It can be seen in Table C.4.

d_1/a	Uncertainty [%]
5	10
10	5
50	1

Table C.4: Influence of d_1/a ratio to initial uncertainty

- It is advisable for the measurement to be repeated at different placements of test probes.
- The test probes shall also be placed in the opposite direction from tested electrode (180° or at least 90°). The final result is an average of two or more partial results.
- According to IEC 60364-6 the distances $S'-S$ (measurement 2) and $S''-S$ (measurement 3) shall be 6 m.

Equilateral placement

Figure C.5: Equilateral placement

Measurement 1

Distance from tested earthing electrode to current probe H and voltage probe S should be at least:

$$d_2 = 5 \cdot a$$

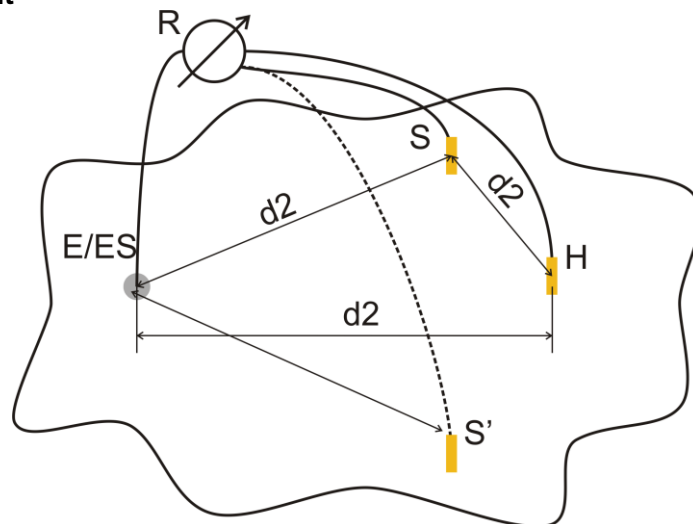
Measurement 2

Distance from earthing electrode to voltage probe S (S'):
d2, contrary side regarding to H

The first measurement is to be done at the S and H probes placed at a distance of d2. Connections E, probes H and S should form a equilateral triangle.

For the second measurement the S probe should be placed at the same distance d2 on the contrary side regarding to the H probe. Connections E, probes H and S should again form a equilateral triangle. The difference between both measurements shall not exceed 10%. If a difference in excess of 10% occurs, distance d2 should be proportionally increased and both measurements repeated. A simple solution is only to exchange test probes S and H (can be done at the instrument side). The final result is an average of two or more partial results.

It is advisable for the measurement to be repeated at different placements of test probes. The test probes shall be placed in the opposite direction from tested electrode (180° or at least 90°).

Test probe resistances

In general test probes should have a low resistance to earth. In case the resistance is high (usually because of dry soil) the H and S probes can significantly influence the measurement result. A high resistance of H probe means that most of the test voltage drop is concentrated at the current probe and the measured voltage drop of the tested earth electrode is small. A high resistance of S probe can form a voltage divider with the internal impedance of the test instrument resulting in a lower test result. Test probe resistance can be reduced by:

- ❑ Watering in the vicinity of probes with normal or salty water.
- ❑ Depleting electrodes under dried surface.
- ❑ Increasing test probe size or paralleling of probes.

METREL test equipment displays appropriate warnings in this case, according to IEC 61557-5. All METREL Earth testers measure accurate at probe resistances far beyond the limits in IEC 61557-5.

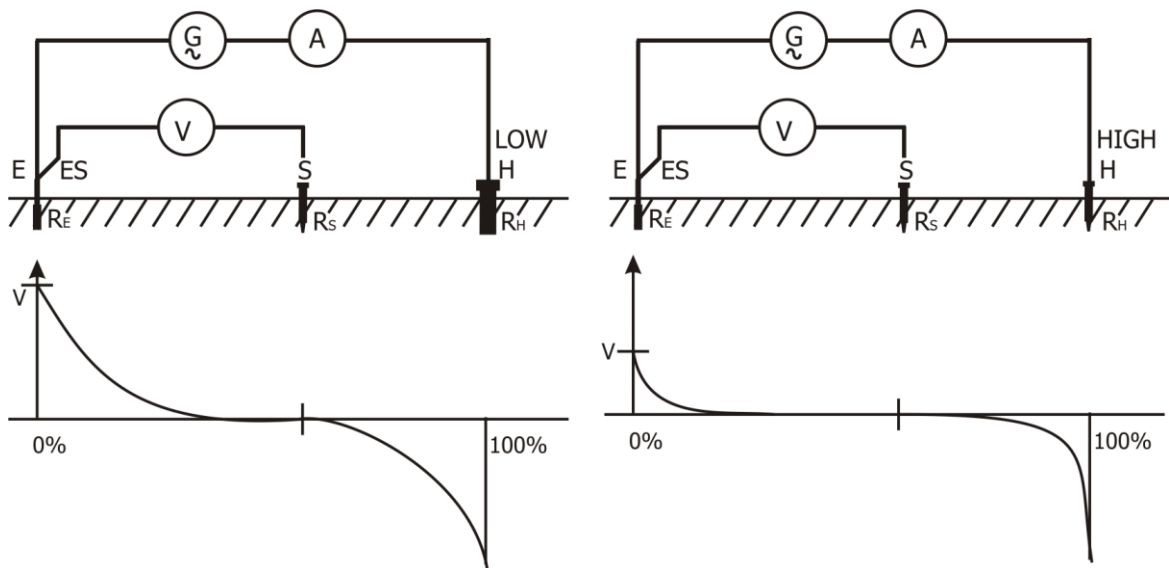
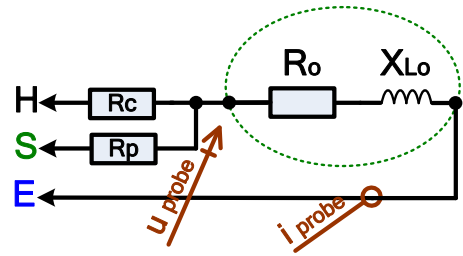

Figure C.6: Different measured voltage drops at low and high probe resistance

Appendix D – Pulse and 3-pole example

Test objects description and schematics wiring diagram:

Test Object	Ro	Lo	Rc	Rp
Re1	1 Ω	1 μH	50 Ω	200 Ω
Re2	1 Ω	25 μH	50 Ω	200 Ω
Re3	1 Ω	55 μH	50 Ω	200 Ω
Re4	1 Ω	376 μH	50 Ω	200 Ω



Impulse measurement results:

Impulse [Zp]	Re1	Re2	Re3	Re4
10/350 μs	1,0 Ω	1,1 Ω	2,0 Ω	12,6 Ω

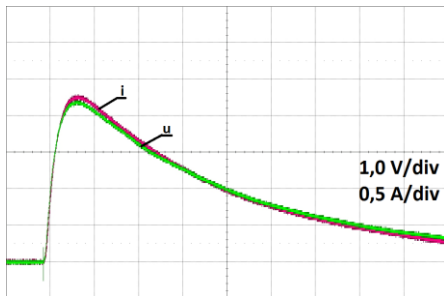

Figure D.1: Oscilloscope screenshot Re1

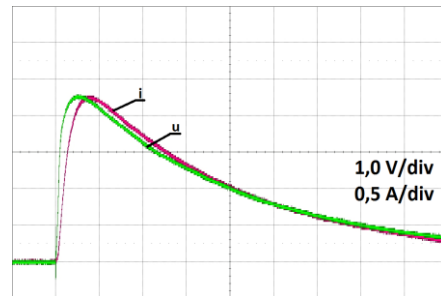

Figure D.2: Oscilloscope screenshot Re2

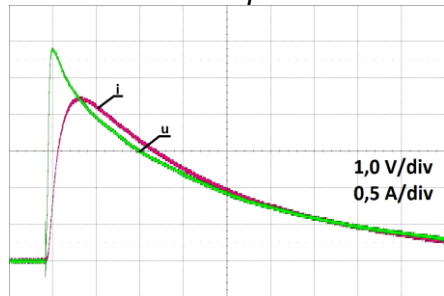

Figure D.3: Oscilloscope screenshot Re3

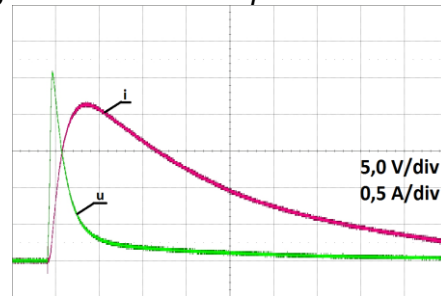
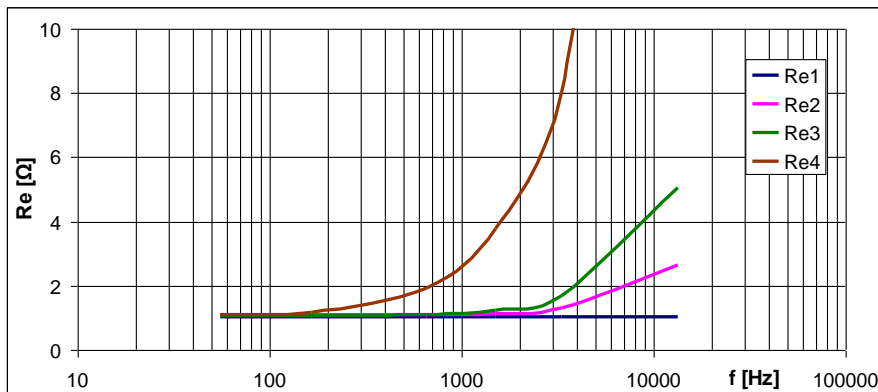

Figure D.4: Oscilloscope screenshot Re4

3- pole measurement results:

3 –pole [Re]					Calculated impedance value			
Test Frequency	Re1	Re2	Re3	Re4	Re1	Re2	Re3	Re4
55 Hz	1,04 Ω	1,10 Ω	1,08 Ω	1,11 Ω	1,0 Ω	1,0 Ω	1,0 Ω	1,0 Ω
164 Hz	1,04 Ω	1,11 Ω	1,08 Ω	1,17 Ω	1,0 Ω	1,0 Ω	1,0 Ω	1,1 Ω
660 Hz	1,04 Ω	1,11 Ω	1,11 Ω	1,93 Ω	1,0 Ω	1,0 Ω	1,0 Ω	1,8 Ω
1,5 kHz	1,04 Ω	1,15 Ω	1,24 Ω	3,78 Ω	1,0 Ω	1,0 Ω	1,1 Ω	3,7 Ω
3,29 kHz	1,04 Ω	1,30 Ω	1,70 Ω	8,02 Ω	1,0 Ω	1,1 Ω	1,5 Ω	7,8 Ω
13,3 kHz	1,04 Ω	2,63 Ω	5,04 Ω	31,5 Ω	1,0 Ω	2,3 Ω	4,7 Ω	31,4 Ω



Appendix E - Programming of Auto tests on Metrel ES Manager

The Auto test editor is a part of the Metrel ES Manager software. In Auto test editor Auto tests can be pre-programmed and organized in groups, before uploaded to the instrument.

I. Auto test editor workspace

To enter Auto test editor's workspace, select  in Home Tab of Metrel ES Manager PC SW. Auto test editor workspace is divided in four main areas. On the left side **1**, structure of selected group of Auto tests is displayed. In the middle part of the workspace **2**, the elements of the selected Auto test are shown. On the right side, list of available single tests **3** and list of flow commands **4** are shown.

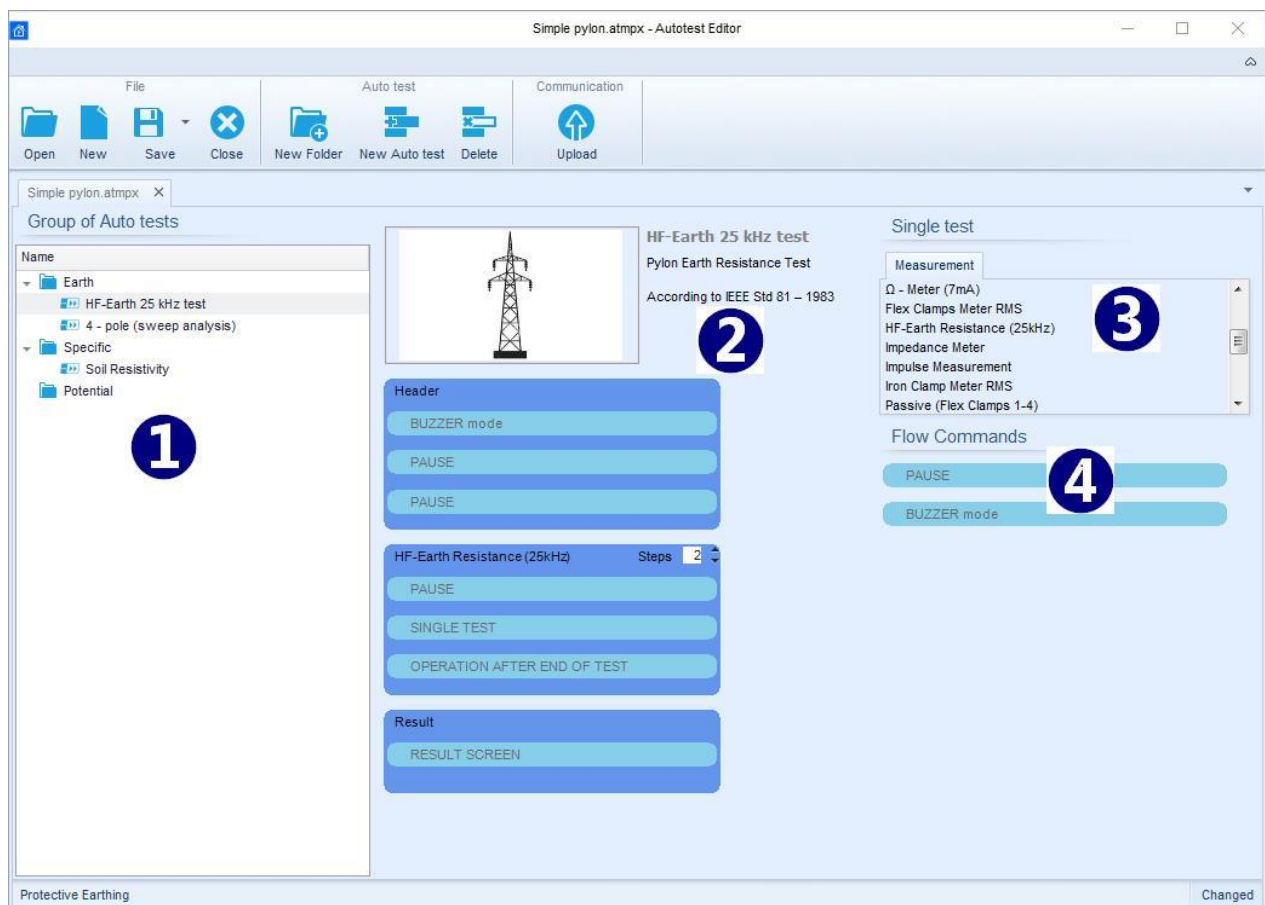

Figure E.1: Auto tests editor workspace

An Auto test sequence **2** begins with Name, Description and Image, followed by the first step (Header), one or more measuring steps and ends with the last step (Result). By inserting appropriate Single tests **3** and Flow commands **4** and setting their parameters, arbitrary Auto test sequences can be created.

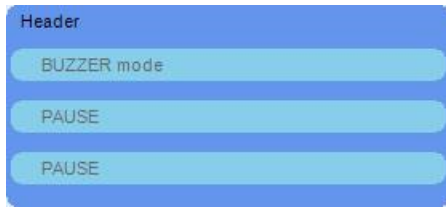

Figure E.2: Example of an Auto test header

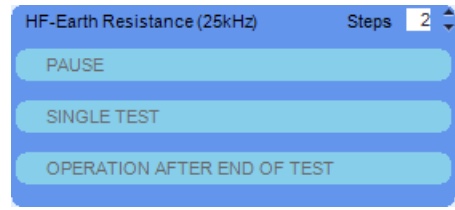

Figure E.3: Example of a measurement step

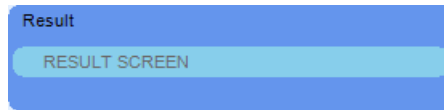

Figure E.4: Example of an Auto test result part

II. Managing groups of Auto tests

The Auto tests can be divided into different user defined groups of Auto tests. Each group of Auto tests is stored in a file. More files can be opened simultaneously in Auto test editor. Within Group of Auto tests, tree structure can be organized, with folders / subfolders containing Auto tests. The three structure of currently active Group of Auto tests is displayed on the left side of the Auto test editor workspace, see Figure E.5..

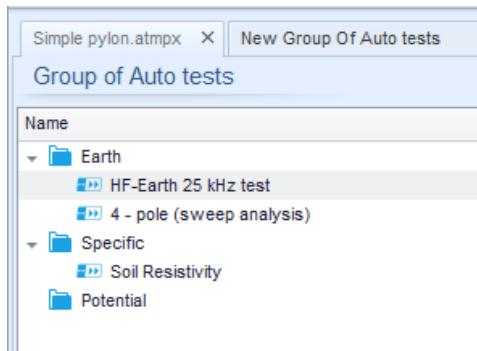





Figure E.5: Group of Auto tests tree organization

Operation options on Group of Auto tests are available from menu bar at the top of Auto test editor workspace.

File operation options:



-  Opens a file (Group of Auto tests).

-  Saves / Saves as the opened Group of Auto tests to a file.





-  Creates a new file (Group of Auto tests).

-  Closes the file (Group of Auto tests).



Group of Auto tests operation options (also available by right clicking on Folder or Auto test):

- 
Adds a new folder / subfolder to the group
- 
Adds a new Auto test to the group.
- 
Deletes:
the selected Auto test
the selected folder with all subfolders and Auto tests



Right click on the selected Auto test or Folder opens menu with additional possibilities:

- 
Auto test: Edit Name, Description and Image (see Figure E.6).
Folder: Edit folder name
- 
Auto test: Copy to clipboard
Folder: Copy to clipboard including subfolders and Auto tests
- 
Auto test: Cut it to clipboard
Folder: Cut it to clipboard together with all subfolders and all Auto tests
- 
Auto test: Paste it to selected location
Folder: Paste it to selected location

Double click on the object name allows name edit:

DOUBLE CLICK	<p>Auto test name: Edit Auto test name </p> <p>Folder name: Edit folder name </p>
-------------------------	---

Drag and drop of the selected Auto test or Folder / Subfolder moves it to a new location:

DRAG & DROP	<p>“Drag and drop” functionality is equivalent to “cut” and “paste” in a single move.</p> <p> move to folder</p> <p> insert</p>
----------------------------	---

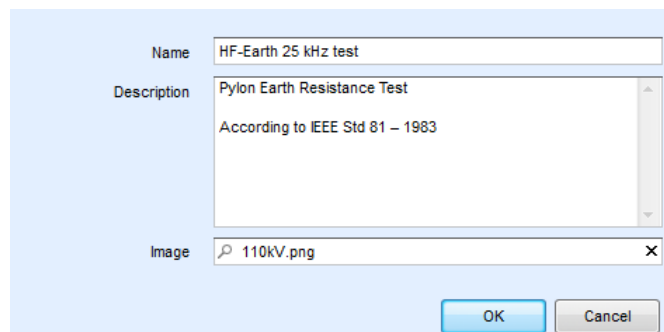

Figure E.6: Editing the Auto test header

III. Elements of an Auto test

Auto test steps

There are three kinds of Auto test steps.

Header

The Header step is empty by default.

Flow commands can be added to the Header step.

Measurement step

The Measurement step contains a Single test and the Operation after end of test flow command by default. Other Flow commands can also be added to the Measurement step.

Result

The Result step contains the Result screen flow command by default. Other Flow commands can also be added to the Result step.

Single tests

Single tests are the same as in Metrel ES Manager Measurement menu.

Limits and parameters of the measurements can be set. Results and sub-results can't be set.

Flow commands

Flow commands are used to control the flow of measurements. Refer to chapter Description of flow commands for more information.



Number of measurement steps

Often the same measurement step has to be performed on multiple points on the device under test. It is possible to set how many times a Measurement step will be repeated. All carried out individual Single test results are stored in the Auto test result as if they were programmed as independent measuring steps.

IV. Creating / modifying an Auto test

If creating a new Auto test from scratch, the first step (Header) and the last step (Result) are offered by default. Measurement steps are inserted by the user.

Options:

Adding a measurement step	By double clicking on a Single test a new measurement step will appear as the last of measurement steps. It can also be dragged and dropped on the appropriate position in the Auto test.
Adding flow commands	Selected flow command can be dragged from the list of Flow commands and dropped on the appropriate place in any Auto test step.
Changing position of flow command inside one step	By a click on an element and use of  ,  keys.
Viewing / changing parameters of flow commands or single tests.	By a double click on the element.
Setting number of measurement steps	By setting a number from 1 to 20 in the  field.

Right click on the selected measurement step / flow command

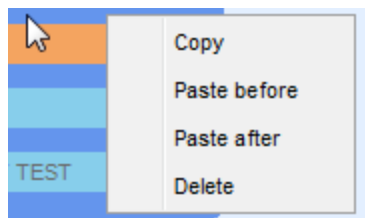

Copy – Paste before
 A measurement step / flow command can be copied and pasted above selected location on the same or on another Auto test.

Copy – Paste after
 A measurement step / flow command can be copied and pasted under selected location on the same or on another Auto test.

Delete
 Deletes the selected measurement step / flow command.

V. Description of flow commands

Double click on inserted Flow Command opens menu window, where text or picture can be entered, external signaling and external commands can be activated and parameters can be set. Flow commands Operation after end of test and Results screen are entered by default, others rest of them are user selectable from Flow Commands menu.

Pause

A Pause command with text message or picture can be inserted anywhere in the measuring steps. Warning icon can be set alone or added to text message. Arbitrary text message can be entered in prepared field Text of menu window.

Parameters:

Pause type Show text and/or warning check to show warning icon

Show picture browse for image path

Duration Number in seconds, infinite no entry

Buzzer mode

Passed or failed measurement is indicated with beeps.

- Pass – double beep after the test
- Fail – long beep after the test

Beep happens right after single test measurement.

Parameters:

State On – enables Buzzer mode
 Off – disables Buzzer mode

Operation after end of test

This flow command controls the proceeding of the Auto test in regard to the measurement results.

Parameters:

Operation after end of test	The operation can be individually set for the case the measurement passed, failed or ended without a status.
– pass	
– fail	
– no status	
	Manual – The test sequence stops and waits for appropriate command (Enter key) to proceed.
	Auto – The test sequence automatically proceeds.
