



TREND NETWORKS



LanTEK IV

The Future of Cable
Certification

User Manual

Depend On Us

LanTEK IV

User Manual

© **TREND NETWORKS 2020**

The information contained in this document is the property of TREND NETWORKS and is supplied without liability for errors and omissions. No part of this document may be reproduced or used except as authorized by contract or other written permission from TREND NETWORKS. The copyright and all restrictions on reproduction and use apply to all media in which this information may be placed. TREND NETWORKS pursues a policy of continual product improvement and reserves the right to alter without notice the specification, design, price or conditions of supply of any product or service. All rights reserved.

TREND NETWORKS
Stokenchurch House
Oxford road
Stokenchurch
High Wycombe
Buckinghamshire
HP14 3SX
United kingdom

Content

Safety Instructions	4
Responsibilities	5
Certification Link Models	6
TREND AnyWARE Cloud	8
LanTEK IV Configuration: Settings Menu	11
Default Autotest Settings	12
Wi-Fi Settings	13
Importing/Exporting Jobs	14
User Interface Operating Modes	15
Standard User Interface Operation - explained	16
Live Wiremap	23
Creating Test Files	24
Presentation of Tests	37
Performing Tests	39
Display of Test Results	41
Test List Options	47
Filtering Display of Test Results	49
Jobs Management and Synchronization	51
Folder Management and Synchronization	54
Technical Specifications of Cable Certifiers	56

Safety instructions

Warnings for handling the rechargeable batteries of LanTEK IV.

All Lithium-Ion (Li-Ion) batteries generate a significant flow of electric current, irrespective of the indicated state of charge, which can cause personal injury and / or property damage.

Lithium ion (Li-Ion) batteries should not be burned or disposed of with normal waste. Lithium-ion (Li-Ion) batteries can explode if exposed to flame. Rechargeable batteries are special waste and can contaminate groundwater if not disposed of properly.

Automatic resetting fuses in rechargeable batteries, which cut off high current discharge as quickly as possible, ensure the greatest possible safety. However, these fuses cannot provide full protection against transient arc discharges, which can occur through a short circuit of the electrical contacts in the rechargeable battery. To avoid injury, the following instructions for handling rechargeable batteries must be observed.

When a rechargeable battery is not installed in the tester handser, it must be stored in clean, dry and non-conductive packaging.

Take care that the contacts of the rechargeable battery do not touch conductive materials.

Avoid touching the contact surfaces of the rechargeable battery.

Rechargeable batteries can be recharged when they are in the tester or by the external charging port with the provided power supply. Charging the rechargeable battery in any other way may cause it to explode.

Rechargeable batteries should only be placed, transported, stored and charged in a non-explosive environment.

Observe service and storage temperatures.

Do not leave children or people who are not familiar with the safety instructions in this user manual, handle or charge the rechargeable batteries.

Do not open the rechargeable battery case. No part in the case needs to be serviced by the customer; rechargeable batteries cannot be repaired.

Responsibilities

TREND NETWORKS is not responsible for death, personal injury, device damage or property damage caused by improper use of rechargeable batteries.

TREND NETWORKS is not responsible for consequential damages caused by modifications of the rechargeable batteries or the charger and their subsequent use.

Subject to technical changes.

If you have any questions regarding these safety instructions, this user manual, or any doubts regarding the safe handling and disposal of the rechargeable batteries used in the LanTEK®IV cable certifier, please contact a TREND NETWORKS representative.

Work with LanTEK®IV cabling certifier

The default parameter settings in the LanTEK®IV cable certifier are based on general standards and recommended standards as well as the habits of the installation and maintenance worlds; and the expertise of TREND NETWORKS.

TREND NETWORKS recommends before testing commences, to define precisely with the end customer or with the team leader, or design office, the cabling standard to which certification must be carried out, to ensure that the parameters tested meet the expected requirements.

Indications

The following symbols used in this user manual indicate that the user must proceed with great caution, in order to avoid injury to persons or damage to the LanTEK®IV wiring certifier or the system tested.



WARNING !

This symbol indicates life-threatening voltages. There is a danger of death and / or for the health of the person carrying out the action or of persons in the vicinity.



CAUTION!

This symbol indicates that the action concerned may possibly threaten the environment or damage technical equipment.

Typographic conventions

Bold: indicates a key from the LanTEK®IV cabling certifier.

Italicized characters: indicates menu option in this user manual

Quotation marks "": indicates a "message on the screen".

Certification Link Models

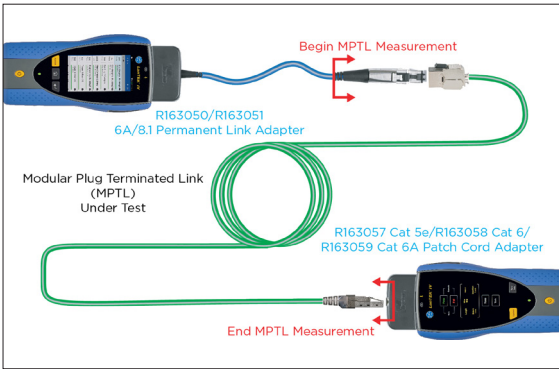

MPTL (Modular Plug Terminated Link) configuration

Included in the test:

- Connection between the Permanent link adapter plug and the MPTL socket
- Connection between MPTL plug and patch cord adapter

Not included in the test:

- Permanent link adapter cord

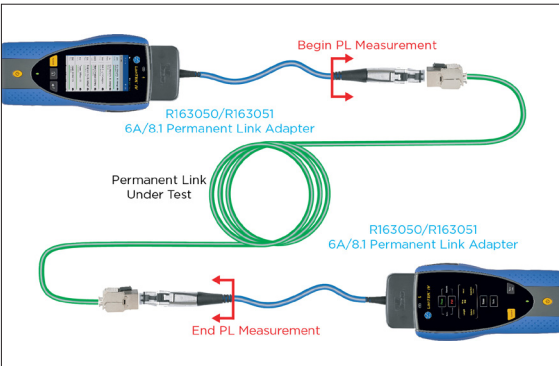

Permanent Link configuration

Included in the test:

- Connection between the permanent link adapter plug and the permanent link wiring

Not included in the test:

- Permanent link adapter cord

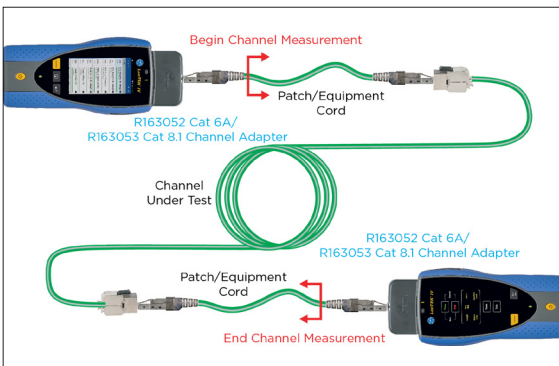

Channel Configuration

Included in the test:

- The patch cord wire
- Connection between RJ45 plug and permanent link wiring

Not included in the test:

- Connections between the 2 patch cords plug and channel adapters

Certification Link Models

The typical method is the Permanent Link to certify the infrastructure fixed wiring consisting of two female RJ45 sockets at each end and an optional consolidation point connector near the work area.

The Channel method has the advantage of also certifying the two patch cords connected to the permanent link thus measuring the entire channel from end-to-end. The downside is that if the patch cords are changed, the channel must be re-certified.

The MPTL method makes it possible to certify a hybrid link consisting of a conventional female socket on one side and a male connector (plug) at the other side. MPTL's are used to directly connect to a PoE camera, Wi-Fi access point, access control and other devices that are installed in fixed locations. To certify an MPTL a Permanent link adapter is attached to the main handset and a patch cord adapter on the remote handset. The patch cord adapter must be of the same category rating as the components of the MPTL.

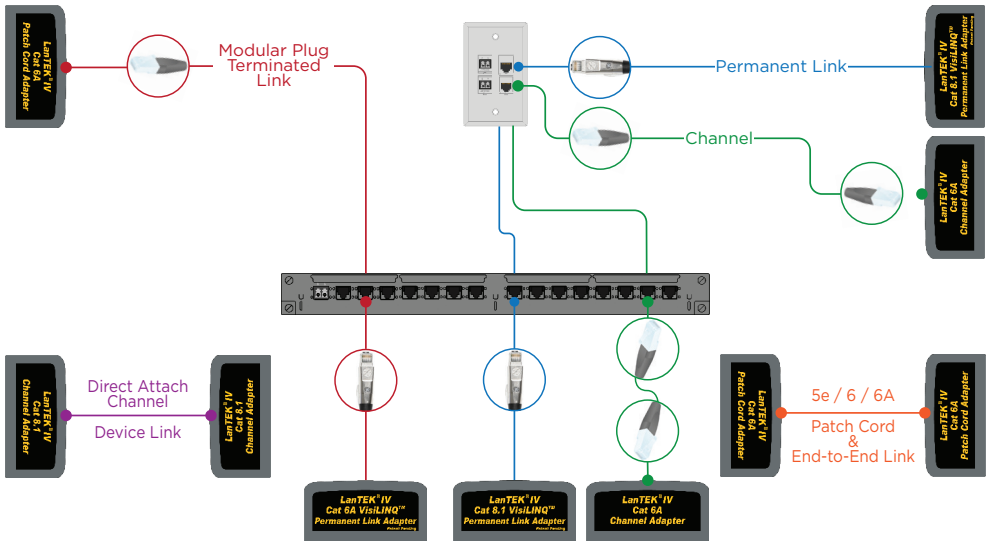

TREND AnyWARE Cloud

With TREND AnyWARE Cloud, you no longer have to download and install test management software to a PC.

Create an account at <https://anyware.trend-networks.com>

Please use: Google Chrome, Microsoft Edge, or Mozilla Firefox.

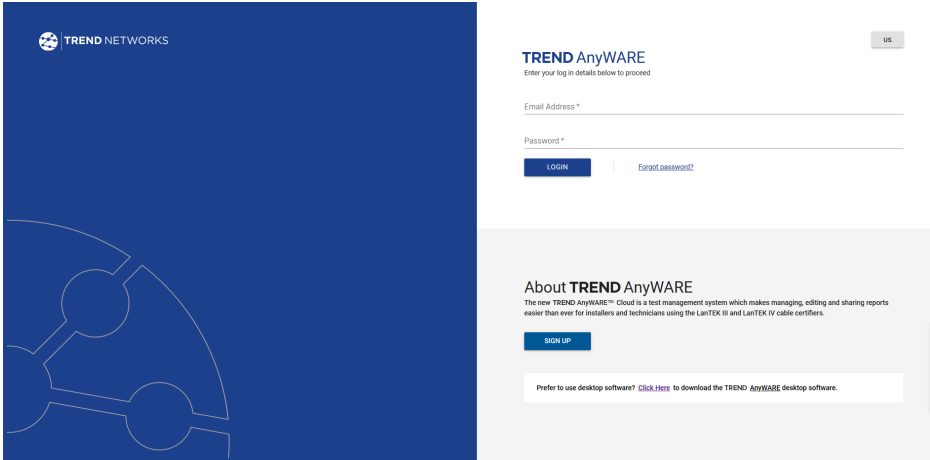

TREND AnyWARE CLOUD allows management of projects using LanTEK IV certifiers.

1. Who has the certifier
2. Date of last software update
3. Calibration date
4. When the results were last synchronized

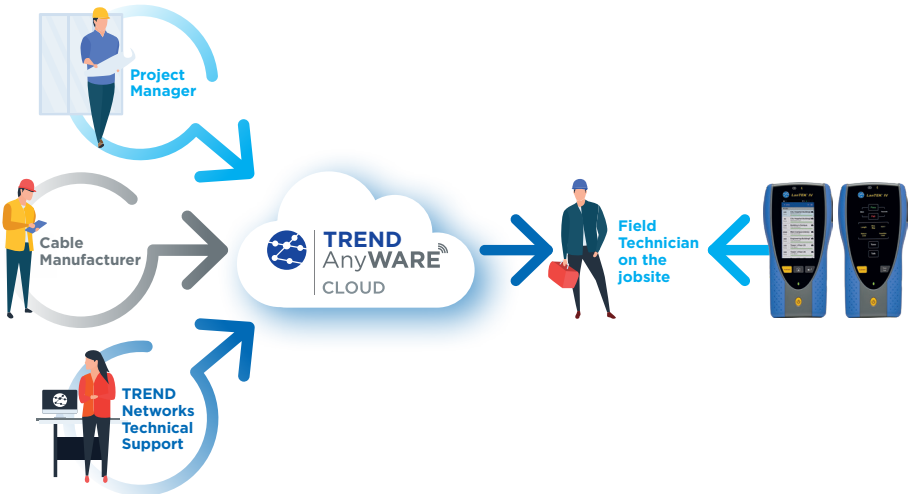

TREND AnyWARE Cloud

Please register your LanTEK IV to receive updated information at: <https://www.trend-networks.com>

An account is required to download software and documentation.

TREND NETWORKS

TREND ANYWARE CLOUD SUPPORT WEBINARS CONTACT

COPPER DATA CABLE METER FIBER DATA CABLE METER CCTV, NETWORK INDUSTRIAL DATACOM TOOLS

SUPPORT
Welcome to our support centre. Please click on the support centre icon to access our support centre.

Product Registration
Register your LanTEK IV and you'll receive service information. Registration requires a valid email address.

Service & Warranty
Click here for information on product and service centres.

Your details

★ **FIRST NAME**
First name *

★ **YOUR COMPANY**
Your company *

★ **ADDRESS 1**
Address 1 *

★ **TOWN/CITY**
Town/City *

★ **ZIP CODE**
Zip code *

★ **TELEPHONE**
Telephone *

Login **Sign up**

Email

First Name Last Name

Password

Confirm Password

I accept the Terms of Service and Privacy Policy
Please keep me up to date with the latest product news

SIGN UP

Software & Brochures
and view the latest manuals, quick reference guides, and software updates. Registration is required.

To get in touch with your local TREND NETWORKS office.

NAVIGATION ✕

👤 Jobs

ADMINISTRATION

👤 User Accounts

👤 Customers

📱 Devices

📄 Reports

🔍 Help

Link LanTEK IV to your AnyWARE account. Select the Navigation menu:



Select "Device", add your LanTEK IV with  on the menu at the top right.

Enter the identifier of your LanTEK IV via the entry screen.

TREND AnyWARE Cloud

Serial No	Last Online	Engineer	Calibration Due	Total Tests	Status
To create a device, press the plus button above					

PREVIOUS Page 1 of 1 10 Rows NEXT

ADD DEVICE

Serial Number *

Device ID should be of format xxxxxxxx/xxxxxxxx

SUBMIT

Settings	
Device ID	1631210G/19310009
Operation Mode	Standard
Set Language	US English
Wi-Fi	>
Set Reference	>
Calibration	>
Tone Test	>
Device Settings	>
System Settings	>

You will find the Device ID in "Settings"  on the LanTEK IV.

LanTEK IV configuration: Settings menu

Press on the gear icon at the top right of the screen to open the Settings menu



Choose user interface mode

Choose language

Connect to Wi-Fi hotspot

Set Reference: calibrate system for Cat 8.2, RJ45 patch cord adapters and fibre optic test cords

View calibration information / Copy the calibration certificate to a USB key in PDF format

Start the tone generator

Device model, software versions, serial number, MAC address

Update device software

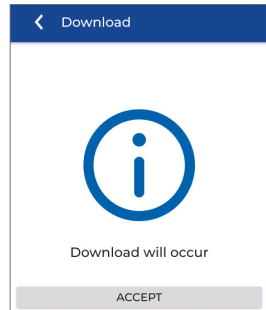
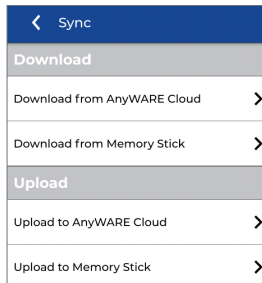
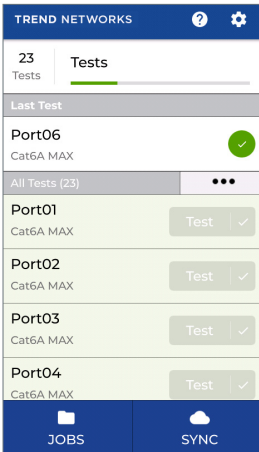
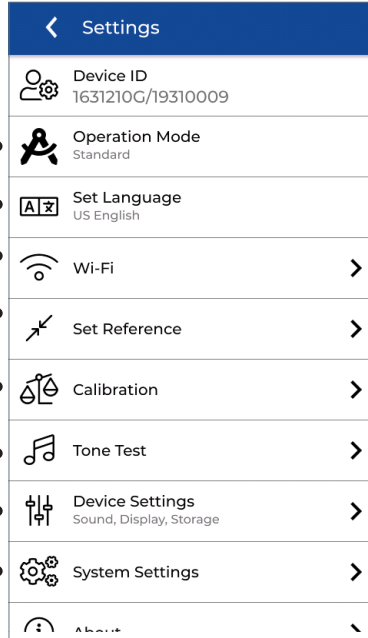

Press “SYNC” to import or export test files. Import transfers blank test files from a USB key or AnyWARE Cloud to the LanTEK. Export transfers completed test results to a USB key or AnyWARE Cloud.

Press Accept after choosing an option.

Default Autotest Settings

This will save a standard configuration in the tester that will be the default setting each time new tests are created, reducing setup time. The standard can be changed when creating new tests as needed.

The image shows two screenshots from a mobile application. The left screenshot is titled 'Device Settings' and lists several categories: Regional Settings, Operator Details, Autotest Default Settings, Sound / Volume, Display Brightness, Remote Control Settings, and UI Settings. Arrows point from text labels to the 'Autotest Default Settings' item and from other labels to the right-hand screenshot. The right-hand screenshot is titled 'Autotest settings' and shows a configuration form for 'Test Range: Port-01'. The form includes fields for 'Default job identifier type' (set to 'Not Required'), 'Test prefix', 'Port', 'Starting range' (set to '01'), 'End range' (set to '24'), and 'Copper test standard'.

Default Autotest parameters: define the configuration for future tests

- Set date, time and units of measure
- Enter operator name
- Volume settings
- Screen brightness
- Activate remote control (Team Viewer)
- Show cursor when using USB mouse

Autotest settings

Test Range: Port-01

Default job identifier type

Not Required

Test prefix

Port

Starting range

01

End range

24

Copper test standard

Wi-Fi Settings

To connect LanTEK IV over Wi-Fi, tap Settings 



Select “Wi-Fi” - then activate it using the switch at the top right (green when active)

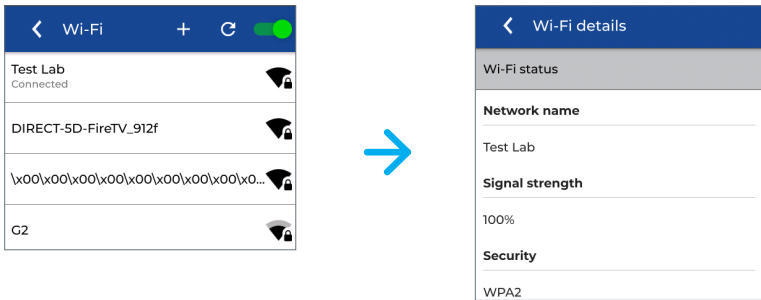

Select a network and enter the password if required

Wi-Fi is then connected if the wave logo at the top right is not crossed out

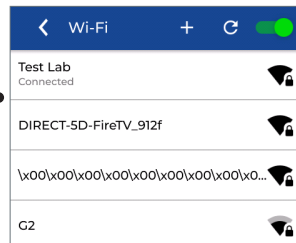

Make sure that the signal strength is greater than 50%.

Once connected, tap on the network name to view Wi-Fi details including the security settings, IP address and MAC address.

On a site without a Wi-Fi network, use internet sharing with a mobile phone that will be on a conventional mobile network.

Once connected, tests can be uploaded/download to AnyWARE Cloud using “SYNC” from the home screen.

Importing/Exporting jobs

The SYNC menu allows importing pre-configured jobs from AnyWARE Cloud or Desktop software to the LanTEK IV.

Completed tests can be uploaded to AnyWARE Cloud when connected to Wi-Fi. Jobs are synchronized between AnyWARE Cloud and the LanTEK IV. Tests added to a job on AnyWARE Cloud will be downloaded to LanTEK and tests created on LanTEK will be added to the corresponding job on AnyWARE Cloud.

Alternatively, AnyWARE Desktop provides test management and reporting from a PC without using cloud services. Jobs created on AnyWARE Desktop can be exported to a USB key and downloaded to LanTEK.

Completed tests can be exported from LanTEK to a USB key then uploaded to AnyWARE Desktop and added to the corresponding job. Each test result is saved with a file whose extension is .res (result).

USB keys up to 512GB are supported and must be formatted as FAT32.



Select
SYNC

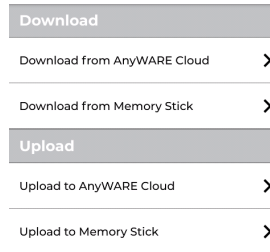

Download imports jobs into the LanTEK for testing. Upload sends completed tests for viewing/reporting with TREND AnyWARE.

Note: the Memory Stick option is visible only when a USB key is connected to the LanTEK.

User Interface Operating Modes

LanTEK IV version 1.50 software adds a new user interface mode that allows testing without the need to create a job with pre-configured tests. The new mode is called “Standard” and the existing mode is called “Advanced”.

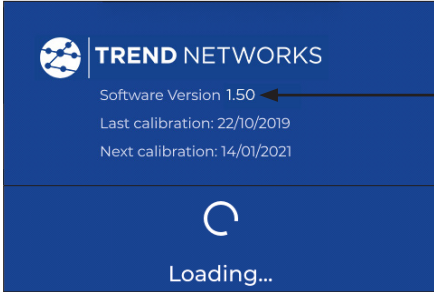

Ensure the installed software is version 1.50 or higher

The installed software version is displayed on the information screen while booting.

Select the desired operation mode in the Preferences menu.

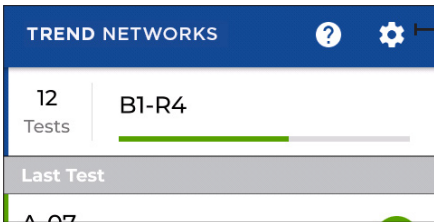

Open the Preferences menu

Press the gear icon to open the Preferences menu.

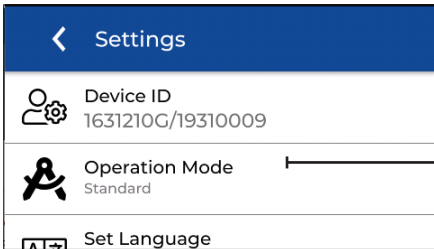

Open Operation Mode selection

Press Operation Mode to reveal the mode selection screen.

The currently selected Operation Mode is shown in small font.

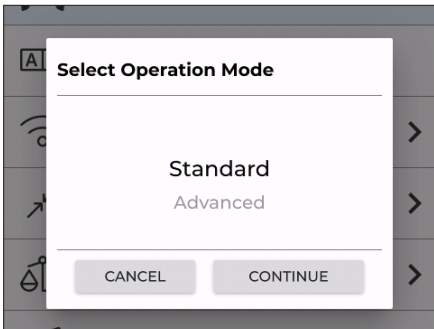

Choose desired mode

Standard = simplified mode that allows setting name and specifications for each individual test.

Advanced = mode that allows pre-configuration of jobs with names and specifications prior to testing.

Standard User Interface Operation

Testing with Standard mode requires setting four parameters before a test can be started.

All parameters can be set from the Home screen and each Autotest will be run with the same parameters as the previous test. The last character of the test name is incremented by one digit (either letter or number).

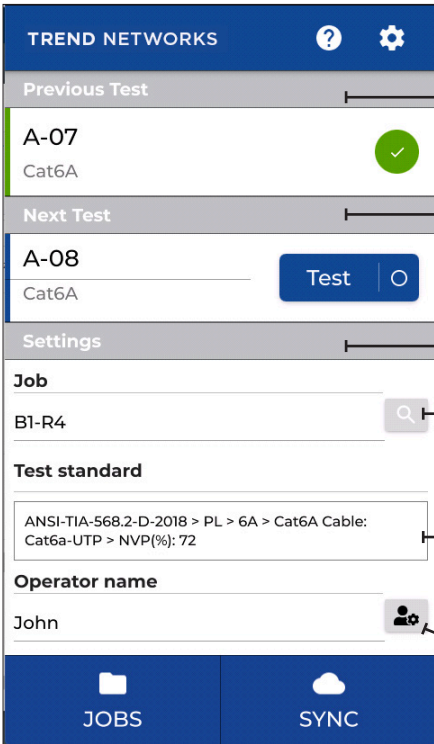

Previous Test - Name, type and result of the test that was previously performed. Touch the test name to open the results page.

Next Test - Name of the next test to be run. The last character increments with each test. The test name can be changed by touching the name. Touch Test or press the Autotest key to perform a test.

Settings

Job - Name of the folder where the next test will be stored. Touch the “search” icon to create or select a different job.

Test standard - Summary of the test limit and cable type that will be used for the next test. Touch the box to change the test standard settings.

Operator name - Name of user that is stored with each test. Touch the user icon to change the operator name or add a new one.

Next Test

The name of the next test to run is entered into the Next Test field. The name will automatically increment the last character following each test.

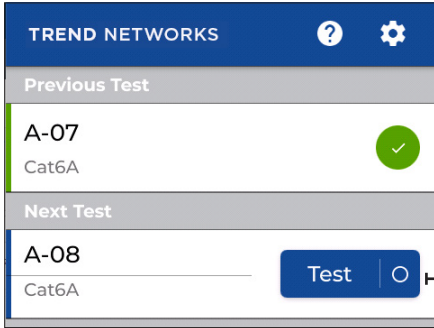

Press Test to perform a test and save it as ID "A-08".

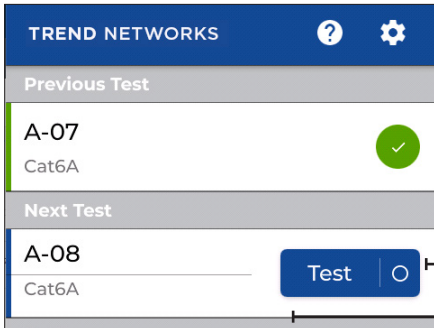

The Test icon turns grey when a test is running.

The status bar increases to show the test progress.

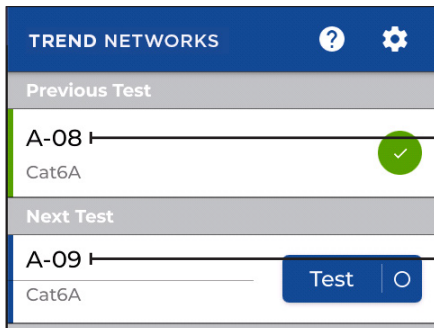

Test A-08 is saved and is now in the Previous Test section.

Next Test is incremented to A-09 and is ready for testing as indicated by the blue Test icon.

Edit Next Test

Change the Next Test name by touching the name and use the keyboard to enter the desired name.

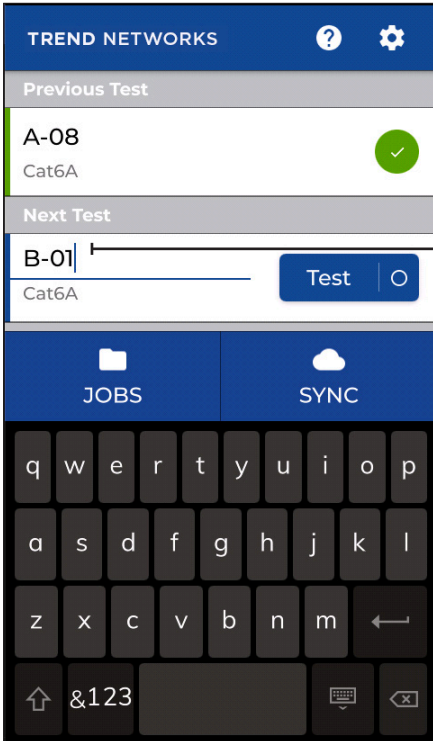

Type the desired name for the next test to perform and press the Enter key to accept.

Press Enter when finished editing the test name.

Job Selection

A new or existing Job can be selected for test storage.

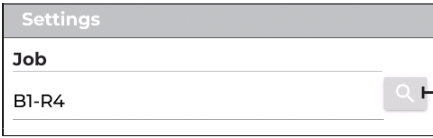

Press the search icon to open the Jobs screen. to perform a test and save it as ID "A-08".

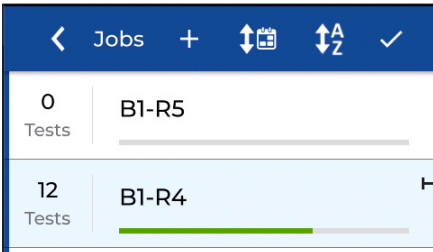

The currently selected Job is highlighted in blue.

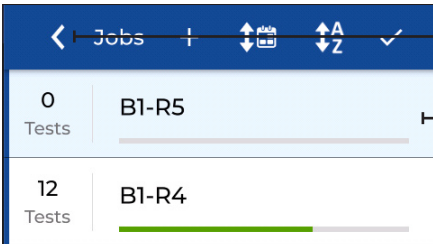

Touch the back arrow when the desired job is selected.

Touch the name of an existing Job to make it active. The line will turn blue to indicate the selection

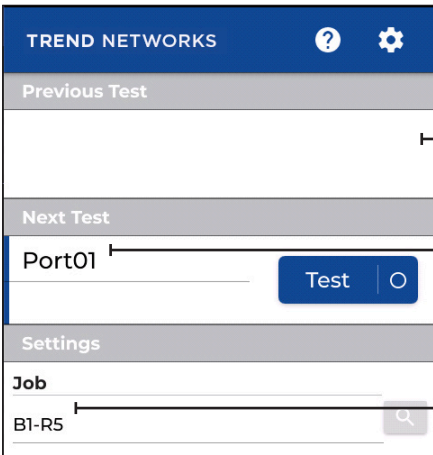

Previous Test is blank because there are no tests in the active Job.

The default test name is Port01, touch the name to edit.

Job B1-R5 is now active.

Creating a new job

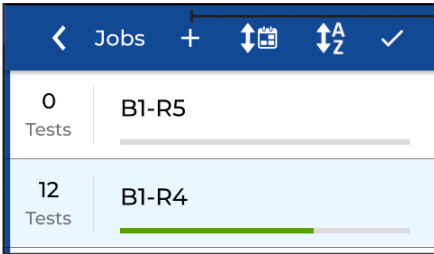

Press + to create a new job.

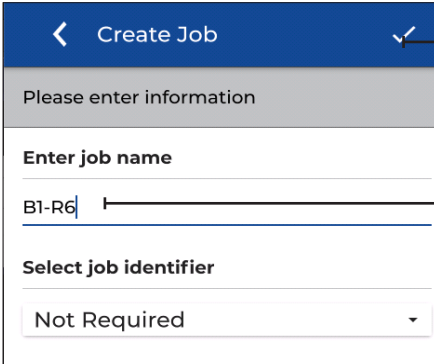

Press the tick when finished entering the new name.

Enter the name of the new job.

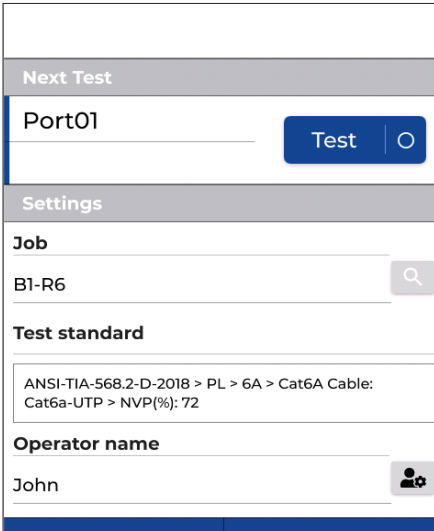

Selecting test standards

Test limits and cable type are changed by touching the Test Standards box.

The screenshot shows a 'Settings' screen with the following fields:

- Job:** B1-R4
- Test standard:** A box containing the text 'ANSI-TIA-568.2-D-2018 > PL > 6A > Cat6A Cable: Cat6a-UTP > NVP(%): 72'. An arrow points to this box from the text 'Touch the Test Standard box to open the settings.'
- Operator name:** John

Touch the Test Standard box to open the settings.

The screenshot shows a 'select standards' screen with the following sections:

- ANSI-TIA-568.2-D-2018** (Standard)
- PL** (Link model)
- 6A** (Grade)
- Cat6A** (Cable type)
- Cable details** (Section header)
- Cable:** Cat6a-UTP
- Connector brand (Near):** Generic
- Connector brand (Far):** Generic
- NVP:** Cable shielded

Select the required settings and press the tick when finished.

Selecting the Operator name

The operator name can be selected from a list of previously entered names or a new name can be added to the list. The operator name is included with the test result and appears on printed certification reports.

The screenshot shows the TREND NETWORKS mobile application interface. At the top, there is a blue header with the text "TREND NETWORKS", a question mark icon, and a gear icon. Below the header, there are three main sections: "Previous Test", "Next Test", and "Settings".

- Previous Test:** Shows a test labeled "A-07" with the category "Cat6A" and a green checkmark icon.
- Next Test:** Shows a test labeled "A-08" with the category "Cat6A" and a blue "Test" button with a circular icon.
- Settings:** Contains several fields:
 - Job:** A text input field containing "B1-R4" with a search icon on the right.
 - Test standard:** A text area containing "ANSI-TIA-568.2-D-2018 > PL > 6A > Cat6A Cable: Cat6a-UTP > NVP(%): 72".
 - Operator name:** A text input field containing "John" with a small icon of two people and a gear, which is highlighted by a black dot and a line pointing to the explanatory text on the right.

At the bottom of the app, there are two blue buttons: "JOBS" with a folder icon and "SYNC" with a cloud icon.

Touch the operator icon to change the name of the current operator.

The screenshot shows the "Operator details" screen in the mobile application. The title bar is blue with a back arrow, the text "Operator details", and a plus sign. Below the title bar, there is a list of operator names:

- "John" is selected, indicated by a light blue background and a black checkmark on the right.
- "Daniel" is listed below "John".
- There is an empty space below "Daniel", suggesting a scrollable list.

Choose a different operator name or press + to enter the name of a new operator.

Live wiremap

Live wiremap displays a real-time wiremap diagram without the need to run a full Autotest. This can be launched in two ways: as an optional display in the home screen test list, or directly from the pull-down menu from any screen.

To activate Live wiremap directly: slide your finger down from the top edge of the screen to reveal the shortcut menu. Live wiremap is shown at the bottom half of the display.



To activate Live wiremap from the home screen tap options to open the selection menu.

Choose Live wiremap to enable the function.

Use the home screen options menu to deselect Live wiremap when desired.

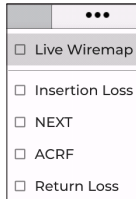
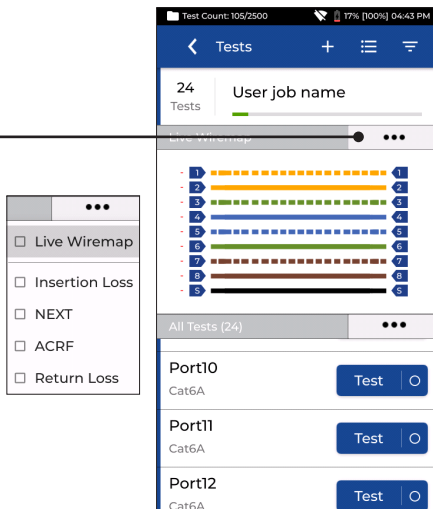

Creating test files

Note: most items in a list have secondary options that can be viewed by long-pressing the item, similar to the right-click function of a mouse.

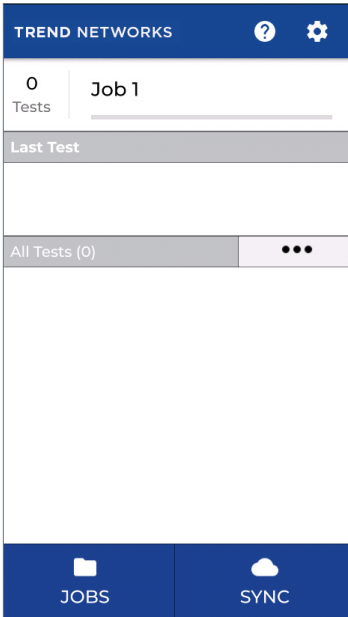

The home screen shows the active job, the test that was previously run, and a list of remaining scheduled tests in the job.

A job named “Job 1” is the default job in a new LanTEK IV.

The operating workflow consists of creating a job for a customer, project, building, etc...

Then test files with unique ID’s are added to jobs with the performance standard to be tested.

This system allows quick testing of numerous tests with minimal configuration.

Press JOBS to open the list of available job folders.

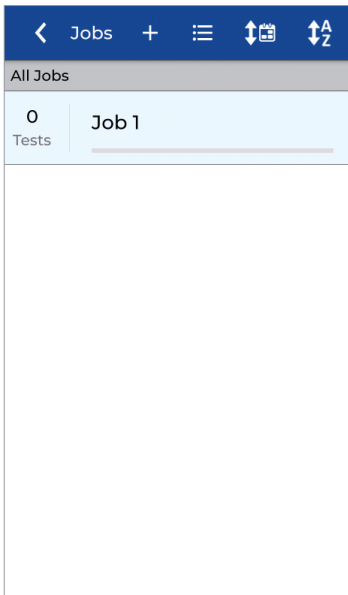

Press the + button to create a new job.

Creating test files

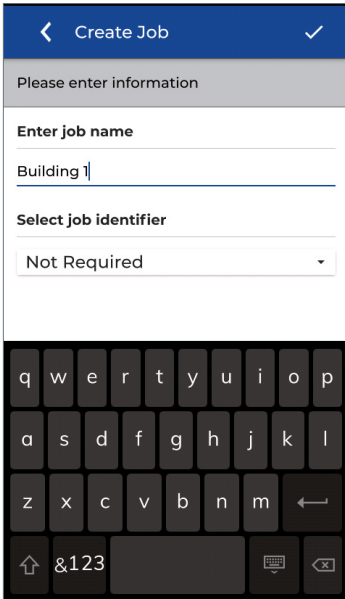

The screenshot shows a mobile application interface for creating a job. At the top, there is a blue header with a back arrow, the text "Create Job", and a checkmark. Below the header is a grey bar with the text "Please enter information". The main form area has two sections: "Enter job name" with a text input field containing "Building 1", and "Select job identifier" with a dropdown menu currently set to "Not Required". A virtual keyboard is visible at the bottom of the screen.

Enter the name of the new job using the touch keyboard; In this example, the name is "Building 1". Confirm with the check mark at the top-right of the screen.

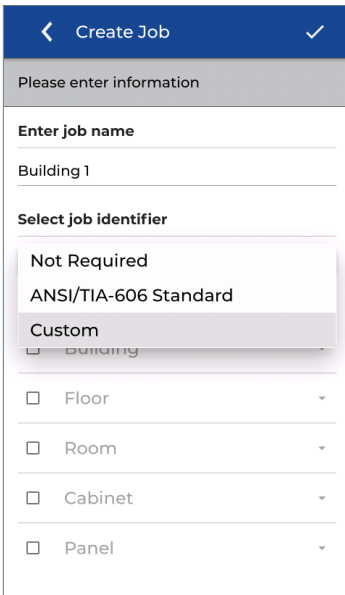

This screenshot shows the same "Create Job" form, but with the "Select job identifier" dropdown menu expanded. The menu lists several options: "Not Required", "ANSI/TIA-606 Standard", "Custom", "Building", "Floor", "Room", "Cabinet", and "Panel". Each option is preceded by a small square icon. The "ANSI/TIA-606 Standard" option is currently selected and highlighted.

Optional test identifiers (building, floor, room, rack, panel, etc.) can be added to each test ID to provide more details.

ANSI/TIA-606 mode follows the naming convention defined by the TIA-606 standard.

The Custom mode allows identifiers that describe the location of the cable under test.

Creating test files

The screenshot shows a mobile application interface for creating a job. At the top, there is a blue header with a back arrow, the text 'Create Job', and a checkmark. Below the header is a grey bar with the text 'Please enter information'. The main form area has a white background. It starts with the label 'Enter job name' followed by a text input field containing 'Building 1'. Below that is the label 'Select job identifier' followed by a dropdown menu showing 'Custom'. The next section is 'Custom identifier setup', which contains four rows. Each row has a checkbox on the left and a dropdown menu on the right. The first row has a checked checkbox and a dropdown showing 'Building'. The second row has an unchecked checkbox and a dropdown showing 'Floor'. The third row has an unchecked checkbox and a dropdown showing 'Room'. The fourth row has a checked checkbox and a dropdown showing 'Rack'. The fifth row has a checked checkbox and a dropdown showing 'Panel'.

Add a tick mark next to the desired identifier categories.

This screenshot is similar to the one above, but the 'Custom identifier setup' section is expanded. The dropdown menu for the 'Rack' row is open, showing a list of options: 'Cabinet', 'Rack', 'Enclosure', 'MDF', 'Frame', 'Wall Space', and 'Panel'. The 'Rack' option is highlighted. The checkboxes for 'Rack', 'Wall Space', and 'Panel' are checked, while 'Cabinet', 'Enclosure', and 'MDF' are unchecked. The 'Rack' dropdown menu is currently showing 'Rack'.

Several predefined options exist for each element of the identifiers

Tap the drop-down menu next to each ID to choose an identifier.

Creating test files

← Create Job ✓

Please enter information

Enter job name

Building 1

Select job identifier

Custom

Custom identifier setup

Building

Floor

Room

Rack

Panel

Press the check mark to save the configuration.

← Jobs + ☰ ⬆️ ⬆️ ⬆️ ⬆️ ⬆️ ⬆️

All Jobs

0 Tests Job 1

0 Tests Building 1

The list is updated with the new job called “Building 1”.

The next step is to open the job folder and prepare it by adding tests.

Press the name of the desired folder to open it.

Creating test files



The Building 1 folder is open - tests can now be added, deleted, or edited.

Press + to add new test files.

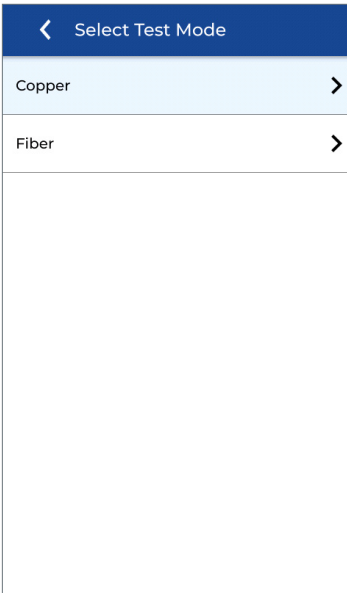

The first step is to select a type of measurement: Copper or Fiber optic.

Press Copper to continue.

Creating test files

The screenshot shows a mobile application interface for creating tests. At the top is a blue header with a back arrow, the text 'Create Tests', and a checkmark. Below the header is a grey bar displaying 'Test Range: Cable-01:24'. The main form area contains several sections: 'Test prefix' with the value 'Cable-'; 'Test range from:' with the value '01'; 'Test range to:' with the value '24'; 'Copper test standard' with a dropdown menu showing 'Selected standard' and 'ANSI/TIA-568.2-D-2018 > PL > 6A > Cat6A'; 'Test identifier' which is empty; and 'Building' with a text input field containing 'Enter building ...'.

This screenshot is similar to the one above but for a different test range. The grey bar at the top shows 'Test Range: Cable-01A:12D'. The 'Test prefix' is 'Cable-'. The 'Test range from:' is '01A' and the 'Test range to:' is '12D'. The 'Copper test standard' dropdown is highlighted with an orange border and shows the same selected standard: 'Selected standard' and 'ANSI/TIA-568.2-D-2018 > PL > 6A > Cat6A'. The 'Test identifier' and 'Building' fields are identical to the previous form.

Test IDs consist of a prefix (fixed name - for example “Cable”) and a range of numbers (example “1 to 48”)

The prefix is the same for all future names created. Alphanumeric and special characters are allowed; while the “/” and “\” characters are not allowed. A space or dash after the name can be added as a separator, example “Cable-01”

The start and end range define the start and end limits of the counter. The numbers will be automatically incremented; in the previous example this will create Cable-01 to Cable-24.

This range is alphanumeric and no special characters are allowed. The number of characters in the start and end fields must be the same.

In another example, the range is from 01A to 12D. Test names will be created as follows:

- Cable-01A
- Cable-01B
- Cable-01C
- Cable-01D
- Cable-02A
- Cable-02B
- ...
- Cable-12D

Automatic incrementing supports almost all combinations of numbers and letters.

Press the “Test standard” box to continue the configuration.

Creating test files

Cable Standard	
Select a group	
ANSI/TIA-568.2-D-2018	
ISO/IEC 11801-1:2017 A1/2	✓
ISO/IEC 11801-9909:2019 25Gb/s	
CENELEC EN50173-1	
Custom	
AS NZ 3080:2013	
Belden4K	
Component	
EL-3600-6	
Ethernet	

Cable Standard	
ISO/IEC 11801-1:2017 A1/2	
Standard	
Select link model	
Channel	
Patch Cord	
Permanent Link	✓

Choose the desired test standard family.

In this example select:
ISO/IEC 11801-1: 2017 A1/2

Select the certification method.

Permanent link is the most common and certifies from patch panel to work area outlet. Cable terminated with female connectors at both ends.

In Channel certification, two patch cords (equipment room and work area) are added. This is more complete since it also takes into account the quality of the cords in addition to the horizontal link.

Channel adapters are required and the patch cords used for certification must remain in place after each test.

Creating test files

← Cable Standard

← ISO/IEC 11801-1:2017 A1/2
Standard

← Permanent Link
Link model

Select grade

BCT-B-L

BCT-B-M

C

CLASS_I

CLASS_II

D

E

EA

Choose the performance class for certification.

In this ISO example, Class EA certifies cabling up to 500 MHz for Ethernet applications up to 10 Gigabit.

← Cable Standard ✓

← ISO/IEC 11801-1:2017 A1/2
Standard

← Permanent Link
Link model

← EA
Grade

← Class EA PL1 PL2 CP1
Cable type

Cable details

Cable
Cat6a-STP

Connector brand (Near)
Generic

Connector brand (Far)
Generic

NVP (%) Cable shielded
75 **MEASURE NVP**

In ISO / IEC there are different sub-families of link models within the EA Class.

- PL1 PL2 CP1 is a typical Permanent female / female link
- PL3 is a Permanent link with the addition consolidation point connection.

Creating test files

< Cable Standard

- < ISO/IEC 11801-1:2017 A1/2**
Standard
- < Permanent Link**
Link model
- < EA**
Grade

Select cable

- Class EA MAX PL1 PL2 CP1
- Class EA MAX PL3
- Class EA PL1 PL2 CP1**
- Class EA PL3

The MAX limit options test the same links with additional optional measurements carried out: TCL, ELTCTL, and DC resistance unbalance (DCRU).

LanTEK IVs always measure these parameters up to 500MHz and the results are displayed as informative with an “i” indicator instead of PASS/FAIL.

If the MAX test is selected then these measurements are marked PASS/FAIL according to the limits defined by the selected test standard.

Select Class EA PL1 PL2 CP1.

< Cable Standard ✓

- < ISO/IEC 11801-1:2017 A1/2**
Standard
- < Permanent Link**
Link model
- < EA**
Grade
- < Class EA PL1 PL2 CP1**
Cable type

Cable details

Cable
Cat6a-STP 

Connector brand (Near)
Generic 

Connector brand (Far)
Generic 

NVP (%) Cable shielded
75 **MEASURE NVP**

The Cable Type selection is intended to provide more detail on the nature of the components installed: the cable category, shield type, NVP and optionally the brand and model. The brand of the connectors may be defined if desired.

The options chosen here do not affect the test limits or performance measurements, the only exception being the length measurement.

Press the cable search icon to choose from the list of manufacturers of on-board cabling systems.

Creating test files

< Pick a brand

Select Manufacturer

- Datwyler >
- Draka >
- EasyLan >
- Excel >
- Furukawa >
- Generic >**
- Genesis >
- Gigamedia >
- Hellermannntyton >
- Hubbell >

A specific brand and model can then be selected - or choose “Generic” if a specific brand is not desired.

The name of the selected cable will appear on the certification report.

Choosing a brand and model automatically sets the NVP (nominal velocity of propagation) as defined by the manufacturer.

NVP is important for correctly measuring the length of a link; it only affects this measurement and no others.

When the “Generic” is selected, the NVP can be manually entered or calculated using a cable link of known length.

< Cable Standard ✓

< ISO/IEC 11801-1:2017 A1/2
Standard

< Permanent Link
Link model

< EA
Grade

< Class EA PL1 PL2 CP1
Cable type

Cable details

Cable
Cat6a-UTP

Connector brand (Near)
Generic

Connector brand (Far)
Generic

NVP (%) Cable shielded
72

MEASURE NVP

The connector brand is optional and will appear on the report. A list of brands is available by pressing the search icon.

In this example, a “Generic” cable is selected and the NVP will be determined by measuring a known length of cable.

Press “Measure NVP” to begin the measurement process.

Creating test files

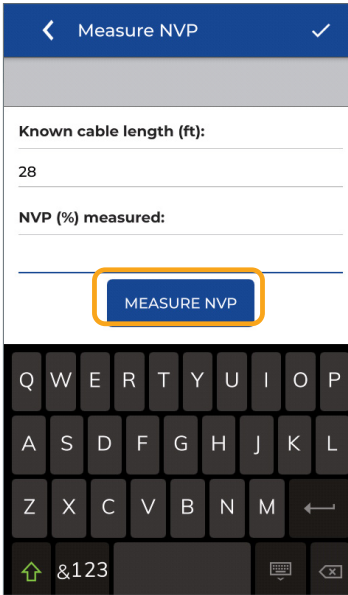

Connect a link of 20 meters / 65 feet minimum between the two LanTEK IV handsets.

Enter the length of the link including any test cords.

In this test, the link is 24 meters plus the 2 permanent link adapters of 2 meters each, for a total of 28 meters.

Enter 28 into the length field. Note, the units are set to meters or feet depending on the units set in the tester preferences.

Press the blue “Measure NVP” button to continue.

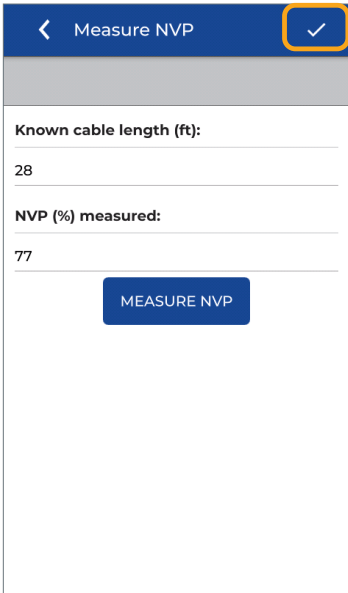

The calculated NVP will be displayed, here it is 77%.

Press the check mark to confirm and continue.

Creating test files

← Cable Standard ✓

← ISO/IEC 11801-1:2017 A1/2
Standard

← PL
Link model

← EA
Grade

← Class EA PL1 PL2 CP1
Cable type

Cable details

Cable
Cat6a-UTP

Connector brand (Near)
Generic

Connector brand (Far)
Generic

NVP (%) Cable shielded
77 **MEASURE NVP**

Review the configuration parameters and press the check mark to continue.

← Create Tests ✓

Test Range: Cable-01:24

Test range from:
01

Test range to:
24

Copper test standard
Selected standard
ANSI/TIA-568.2-D-2018 > PL > 6A > Cat6A

Test identifier

Building 1

Rack A

Panel 01

If all parameters are correct, press the check mark to confirm and create the list of tests.

Press the home button  to return to the home screen.

Creating test files

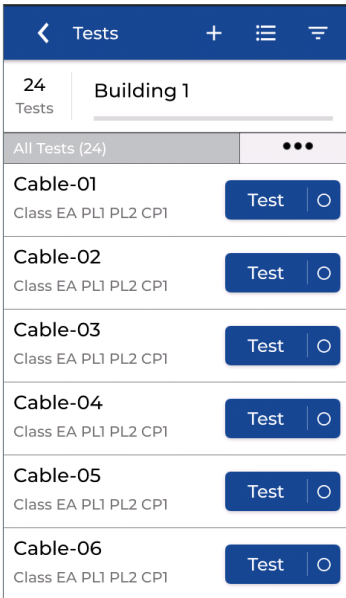

Here, the home screen with the new job and test ID's is shown.

The “Test” icon will turn blue when the main and remote handsets are connected to a link. If the icon remains gray it means that there is a problem: remote off, testers not connected to the same link or the link is broken.

The LanTEK IV handsets are able to communicate if at least two (2) wires in the cable have continuity. Even when the two wires are not of the same pair within the cable.

Presentation of tests

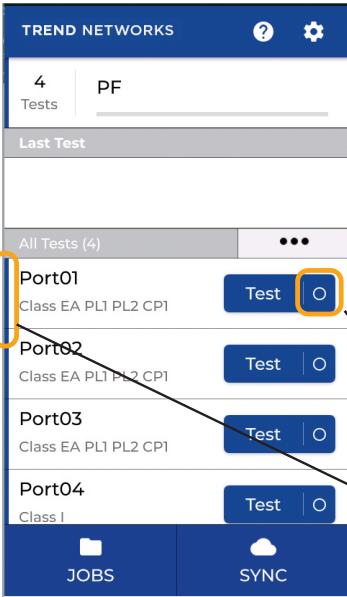

The colors of the test icon and the vertical bar to the left of the name indicate the status of each test in the folder.

In addition, the blue color of the Test icon and the circle symbol indicate that the two handsets are correctly connected and ready to test.

Circle: not tested

Blue bar = not tested

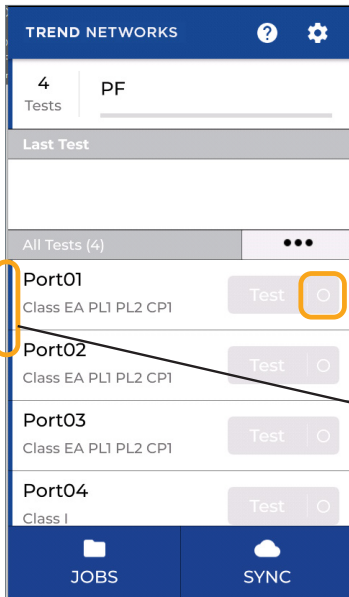

If the buttons are gray it means that the two handsets are not connected correctly and an Autotest cannot be started.

Gray button: handsets not connected

Circle: not tested

Blue bar = not tested

Presentation of tests

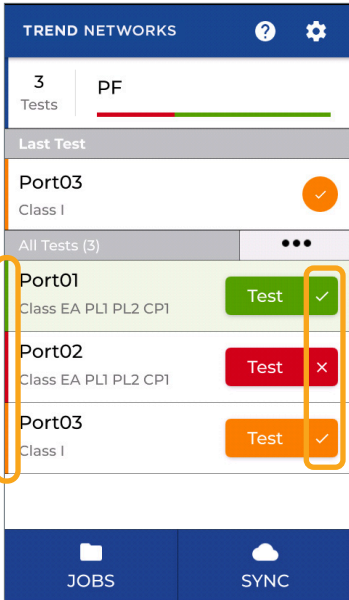

Colored test buttons:

Main and remote handsets are connected and ready to test

Green bar / green box = Pass

Red bar / red box = Fail

Orange bar / orange box: marginal Pass/Fail

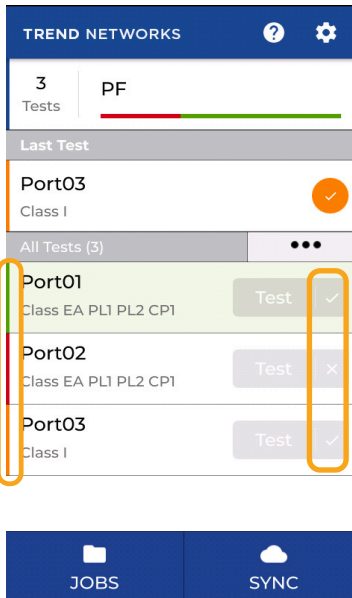

Grey test buttons:

Main and remote handsets are not connected and an Autotest cannot be started

Green bar / green box = pass

Red bar / red box = failure

Orange bar / orange box: marginal Pass/Fail

Performing tests

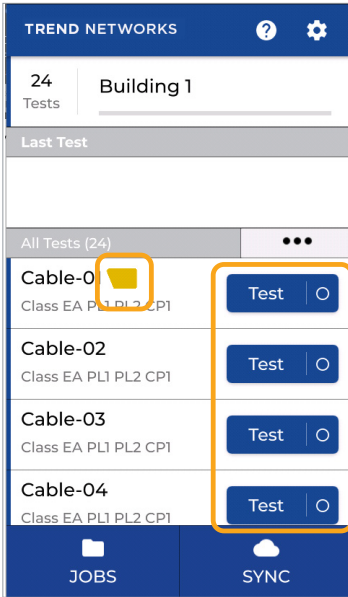

An Autotest can start only if the two handsets are correctly connected to the same link to be tested.

Ready to test indicators:

1. On-screen test buttons are blue
2. The Autotest icon is displayed



3. A musical melody is heard
4. The link symbol at the top of the handset lights up blue
5. VisiLINQ Permanent Link adapters light up blue

Performing tests

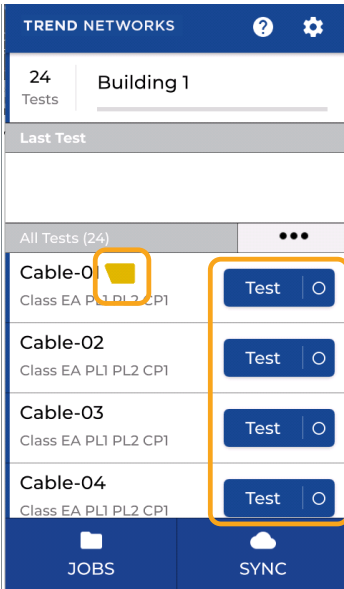

Options to perform an Autotest:

1. Press the Autotest key on each handset
2. Press the blue Test button on the screen
3. Press the black circular button on the end of the VisiLINQ adapter

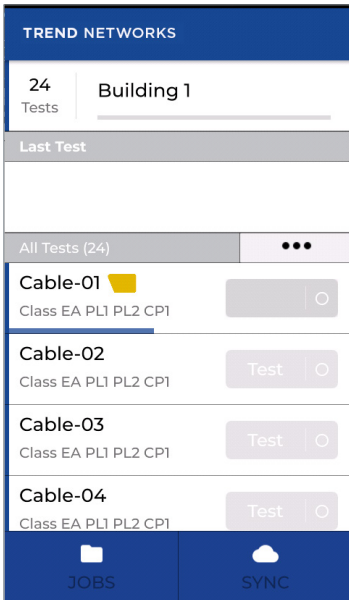

A blue progress bar is displayed while the test is running.

Display of test results

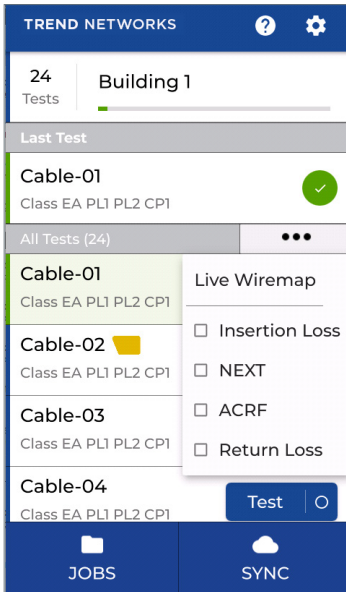

Information on the details and margins of the test measurements is available on the list of tests for completed Autotests.

Press the **•••** button to open the options on the Home screen. Select an option to display the desired measurement related to the test number.

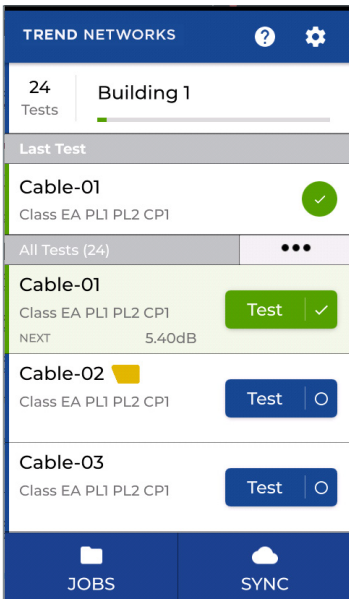

When activated, the margin of the selected measurement will be displayed for each completed Autotest.

Press the name of the test to open the measurement results screen.

Display of test results

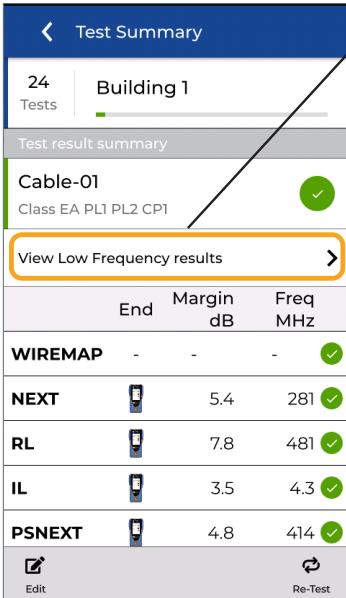

Press “View Low Frequency results” to display the measurements not present on the first page.

The measurements appear with the representation of the main or remote handset to indicate which side the link has the worst value or fault.

Scroll down to see the full list on the first page.

The wiremap is always at the top of the list because it is a common failure mode, unless there is a failed measurement.

You can re-run the test or edit it (to rename it for example) with the buttons at the bottom of the screen.

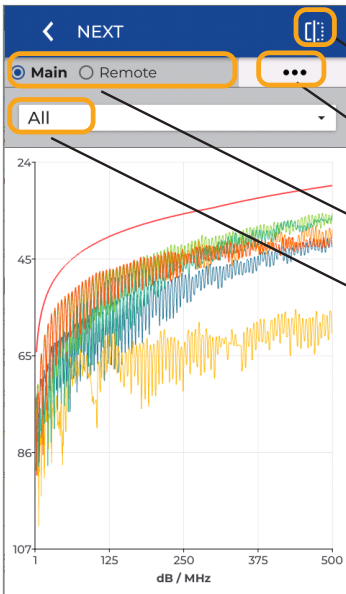

Tap a measurement from the summary screen to open the detailed view of the results.

Switch between graphical or tabular view.

Graphic display options.

Switch between main and receiver handset view

Select the pairs to display on the plot.

Display of test results

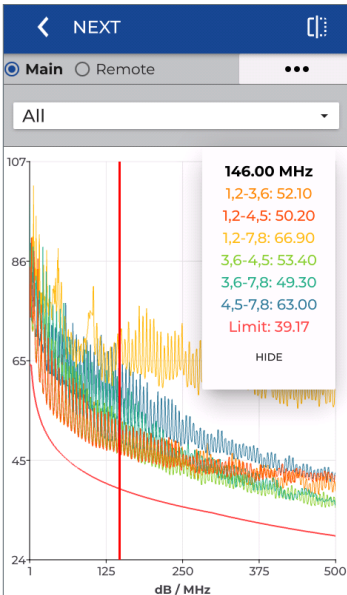

Tap any point on the plot to display the frequency, the measured value and the associated limit.

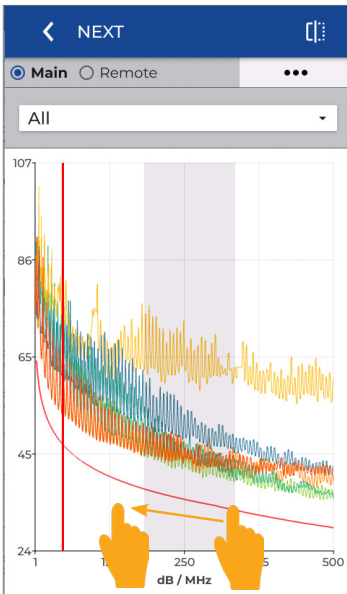

Slide your finger across a range to enlarge the view.

Display of test results

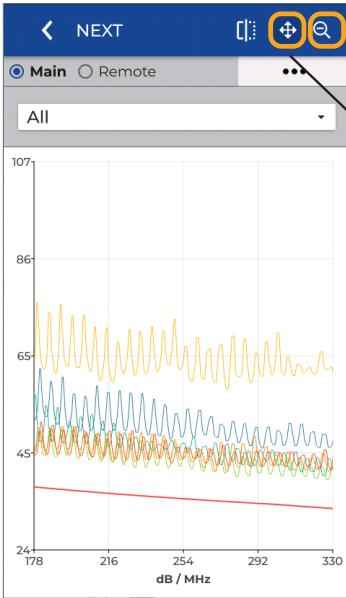

An enlarged view of the plot allows a detailed analysis.

Zoom out for normal view.

Switch between scroll and zoom functions. In scroll mode swiping the screen will slide the view of the graph while maintaining the current zoom level.

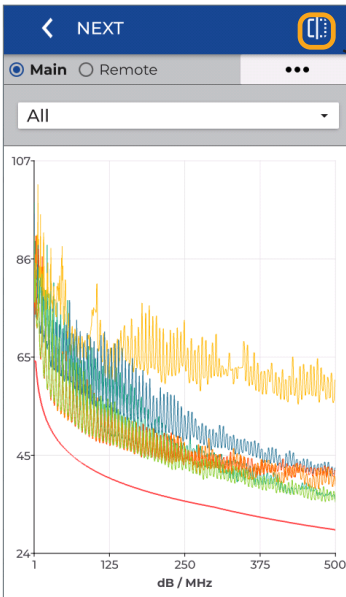

Switch to the tabular view of the data.

Display of test results

Pair	Side	Margin dB	Limit dB	Freq MHz
1,2-3,6		6.6	34.8	270
1,2-4,5		6.9	37.7	178.5
1,2-7,8		23.9	36.3	218.0
3,6-4,5		5.4	34.5	281
3,6-7,8		6.0	30.9	419
4,5-7,8		11.4	30.2	450

The tabular view of the measurements displays the lowest margin, and the frequency point where the measured value is closest to the test limit.

Press return to return to the test summary screen.

24 Tests Building 1

Test result summary

Cable-01

Class EA PL1 PL2 CP1

View Low Frequency results

	End	Margin dB	Freq MHz
WIREMAP	-	-	-
NEXT		5.4	281
RL		7.8	481
IL		3.5	4.3
PSNEXT		4.8	414

Edit Re-Test

Press View Low Frequency results results to display the second page with low frequency/DC measurements.

Display of test results

Summary: Low Freq	
24 Tests	Building 1
Cable-01	✓
Class EA PL1 PL2 CP1	
Test Details	
SKEW	✓
WIREMAP	✓
DELAY	✓
DCLR	✓
DCRU PAIR-PAIR	i

Presentation of the measurements on the second page.

The "i" symbol indicates that this measurement is either optional or meets certain criteria where a pass / fail result is not required.

Test list options

The list of tests can be customized to display the margin values for several key metrics, which provides additional information at a glance.

The filter function modifies the test IDs that appear to streamline operations on large projects.

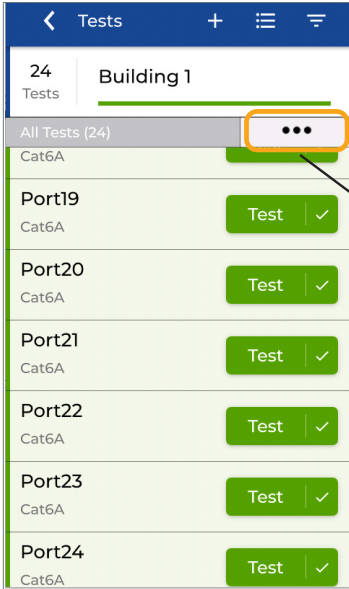

Open a job to view the list of tests.

By default the test standard used is displayed under each identifier - and all the tests in the job are listed one below the other.

Press the Options button to change the information displayed on the second line of each test.

Select the desired measurement to display in the list of tests.

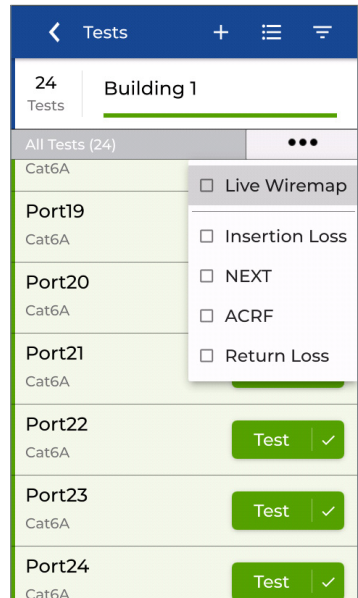

Live wiremap

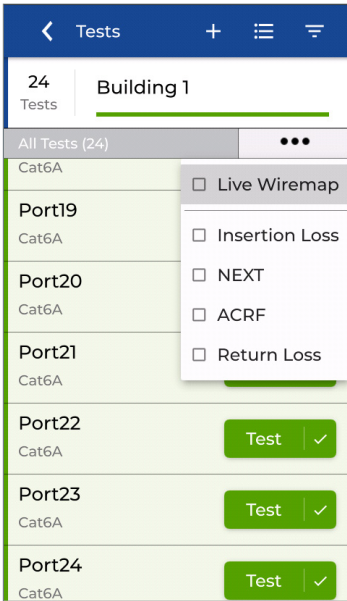

Select Live wiremap to display a real-time measurement of cable continuity.

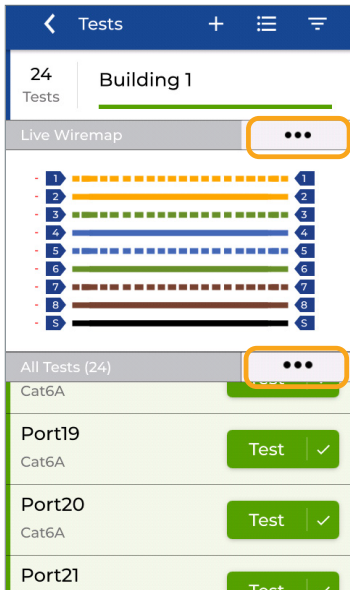

Live wiremap allows a check of continuity before performing the Autotest.

With Live wiremap active the upper options button changes the wiremap color code display.

The lower options button deactivates the Wiring Diagram or modifies the value displayed on the second line of the name of each test.

Filtering display of test results

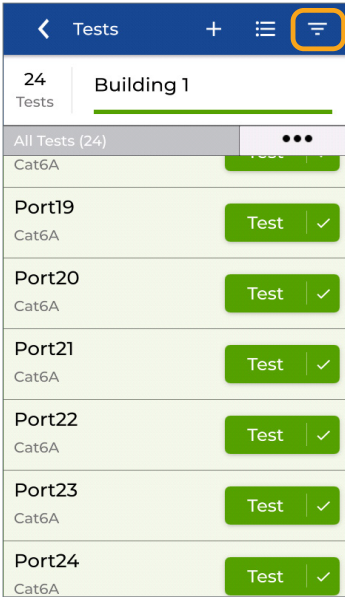

Press the filter button to display only the desired tests in the current folder.

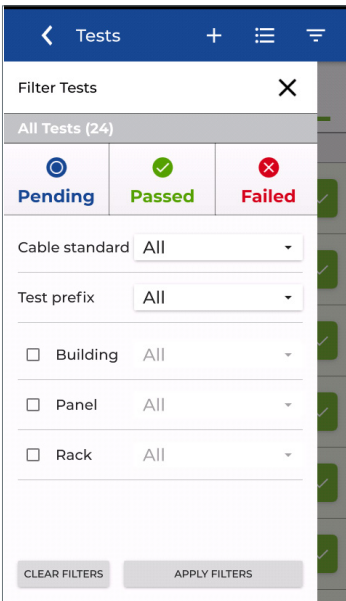

It is possible with the three buttons at the top of the screen to filter the tests that you want to display: Untested, Passed, or Failed results.

The tests in the folder will be filtered if the corresponding status box is colored. If you press one of the buttons the icon turns gray and hides test results matching that status.

For example, pressing Passed changes the button from green to gray, which means that passed tests will be hidden, while failed and unmeasured tests will be displayed when the filter is applied.

Press Apply Filters to confirm the choices - or Clear Filters to deactivate filtering and display all tests.

Filtering display of test results

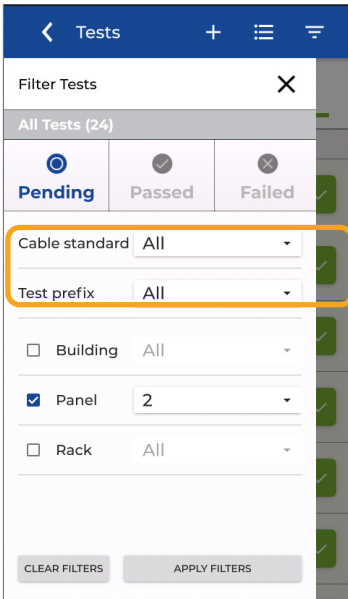

The other filter tools allow sorting according to the test standard, and/or the prefix of the test name, and/or the test identifiers as desired.

Multiple filters can be selected to narrow the tests displayed in the home screen.

In this example Panel 02 is selected and only the test ID's for Panel 02 will be displayed.

Press Apply Filters to confirm the selection.

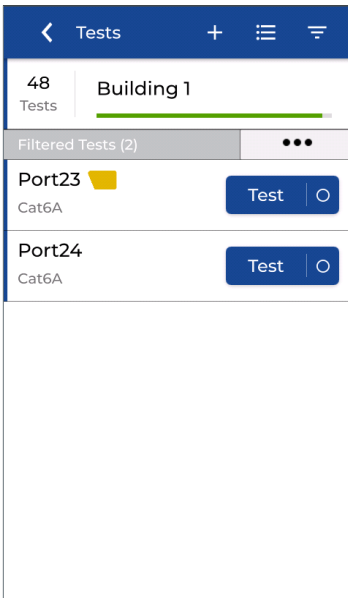

The list of sorted tests dedicated only to Panel 02 will be presented.

Return to the Filter screen and tap Clear Filters to remove them and view all tests again.

Jobs management and synchronization

Manage Jobs

Press JOBS to view the list jobs.

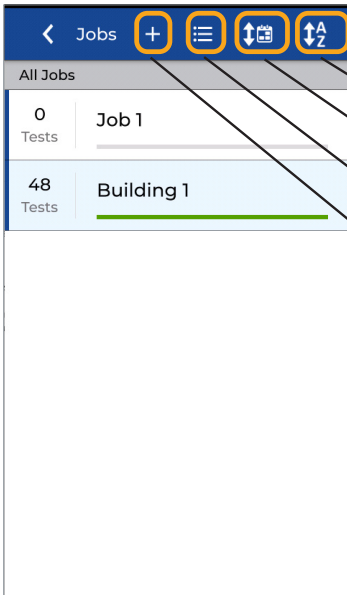
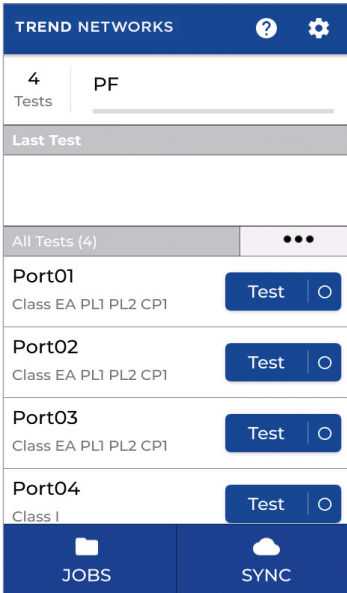

Sort the list of jobs alphabetically.

Sort jobs by creation date.

Select multiple jobs.

Create a new job.

Job management and synchronization

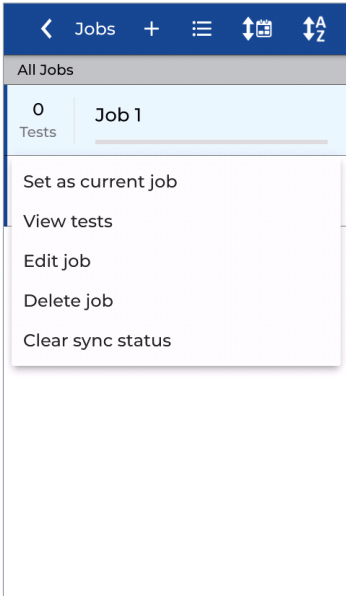

Long-press a job to open the options menu.

The active job cannot be deleted. To delete the active job, first long-press the name of a different job to open the options menu.

Press Set as current job to make it the active job.

Then long-press the job to be deleted. The options menu including the option to delete the folder and all test results is now available.

Please note that job deletion is permanent and cannot be canceled, all included tests will be lost.

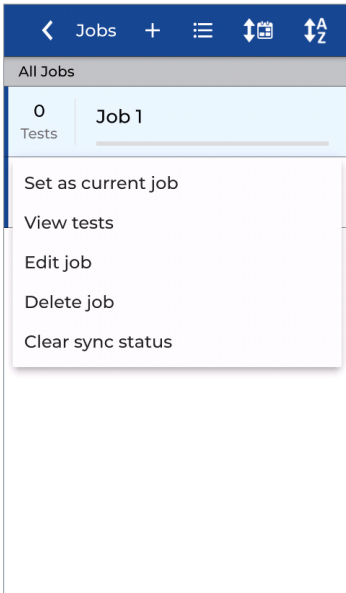

When a folder has been synced to the cloud or to a USB drive, it cannot be synced again without clearing the sync status.

Tap Clear sync status in the folders options to allow the folder to sync again. This may be necessary when a folder has been synchronized with the cloud and another copy is desired on a USB stick.

Job management and synchronization

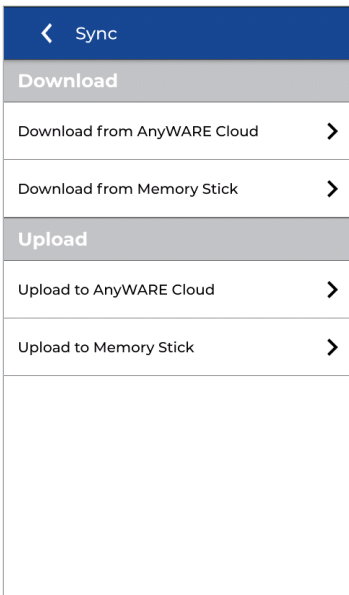
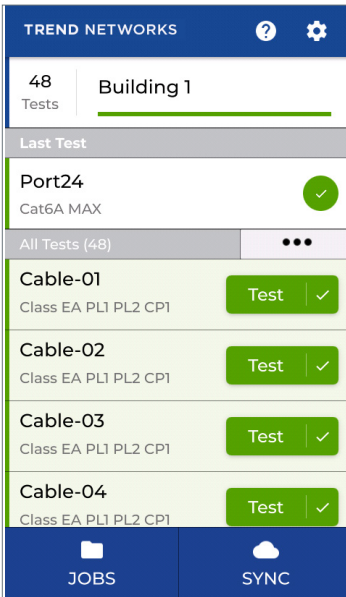

File synchronization

Folders can be synchronized between LanTEK IV and AnyWARE Cloud or Desktop software using Wi-Fi or a USB memory stick.

Once a folder has been synchronized, only the new tests will be synchronized unless the “Clear sync status” button is pressed to reset the job.

Press SYNC to open the import & export synchronization options screen.

Import transfers files and tests to be done from AnyWARE Cloud or Desktop to LanTEK IV for pre-configured tests in advance.

Importing from AnyWARE Cloud checks the associated Cloud account and allows you to import all untested files or to select specific jobs to import.

Import from USB allows you to import folders created on AnyWARE Desktop and exported to USB.

Folder management and synchronization

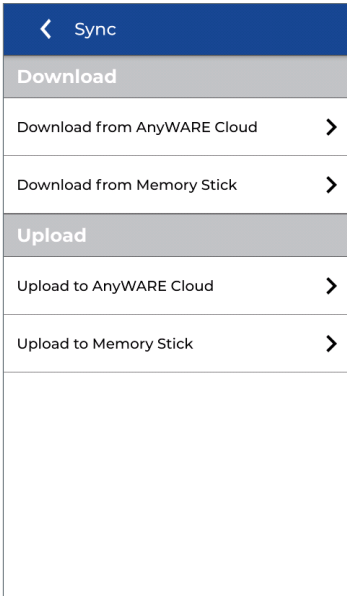

Export files containing completed tests to AnyWARE Cloud or AnyWARE Desktop.

Export to AnyWARE Cloud is only available with active Wi-Fi. Selecting this option will synchronize all folders and tests not previously synchronized with the Cloud account associated to the LanTEK IV.

Press "Upload to AnyWARE Cloud" to synchronize all tests to the Cloud software.

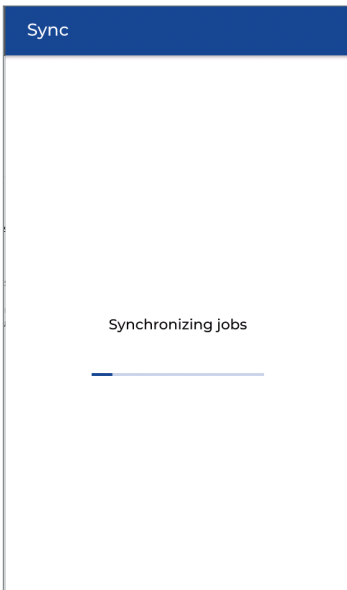

Wi-Fi will turn on automatically if it is turned off when Upload to AnyWARE Cloud is selected.

The progress indicator will move from left to right to indicate the progress of synchronization.

Folder management and synchronization

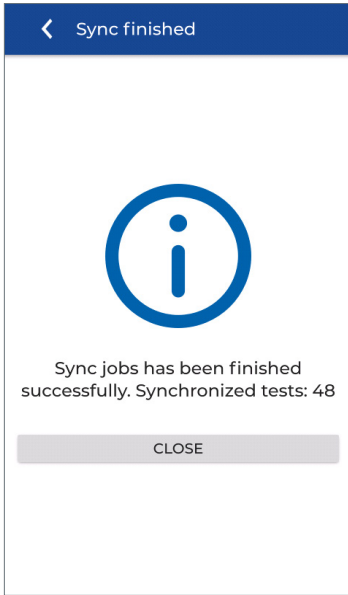

Synchronization complete with the number of tests transferred.

USB flash drive key requirements:
Supported format - FAT32
Supported size - up to 512GB

Storage capacity:
Cat 6A/Class EA tests - 4000 tests per GB of storage space
Cat 8/Class I/II tests - 2000 tests per GB of storage space

Technical specifications of cable certifiers

LanTEK IV-500: Ref. R163000 - 500MHz

LanTEK IV-3000: Ref. R163001 - 3000MHz

Batteries

- Removable, interchangeable, rechargeable Lithium-Ion, 7.4V, 6.6Ah, 48.8Wh.
- Charge time - 8 hours in handset, 4 hours using external charging port.
- Typical run time - 8 hours
- Mains operation - handsets can operate from mains power with or without battery installed.

Screen: IPS capacitive color touchscreen, 480x854 pixels, 5 " (12.7mm)

Weight of a handset with battery: 1.1 kg

Dimensions: 25.4 x 12.7 x 5.3cm

Operating temperature: 0 to + 45 ° C, non-condensing

Storage temperature : -20 to + 70 ° C, non-condensing

Vibration / shock: MIL-PRF-28800 F, Class 3 (by design)

User interface: English, French, German, Spanish, Italian, Portuguese, Polish, Russian, Chinese, Japanese

Internal memory: non-volatile flash with a capacity of 2500 tests with plots and troubleshooting data

Interfaces

- 2.4/5 GHz Wi-Fi - 801.11 b/g/n
- USB C (USB 2.0) & USB A (USB 2.0)
- 3.5mm headset jack

Data export

- USB memory key, up to 512GB
- Cloud via Wi-Fi

Project management software, for import & export

- TREND AnyWARE Cloud: cloud version which requires an HTML 5 compatible browser on Windows, Mac, Linux, and mobile devices (Android/iOS)
- TREND AnyWARE Desktop: computer version requires - Microsoft Windows 10, 2 GB RAM, 500 MB of disk storage + 1GB of storage for approximately for 1500 category 6/Class E tests
- All measurement points are saved in the devices and then transferred to the software. Full analysis of plot data available in cloud and desktop versions of TREND AnyWARE
- Re-certification to different test standards available for limits up to 500 MHz (LanTEK IV 500) or 3000 MHz (LanTEK IV 3000)

Supported cabling/test limits

- ANSI/TIA: Cat. 3, 5e, 6, 6A and 8.1/8.2 (100Ω)
- ISO/IEC: Class C, D, E, EA, F, FA, I/II (100Ω)
- Fiber optic via optional FiberTEK IV modules: multimode from OM1 to OM5 and single mode OS1-OS2

Supported test connectors

- RJ45 Permanent Link: TIA Cat. 6A / ISO Class EA up to 500 MHz (LanTEK IV 500)
- RJ45 Permanent Link: TIA Cat. 8.1 / ISO Class I up to 2000 MHz (LanTEK IV 3000)
- Field replaceable heads on RJ45 permanent link adapters, recommended replacement interval every 2000 insertions
- RJ45 Channel: TIA Cat. 6A / ISO Class EA up to 500 MHz (LanTEK IV 500)
- RJ45 Channel: TIA Cat. 8.1 / ISO Class I up to 2000 MHz (LanTEK IV 3000)
- TIA Cat 8.2/ISO Class FA/ Class II: TERA, GG45, EC7 universal adapters for permanent link and channel measurements
- Optional FiberTEK fiber adapters: interchangeable SC, ST and SC included, LC optional

Measurement time

- Certification for Class EA / Cat 6A up to 500 MHz with plots, DC resistance unbalance, TCL/ELTCTL, time domain NEXT/Return Loss: 7 seconds
- Certification for Class I/II, Cat 8 up to 3000 MHz with plots, DC resistance unbalance, TCL/ELTCTL, time domain NEXT/Return Loss: 25 seconds

Measurement details

- ETL verified to meet ANSI / TIA-1152-A Level 2G, IEC 61935-1 Level VI for 500 MHz and 3000 MHz models

User selectable optional measurements

- TCL, ELTCTL, resistance unbalance
- Time Domain NEXT - to locate distance to crosstalk events
- Time Domain Return Loss - to locate distance to impedance mismatch events
- Optional measurements do not increase test time

Measuring ranges

- Wiring diagram with distance to faults: resolution 10cm
- Length measurement: from 0 to 600m - display resolution: 0.1m
- Resistance measurement range: 0.02 to 200 Ω - display resolution: 0.1 Ω
- Propagation delay measurement range: 1ns to 1s - display resolution: 1ns
- RF measurement details: ISO / IEC 61935-1 Ed 5, ANSI / TIA-1152-A - display resolution: 0.1dB

Standard warranty

- 12 months for handsets and accessories
- 6 months for batteries
- Optional Sapphire Care Plan service contracts for extended warranties and calibration for 1, 2, and 3 year terms

Compliance

- IEC 61010-1: 2010 Ed 3 - Safety requirements for electrical equipment for measurement, control and laboratory use
- EN61326-1: 2013 - Electrical equipment for measurement, control and laboratory use. EMC requirements.
- EN55011: 2009 + A2: 2010 - Industrial, scientific and medical equipment. Radio frequency disturbance characteristics.
- EN61000-4-2: 2009 - Electrostatic Discharge Immunity Test
- EN61000-4-3: 2006 + A2: 2010 - Radiated, radio-frequency, electromagnetic field immunity test
- EN61000-4-4: 2004 + A1: 2010 - Electrical Fast Transient / Burst Immunity Test
- EN61000-4-5: 2006 - Surge Immunity Test
- EN61000-4-6: 2009 - Immunity to conducted disturbances, induced by radio-frequency fields
- EN61000-4-11: 2004 - Voltage dips, short interruptions and voltage variations immunity tests

- Devices: CE, C-Tick, FCC Part 15, Class A
- Batteries: DOT 49 CFR 173.185, UN Part IV - section 38.3

Notes:



TREND NETWORKS, LanTEK, FiberTEK, VisiLINQ and the TREND AnyWARE logos are trademarks or registered trademarks of TREND NETWORKS.

TREND NETWORKS
Stokenchurch House, Oxford Road, Stokenchurch,
High Wycombe, Buckinghamshire, HP14 3SX, UK.

Phone. +44 (0) 1925 428 380 | Fax. +44 (0) 1925
428 381

uksales@trend-networks.com

www.trend-networks.com



Specification subject to change without notice.

E&OE

© TREND NETWORKS 2020