



Power Master
MI 2892
Instruction manual
Version 1.0, Code No. 20 752 217

Distributor:

Manufacturer:

METREL d.d.
Ljubljanska cesta 77
1354 Horjul
Slovenia

web site: <http://www.metrel.si>
e-mail: metrel@metrel.si



Mark on your equipment certifies that this equipment meets the requirements of the EU (European Union) concerning safety and interference causing equipment regulations

© 2013 METREL

No part of this publication may be reproduced or utilized in any form or by any means without permission in writing from METREL.

1	Introduction.....	7
1.1	Main Features	7
1.2	Safety considerations	8
1.3	Applicable standards	9
1.4	Abbreviations.....	10
2	Description.....	19
2.1	Front panel	19
2.2	Connector panel	20
2.3	Bottom view.....	21
2.4	Accessories.....	21
2.4.1	Standard accessories.....	21
2.4.2	Optional accessories	21
3	Operating the instrument.....	22
3.1	Instrument status bar.....	23
3.2	Instrument keys	24
3.3	Instrument memory (microSD card)	24
3.4	Instrument Main Menu.....	25
3.4.1	Instrument submenus.....	26
3.5	U, I, f.....	28
3.5.1	Meter.....	28
3.5.2	Scope	30
3.5.3	Trend.....	32
3.6	Power	34
3.6.1	Meter.....	34
3.6.2	Trend.....	36
3.7	Energy.....	39
3.7.1	Meter.....	39
3.7.2	Trend.....	40
3.8	Harmonics / interharmonics	41
3.8.1	Meter.....	41
3.8.2	Histogram (Bar).....	43
3.8.3	Trend.....	45
3.9	Flickers.....	47
3.9.1	Meter.....	47
3.9.2	Trend.....	48
3.10	Phase Diagram.....	50
3.10.1	Phase diagram	50
3.10.2	Unbalance diagram	51
3.10.3	Unbalance trend	52
3.11	Temperature.....	53
3.11.1	Meter.....	53
3.11.2	Trend.....	54
3.12	Signalling.....	54
3.12.1	Meter.....	55
3.12.2	Trend.....	56
3.13	General Recorder.....	57
3.14	Waveform/inrush recorder	58
3.14.1	Setup.....	58
3.14.2	Capturing waveform	59
3.14.3	Captured waveform	61

3.15	Transient recorder	62
3.15.1	Setup	62
3.15.2	Capturing transients	63
3.15.3	Captured transients	65
3.16	Events table	66
3.17	Alarms table	70
3.18	Memory List	72
3.18.1	General Record	73
3.18.2	Waveform snapshot	76
3.18.3	Waveform/inrush record	78
3.18.4	Transients record	78
3.19	Measurement Setup submenu	78
3.19.1	Connection setup	79
3.19.2	Event setup	82
3.19.3	Alarm setup	82
3.19.4	Signalling setup	84
3.20	General Setup submenu	84
3.20.1	Communication	85
3.20.2	Time & Date	86
3.20.3	Language	87
3.20.4	Instrument info	88
3.20.5	Lock/Unlock	88
3.20.6	Colour model	90
4	Recording Practice and Instrument Connection	92
4.1	Measurement campaign	92
4.2	Connection setup	96
4.2.1	Connection to the LV Power Systems	96
4.2.2	Connection to the MV or HV Power System	100
4.2.3	Current clamp selection and transformation ratio setting	101
4.2.4	Temperature probe connection	105
4.2.5	GPS time synchronization device connection	105
4.3	Remote instrument connection (over Internet)	106
4.3.1	Communication principle	106
4.3.2	Instrument setup on remote measurement site	107
4.3.3	PowerView setup for instrument remote access	108
4.3.4	Remote connection	110
4.4	Number of measured parameters and connection type relationship	121
5	Theory and internal operation	123
5.1	Measurement methods	123
5.1.1	Measurement aggregation over time intervals	123
5.1.2	Voltage measurement (magnitude of supply voltage)	123
5.1.3	Current measurement (magnitude of supply current)	124
5.1.4	Frequency measurement	125
5.1.5	Power measurement (Standard compliance: IEEE 1459-2010)	125
5.1.6	Energy	131
5.1.7	Harmonics and interharmonics	132
5.1.8	Signalling	134
5.1.9	Flickers	135
5.1.10	Voltage and current unbalance	136
5.1.11	Voltage events	136

5.1.12	Alarms	139
5.1.13	Data aggregation in GENERAL RECORDING	139
5.1.14	Waveform snapshot	142
5.1.15	Waveform record.....	143
5.1.16	Transient recorder	144
5.2	EN 50160 Standard Overview	145
5.2.1	Power frequency	145
5.2.2	Supply voltage variations	146
5.2.3	Supply voltage unbalance	146
5.2.4	THD voltage and harmonics.....	146
5.2.5	Interharmonic voltage.....	146
5.2.6	Mains signalling on the supply voltage.....	147
5.2.7	Flicker severity	147
5.2.8	Voltage dips	147
5.2.9	Voltage swells	148
5.2.10	Short interruptions of the supply voltage	148
5.2.11	Long interruptions of the supply voltage.....	148
5.2.12	Power Master recorder setting for EN 50160 survey.....	148
6	Technical specifications	149
6.1	General specifications	149
6.2	Measurements.....	149
6.2.1	General description	149
6.2.2	Phase Voltages	150
6.2.3	Line voltages	150
6.2.4	Current	151
6.2.5	Frequency	152
6.2.6	Flickers.....	152
6.2.7	Combined power	153
6.2.8	Fundamental power.....	153
6.2.9	Nonfundamental power	154
6.2.10	Power factor (PF)	155
6.2.11	Displacement factor (DPF) or Cos ϕ	155
6.2.12	Energy.....	155
6.2.13	Voltage harmonics and THD	155
6.2.14	Current harmonics and THD	156
6.2.15	Voltage interharmonics.....	156
6.2.16	Current interharmonics.....	156
6.2.17	Signalling.....	156
6.2.18	Unbalance	156
6.2.19	Time and duration uncertainty.....	157
6.2.20	Temperature probe.....	157
6.3	Recorders.....	158
6.3.1	General recorder	158
6.3.2	Waveform/inrush recorder.....	158
6.3.3	Waveform snapshot	159
6.3.4	Transients recorder	159
6.4	Standards compliance.....	159
6.4.1	Compliance to the IEC 61557-12	159
6.4.2	Compliance to the to the IEC 61000-4-30	160

7	Maintenance	161
7.1	Inserting batteries into the instrument	161
7.2	Batteries	162
7.3	Power supply considerations.....	163
7.4	Cleaning	164
7.5	Periodic calibration	164
7.6	Service	164
7.7	Troubleshooting.....	164

1 Introduction

Power Master is handheld multifunction instrument for power quality analysis and energy efficiency measurements.



Figure 1.1: Power Master instrument

1.1 Main Features

- Full compliance with power quality standard IEC 61000-4-30 Class A.
- Simple and powerful recorder with microSD memory card (sizes up to 32 GB are supported).
- 4 voltage channels with wide measurement range: up to 1000 Vrms, CAT III / 1000 V, with support for medium and high voltage systems.
- Simultaneous voltage and current (8 channels) sampling, 16 bit AD conversion for accurate power measurements and minimal phase shift error.
- 4 current channels with support for automatic clamp recognition and range selection.
- Compliance with IEC 61557-12 and IEEE 1459 (Combined, fundamental, nonfundamental power) and IEC 62053-22 (Energy).

- 4.3" TFT colour display, easy internet remote access over Ethernet.
- Waveform/inrush recorder, which can be triggered on event or alarms, and run simultaneously with general recorder.
- Powerful troubleshooting tools: transient recorder with envelope and level triggering.
- PC Software **PowerView v3.0** is an integral part of a measuring system which provides easiest way to download, view and analyse measured data or print reports.
 - PowerView v3.0 analyser exposes a simple but powerful interface for downloading instrument data and getting quick, intuitive and descriptive analysis. Interface has been organized to allow quick selection of data using a Windows Explorer-like tree view.
 - User can easily download recorded data, and organize it into multiple sites with many sub-sites or locations.
 - Generate charts, tables and graphs for your power quality data analysing, and create professional printed reports.
 - Export or copy / paste data to other applications (e.g. spreadsheet) for further analysis.
 - Multiple data records can be displayed and analysed simultaneously. Merge different logging data into one measurement, synchronize data recorded with different instruments with time offsets, split logging data into multiple measurements, or extract data of interest.

1.2 Safety considerations

To ensure operator safety while using the Power Master instruments and to minimize the risk of damage to the instrument, please note the following general warnings:



The instrument has been designed to ensure maximum operator safety. Usage in a way other than specified in this manual may increase the risk of harm to the operator!



Do not use the instrument and/or accessories if any visible damage is noticed!



The instrument contains no user serviceable parts. Only an authorized dealer can carry out service or adjustment!



All normal safety precautions have to be taken in order to avoid risk of electric shock when working on electrical installations!





Only use approved accessories which are available from your distributor!



Instrument contains rechargeable NiMH batteries. The batteries should only be replaced with the same type as defined on the battery placement label or in this manual. Do not use standard batteries while power supply adapter/charger is connected, otherwise they may explode!



Hazardous voltages exist inside the instrument. Disconnect all test leads, remove the power supply cable and switch off the instrument before removing battery compartment cover.

-  **Maximum nominal voltage between any phase and neutral input is 1000 V_{RMS}. Maximum nominal voltage between phases is 1730 V_{RMS}.**
-  **Always short unused voltage inputs (L1, L2, L3, GND) with neutral (N) input to prevent measurement errors and false event triggering due to noise coupling.**
-  **Do not remove microSD memory card while instrument is recording or reading data. Record damage and card failure can occur.**

1.3 Applicable standards

The Power Master are designed and tested in accordance with the following standards:

Electromagnetic compatibility(EMC)

EN 61326-2-2: 2013

Electrical equipment for measurement, control and laboratory use – EMC requirements – Part 2-2: Particular requirements - Test configurations, operational conditions and performance criteria for portable test, measuring and monitoring equipment used in low-voltage distribution systems

- Emission: Class A equipment (for industrial purposes)
- Immunity for equipment intended for use in industrial locations

Safety (LVD)

EN 61010-1: 2010

Safety requirements for electrical equipment for measurement, control and laboratory use – Part 1: General requirements

EN 61010-2-030: 2010

Safety requirements for electrical equipment for measurement, control and laboratory use – Part 2-030: Particular requirements for testing and measuring circuits

EN 61010-031: 2002 + A1: 2008

Safety requirements for electrical equipment for measurement, control and laboratory use – Part 031: Safety requirements for hand-held probe assemblies for electrical measurement and test

EN 61010-2-032: 2012

Safety requirements for electrical equipment for measurement, control and laboratory use Part 031: Safety requirements for hand-held probe assemblies for electrical measurement and test

Measurement methods

IEC 61000-4-30: 2008 Class A

Part 4-30: Testing and measurement techniques – Power quality measurement methods

IEC 61557-12: 2007

Equipment for testing, measuring or monitoring of protective measures – Part 12: Performance measuring and monitoring devices (PMD)

IEC 61000-4-7: 2002 + A1: 2008

Part 4-7: Testing and measurement techniques –

IEC 61000-4-15 : 2010	General guide on harmonics and interharmonics measurements and instrumentation for power supply systems and equipment connected thereto Part 4-15: Testing and measurement techniques – Flickermeter – Functional and design specifications
IEC 62053-22 : 2003	Part 22: Static meters for active energy (Class 0.5S)
IEC 62053-23 : 2003	Part 22: Part 23: Static meters for reactive energy (Class 2)
IEEE 1459 : 2010	IEEE Standard Definitions for the Measurement of Electric Power Quantities Under Sinusoidal, Nonsinusoidal, Balanced, or Unbalanced Conditions
EN 50160 : 2010	Voltage characteristics of electricity supplied by public electricity networks

Note about EN and IEC standards:

Text of this manual contains references to European standards. All standards of EN 6XXXX (e.g. EN 61010) series are equivalent to IEC standards with the same number (e.g. IEC 61010) and differ only in amended parts required by European harmonization procedure.

1.4 Abbreviations

In this document following symbols and abbreviations are used:

CF_I	Current crest factor, including CF_{Ip} (phase p current crest factor) and CF_{IN} (neutral current crest factor). See 5.1.3 for definition.
CF_U	Voltage crest factor, including CF_{Upg} (phase p to phase g voltage crest factor) and CF_{Up} (phase p to neutral voltage crest factor). See 5.1.2 for definition.
$\pm DPF_{ind/cap}$	Instantaneous phase power displacement (fundamental) power factor or $\cos \varphi$, including $\pm DPF_{p_{ind}}$ (phase p power displacement). Minus sign indicates generated power and plus sign indicates consumed power. Suffix <i>ind/cap</i> represents inductive/capacitive character.

Recorded phase displacement (fundamental) power factor or $\cos \varphi$, including $DPF_{p\text{ind/cap}}^{\pm}$ (phase p power displacement).

$DPF_{\text{ind/cap}}^{\pm}$

Minus sign indicates generated power and plus sign indicates consumed power. Suffix *ind/cap* represents inductive/capacitive character. This parameter is recorded separately for each quadrant as shown on figure. See 5.1.5 for definition.

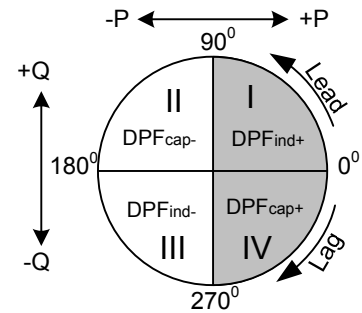

Instantaneous positive sequence fundamental power factor.

$\pm DPF_{\text{totind}}^+$

$\pm DPF_{\text{totcap}}^+$

Minus sign indicates generated power and plus sign indicates consumed power. Suffix *ind/cap* represents inductive/capacitive character. See 5.1.5 for definition.

Recorded total effective fundamental power factor.

$DPF_{\text{totind}}^{\pm}$

$DPF_{\text{totcap}}^{\pm}$

Minus sign indicates generated power and plus sign indicates consumed power. Suffix *ind/cap* represents inductive/capacitive character. This parameter is recorded separately as shown on figure. See 5.1.5 for definition.

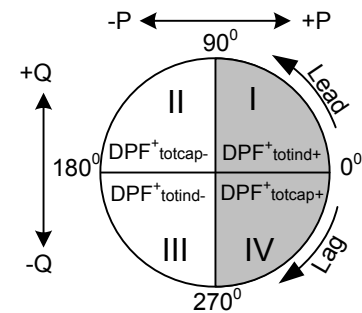

DI

Phase current distortion power, including DI_p (phase p current distortion power). See 5.1.5 section: Power measurement (Standard compliance: IEEE 1459-2010) for definition.

DeI_{tot}

Total effective current distortion power. See 5.1.5 section: Power measurement (Standard compliance: IEEE 1459-2010) for definition.

DH

Phase harmonics distortion power, including DH_p (phase p harmonics distortion power). See 5.1.5 section: Power measurement (Standard compliance: IEEE 1459-2010) for definition.

DeH

Total effective harmonics distortion power. See 5.1.5 section: Total nonfundamental power measurements for definition.

Dv

Phase voltage distortion power, including Dv_p (phase p voltage distortion power). See 5.1.5 section: Power measurement (Standard compliance: IEEE 1459-2010) for definition.

Dev_{tot}

Total effective voltage distortion power. See 5.1.5

	section: Power measurement (Standard compliance: IEEE 1459-2010) for definition.
E_p^\pm	Recorded phase combined (fundamental and nonfundamental) active energy, including $E_{p_p}^{+/-}$ (phase p active energy). Minus sign indicates generated energy and plus sign indicates consumed energy. See 5.1.6 for definition.
$E_{p_{tot}}^\pm$	Recorded total combined (fundamental and nonfundamental) active energy. Minus sign indicates generated and plus sign indicates consumed energy. See 5.1.6 for definition.
E_q^\pm	Recorded phase fundamental reactive energy, including $E_{q_p}^{+/-}$ (phase p reactive energy). Minus sign indicates generated and plus sign indicates consumed energy. See 5.1.6 for definition.
$E_{q_{tot}}^\pm$	Recorded total fundamental reactive energy. Minus sign indicates generated and plus sign indicates consumed energy. See 5.1.6 for definition.
$f, freq$	Frequency, including $freq_{U_{12}}$ (voltage frequency on U_{12}), $freq_{U_1}$ (voltage frequency on U_1 and $freq_{I_1}$ (current frequency on I_1). See 5.1.4 for definition.
\tilde{i}	Negative sequence current ratio (%). See 5.1.10 for definition.
i^0	Zero sequence current ratio (%). See 5.1.10 for definition.
I^+	Positive sequence current component on three phase systems. See 5.1.10 for definition.
I^-	Negative sequence current component on three phase systems. See 5.1.10 for definition.
i^0	Zero sequence current components on three phase systems. See 5.1.10 for definition.
$I_{Rms\frac{1}{2}}$	RMS current measured over each half period , including $I_{pRms\frac{1}{2}}$ (phase p current), $I_{NRms\frac{1}{2}}$ (neutral RMS current)
I_{fund}	Fundamental RMS current I_{h_1} (on 1 st harmonics), including I_{fund_p} (phase p fundamental RMS current) and I_{fund_N} (neutral RMS fundamental current). See 5.1.7 for definition
I_{h_n}	n^{th} current RMS harmonic component including $I_{p h_n}$ (phase p; n^{th} RMS current harmonic component) and $I_{N h_n}$ (neutral n^{th} RMS current harmonic component). See 5.1.7 for definition
I_{ih_n}	n^{th} current RMS interharmonic component including $I_{p ih_n}$ (phase p; n^{th} RMS current interharmonic component) and $I_{N ih_n}$ (neutral n^{th} RMS current interharmonic component). See 5.1.7 for definition

I_{Nom}	Nominal current. Current of clamp-on current sensor for 1 Vrms at output.	
I_{Pk}	Peak current, including I_{pPk} (phase p current) including I_{NPK} (neutral peak current)	
I_{Rms}	RMS current, including I_{pRms} (phase p current), I_{NRms} (neutral RMS current). See 5.1.3 for definition.	
$\pm P$	Instantaneous phase active combined (fundamental and nonfundamental) power, including $\pm P_p$ (phase p active power). Minus sign indicates generated and plus sign indicates consumed power. See 5.1.5 for definitions.	
P^\pm	Recorded phase active (fundamental and nonfundamental) power, including P_p^\pm (phase p active power). Minus sign indicates generated and plus sign indicates consumed power. See 5.1.5 for definitions.	
$\pm P_{tot}$	Instantaneous total active combined (fundamental and nonfundamental) power. Minus sign indicates generated and plus sign indicates consumed power. See 5.1.5 for definitions.	
P_{tot}^\pm	Recorded total active (fundamental and nonfundamental) power. Minus sign indicates generated and plus sign indicates consumed power. See 5.1.5 for definitions.	
$\pm P_{fund}$	Instantaneous active fundamental power, including $\pm P_{fund_p}$ (phase p active fundamental power). Minus sign indicates generated and plus sign indicates consumed power. See 5.1.5 for definitions.	
P_{fund}^\pm	Recorded phase active fundamental power, including $P_{fund_p}^\pm$ (phase p active fundamental power). Minus sign indicates generated and plus sign indicates consumed power. See 5.1.5 for definitions.	
$\pm P^+, \pm P_{tot}^+$	Instantaneous positive sequence of total active fundamental power. Minus sign indicates generated and plus sign indicates consumed power. See 5.1.5 for definitions.	
$P_{tot}^{+\pm}$	Recorded positive sequence of total active fundamental power. Minus sign indicates generated and plus sign indicates positive sequence of consumed power. See 5.1.5 for definitions.	

$\pm P_H$	Instantaneous phase active harmonic power, including $\pm P_{Hp}$ (phase p active harmonic power). Minus sign indicates generated and plus sign indicates consumed power. See 5.1.5 for definitions.	
P_H^\pm	Recorded phase active harmonics power, including P_{Hp}^\pm (phase p active harmonic power). Minus sign indicates generated and plus sign indicates consumed power. See 5.1.5 for definitions.	
$\pm P_{Htot}$	Instantaneous total active harmonic power. Minus sign indicates generated and plus sign indicates consumed power. See 5.1.5 for definitions.	
P_{Htot}^\pm	Recorded total active harmonics power. Minus sign indicates generated and plus sign indicates consumed active power. See 5.1.5 for definitions.	
$\pm PF_{ind}$ $\pm PF_{cap}$	Instantaneous phase combined (fundamental and nonfundamental) power factor, including $\pm PF_{pind/cap}$ (phase p power factor). Minus sign indicates generated power and plus sign indicates consumed power. Suffix <i>ind/cap</i> represents inductive/capacitive character.	
PF_{ind}^\pm PF_{cap}^\pm	Recorded phase combined (fundamental and nonfundamental) power factor. Minus sign indicates generated power and plus sign indicates consumed power. Suffix <i>ind/cap</i> represents inductive/capacitive character. This parameter is recorded separately for each quadrant as shown on figure.	
$\pm PF_{e_{totind}}$ $\pm PF_{e_{totcap}}$	Instantaneous total effective combined (fundamental and nonfundamental) power factor. Minus sign indicates generated power and plus sign indicates consumed power. Suffix <i>ind/cap</i> represents inductive/capacitive character. See 5.1.5 for definition.	

Recorded total effective combined (fundamental and nonfundamental) power factor.

$PF_{e_{totind}}^{\pm}$
 $PF_{e_{totcap}}^{\pm}$

Minus sign indicates generated power and plus sign indicates consumed power. Suffix *ind/cap* represents inductive/capacitive character. This parameter is recorded separately for each quadrant as shown on figure.

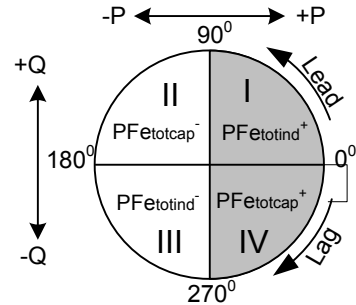

P_{lt} Phase long term flicker (2 hours), including P_{ltpg} (phase p to phase g long term voltage flicker) and P_{ltp} (phase p to neutral long term voltage flicker). See 5.1.9 for definition.

P_{st} Short term flicker (10 minutes) including P_{stpg} (phase p to phase g short term voltage flicker) and P_{stp} (phase p to neutral voltage flicker). See 5.1.9 for definition.

$P_{st(1min)}$ Short term flicker (1 minute) including $P_{st(1min)pg}$ (phase p to phase g short term voltage flicker) and $P_{st(1min)p}$ (phase p to neutral voltage flicker). See 5.1.9 for definition.

P_{inst} Instantaneous flicker including P_{instpg} (phase p to phase g instantaneous voltage flicker) and P_{instp} (phase p to instantaneous voltage flicker). See 5.1.9 for definition.

$\pm N$ Instantaneous combined (fundamental and nonfundamental) nonactive phase power including $\pm N_p$ (phase p nonactive phase power). Minus sign indicates generated and plus sign indicate consumed nonactive power. See 5.1.5 for definition.

Recorded phase combined (fundamental and nonfundamental) nonactive power including $N_{cap/indp}$ (phase p nonactive phase power). Suffix *ind/cap* represents inductive/capacitive character. Minus sign indicates generated and plus sign indicates consumed fundamental reactive power. This parameter is recorded separately for each quadrant as shown on figure. See 5.1.5 for definition.

N_{ind}^{\pm}
 N_{cap}^{\pm}

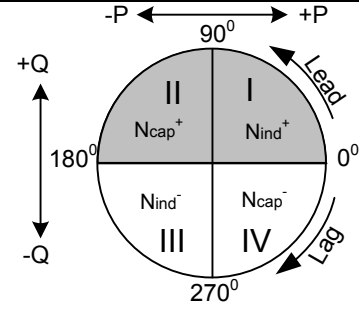

$\pm Q_{fund}$ Instantaneous fundamental reactive phase power including $\pm Q_p$ (phase p reactive phase power). Minus sign indicates generated and plus sign indicates consumed fundamental reactive power. See 5.1.5 for definition.

$Q_{fund_{ind}}^{\pm}$
 $Q_{fund_{cap}}^{\pm}$

Recorded phase fundamental reactive power. Suffix *ind/cap* represents inductive/capacitive character. Minus sign indicates generated and plus sign indicates consumed fundamental reactive power. This parameter is recorded separately for each quadrant as shown on figure. See 5.1.5 for definition.

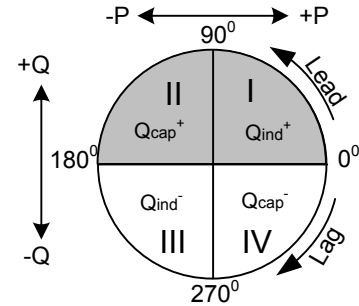

$\pm Q_{totcap}^+$
 $\pm Q_{totind}^+$

Instantaneous positive sequence of total fundamental reactive power. Suffix *ind/cap* represents inductive/capacitive character. Minus sign indicates generated and plus sign indicates consumed reactive power. See 5.1.5 for definition.

$Q_{totind}^{+\pm}$
 $Q_{totcap}^{+\pm}$

Recorded positive sequence of total fundamental reactive power. Suffix *ind/cap* represents inductive/capacitive character. Minus sign indicates generated and plus sign indicates consumed reactive power. This parameter is recorded separately for each quadrant.

S

Combined (fundamental and nonfundamental) phase apparent power including S_p (phase p apparent power). See 5.1.5 for definition.

Se_{tot}

Combined (fundamental and nonfundamental) total effective apparent power. See 5.1.5 for definition.

$Sfund$

Phase fundamental apparent power, including $Sfund_p$ (phase p fundamental apparent power). See 5.1.5 for definition.

S_{tot}^+

Positive sequence of total fundamental effective apparent power. See 5.1.5 for definition.

$Sfund_{tot}$

Unbalanced fundamental apparent power. See 5.1.5 for definition.

SN

Phase nonfundamental apparent power, including SN_p (phase p nonfundamental apparent power). See 5.1.5 for definition.

Sen

Total nonfundamental effective apparent power. See 5.1.5 for definition.

SH

Phase harmonic apparent power, including SH_p (phase p harmonic apparent power). See 5.1.5 for definition.

SeH_{tot}

Total harmonic effective apparent power. See 5.1.5 for definition.

THD_I

Total harmonic distortion current (in % or A), including THD_{Ip} (phase p current THD) and THD_{IN} (neutral current THD). See 5.1.7 for definition

THD_U	Total harmonic distortion voltage related (in % or V) including $THD_{U_{pg}}$ (phase p to phase g voltage THD) and THD_{U_p} (phase p to neutral voltage THD). See 5.1.10 for definition.
u^-	Negative sequence voltage ratio (%). See 5.1.10 for definition.
u^0	Zero sequence voltage ratio (%). See 5.1.10 for definition.
U, U_{Rms}	RMS voltage, including U_{pg} (phase p to phase g voltage) and U_p (phase p to neutral voltage). See 5.1.2 for definition.
U^+	Positive sequence voltage component on three phase systems. See 5.1.10 for definition.
U^-	Negative sequence voltage component on three phase systems. See 5.1.10 for definition.
U^0	Zero sequence voltage component on three phase systems. See 5.1.10 for definition.
U_{Dip}	Minimal $U_{Rms\frac{1}{2}}$ voltage measured during dip occurrence
U_{fund}	Fundamental RMS voltage (U_{h_1} on 1 st harmonics), including $U_{fund_{pg}}$ (phase p to phase g fundamental RMS voltage) and U_{fund_p} (phase p to neutral fundamental RMS voltage). See 5.1.7 for definition
U_{h_N}	n^{th} voltage RMS harmonic component including $U_{pg h_N}$ (phase p to phase g voltage n^{th} RMS harmonic component) and $U_p h_N$ (phase p to neutral voltage n^{th} RMS harmonic component). See 5.1.7 for definition.
U_{ih_N}	n^{th} voltage RMS interharmonic component including $U_{pg ih_N}$ (phase p to phase g voltage n^{th} RMS interharmonic component) and $U_p ih_N$ (phase p to neutral voltage n^{th} RMS interharmonic component). See 5.1.7 for definition.
	N^{th} RMS interharmonic voltage component measured between phases. See 5.1.7 for definition.
U_{Int}	Minimal $U_{Rms\frac{1}{2}}$ voltage measured during interrupt occurrence.
U_{Nom}	Nominal voltage, normally a voltage by which network is designated or identified.
U_{Pk}	Peak voltage, including $U_{pg Pk}$ (phase p to phase g voltage) and $U_p Pk$ (phase p to neutral voltage)
$U_{Rms\frac{1}{2}}$	RMS voltage refreshed each half-cycle, including $U_{pg Rms\frac{1}{2}}$ (phase p to phase g half-cycle voltage) and $U_p Rms\frac{1}{2}$ (phase p to neutral half-cycle voltage). See 5.1.11 for definition.

U_{Swell} Maximal $U_{Rms\frac{1}{2}}$ voltage measured during swell occurrence.

U_{Sig} Mains signalling RMS voltage, including U_{Sigpg} (phase p to phase g half-cycle signalling voltage) and U_{Sigp} (phase p to neutral half-cycle signalling voltage). Signalling is a burst of signals, often applied at a non-harmonic frequency, that remotely control equipment. See 5.2.6 for details.

2 Description

2.1 Front panel



Figure 2.1: Front panel

Front panel layout:

- | | |
|--|--|
| 1. LCD | Colour TFT display, 4.3 inch, 480 x 272 pixels. |
| 2. F1 – F4 | Function keys. |
| 3. ARROW keys | Moves cursor and select parameters. |
| 4. ENTER key | Step into submenu. |
| 5. ESC key | Exits any procedure, confirms new settings. |
| 6. SHORTCUT keys | Quick access to main instrument functions. |
| 7. LIGHT key
(BEEP OFF) | High intensity LCD backlight on/off
If the <i>LIGHT</i> key is pressed for more than 1.5 seconds, beeper will be disabled. Press & hold again to enable it. |

- | | |
|----------------------|---|
| 8. ON-OFF key | Turns on/off the instrument. |
| 9. COVER | Communication ports and microSD card slot protection. |

2.2 Connector panel

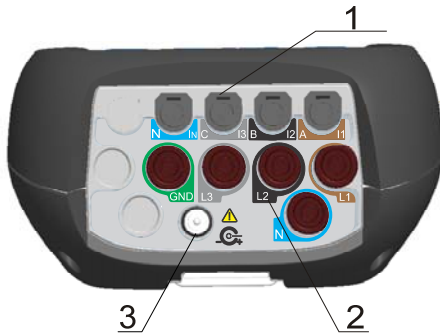

⚠ Warnings!

- ⚠ Use safety test leads only!
- ⚠ Max. permissible nominal voltage between voltage input terminals and ground is 1000 V_{RMS} !
- ⚠ Max. short-term voltage of external power supply adapter is 14 V!

Figure 2.2: Top connector panel

Top connector panel layout:

- 1 Clamp-on current transformers (I₁, I₂, I₃, I_N) input terminals.
- 2 Voltage (L₁, L₂, L₃, N, GND) input terminals.
- 3 12 V external power socket.

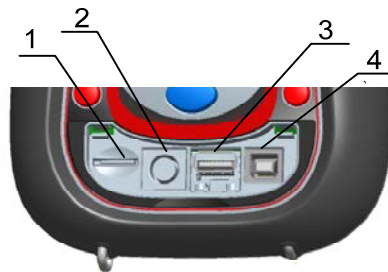

Figure 2.3: Side connector panel

Side connector panel layout:

- 1 MicroSD card slot.
- 2 PS/2 – RS232 / GPS serial connector.
- 3 Ethernet connector.
- 4 USB connector.

2.3 Bottom view

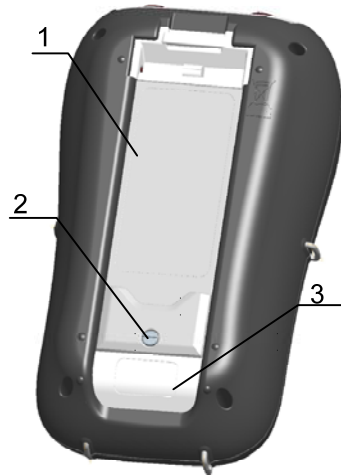

Figure 2.4: Bottom view

Bottom view layout:

1. Battery compartment cover.
2. Battery compartment screw (unscrew to replace the batteries).
3. Serial number label.

2.4 Accessories

2.4.1 Standard accessories

Table 2.1: Power Master standard accessories

Description	Pieces
Flexible current clamp 3000 A / 300 A / 30 A (A 1227)	4
Temperature probe (A 1354)	1
Colour coded test probe	5
Colour coded crocodile clip	5
Colour coded voltage measurement lead	5
USB cable	1
RS232 cable	1
Ethernet cable	1
12 V / 1.2 A Power supply adapter	1
NiMH rechargeable battery, type HR 6 (AA)	6
Soft carrying bag	1
Instruction manual	1
Compact disc (CD) with PowerView v3.0 and manuals	1

2.4.2 Optional accessories

See the attached sheet for a list of optional accessories that are available on request from your distributor.

3 Operating the instrument

This section describes how to operate the instrument. The instrument front panel consists of a colour LCD display and keypad. Measured data and instrument status are shown on the display. Basic display symbols and keys description is shown on figure below.



Figure 3.1: Display symbols and keys description

During measurement campaign various screens can be displayed. Most screens share common labels and symbols. These are shown on figure below.

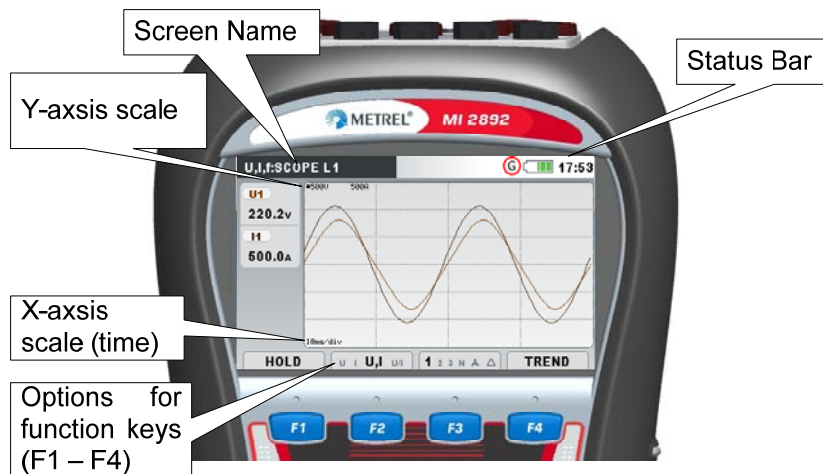

Figure 3.2: Common display symbols and labels during measurement campaign

















3.1 Instrument status bar

Instruments status bar is placed on the top of the screen. It indicates different instrument states. Icon descriptions are shown on table below.



Figure 3.3: Instrument status bar





Table 3.1: Instrument status bar description

	Indicates battery charge level.
	Indicates that charger is connected to the instrument. Batteries will be charged automatically when charger is present.
	Instrument is locked (see section 3.20.6 for details).
	AD converter over range. Selected Nominal voltage or current clamps range is too small.
09:19	Current time.
<u>GPS module status (Optional accessory A 1355):</u>	
	GPS module detected but reporting invalid time and position data. (Searching for satellites or too weak satellite signal).
	GPS time valid – valid satellite GPS time signal.
<u>Internet connection status (see section 4.3 for details):</u>	
	Internet connection is not available.
	Instrument is connected to the internet and ready for communication.
	Instrument is connected to the PowerView.
<u>Recorder status:</u>	
	General recorder is active, waiting for trigger.
	General recorder is active, recording in progress.
	Waveform recorder is active, waiting for trigger.
	Waveform recorder is active, recording in progress.
	Transient recorder is active, waiting for trigger.
	Transient recorder is active, recording in progress.
	Memory list recall. Shown screen is recalled from instrument memory.

3.2 Instrument keys









Instrument keyboard is divided into four subgroups:

- Function keys
- Shortcut keys
- Menu/zoom manipulation keys: Cursors, Enter, Escape
- Other keys: Light and Power on/off keys



Function keys     are multifunctional. Their current function is shown at the bottom of the screen and depends on selected instrument function.

Shortcut keys are shown in table below. They provide quick access to the most common instrument functions.

Table 3.2: Shortcut Keys functions

	Shows UIF Meter screen from MEASUREMENT submenu
	Shows Power meter screen from MEASUREMENT submenu
	Shows Harmonics meter screen from MEASUREMENT submenu
	Shows Connection Setup screen from MEASUREMENT SETUP submenu
	Shows Phase diagram screen from MEASUREMENT submenu
	Hold  key for 2 seconds to trigger WAVEFORM SNAPSHOT. Instrument will record all measured parameters into file, which can be then analysed by PowerView.
	Hold  key for 2 s to disable/enable sound signals.

Cursor, Enter and Escape keys are used for moving through instrument menu structure, entering various parameters. Additionally, cursor keys are used for zooming graphs and moving graph cursors.

 key is used to set backlight intensity (low/high). Additionally, by holding  key pressed, user can enable/disable beeper.

 key is used to switch On/off the instrument.

3.3 Instrument memory (microSD card)

Power master use microSD card for storing records. Prior instrument use, microSD card should be formatted to a single partition FAT32 file system and inserted into the instrument, as shown on figure below.

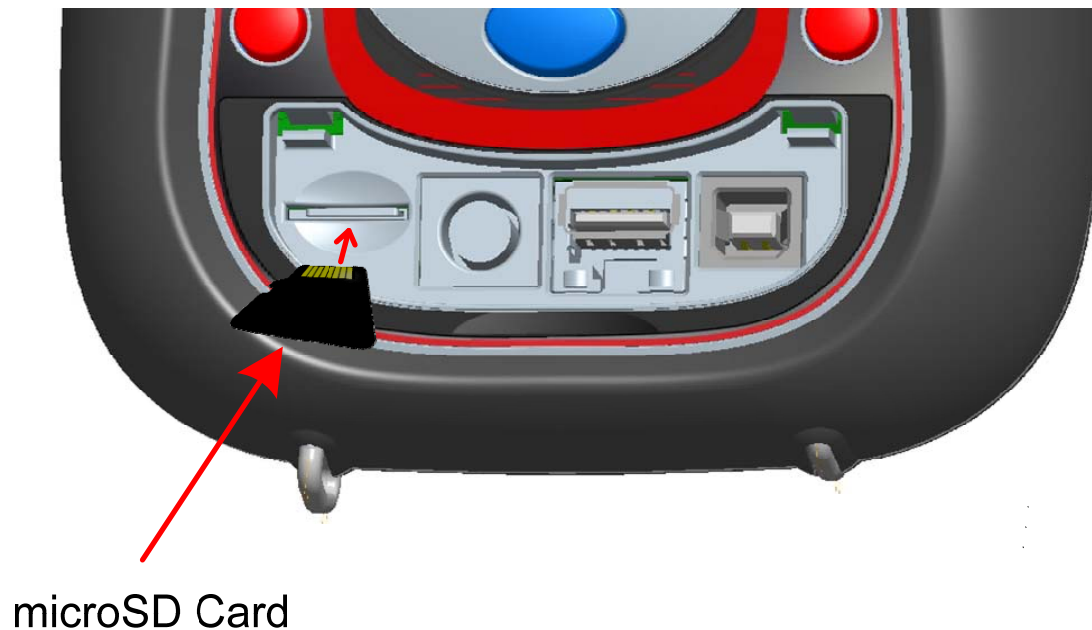

Figure 3.4: Inserting microSD card

1. Open instrument cover
2. Insert microSD card into a slot on the instrument (card should be putted upside down, as shown on figure)
3. Close instrument cover

Note: Do not turn off the instrument while microSD card is accessed:

- during record session
- observing recorded data in MEMORY LIST menu

Doing so may cause data corruption, and permanent data lost.

Note: SD Card should have single FAT32 partition. Do not use SD cards with multiple partitions.

3.4 Instrument Main Menu

After powering on the instrument the “MAIN MENU” is displayed. From this menu all instrument functions can be selected.

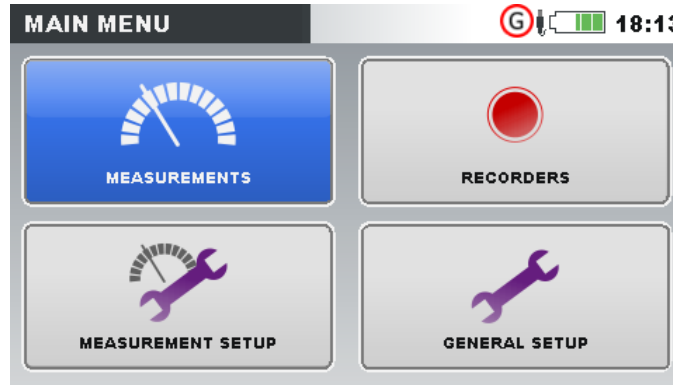

Figure 3.5: “MAIN MENU”

Table 3.3: Instrument Main menu







	MEASUREMENT submenu. Provide access to various instrument measurement screens
	RECORDER submenu. Provide access to instrument recorders configuration and storage.
	MEASUREMENT SETUP submenu. Provide access to the measurement settings.
	GENERAL SETUP submenu. Provide access to the various instrument settings.

Table 3.4: Keys in Main menu

	Selects submenu.
	Enters selected submenu.

3.4.1 Instrument submenus

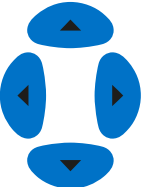
By pressing ENTER key in Main menu, user can select one of four submenus:

- Measurements – set of basic measurement screens,
- Recorders – setup and view of various recordings,
- Measurement setup – measurement parameters setup,
- General setup – configuring common instrument settings.

List of all submenus with available functions are presented on following figures.

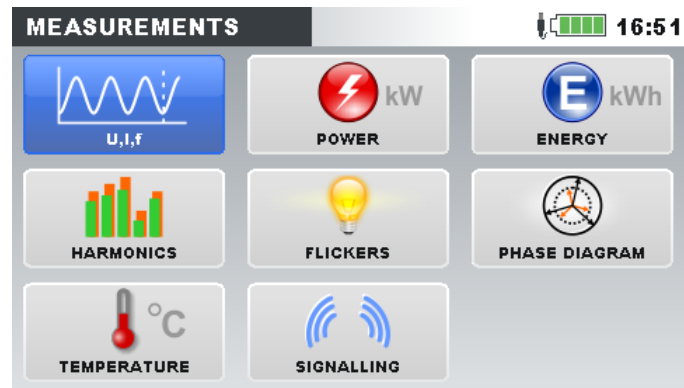

Figure 3.6: Measurements submenu

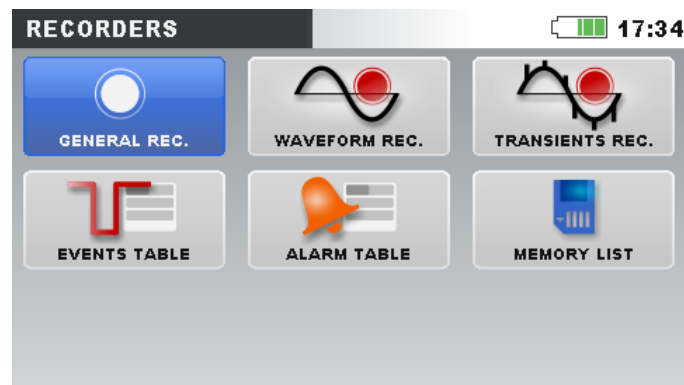

Figure 3.7: Recorders submenu

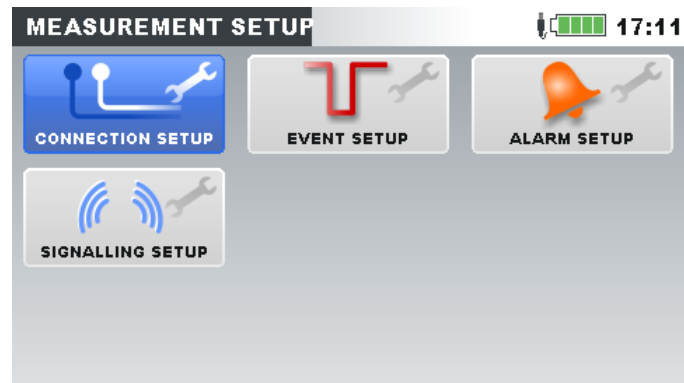

Figure 3.8: Measurement setup submenu

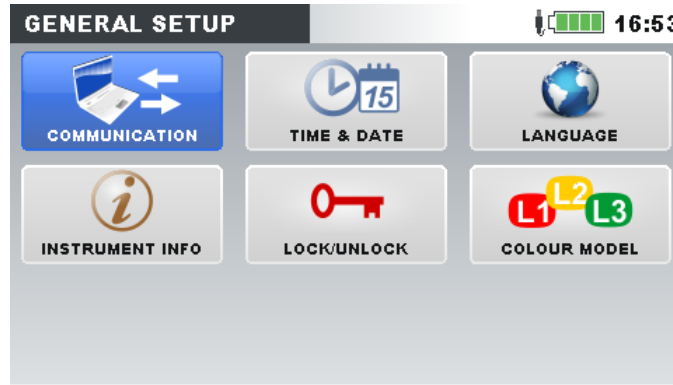

Figure 3.9: General setup submenu

Table 3.5: Keys in submenus

	Selects function within each submenu.
	Enters selected function.
	Returns to the "MAIN MENU".

3.5 U, I, f

Voltage, current and frequency parameters can be observed in the "U, I, f" screens. Measurement results can be viewed in a tabular (METER) or a graphical form (SCOPE, TREND). TREND view is active only in RECORDING mode. See section 3.13 for details.

3.5.1 Meter

By entering U, I, f option, the U, I, f – METER tabular screen is shown (see figures below).

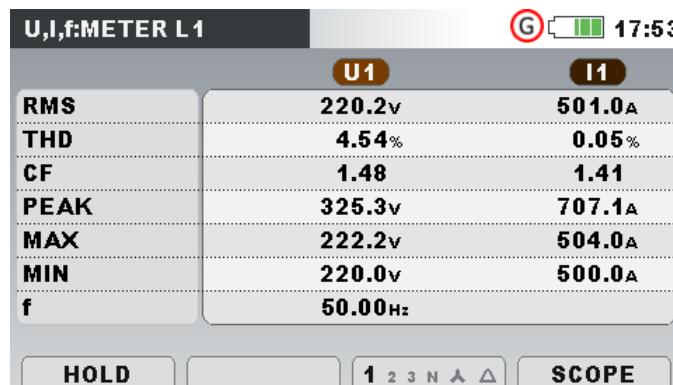

Figure 3.10: U, I, f meter phase table screens (L1, L2, L3, N)

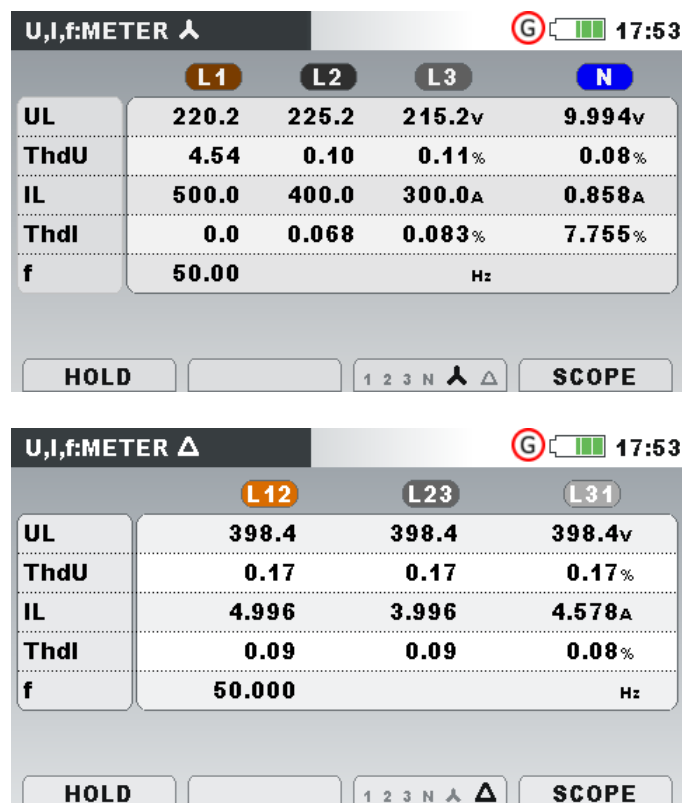

Figure 3.11: U, I, f meter summary table screens

In those screens on-line voltage and current measurements are shown. Descriptions of symbols and abbreviations used in this menu are shown in table below.

Table 3.6: Instrument screen symbols and abbreviations

RMS	
UL	True effective value U_{RMS} and I_{RMS}
IL	
THD	
ThdU	Total harmonic distortion THD_U and THD_I
ThdI	
CF	Crest factor CF_U and CF_I
PEAK	Peak value U_{PK} and I_{PK}
MAX	Maximal $U_{RMS\frac{1}{2}}$ voltage and maximal $I_{RMS\frac{1}{2}}$ current, measured after RESET (key: F2)
MIN	Minimal $U_{RMS\frac{1}{2}}$ voltage and minimal $I_{RMS\frac{1}{2}}$ current, measured after RESET (key: F2)
f	Frequency on reference channel



Note: In case of overloading current or overvoltage on AD converter, icon  will be displayed in the status bar of the instrument.

Table 3.7: Keys in Meter screens

F1	HOLD	Holds measurement on display.
	RUN	Runs held measurement.
F2	RESET	Resets MAX and MIN values ($U_{Rms\frac{1}{2}}$ and $I_{Rms\frac{1}{2}}$).
F3	1 2 3 N ^ Δ	Shows measurements for phase L1.
	1 2 3 N ^ Δ	Shows measurements for phase L2.
	1 2 3 N ^ Δ	Shows measurements for phase L3.
	1 2 3 N ^ Δ	Shows measurements for neutral channel.
	1 2 3 N ^ Δ	Shows measurements for all phases.
	1 2 3 N ^ Δ	Shows measurements for all phase to phase voltages.
	12 23 31 Δ	Shows measurements for phase to phase voltage L12.
	12 23 31 Δ	Shows measurements for phase to phase voltage L23.
	12 23 31 Δ	Shows measurements for phase to phase voltage L31.
	12 23 31 Δ	Shows measurements for all phase to phase voltages.
F4	METER	Switches to METER view.
	SCOPE	Switches to SCOPE view.
	TREND	Switches to TREND view (available only during recording).
		Triggers Waveform snapshot.
ESC		Returns to the “MEASUREMENTS” submenu.

3.5.2 Scope

Various combinations of voltage and current waveforms can be displayed on the instrument, as shown below.

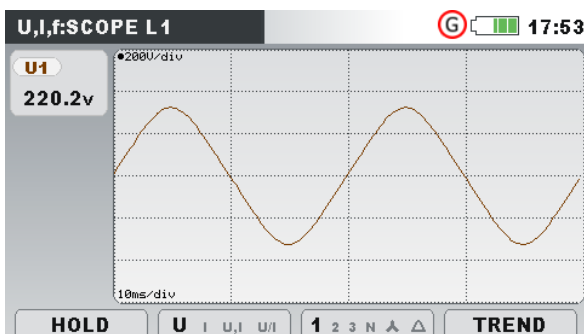

Figure 3.12: Voltage only waveform

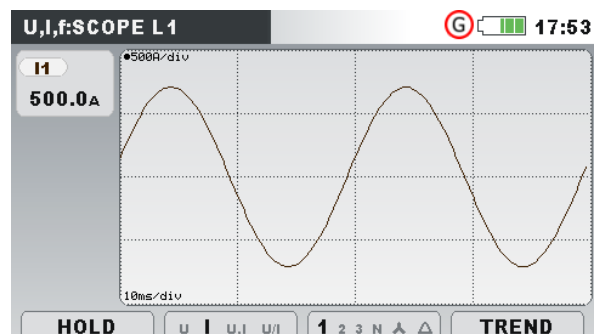

Figure 3.13: Current only waveform

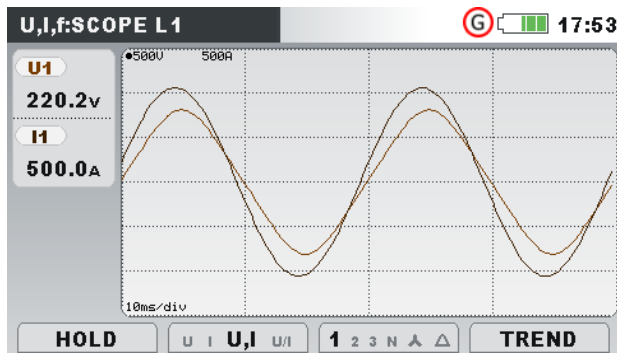

Figure 3.14: Voltage and current waveform (single mode)

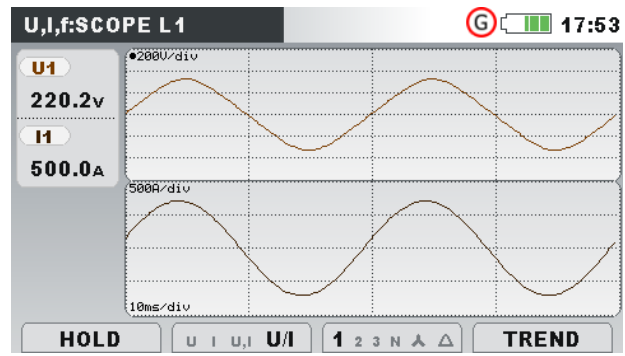





Figure 3.15: Voltage and current waveform (dual mode)

Table 3.8: Instrument screen symbols and abbreviations

U1, U2, U3, Un	True effective value of phase voltage: U ₁ , U ₂ , U ₃ , U _N
U12, U23, U31	True effective value of phase-to-phase (line) voltage: U ₁₂ , U ₂₃ , U ₃
I1, I2, I3, In	True effective value of current: I ₁ , I ₂ , I ₃ , I _N

Table 3.9: Keys in Scope screens

F1	HOLD	Holds measurement on display.
	RUN	Runs held measurement.
F2	U U, I U/I	Selects which waveforms to show: Shows voltage waveform.
	I U, I U/I	Shows current waveform.
	U U, I U/I	Shows voltage and current waveform (single graph).
	U U, I U/I	Shows voltage and current waveform (dual graph).
F3	1 2 3 N ^ Δ	Selects between phase, neutral, all-phases and line view: Shows waveforms for phase L1.
	1 2 3 N ^ Δ	Shows waveforms for phase L2.
	1 2 3 N ^ Δ	Shows waveforms for phase L3.
	1 2 3 N ^ Δ	Shows waveforms for neutral channel.
	1 2 3 N ^ Δ	Shows all phase waveforms.
	1 2 3 N ^ Δ	Shows all phase-to-phase waveforms.
	12 23 31 Δ	Shows waveforms for phase L12.
	12 23 31 Δ	Shows waveforms for phase L23.
	12 23 31 Δ	Shows waveforms for phase L31.
	12 23 31 Δ	Shows all phase waveforms.

METER	Switches to METER view.
F4	SCOPE Switches to SCOPE view.
	TREND Switches to TREND view (available only during recording).
ENTER	Selects which waveform to zoom (only in U/I or U+I).
	Sets vertical zoom.
	Sets horizontal zoom.
	Triggers Waveform snapshot.
ESC	Returns to the "MEASUREMENTS" submenu.

3.5.3 Trend

While GENERAL RECORDER is active, TREND view is available (see section 3.13 for instructions how to start recorder).

Voltage and current trends

Current and voltage trends can be observed by cycling function key F4 (METER-SCOPE-TREND).

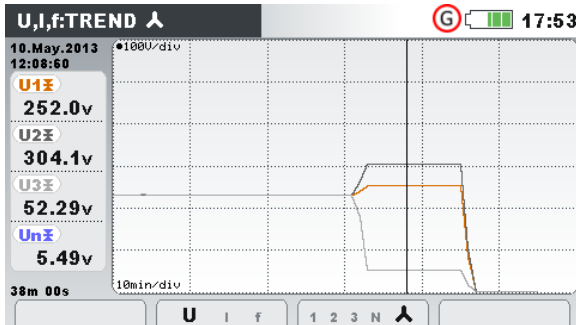

Figure 3.16: Voltage trend (all voltages)

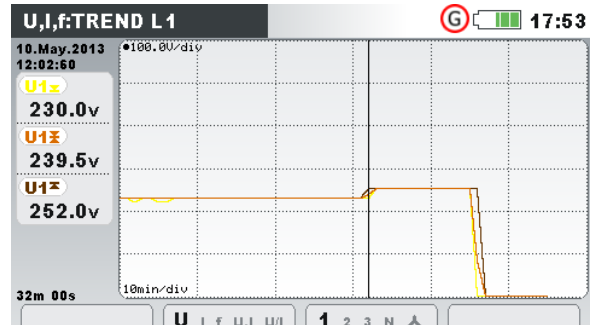

Figure 3.17: Voltage trend (single voltage)

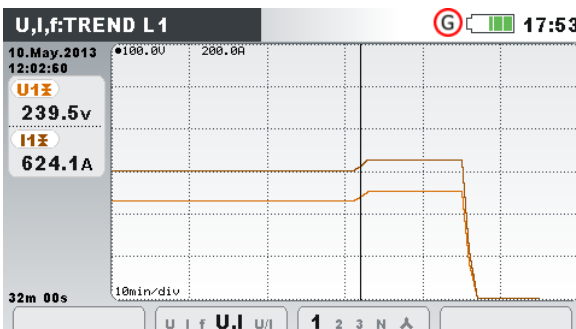

Figure 3.18: Voltage and current trend

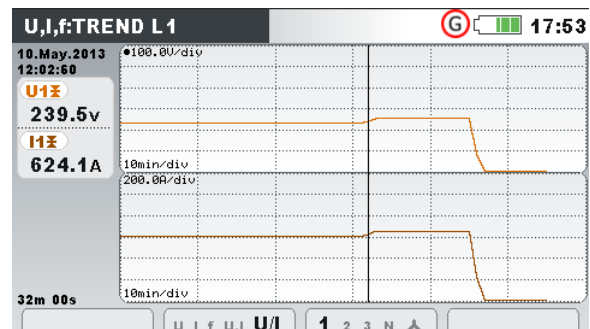

Figure 3.19: Voltage and current trend

(single mode)

(dual mode)

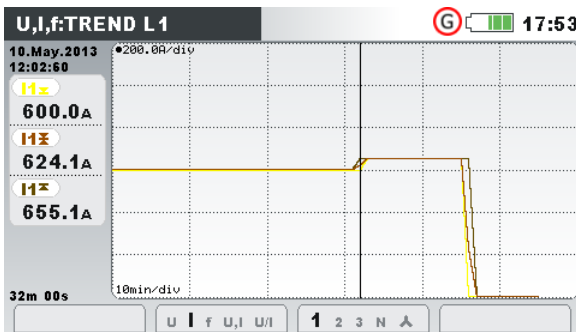

Figure 3.20: Trends of all currents

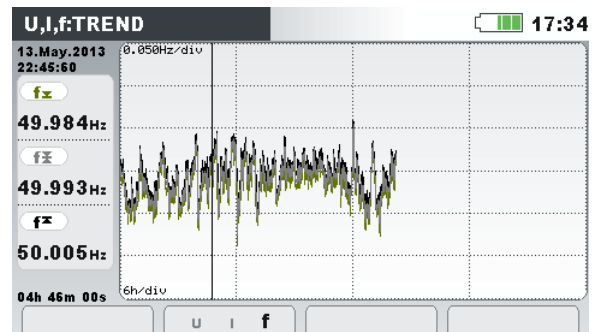

Figure 3.21: Frequency trend

Table 3.10: Instrument screen symbols and abbreviations

U1, U2, U3, Un, U12, U23, U31	Maximal (☒), average (☒) and minimal (☒) value of phase RMS voltage U_1, U_2, U_3, U_N or line voltage U_{12}, U_{23}, U_{31} for time interval (IP) selected by cursor.
I1, I2, I3, In	Maximal (☒), average (☒) and minimal (☒) value of current I_1, I_2, I_{3s}, I_N for time interval (IP) selected by cursor.
f	Maximal (☒), active average (☒) and minimal (☒) value of frequency at synchronization channel for time interval (IP) selected by cursor.
10.May.2013 12:02:00	Timestamp of interval (IP) selected by cursor.
32m 00s	Current GENERAL RECORDER time (d - days, h - hours, m - minutes, s - seconds)

Table 3.11: Keys in Trend screens

F2	U I f U, I U/I	Selects between the following options:
	U I f U, I U/I	Shows voltage trend.
	U I f U, I U/I	Shows current trend.
	U I f U, I U/I	Shows frequency trend.
	U I f U, I U/I	Shows voltage and current trend (single mode).
F3	U I f U, I U/I	Shows voltage and current trend (dual mode).
	1 2 3 N ^	Selects between phases, neutral channel, all-phases view:
	1 2 3 N ^	Shows trend for phase L1.
	1 2 3 N ^	Shows trend for phase L2.
	1 2 3 N ^	Shows trend for phase L3.
	1 2 3 N ^	Shows trend for neutral channel.
1 2 3 N ^	Shows all phases trends.	
1 2 3 1 Δ	Shows trend for phases L12.	

	Shows trend for phases L23.
	Shows trend for phases L31.
	Shows all phase-to-phase trends.
	Switches to METER view.
SCOPE	Switches to SCOPE view.
	Switches to TREND view.
	Moves cursor and selects time interval (IP) for observation.
	Returns to the "MEASUREMENTS" submenu.

3.6 Power

In POWER screens instrument shows measured power parameters. Results can be seen in a tabular (METER) or a graphical form (TREND). TREND view is active only while GENERAL RECORDER is active. See section 3.13 for instructions how to start recorder. In order to fully understand meanings of particular power parameter see sections 5.1.5.

3.6.1 Meter

By entering POWER option from Measurements submenu the tabular POWER (METER) screen is shown (see figure below).

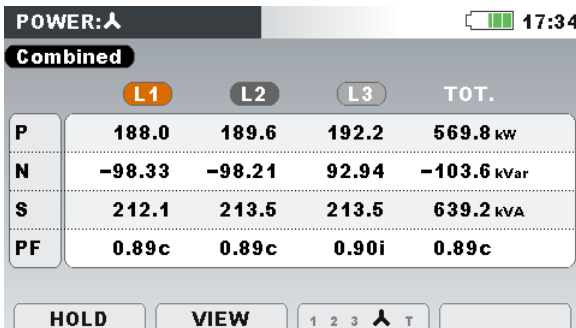

Figure 3.22: Power measurements summary (combined)

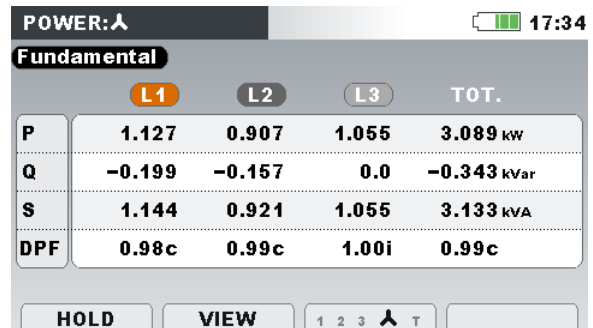

Figure 3.23: Power measurements summary (fundamental)

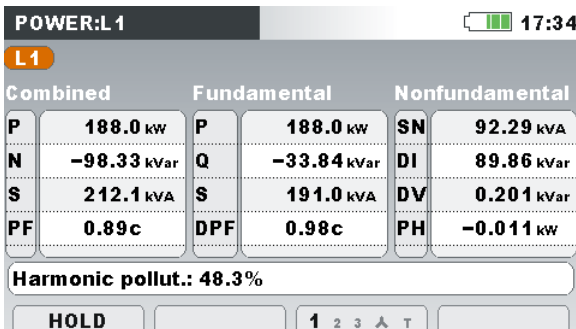

Figure 3.24: Detailed power measurements at phase L1

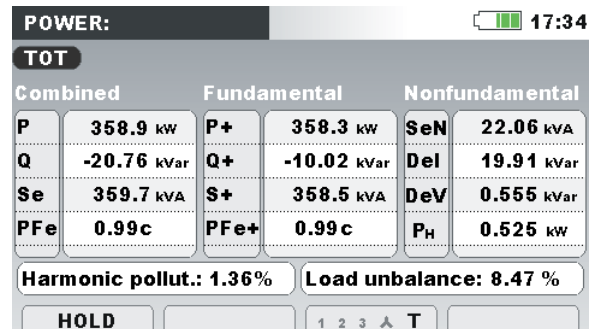



Figure 3.25: Detailed total power measurements

Description of symbols and abbreviations used in POWER (METER) screens are shown in table below.

Table 3.12: Instrument screen symbols and abbreviations

P	Depending on the screen position: In Combined column: Instantaneous combined (fundamental and nonfundamental) active power ($\pm P_1, \pm P_2, \pm P_3, \pm P_{tot}$) In Fundamental column: Instantaneous fundamental active power ($\pm P_{fund1}, \pm P_{fund2}, \pm P_{fund3}$)
N	Instantaneous combined (fundamental and nonfundamental) nonactive power ($\pm N_1, \pm N_2, \pm N_3, \pm N_{tot}$)
Q	Instantaneous fundamental reactive power ($\pm Q_{fund1}, \pm Q_{fund2}, \pm Q_{fund3}, \pm Q^+_{fundtot}$)
S	Depending on the screen position: In Combined column: Instantaneous combined (fundamental and nonfundamental) apparent power (S_1, S_2, S_3) In Fundamental column: Instantaneous fundamental active power ($S_{fund1}, S_{fund2}, S_{fund3}$)
P+	Positive sequence of total active fundamental power ($\pm P^+_{tot}$)
Q+	Positive sequence of total reactive fundamental power ($\pm Q^+_{tot}$)
S+	Positive sequence of total apparent fundamental power ($\pm S^+_{tot}$)
PF+	Positive sequence power factor (fundamental, total)
Se	Combined (fundamental and nonfundamental) total effective apparent power (Se_{tot})
SN	Phase nonfundamental apparent power (SN_1, SN_2, SN_3)
Sen	Total effective nonfundamental apparent power (Sen_{tot})
DI	Phase current distortion power (DI_1, DI_2, DI_3)
DeI	Total effective current distortion power (DeI_{tot})
Dv	Phase voltage distortion power (Dv_1, Dv_2, Dv_3)
Dev	Total effective voltage distortion power (Dev_{tot})
PH	Phase and total harmonic active power ($P_{H1}^+, P_{H2}^+, P_{H3}^+, \pm P_{Htot}$)
PF	Instantaneous phase combined (fundamental and nonfundamental) power factor ($\pm PF_1, \pm PF_2, \pm PF_3$)
PF _e	Instantaneous total effective combined (fundamental and nonfundamental) power factor ($\pm PF_e$)
DPF	Instantaneous phase fundamental power factor ($\pm DPF_1, \pm DPF_2, \pm DPF_3$)
Harmonic Pollution	Harmonic pollution according to the standard IEEE 1459
Load unbalance	Load unbalance according to the standard IEEE 1459

Table 3.13: Keys in Power (METER) screens

F1	HOLD	Holds measurement on display.
	RUN	Runs held measurement.
F2	VIEW	Switches between Combined, Fundamental and Nonfundamental view.
	1 2 3 ^ T	Shows measurements for phase L1.
F3	1 2 3 ^ T	Shows measurements for phase L2.
	1 2 3 ^ T	Shows measurements for phase L3.
	1 2 3 ^ T	Shows brief view on measurements on all phases in a single screen.
	1 2 3 ^ T	Shows measurement results for TOTAL power measurements.
	METER	Switches to METER view.
F4	TREND	Switches to TREND view (available only during recording).
		Triggers Waveform snapshot.
ESC		Returns to the "MEASUREMENTS" submenu.

3.6.2 Trend

During active recording TREND view is available (see section 3.13 for instructions how to start GENERAL RECORDER).

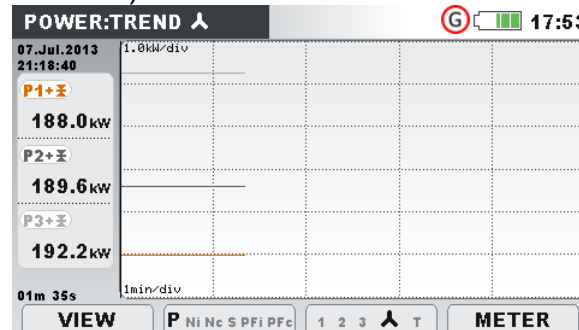

Figure 3.26: Power trend screen

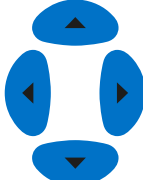

Table 3.14: Instrument screen symbols and abbreviations

P1±, P2±, P3±, P±	View: Combined power Maximal (⌘), average (⌘) and minimal (⌘) value of consumed (P_1^+ , P_2^+ , P_3^+ , P_{tot}^+) or generated (P_1^- , P_2^- , P_3^- , P_{tot}^-) active combined power for time interval (IP) selected by cursor.
P1±, P2±, P3±, P±±	View: Fundamental power Maximal (⌘), average (⌘) and minimal (⌘) value of consumed (P_{fund1}^+ , P_{fund2}^+ , P_{fund3}^+ , P_{+tot}^+) or generated (P_{fund1}^- , P_{fund2}^- , P_{fund3}^- , P_{+tot}^-) active fundamental power for time interval (IP) selected by cursor.

Ni1±, Ni2±, Ni3±, Nit±	Maximal (⚡), average (⚡) and minimal (⚡) value of consumed (N_{1ind}^+ , N_{2ind}^+ , N_{3ind}^+ , N_{totind}^+) or generated (N_{1ind}^- , N_{2ind}^- , N_{3ind}^- , N_{totind}^-) inductive combined nonactive power for time interval (IP) selected by cursor.
Nc1±, Nc2±, Nc3±, Nct±	Maximal (⚡), average (⚡) and minimal (⚡) value of consumed (N_{1cap}^+ , N_{2cap}^+ , N_{3cap}^+ , N_{totcap}^+) or generated (N_{1cap}^- , N_{2cap}^- , N_{3cap}^- , N_{totcap}^-) capacitive combined nonactive power for time interval (IP) selected by cursor.
S1, S2, S3, Se	View: Combined power Maximal (⚡), average (⚡) and minimal (⚡) value of combined apparent power (S_1 , S_2 , S_3 , $S_{e_{tot}}$) for time interval (IP) selected by cursor.
S1, S2, S3, S+	View: Fundamental power Maximal (⚡), average (⚡) and minimal (⚡) value of combined apparent power (S_{fund1} , S_{fund2} , S_{fund3} , S_{tot}^+) for time interval (IP) selected by cursor.
PFi1±, PFi2±, PFi3±, PFit±	Maximal (⚡), average (⚡) and minimal (⚡) value of inductive power factor (1 st quadrant: PF_{1ind}^+ , PF_{2ind}^+ , PF_{3ind}^+ , PF_{totind}^+ and 3 rd quadrant: PF_{1ind}^- , PF_{2ind}^- , PF_{3ind}^- , PF_{totind}^-) for time interval (IP) selected by cursor.
PFc1±, PFc2±, PFc3±, PFct±	Maximal (⚡), average (⚡) and minimal (⚡) value of capacitive power factor (4 th quadrant: PF_{1cap}^+ , PF_{2cap}^+ , PF_{3cap}^+ , PF_{totcap}^+ and 2 nd quadrant: PF_{1cap}^- , PF_{2cap}^- , PF_{3cap}^- , PF_{totcap}^-) for time interval (IP) selected by cursor.
Qi1±, Qi2±, Qi3±, Q+i±	Maximal (⚡), average (⚡) and minimal (⚡) value of consumed (Q_{1ind}^+ , Q_{2ind}^+ , Q_{3ind}^+ , Q_{totind}^+) or generated (Q_{1ind}^- , Q_{2ind}^- , Q_{3ind}^- , Q_{totind}^-) fundamental reactive inductive power for time interval (IP) selected by cursor.
Qc1±, Qc2±, Qc3±, Q+c±	Maximal (⚡), average (⚡) and minimal (⚡) value of consumed (Q_{1cap}^+ , Q_{2cap}^+ , Q_{3cap}^+ , Q_{captot}^+) or generated (Q_{1cap}^- , Q_{2cap}^- , Q_{3cap}^- , Q_{captot}^-) fundamental reactive capacitive power for time interval (IP) selected by cursor.
DPFi1±, DPFi2±, DPFi3± DPF+i±	Maximal (⚡), average (⚡) and minimal (⚡) value of inductive displacement power factor (1 st quadrant: DPF_{1ind}^+ , DPF_{2ind}^+ , DPF_{3ind}^+ , DPF_{totind}^+ , and 3 rd quadrant: DPF_{1ind}^- , DPF_{2ind}^- , DPF_{3ind}^- , DPF_{totind}^-) for time interval (IP) selected by cursor.
DPFc1±, DPFc2±, DPFc3± DPF+c±	Maximal (⚡), average (⚡) and minimal (⚡) value of capacitive displacement power factor (4 th quadrant: DPF_{1cap}^+ , DPF_{2cap}^+ , DPF_{3cap}^+ , DPF_{totcap}^+ , and 2 nd quadrant: DPF_{1cap}^- , DPF_{2cap}^- , DPF_{3cap}^- , DPF_{totcap}^-) for time interval (IP) selected by cursor.
Sn1, Sn2, Sn3, Sen	Maximal (⚡), average (⚡) and minimal (⚡) value of consumed or generated nonfundamental apparent power (SN_1 , SN_2 , SN_3 , Sen_{tot}) for time interval (IP) selected by cursor.
Di1, Di2, Di3, Dei	Maximal (⚡), average (⚡) and minimal (⚡) value of consumed or generated phase current distortion power (DI_1 , DI_2 , DI_3 , Dei_{tot}) for time interval (IP) selected by cursor.
Dv1, Dv2, Dv3, Dev	Maximal (⚡), average (⚡) and minimal (⚡) value of consumed or generated phase voltage distortion power (DV_1 , DV_2 , DV_3 , Dev_{tot}) for time interval (IP) selected by cursor.

Ph1±, Ph2±, Ph3±, Pht± Maximal (▲), average (⌘) and minimal (▼) value of consumed ($P_{H1}^+, P_{H2}^+, P_{H3}^+, P_{Htot}^+$) or generated ($P_{H1}^-, P_{H2}^-, P_{H3}^-, P_{Htot}^-$) active harmonic power for time interval (IP) selected by cursor.

Table 3.15: Keys in Power (TREND) screens

		<p>Selects which measurement should instrument represent on graph:</p> <ul style="list-style-type: none"> - Consumed or Generated Measurements related to consumed (suffix: +) or generated power (suffix: -). - Combined, Fundamental or Nonfundamental Measurement related to fundamental power, nonfundamental power or combined. 																												
F1	VIEW	<p>Keys in VIEW window:</p> <hr/> <div style="display: flex; align-items: center;">  <div style="margin-left: 20px;">Selects option.</div> </div> <hr/> <div style="display: flex; align-items: center;">  <div style="margin-left: 20px;">Confirms selected option.</div> </div> <hr/> <div style="display: flex; align-items: center;">  <div style="margin-left: 20px;">Exits selection window without change.</div> </div> <hr/> <p>If Combined power is selected:</p> <table border="0"> <tr> <td>P Ni Nc S PFi Pfc</td> <td>Shows combined active power trend.</td> </tr> <tr> <td>P Ni Nc S PFi Pfc</td> <td>Shows combined inductive nonactive power trend.</td> </tr> <tr> <td>P Ni Nc S PFi Pfc</td> <td>Shows combined capacitive nonactive power trend.</td> </tr> <tr> <td>P Ni Nc S PFi Pfc</td> <td>Shows combined apparent power trend.</td> </tr> <tr> <td>P Ni Nc S PFi Pfc</td> <td>Shows inductive power factor trend.</td> </tr> <tr> <td>P Ni Nc S Pfi PFC</td> <td>Shows capacitive power factor trend.</td> </tr> </table> <hr/> <p>If Fundamental power is selected:</p> <table border="0"> <tr> <td>P Qi Qc S DPFi DPfc</td> <td>Shows fundamental active power trend.</td> </tr> <tr> <td>P Qi Qc S DPFi DPfc</td> <td>Shows fundamental inductive reactive power trend.</td> </tr> <tr> <td>P Qi Qc S DPFi DPfc</td> <td>Shows fundamental capacitive reactive power trend.</td> </tr> <tr> <td>P Qi Qc S DPFi DPfc</td> <td>Shows fundamental apparent power trend.</td> </tr> <tr> <td>P Qi Qc S DPFi DPfc</td> <td>Shows inductive displacement power factor trend.</td> </tr> <tr> <td>P Qi Qc S DPfi DPFC</td> <td>Shows capacitive displacement power factor trend.</td> </tr> </table> <hr/> <p>If Nonfundamental power is selected:</p> <table border="0"> <tr> <td>Sn Di Dv Ph</td> <td>Shows nonfundamental apparent power trend.</td> </tr> <tr> <td>Sn Di Dv Ph</td> <td>Shows nonfundamental current distortion power.</td> </tr> </table>	P Ni Nc S PFi Pfc	Shows combined active power trend.	P Ni Nc S PFi Pfc	Shows combined inductive nonactive power trend.	P Ni Nc S PFi Pfc	Shows combined capacitive nonactive power trend.	P Ni Nc S PFi Pfc	Shows combined apparent power trend.	P Ni Nc S PFi Pfc	Shows inductive power factor trend.	P Ni Nc S Pfi PFC	Shows capacitive power factor trend.	P Qi Qc S DPFi DPfc	Shows fundamental active power trend.	P Qi Qc S DPFi DPfc	Shows fundamental inductive reactive power trend.	P Qi Qc S DPFi DPfc	Shows fundamental capacitive reactive power trend.	P Qi Qc S DPFi DPfc	Shows fundamental apparent power trend.	P Qi Qc S DPFi DPfc	Shows inductive displacement power factor trend.	P Qi Qc S DPfi DPFC	Shows capacitive displacement power factor trend.	Sn Di Dv Ph	Shows nonfundamental apparent power trend.	Sn Di Dv Ph	Shows nonfundamental current distortion power.
P Ni Nc S PFi Pfc	Shows combined active power trend.																													
P Ni Nc S PFi Pfc	Shows combined inductive nonactive power trend.																													
P Ni Nc S PFi Pfc	Shows combined capacitive nonactive power trend.																													
P Ni Nc S PFi Pfc	Shows combined apparent power trend.																													
P Ni Nc S PFi Pfc	Shows inductive power factor trend.																													
P Ni Nc S Pfi PFC	Shows capacitive power factor trend.																													
P Qi Qc S DPFi DPfc	Shows fundamental active power trend.																													
P Qi Qc S DPFi DPfc	Shows fundamental inductive reactive power trend.																													
P Qi Qc S DPFi DPfc	Shows fundamental capacitive reactive power trend.																													
P Qi Qc S DPFi DPfc	Shows fundamental apparent power trend.																													
P Qi Qc S DPFi DPfc	Shows inductive displacement power factor trend.																													
P Qi Qc S DPfi DPFC	Shows capacitive displacement power factor trend.																													
Sn Di Dv Ph	Shows nonfundamental apparent power trend.																													
Sn Di Dv Ph	Shows nonfundamental current distortion power.																													

	Sn Di DV Ph	Shows nonfundamental voltage distortion power.
	Sn Di Dv Ph	Shows nonfundamental active power.
		Selects between phase, all-phases and Total power view:
	1 2 3 ^ T	Shows power parameters for phase L1.
	1 2 3 ^ T	Shows power parameters for phase L2.
	1 2 3 ^ T	Shows power parameters for phase L3.
	1 2 3 ^ T	Shows power parameters for phases L1, L2 and L3 on the same graph.
	1 2 3 ^ T	Shows Total power parameters.
	METER	Switches to METER view.
	TREND	Switches to TREND view (available only during recording).
		Moves cursor and selects time interval (IP) for observation.
		Returns to the "MEASUREMENTS" submenu.

3.7 Energy

3.7.1 Meter

Instrument shows status of energy counters in energy menu. Results can be seen in a tabular (METER) form. Energy measurement is active only if GENERAL RECORDER is active. See section 3.13 for instructions how to start GENERAL RECORDER. The meter screens are shown on figures below.

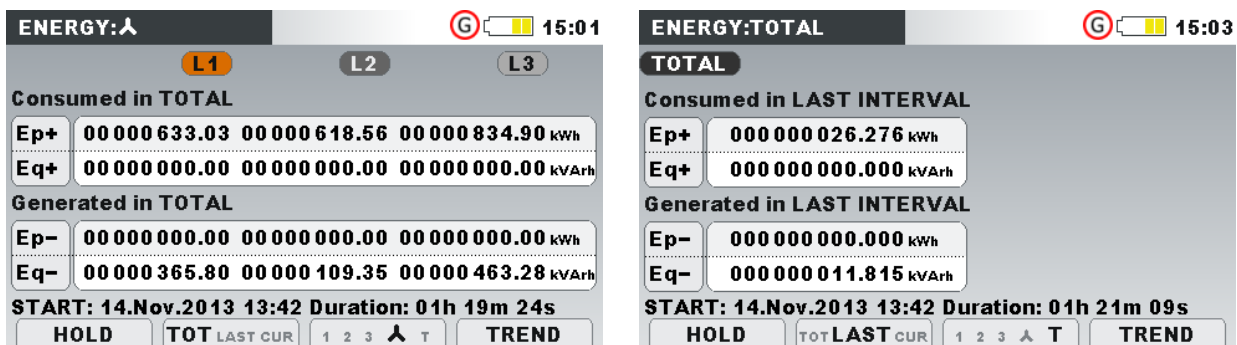



Figure 3.27: Energy counters screen

Table 3.16: Instrument screen symbols and abbreviations

Ep+	Consumed (+) phase (Ep ₁ ⁺ , Ep ₂ ⁺ , Ep ₃ ⁺) or total (Ep _{tot} ⁺) active energy
Ep-	Generated (-) phase (Ep ₁ ⁻ , Ep ₂ ⁻ , Ep ₃ ⁻) or total (Ep _{tot} ⁻) active energy
Eq+	Consumed (+) phase (Eq ₁ ⁺ , Eq ₂ ⁺ , Eq ₃ ⁺) or total (Eq _{tot} ⁺) fundamental reactive energy
Eq-	Generated (-) phase (Eq ₁ ⁻ , Eq ₂ ⁻ , Eq ₃ ⁻) or total (Eq _{tot} ⁻) fundamental reactive energy

Start	Recorder start time and date
Duration	Recorder elapsed time

Table 3.17: Keys in Energy (METER) screens

F1	HOLD	Holds measurement on display.
	RUN	Runs held measurement.
F2	TOT LAST CUR	Shows energy registers for whole record.
	TOT LAST CUR	Shows energy registers for last interval.
	TOT LAST CUR	Shows energy registers for current interval.
F3	1 2 3 ^ T	Shows energy parameters for phase L1.
	1 2 3 ^ T	Shows energy parameters for phase L2.
	1 2 3 ^ T	Shows energy parameters for phase L3.
	1 2 3 ^ T	Shows all phases energy.
	1 2 3 ^ T	Shows energy parameters for Totals.
F4	METER	Switches to METER view.
	TREND	Switches to TREND view.
		Triggers Waveform snapshot.
	ESC	Returns to the "MEASUREMENTS" submenu.

3.7.2 Trend

TREND view is available only during active recording (see section 3.13 for instructions how to start GENERAL RECORDER).

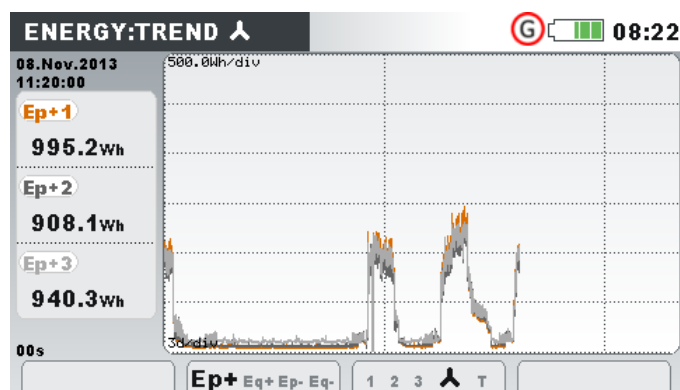

Figure 3.28: Energy trend screen

Table 3.18: Instrument screen symbols and abbreviations

Ep+	Consumed (+) phase (Ep_1^+ , Ep_2^+ , Ep_3^+) or total (Ep_{tot}^+) active energy
Ep-	Generated (-) phase (Ep_1^- , Ep_2^- , Ep_3^-) or total (Ep_{tot}^-) active energy
Eq+	Consumed (+) phase (Eq_1^+ , Eq_2^+ , Eq_3^+) or total (Eq_{tot}^+) fundamental reactive energy
Eq-	Generated (-) phase (Eq_1^- , Eq_2^- , Eq_3^-) or total (Eq_{tot}^-) fundamental reactive energy

Start	Recorder start time and date
Duration	Recorder elapsed time

Table 3.19: Keys in Energy (TREND) screens

F2	Ep+ Eq+ Ep- Eq-	Shows active consumed energy for time interval (IP) selected by cursor.
	Ep+ Eq+ Ep- Eq-	Shows reactive consumed energy for time interval (IP) selected by cursor.
	Ep+ Eq+ Ep- Eq-	Shows active generated energy for time interval (IP) selected by cursor.
	Ep+ Eq+ Ep- Eq-	Shows reactive generated energy for time interval (IP) selected by cursor.
F3	1 2 3 ▲ T	Shows energy records for phase L1.
	1 2 3 ▲ T	Shows energy records for phase L2.
	1 2 3 ▲ T	Shows energy records for phase L3.
	1 2 3 ▲ T	Shows all phases energy records.
	1 2 3 ▲ T	Shows energy records for Totals.
F4	METER	Switches to METER view.
	TREND	Switches to TREND view.
ESC		Returns to the "MEASUREMENTS" submenu.

3.8 Harmonics / interharmonics

Harmonics presents voltage and current signals as a sum of sinusoids of power frequency and its integer multiples. Sinusoidal wave with frequency k-times higher than fundamental (k is an integer) is called harmonic wave and is denoted with amplitude and a phase shift (phase angle) to a fundamental frequency signal. If a signal decomposition with Fourier transformation results with presence of a frequency that is not integer multiple of fundamental, this frequency is called interharmonic frequency and component with such frequency is called interharmonic. See 5.1.7 for details.

3.8.1 Meter

By entering HARMONICS option from Measurements submenu the tabular HARMONICS (METER) screen is shown (*see figure below*). In this screens voltage and current harmonics or interharmonics and THD are shown.

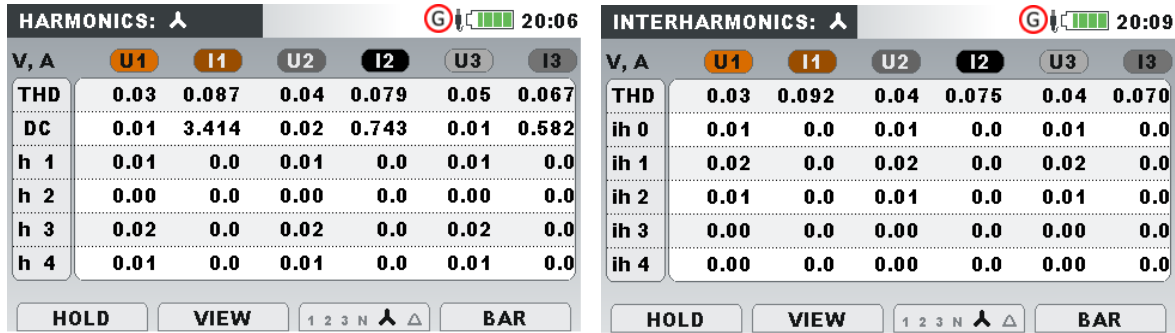

Figure 3.29: Harmonics and interharmonics (METER) screens

Description of symbols and abbreviations used in METER screens are shown in table below.

Table 3.20: Instrument screen symbols and abbreviations

THD	Total voltage / current harmonic distortion THD _U and THD _I in % of fundamental voltage / current harmonic or in RMS V, A.
DC	Voltage or current DC component in % of fundamental voltage / current harmonic or in RMS V, A.
h1 ... h50	n-th harmonic voltage U _{h_n} or current I _{h_n} component in % of fundamental voltage / current harmonic or in RMS V, A.
ih0 ... ih50	n-th interharmonic voltage U _{ih_n} or current I _{ih_n} component in % of fundamental voltage / current harmonic or in RMS V, A.

Table 3.21: Keys in Harmonics / interharmonics (METER) screens

	HOLD	Holds measurement on display.	
	RUN	Runs held measurement.	
Switches view between Harmonics and Interharmonics. Switches units between:			
<ul style="list-style-type: none"> - RMS (Volts ,Amperes) - % of fundamental harmonic 			
Keys in VIEW window:			
	VIEW		Selects option.
			Confirms selected option.
			Exits selection window without change.
		Selects between single phase, neutral, all-phases and line harmonics / interharmonics view.	
	1 2 3 N ^ Δ	Shows harmonics / interharmonics components for phase L1.	

	Shows harmonics / interharmonics components for phase L2.
	Shows harmonics / interharmonics components for phase L3.
	Shows harmonics / interharmonics components for neutral channel.
	Shows harmonics / interharmonics components for all phases on single screen.
	Shows harmonics / interharmonics components for phase-to-phase voltages.
	Shows harmonics / interharmonics components for phases L12.
	Shows harmonics / interharmonics components for phases L23.
	Shows harmonics / interharmonics components for phases L31.
	Shows harmonics / interharmonics components for phase-to-phase voltages.
	Switches to METER view.
	Switches to BAR view.
	Switches to TREND view (available only during recording).
	Shifts through harmonic / interharmonic components.
	Triggers Waveform snapshot.
	Returns to the “MEASUREMENTS” submenu.

3.8.2 Histogram (Bar)

Bar screen displays dual bar graphs. The upper bar graph shows voltage harmonics and the lower bar graph shows current harmonics.

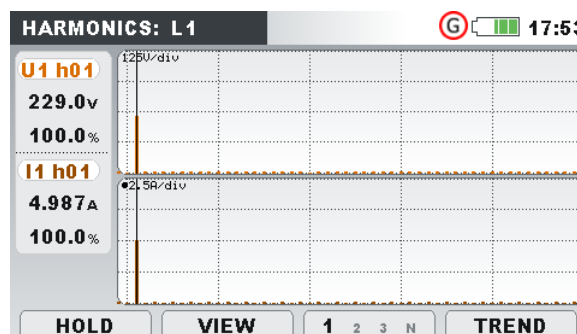











Figure 3.30: Harmonics histogram screen





Description of symbols and abbreviations used in BAR screens are shown in table below.

Table 3.22: Instrument screen symbols and abbreviations

Ux h01 ... h50	Voltage harmonic / interharmonic component in V_{RMS} and in % of fundamental voltage
Ix h01 ... h50	Current harmonic / interharmonic component in A_{RMS} and in % of fundamental current
Ux DC	DC voltage in V and in % of fundamental voltage
Ix DC	DC current in A and in % of fundamental current
Ux THD	Total voltage harmonic distortion THD_U in V and in % of fundamental voltage
Ix THD	Total current harmonic distortion THD_I in A_{RMS} and in % of fundamental current

Table 3.23: Keys in Harmonics / interharmonics (BAR) screens

	HOLD	Holds measurement on display.	
	RUN	Runs held measurement.	
Switches view between harmonics and interharmonics.			
Keys in VIEW window:			
	VIEW	 	Selects option.
			Confirms selected option.
			Exits selection window without change.
	Selects between single phases and neutral channel harmonics / interharmonics bars.		
	1 2 3 N	Shows harmonics / interharmonics components for phase L1.	
	1 2 3 N	Shows harmonics / interharmonics components for phase L2.	
	1 2 3 N	Shows harmonics / interharmonics components for phase L3.	
	1 2 3 N	Shows harmonics / interharmonics components for neutral channel.	
	12 23 31	Shows harmonics / interharmonics components for phase L12.	
	12 23 31	Shows harmonics / interharmonics components for phases L23.	
	12 23 31	Shows harmonics / interharmonics components for phases L31.	
	METER	Switches to METER view.	
	BAR	Switches to BAR view.	
	TREND	Switches to TREND view (available only during recording).	
	Scales displayed histogram by amplitude.		

	
	Scrolls cursor to select single harmonic / interharmonic bar.
	Toggles cursor between voltage and current histogram.
	Triggers Waveform snapshot.
	Returns to the “MEASUREMENTS” submenu.

3.8.3 Trend

During active GENERAL RECORDER, TREND view is available (see section 3.13 for instructions how to start GENERAL RECORDER). Voltage and current harmonic / interharmonic components can be observed by cycling function key F4 (METER-BAR-TREND).

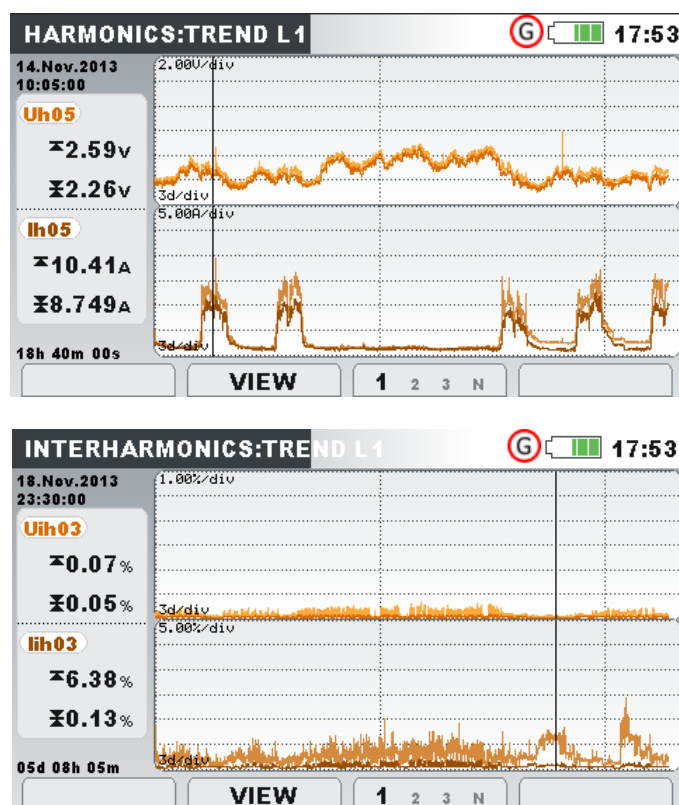

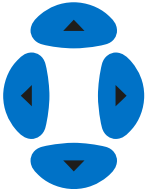

Figure 3.31: Harmonics and interharmonics trend screen

Table 3.24: Instrument screen symbols and abbreviations

thdU	Maximal (≈) and average (≅) value of total voltage harmonic distortion THD _U for selected phase
thdI	Maximal (≈) and average (≅) value of total current harmonic distortion THD _I for selected phase
Udc	Maximal (≈) and average (≅) value of DC voltage component for selected phase
Idc	Maximal (≈) and average (≅) value of selected DC current component

	for selected phase
Uh/Uih	Maximal (M) and average (A) value for selected n-th voltage harmonic / interharmonic component for selected phase
Ih/lih	Maximal (M) and average (A) value of selected n-th current harmonic / interharmonic component for selected phase

Table 3.25: Keys in Harmonics / interharmonics (TREND) screens

		<p>Switches between harmonics or interharmonics view.</p> <p>Switches measurement units between RMS V,A or % of fundamental harmonic.</p> <p>Selects harmonic number for observing.</p>
		<p>Keys in VIEW window:</p>
F2	VIEW	 <p>Selects option.</p>
		 <p>Confirms selected option.</p>
		 <p>Exits selection window without change.</p>
		<p>Selects between single phases and neutral channel harmonics / interharmonics trends.</p>
	1 2 3 N	Shows selected harmonics / interharmonics components for phase L1.
	1 2 3 N	Shows selected harmonics / interharmonics components for phase L2.
F3	1 2 3 N	Shows selected harmonics / interharmonics components for phase L3.
	1 2 3 N	Shows selected harmonics / interharmonics components for neutral channel.
	12 23 31	Shows selected harmonics / interharmonics components for phases L12.
	12 23 31	Shows selected harmonics / interharmonics components for phases L23.
	12 23 31	Shows selected harmonics / interharmonics components for phases L31.
	METER	Switches to METER view.
F4	BAR	Switches to BAR view.
	TREND	Switches to TREND view (available only during recording).



Moves cursor and select time interval (IP) for observation.



Returns to the “MEASUREMENTS” submenu.

3.9 Flickers

Flickers measure the human perception of the effect of amplitude modulation on the mains voltage powering a light bulb. In Flickers menu instrument shows measured flicker parameters. Results can be seen in a tabular (METER) or a graphical form (TREND) - which is active only while GENERAL RECORDER is active. See section 3.13 for instructions how to start recording. In order to understand meanings of particular parameter see section 5.1.8.

3.9.1 Meter

By entering FLICKERS option from MEASUREMENTS submenu the FLICKERS tabular screen is shown (see figure below).

	L1	L2	L3
Urms	229.0	230.5	230.5 v
Pinst,max	1.04	0.34	0.94
Pst(1min)	1.02	0.54	0.97
Pst	1.07	0.25	0.90
Plt	0.78	1.21	0.60

Buttons: HOLD, TREND

Figure 3.32: Flickers table screen

Description of symbols and abbreviations used in METER screen is shown in table below. Note that Flickers measurement intervals are synchronised to real time clock, and therefore refreshed on minute, 10 minutes and 2 hours intervals.

Table 3.26: Instrument screen symbols and abbreviations

Urms	True effective value $U_1, U_2, U_3, U_{12}, U_{23}, U_{31}$
Pinst,max	Maximal instantaneous flicker for each phase refreshed each 10 seconds
Pst(1min)	Short term (1 min) flicker P_{st1min} for each phase measured in last minute
Pst	Short term (10 min) flicker P_{st} for each phase measured in last 10 minutes
Plt	Long term flicker (2h) P_{st} for each phase measured in last 2 hours

Table 3.27: Keys in Flickers (METER) screen

	HOLD	Holds measurement on display.
	RUN	Runs held measurement.



Triggers Waveform snapshot.



Returns to the “MEASUREMENTS” submenu.

3.9.2 Trend

During active recording TREND view is available (see section 3.13 for instructions how to start recording). Flicker parameters can be observed by cycling function key F4 (METER -TREND). Note that Flicker meter recording intervals are determinate by standard IEC 61000-4-15. Flicker meter therefore works independently from chosen recording interval in GENERAL RECORDER.

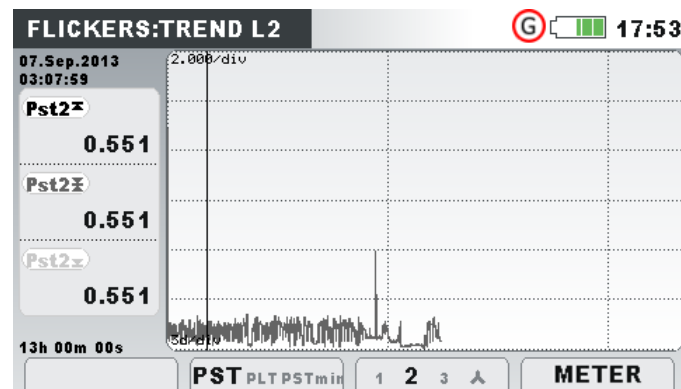







Figure 3.33: Flickers trend screen

Table 3.28: Instrument screen symbols and abbreviations

Pst1m1, Pst1m2, Pst1m3, Pst1m12, Pst1m23, Pst1m31	Maximal (▲), average (⊠) and minimal (▼) value of 1-minute short term flicker $P_{st(1min)}$ for phase voltages U_1, U_2, U_3 or line voltages U_{12}, U_{23}, U_{31}
Pst1, Pst2, Pst3, Pst12, Pst23, Pst31	Maximal (▲), average (⊠) and minimal (▼) value of 10-minutes short term flicker P_{st} for phase voltages U_1, U_2, U_3 or line voltages U_{12}, U_{23}, U_{31}
Plt1, Plt2, Plt3, Plt12, Plt23, Plt31	Maximal (▲), average (⊠) and minimal (▼) value of 2-hours long term flicker P_{lt} in phase voltages U_1, U_2, U_3 or line voltages U_{12}, U_{23}, U_{31}

Table 3.29: Keys in Flickers (TREND) screens

	Pst Plt Pstmin	Selects between the following options:
	Pst Plt Pstmin	Shows 10 min short term flicker P_{st} .
	Pst Plt Pstmin	Shows long term flicker P_{lt} .
	1 2 3 ▲	Shows 1 min short term flicker $P_{st(1min)}$.
	1 2 3 ▲	Selects between trending various parameters:
	1 2 3 ▲	Shows selected flicker trends for phase L1.
	1 2 3 ▲	Shows selected flicker trends for phase L2.
	1 2 3 ▲ ▲	Shows selected flicker trends for phase L3.
	1 2 3 ▲ ▲	Shows selected flicker trends for all phases (average only).
	12 23 31 Δ	Shows selected flicker trends for all phases (average only).
	12 23 31 Δ	Shows selected flicker trends for phases L12.
12 23 31 Δ	Shows selected flicker trends for phases L23.	
12 23 31 Δ	Shows selected flicker trends for phases L31.	
12 23 31 Δ Δ	Shows selected flicker trends for all phases (average only).	
	METER	Switches to METER view.
	TREND	Switches to TREND view (available only during recording).
		Moves cursor and selects time interval (IP) for observation.
		Returns to the "MEASUREMENTS" submenu.

3.10 Phase Diagram

Phase diagram graphically represent fundamental voltages, currents and phase angles of the network. This view is strongly recommended for checking instrument connection before measurement. Note that most measurement issues arise from wrongly connected instrument (see 4.1 for recommended measuring practice). On phase diagram screens instrument shows:

- Graphical presentation of voltage and current phase vectors of the measured system,
- Unbalance of the measured system.

3.10.1 Phase diagram

By entering PHASE DIAGRAM option from MEASUREMENTS submenu, the following screen is shown (see figure below).

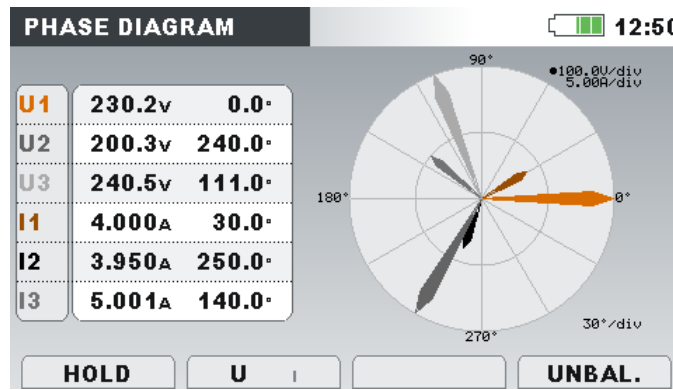

Figure 3.34: Phase diagram screen

Table 3.30: Instrument screen symbols and abbreviations

U1, U2, U3	Fundamental voltages U_{fund_1} , U_{fund_2} , U_{fund_3} with relative phase angle to U_{fund_1}
U12, U23, U31	Fundamental voltages $U_{fund_{12}}$, $U_{fund_{23}}$, $U_{fund_{31}}$ with relative phase angle to $U_{fund_{12}}$
I1, I2, I3	Fundamental currents I_{fund_1} , I_{fund_2} , I_{fund_3} with relative phase angle to U_{fund_1} or $U_{fund_{12}}$

Table 3.31: Keys in Phase diagram screen

F1	HOLD	Holds measurement on display.
	RUN	Runs held measurement.
F2	U I	Selects voltage for scaling (with cursors).
	I U	Selects current for scaling (with cursors).
	METER	Switches to PHASE DIAGRAM view.
F4	UNBAL.	Switches to UNBALANCE DIAGRAM view.
	TREND	Switches to TREND view (available only during recording).



Scales voltage or current phasors.



Triggers Waveform snapshot.



Returns to the “MEASUREMENTS” submenu.

3.10.2 Unbalance diagram

Unbalance diagram represents current and voltage unbalance of the measuring system. Unbalance arises when RMS values or phase angles between consecutive phases are not equal. Diagram is shown on figure below.

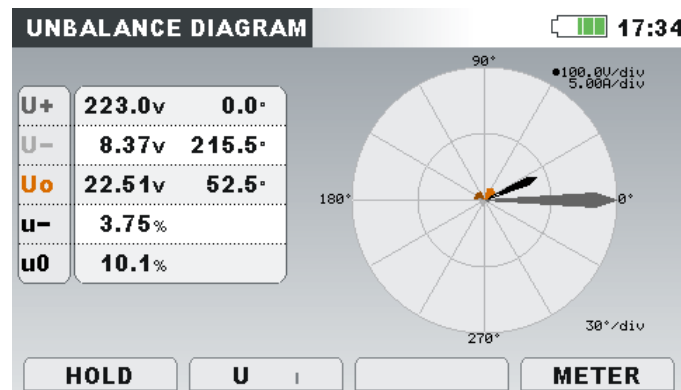







Figure 3.35: Unbalance diagram screen

Table 3.32: Instrument screen symbols and abbreviations

U0	Zero sequence voltage component U^0
I0	Zero sequence current component I^0
U+	Positive sequence voltage component U^+
I+	Positive sequence current component I^+
U-	Negative sequence voltage component U^-
I-	Negative sequence current component I^-
u-	Negative sequence voltage ratio u^-
i-	Negative sequence current ratio i^-
u0	Zero sequence voltage ratio u^0
i0	Zero sequence current ratio i^0

Table 3.33: Keys in Unbalance diagram screens

	HOLD	Holds measurement on display.
	RUN	Runs held measurement.
	U I	Shows voltage unbalance measurement and selects voltage for scaling (with cursors)
	I U	Shows current unbalance measurement and selects current for scaling (with cursors)
	METER	Switches to PHASE DIAGRAM view.
	UNBAL.	Switches to UNBALANCE DIAGRAM view.
	TREND	Switches to TREND view (available only during recording).
		Scales voltage or current phasors.
		Triggers Waveform snapshot.
		Returns to the “MEASUREMENTS” submenu.

3.10.3 Unbalance trend

During active recording UNBALANCE TREND view is available (see section 3.13 for instructions how to start GENERAL RECORDER).

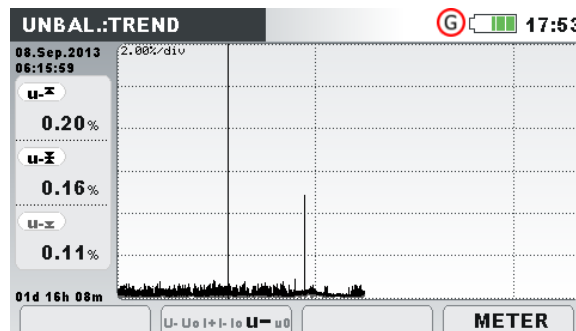





















Figure 3.36: Symmetry trend screen

Table 3.34: Instrument screen symbols and abbreviations

u-	Maximal () , average () and minimal () value of negative sequence voltage ratio u-
u0	Maximal () , average () and minimal () value of zero sequence voltage ratio u ⁰
i-	Maximal () , average () and minimal () value of negative sequence current ratio i-
i0	Maximal () , average () and minimal () value of zero sequence current ratio i ⁰
U+	Maximal () , average () and minimal () value of positive sequence voltage U ⁺
U-	Maximal () , average () and minimal () value of negative sequence voltage U ⁻

U0	Maximal (⚡), average (⚡) and minimal (⚡) value of zero sequence voltage U^0
I+	Maximal (⚡), average (⚡) and minimal (⚡) value of positive sequence current I^+
I-	Maximal (⚡), average (⚡) and minimal (⚡) value of negative sequence current I^-
I0	Maximal (⚡), average (⚡) and minimal (⚡) value of zero sequence current I^0

Table 3.35: Keys in Unbalance trend screens

F2	U+ U- U0 I+ I- I0 u+ u0 i+ i0	Shows selected voltage and current unbalance measurement ($U^+, U^-, U^0, I^+, I^-, I^0, u^-, u^0, i^-, i^0$).
	METER	Switches to PHASE DIAGRAM view.
F4	UNBAL.	Switches to UNBALANCE DIAGRAM view.
	TREND	Switches to TREND view (available only during recording).
		Moves cursor and selects time interval (IP) for observation.
ESC		Returns to the “MEASUREMENTS” submenu.

3.11 Temperature

Power Master instrument is capable of measuring and recording temperature with Temperature probe A 1354. Temperature is expressed in both units, Celsius and Fahrenheit degrees. See following sections for instructions how to start recording. In order to learn how to set up neutral clamp input with the temperature sensor, see section 4.2.4.

3.11.1 Meter

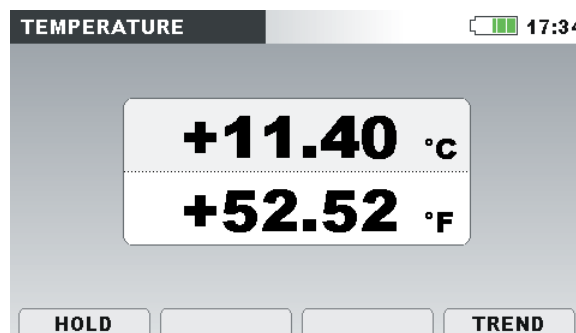



Figure 3.37: Temperature meter screen

Table 3.36: Instrument screen symbols and abbreviations

$^{\circ}C$	Current temperature in Celsius degrees
$^{\circ}F$	Current temperature in Fahrenheit degrees

Table 3.37: Keys in Temperature meter screen

F1	HOLD	Holds measurement on display.
	RUN	Runs held measurement.
F4	METER	Switches to METER view.
	TREND	Switches to TREND view (available only during recording).
		Triggers Waveform snapshot.
ESC		Returns to the “MEASUREMENTS” submenu.

3.11.2 Trend

Temperature measurement TREND can be viewed during the recording in progress. Records containing temperature measurement can be viewed from Memory list and by using PC software PowerView v3.0.

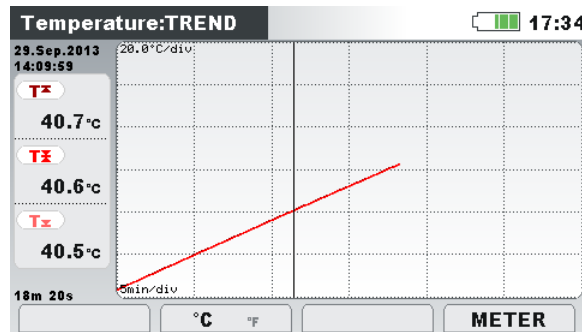

Figure 3.38: Temperature trend screen

Table 3.38: Instrument screen symbols and abbreviations

T:	Maximal (⌘), average (⌘) and minimal (⌘) temperature value for last recorded time interval (IP)
----	---

Table 3.39: Keys in Temperature trend screens

F2	°C °F	Shows temperature in Celsius degrees.
	°C °F	Shows temperature in Fahrenheit degrees.
F4	METER	Switches to METER view.
	TREND	Switches to TREND view (available only during recording).
ESC		Returns to the “MEASUREMENTS” submenu.

3.12 Signalling

Mains signalling voltage, called “ripple control signal” in certain applications, is a burst of signals, often applied at a non-harmonic frequency, that remotely control industrial equipment, revenue meters, and other devices. Before observing signalling measurements, user should set-up signalling frequencies in signalling setup menu (see section 3.19.4).

Results can be seen in a tabular (METER) or a graphical form (TREND) - which is active only while GENERAL RECORDER is active. See section 3.13 for instructions how to start recording. In order to understand meanings of particular parameter see section 5.1.8.

3.12.1 Meter

By entering SIGNALLING option from MEASUREMENTS submenu the SIGNALLING tabular screen is shown (see figure below).

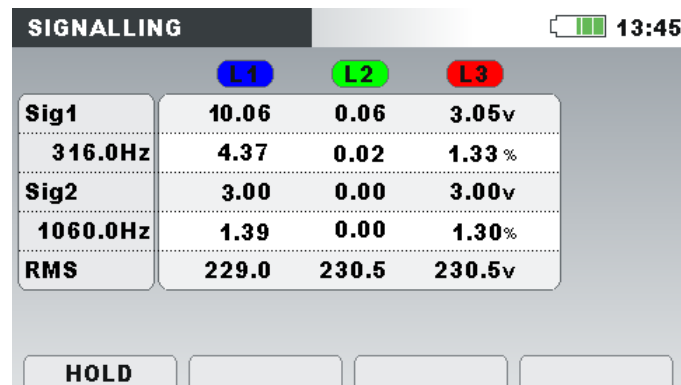





Figure 3.39: Signalling meter screen

Description of symbols and abbreviations used in METER screen is shown in table below.

Table 3.40: Instrument screen symbols and abbreviations

Sig1 316.0 Hz	True effective value signal voltage (U_{Sig1} , U_{Sig2} , U_{Sig3} , U_{Sig12} , U_{Sig23} , U_{Sig31}) for a user-specified carrier frequency (316.0 Hz in shown example) expressed in Volts or percent of fundamental voltage
Sig2 1060.0 Hz	True effective value signal voltage (U_{Sig1} , U_{Sig2} , U_{Sig3} , U_{Sig12} , U_{Sig23} , U_{Sig31}) for a user-specified carrier frequency (1060.0 Hz in shown example) expressed in Volts or percent of fundamental voltage
RMS	True effective value of phase or phase to phase voltage U_{Rms} (U_1 , U_2 , U_3 , U_{12} , U_{23} , U_{31})

Table 3.41: Keys in Signalling (METER) screen

	HOLD	Holds measurement on display.
	RUN	Runs held measurement.
	METER	Switches to METER view.
	TREND	Switches to TREND view (available only during recording).
		Triggers Waveform snapshot.
		Returns to the "MEASUREMENTS" submenu.

3.12.2 Trend

During active recording TREND view is available (see section 3.13 for instructions how to start recording). Signalling parameters can be observed by cycling function key F4 (METER -TREND).

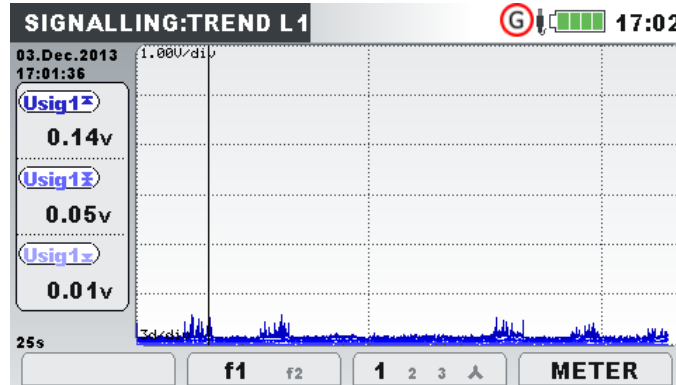





Figure 3.40: Signalling trend screen

Table 3.42: Instrument screen symbols and abbreviations

Usig1, Usig2, Usig3, Usig12, Usig23, Usig31	Maximal (▲), average (⊠) and minimal (▼) value of (U _{Sig1} , U _{Sig2} , U _{Sig3} , U _{Sig12} , U _{Sig23} , U _{Sig31}) signal voltage for a user-specified Sig1/Sig2 frequency (Sig1 = 316.0 Hz / Sig2 = 1060.0 Hz in shown example).
14.Nov.2013 13:50:00	Timestamp of interval (IP) selected by cursor.
22h 25m 00s	Current GENERAL RECORDER time (Days hours:min:sec)

Table 3.43: Keys in Signalling (TREND) screen

F2	f1 f2	Selects between the following options: Shows signal voltage for a user-specified signalling frequency (Sig1).
	f1 f2	Shows signal voltage for a user-specified signalling frequency (Sig2).
F3	1 2 3 ▲	Selects between trending various parameters: Shows signalling for phase 1
	1 2 3 ▲	Shows signalling for phase 2
	1 2 3 ▲	Shows signalling for phase 3
	1 2 3 ▲	Shows signalling for all phases (average only)
	12 23 31 Δ	Shows signalling for phase to phase voltage L12.
	12 23 31 Δ	Shows signalling for phase to phase voltage L23.
	12 23 31 Δ	Shows signalling for phase to phase voltage L31.
12 23 31 Δ	Shows signalling for all phase to phase voltages (average only).	

	METER	Switches to METER view.
	TREND	Switches to TREND view (available only during recording).
		Moves cursor and select time interval (IP) for observation.
		Returns to the "MEASUREMENTS" submenu.

3.13 General Recorder

Power Master has ability to record measured data in the background. By entering GENERAL RECORDER option from RECORDERS submenu, recorder parameters can be customized in order to meet criteria about interval, and the number of signals for the recording campaign. The following screen is shown:

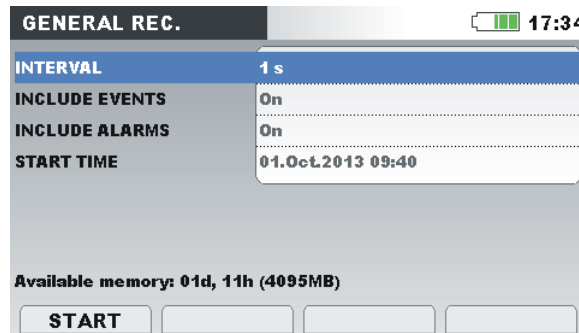

Figure 3.41: General recorder setup screen

Description of General recorder settings is given in the following table:

Table 3.44: General recorder settings description and screen symbols











	General recorder is active, waiting for trigger
	General recorder is active, recording in progress
Interval	Select General recorder aggregation interval. The smaller the interval is, more measurements will be used for the same record duration.
Include events	Select whether events are included in the record.
Include alarms	Select whether alarms are included in the record.
Start time	Define start time of recording: <ul style="list-style-type: none"> • Manual, pressing function key F1 • At the given time and date.

Table 3.45: Keys in General recorder setup screen

	START	Starts the recorder.
	STOP	Stops the recorder.
		Enters recorder starting date/time setup.

Keys in Set start time window:

	Selects parameter to be changed.
	Modifies parameter.
	Confirms selected option.
	Exits Set start time window without modifications.
	Selects parameter to be changed.
	Modifies parameter.
	Returns to the "RECORDERS" submenu.

3.14 Waveform/inrush recorder

Waveform recording is a powerful tool for troubleshooting and capturing current and voltage waveforms and inrushes. Waveform recorder saves a defined number of periods of voltage and current on a trigger occurrence. Each recording consists of pre-trigger interval (before trigger) and post-trigger interval (after trigger).

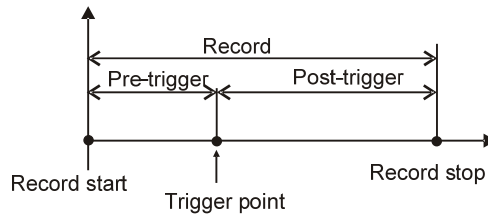

Figure 3.42: Triggering in waveform record

3.14.1 Setup

By entering WAVEFORM RECORDER from the RECORDERS submenu the following setup screen is shown:

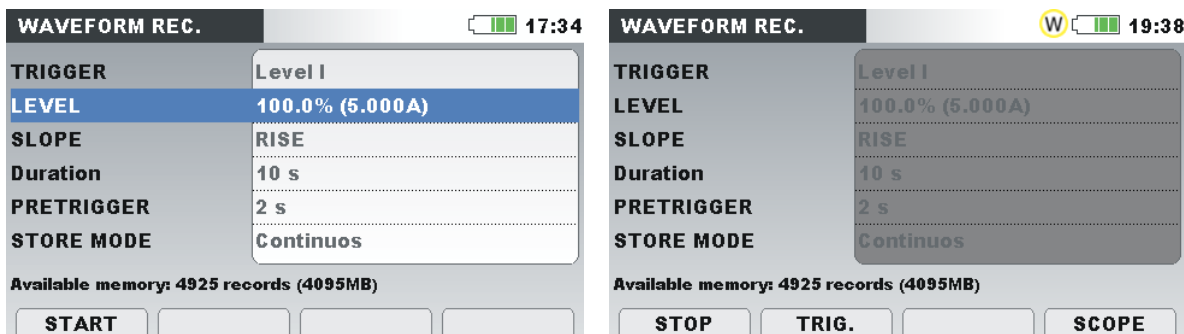

Figure 3.43: Waveform recorder setup screen

Table 3.46: Waveform recorder settings description and screen symbols

	Waveform recorder is active, waiting for trigger
	Waveform recorder is active, recording in progress
Trigger	<p>Trigger source set up:</p> <ul style="list-style-type: none"> • Events – triggered by voltage event (see 3.19.2); • Alarms – triggered by alarm activation (see 3.19.3); • Events & Alarms – triggered by alarm or event; • Level U – triggered by voltage level; • Level I – triggered by current level (inrush).
Level*	Voltage or current level in % of nominal voltage or current and in (V or A), which will trigger recording
Slope*	<ul style="list-style-type: none"> • Rise – triggering will occur only if voltage or current rise above given level • Fall - triggering will occur only if voltage or current fall below given level • Any – triggering will occur if voltage or current rise above or fall below given level
Duration	Record length.
Pretrigger	Recorded interval before triggering occurs.
Store mode	<p>Store mode setup:</p> <ul style="list-style-type: none"> • Single – waveform recording ends after first trigger; • Continuous – consecutive waveform recording until user stops the measurement or instrument runs out of storage memory. Every consecutive waveform recording will be treated as a separate record. Maximal 200 records can be recorded.

* Available only if Level U or Level I triggering is selected.

Table 3.47: Keys in Waveform recorder setup screen

	START STOP	<p>Starts waveform recording. Stops waveform recording.</p> <p>Note: If user forces waveform recorder to stop before trigger occurs, no data will be recorded. Data recording occurs only when trigger is activated.</p>
	TRIG.	Manually generates trigger condition and starts recording.
	SCOPE	Switches to SCOPE view. (Active only if recording in progress).
		Selects parameter to be changed.
		Modifies parameter.
		Returns to the “RECORDERS” submenu.

3.14.2 Capturing waveform

Following screen opens when a user switches to SCOPE view.

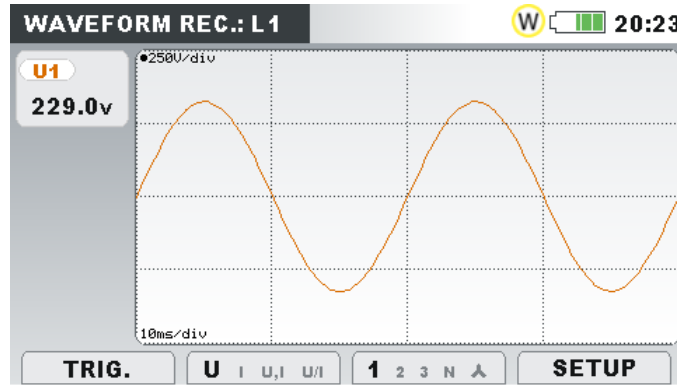

Figure 3.44: Waveform recorder capture screen

Table 3.48: Instrument screen symbols and abbreviations

	Waveform recorder is active, waiting for trigger
	Waveform recorder is active, recording in progress
U1, U2, U3, Un	True effective value of phase voltage: $U_{1Rms}, U_{2Rms}, U_{3Rms}, U_{NRms}$
U12, U23, U31	True effective value of phase-to-phase (line) voltage: $U_{12Rms}, U_{23Rms}, U_{31Rms}$
I1, I2, I3, In	True effective value of current: $I_{1Rms}, I_{2Rms}, I_{3Rms}, I_{NRms}$

Table 3.49: Keys in Waveform recorder capture screen

	TRIG.	Manually generates trigger condition (Active only if recording is in progress).
		Selects which waveforms to show: Shows voltage waveform.
		Shows current waveform.
		Shows voltage and current waveforms on single graph.
		Shows voltage and current waveforms on separate graphs.
		Selects between phase, neutral, all-phases and line view: Shows waveforms for phase L1.
		Shows waveforms for phase L2.
		Shows waveforms for phase L3.
		Shows waveforms for neutral channel.
		Shows waveforms for all phases.
		Shows waveforms for phase to phase voltage L12.
		Shows waveforms for phase to phase voltage L23.
		Shows waveforms for phase to phase voltage L31.
	Shows waveforms for all phase-to-phase voltages.	
	SETUP	Switches to SETUP view. (Active only if recording in progress).
		Selects which waveform to zoom (only in U,I or U/I).
		Sets vertical zoom.

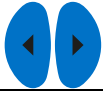

Sets horizontal zoom.



Returns to the “WAVEFORM RECORDER” setup screen.

3.14.3 Captured waveform

Captured waveforms can be viewed from the Memory list menu.

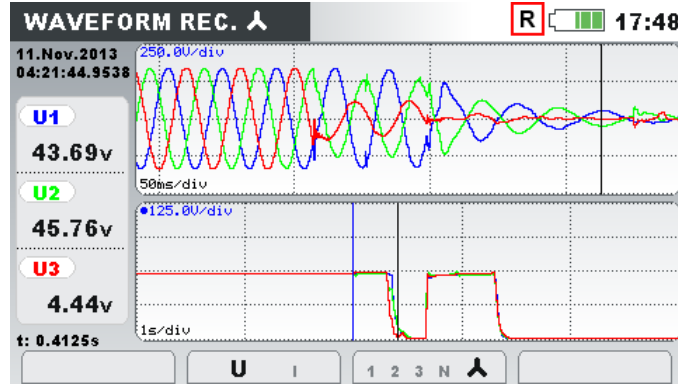

Figure 3.45: Captured waveform recorder screen

Table 3.50: Instrument screen symbols and abbreviations

R	Memory list recall. Shown screen is recalled from memory
t:	Cursor position in seconds (regarding to trigger time – blue line on graph)
u1(t), u2(t), u3(t), un(t)	Samples value of phase voltages U_1, U_2, U_3, U_N .
u12(t), u23(t), u31(t)	Samples value of phase to phase voltages U_{12}, U_{23}, U_{31} .
i1(t), i2(t), i3(t), in(t)	Samples value of phase currents I_1, I_2, I_3, I_N .
U1, U2, U3, Un	True effective half cycle phase voltage $U_{Rms\frac{1}{2}}$
U12, U23, U31	True effective half cycle phase to phase voltage $U_{Rms\frac{1}{2}}$
I1, I2, I3, In	True effective half cycle value $I_{Rms\frac{1}{2}}$

Table 3.51: Keys in captured waveform recorder screens

		Selects between the following options:
F2	U U, I U/I	Shows voltage waveform.
	I U, I U/I	Shows current waveform.
	U U , I U/I	Shows voltage and current waveforms (single mode).
	U U, I U /I	Shows voltage and current waveforms (dual mode).
F3		Selects between phase, neutral, all-phases and view:
	1 2 3 N ^	Shows waveforms for phase L1.
	1 2 3 N ^	Shows waveforms for phase L2.
	1 2 3 N ^	Shows waveforms for phase L3.
	1 2 3 N ^	Shows waveforms for neutral channel.
1 2 3 N ^	Shows all phases waveforms.	

	Shows waveforms for phase to phase voltage L12.
	Shows waveforms for phase to phase voltage L23.
	Shows waveforms for phase to phase voltage L31.
	Shows all phase-to-phase waveforms.
	Sets vertical zoom.
	Moves cursor.
	Toggles between sample value and true effective half cycle value at cursor position. Toggles cursor between voltage and current (only in U,I or U/I).
	Returns to the “MEMORY LIST” submenu.

3.15 Transient recorder

Transient is a term for **short, highly damped** momentary voltage or current disturbance. A transient recording is recording with the 51.2 kHz sampling rate. The principle of measurement is similar to waveform recording, but with a 10 times higher sampling rate (1024 samples per period). In contrary to waveform recording, where recording is triggered based on RMS values, trigger in transient recorder is based on sample values.

3.15.1 Setup

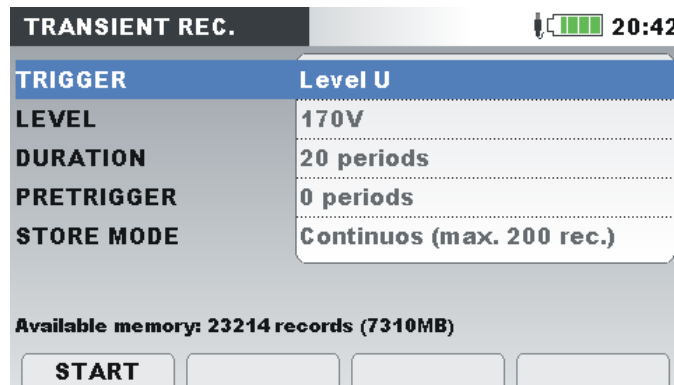

Figure 3.46: Transient recorder setup screen

Table 3.52: Transient recorder settings description and screen symbols

	Transient recorder is active, waiting for trigger
	Transient recorder is active, recording in progress
Trigger (Envelope)	Trigger value is based on envelope within voltage that is expected. As reference, voltage waveform from previous cycle is taken. If current sample is not within envelope, triggering will occur. See 5.1.16 for details.

Level	Envelope voltage level
	Trigger will occur if any sample within period is greater than defined absolute trigger level. See 5.1.16 for details.
Trigger (Level U)	
Level	Absolute trigger level in voltage
Duration	Record length.
Pretrigger	Recorded intervals before triggering occur.
Store mode	Store mode setup: <ul style="list-style-type: none"> • Single – transient recording ends after first trigger • Continuous – consecutive transient recording until user stops the measurement or instrument runs out of storage memory. Every consecutive transient recording will be treated as a separate record. Maximal 200 records can be recorded.

Table 3.53: Keys in Transient recorder setup screen

	START STOP	Starts transient recorder. Stops transient recorder. Note: If user forces transient recorder to stop before trigger occurs, no data is recorded. Data recording occurs only when trigger is activated.
	TRIG.	Manually generates trigger condition and starts recording.
	SCOPE	Switches to SCOPE view (<i>Active only if recording in progress</i>).
		Selects parameter to be changed.
		Modifies parameter.
		Returns to the “RECORDERS” submenu.

3.15.2 Capturing transients

After transient recorder is started, instrument waits for trigger occurrence. This can be seen by observing status bar, where icon is present. If trigger conditions are met, recording will be started.

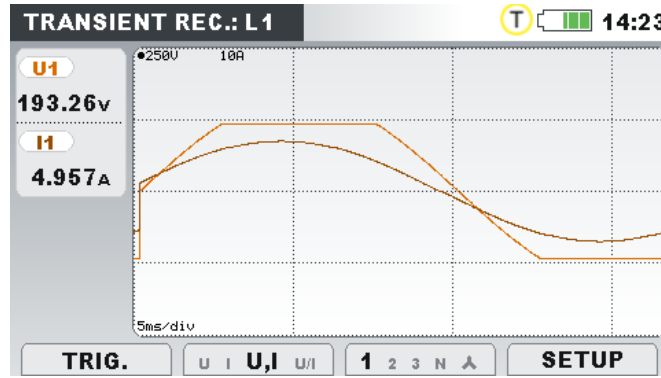

Figure 3.47: Transient recorder capture screen

Table 3.54: Instrument screen symbols and abbreviations

	Transient recorder is active, waiting for trigger
	Transient recorder is active, recording in progress
U1, U2, U3, Un	True effective value of phase voltage: U_{1Rms} , U_{2Rms} , U_{3Rms} , U_{NRms}
U12, U23, U31	True effective value of phase-to-phase voltage: U_{12Rms} , U_{23Rms} , U_{31Rms}
I1, I2, I3, In	True effective value of current: I_{1Rms} , I_{2Rms} , I_{3Rms} , I_{NRms}

Table 3.55: Keys in Transient recorder capture screen

	TRIG.	Manually generates trigger condition (Active only if recording is in progress).
	 	Selects which waveforms to show: Shows voltage waveform. Shows current waveform. Shows voltage and current waveforms on single graph. Shows voltage and current waveforms on separate graphs.
	 	Selects between phase, neutral, all-phases and line view: Shows waveforms for phase L1. Shows waveforms for phase L2. Shows waveforms for phase L3. Shows waveforms for neutral channel. Shows waveforms for all phases. Shows waveforms for phase to phase voltage L12. Shows waveforms for phase to phase voltage L23. Shows waveforms for phase to phase voltage L31. Shows waveforms for all phase-to-phase voltages.
	SETUP	Switches to SETUP view (Active only if recording in progress).
		Sets vertical zoom.
		Selects which waveform to zoom (only in U,I or U/I).

ESC Returns to the “TRANSIENT RECORDER” setup screen.

3.15.3 Captured transients

Captured transient records can be viewed from the Memory list where captured waveforms can be analysed. Trigger occurrence is marked with the blue line, while cursor position line is marked in black.

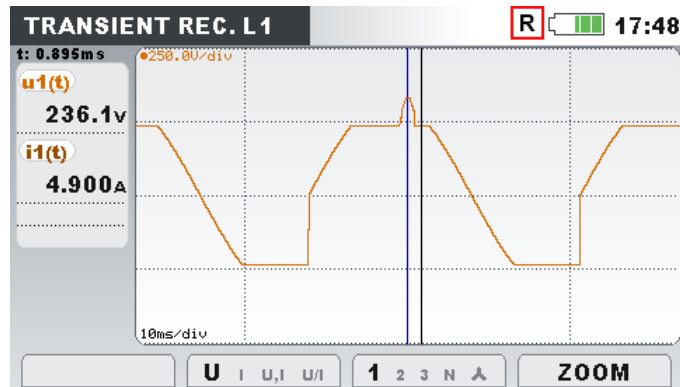

Figure 3.48: Captured transient recorder screen

Table 3.56: Instrument screen symbols and abbreviations

R	Memory list recall. Shown screen is recalled from memory
t:	Cursor position regarding to trigger time (blue line on graph)
u1(t), u2(t), u3(t), un(t)	Samples value of phase voltages U_1, U_2, U_3, U_N .
u12(t), u23(t), u31(t)	Samples value of phase to phase voltages U_{12}, U_{23}, U_{31} .
i1(t), i2(t), i3(t), in(t)	Samples value of phase currents I_1, I_2, I_3, I_N .

Table 3.57: Keys in captured transient recorder screens

		Selects between the following options:
F2	U U, I U/I	Shows voltage waveform.
	U U, I U/I	Shows current waveform.
	U U , I U/I	Shows voltage and current waveforms (single mode).
	U U, I U I	Shows voltage and current waveforms (dual mode).
		Selects between phase, neutral, all-phases and view:
F3	1 2 3 N ^	Shows waveforms for phase L1.
	1 2 3 N ^	Shows waveforms for phase L2.
	1 2 3 N ^	Shows waveforms for phase L3.
	1 2 3 N ^	Shows waveforms for neutral channel.
	1 2 3 N ^	Shows waveforms for all phases.
	12 23 31 Δ	Shows waveforms for phase to phase voltage L12.
	12 23 31 Δ	Shows waveforms for phase to phase voltage L23.
	12 23 31 Δ	Shows waveforms for phase to phase voltage L31.

	Shows waveforms for all phase-to-phase voltages.
	ZOOM Sets horizontal zoom
	Sets vertical zoom.
	Moves cursor.
	Toggles cursor between voltage and current (only in U,I or U/I).
	Returns to the “MEMORY LIST” submenu.

3.16 Events table

In this table captured voltage dips, swells and interrupts are shown. Note that events appear in the table after finishing, when voltage return to the normal value. All events can be grouped according to IEC 61000-4-30. Additionally for troubleshooting purposes events can be separated by phase. This is toggled by pressing function key F1.

Group view

In this view voltage event are grouped according to IEC 61000-4-30 (see section 5.1.11 for details). Table where events are summarized is shown below. Each line in table represents one event, described by event number, event start time, duration and level. Additionally in colon “T” event characteristics (Type) is shown (see table below for details).

EVENTS					
Date 13.09.2013					
No	L	START	T	Level	Duration
1	1	08:42:18.048	D	135.64	0h00m0.060s
2	1	08:42:20.048	D	135.66	0h00m0.060s
3	1	08:42:28.048	D	135.64	0h00m0.060s
4	12	08:42:30.045	D	135.64	0h00m0.090s
5	12	08:42:32.045	D	135.63	0h00m0.090s
6	12	08:42:34.045	D	135.64	0h00m0.090s
7	2	08:42:36.045	D	160.96	0h00m0.090s

Ph. STAT

Figure 3.49: Voltage events in group view screen

By pressing “ENTER” on particular event we can examine event details. Event is split by phase events sorted by start time.

No.	L	START	T	Level	Duration
4	2	08:42:30.045	D	160.87	0h00m0.090s
5	1	08:42:30.049	D	135.64	0h00m0.060s

Figure 3.50: Voltage events in detail view screen

Table 3.58: Instrument screen symbols and abbreviations

Date	Date when selected event has occurred
No.	Unified event number (ID)
L	Indicate phase or phase-to-phase voltage where event has occurred: 1 – event on phase U_1 2 – event on phase U_2 3 – event on phase U_3 12 – event on voltage U_{12} 23 – event on voltage U_{23} 31 – event on voltage U_{31} Note: This indication is shown only in event details, since one grouped event can have many phase events.
Start	Event start time (when first $U_{Rms\frac{1}{2}}$ value crosses threshold.
T	Indicates type of event or transition: D – Dip I – Interrupt S – Swell
Level	Minimal or maximal value in event U_{Dip} , U_{Int} , U_{Swell}
Duration	Event duration.

Table 3.59: Keys in Events table group view screens

		Group view is shown. Press to switch on “PHASE” view.
		Phase view is shown. Press to switch on “GROUP” view.
		Shows event statistics.

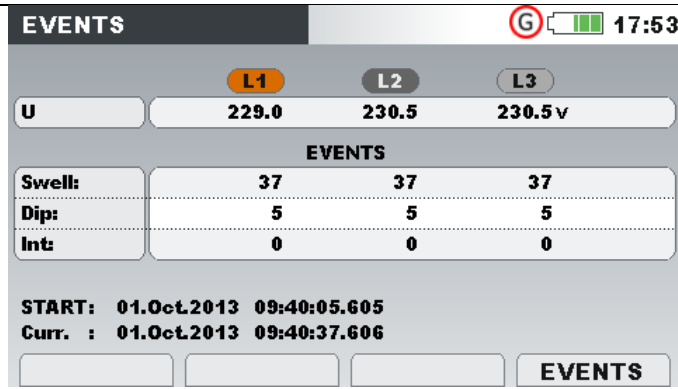

EVENTS Returns to “EVENTS” view.

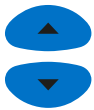

Selects event.



Enters detail event view.



Returns to Events table group view screen.
Returns to “RECORDERS” submenu.

Phase view

In this view voltage events are separated by phases. This is convenient view for troubleshooting. Additionally user can use filters in order to observe only particular type of event on a specific phase. Captured events are shown in a table, where each line contains one phase event. Each event has an event number, event start time, duration and level. Additionally in colon “T” type of event is shown (see table below for details).

The screenshot shows the 'EVENTS' screen in phase view. It displays a table of event details with columns for No., L, START, T, Level, and Duration. The date is 13.09.2013. The table contains 7 rows of event data. At the bottom, there are filter buttons for 'Ph.' and 'STAT'.

No.	L	START	T	Level	Duration
1	1	08:42:18.048	D	135.64	0h00m0.060s
2	1	08:42:20.048	D	135.66	0h00m0.060s
3	1	08:42:28.048	D	135.64	0h00m0.060s
4	12	08:42:30.045	D	135.64	0h00m0.090s
5	12	08:42:32.045	D	135.63	0h00m0.090s
6	12	08:42:34.045	D	135.64	0h00m0.090s
7	2	08:42:36.045	D	160.96	0h00m0.090s

Figure 3.51: Voltage events screens













You can also see details of each individual voltage event and statistics of all events. Statistics show count registers for each individual event type by phase.

Table 3.60: Instrument screen symbols and abbreviations

Date	Date when selected event has occurred
No.	Unified event number (ID)
L	Indicate phase or phase-to-phase voltage where event has occurred:

	1 – event on phase U_1 2 – event on phase U_2 3 – event on phase U_3 12 – event on voltage U_{12} 23 – event on voltage U_{23} 31 – event on voltage U_{31}
Start	Event start time (when first $U_{Rms\frac{1}{2}}$ value crosses threshold.
T	Indicates type of event or transition: D – Dip I – Interrupt S – Swell
Level	Minimal or maximal value in event U_{Dip} , U_{Int} , U_{Swell}
Duration	Event duration.

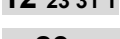
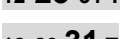
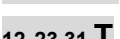
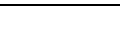
Table 3.61: Keys in Events table phase view screens

F1		Group view is shown. Press to switch on “PHASE” view.
		Phase view is shown. Press to switch on “GROUP” view.
F2		Filters events by type: Shows all event types.
		Shows dips only.
		Shows interrupts only.
		Shows swells only.
F3		Filters events by phase: Shows only events on phase L1.
		Shows only events on phase L2.
		Shows only events on phase L3.
		Shows events on all phases.
		Shows only events on phases L12.
		Shows only events on phases L23.
		Shows only events on phases L31.
		Shows events on all phases.
F4		Shows event summary (by types and phases).

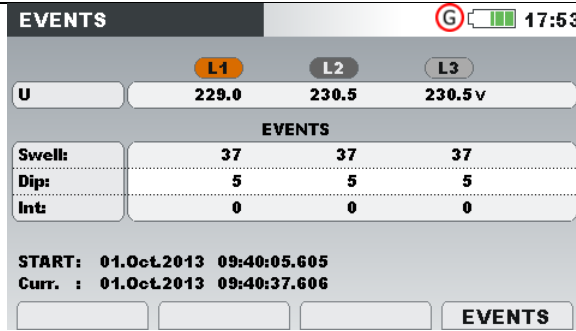

EVENTS Returns to EVENTS view.

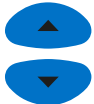

Selects event.



Enters detail event view.



Returns to Events table phase view screen.
Returns to the "RECORDERS" submenu.

3.17 Alarms table

This screen shows list of alarms which went off. Alarms are displayed in a table, where each row represents an alarm. Each alarm is associated with a start time, phase, type, slope, min/max value and duration (see 3.19.3 for alarm setup and 5.1.12 for alarm measurement details).

START	L	T	Slope	Min/Max	Duration
08:38:31.799	1	I	Rise	1000 A	22.200 sec
08:38:31.799	T	P+	Rise	681.2 kW	52.400 sec
08:40:00.199	T	P+	Rise	302.0 kW	12.000 sec
08:40:46.199	1	Uh3	Rise	9.83 %	15.800 sec
08:41:16.399	1	I	Rise	900.1 A	15.600 sec
08:41:16.399	T	P+	Rise	260.2 kW	15.800 sec























Figure 3.52: Alarms list screen

Table 3.62: Instrument screen symbols and abbreviations

Date	Date when selected alarm has occurred
Start	Selected alarm start time (when first U_{Rms} value cross threshold)
L	Indicate phase or phase-to-phase voltage where event has occurred: 1 – alarm on phase L ₁ 2 – alarm on phase L ₂ 3 – alarm on phase L ₃ 12 – alarm on line L ₁₂ 23 – alarm on line L ₂₃ 31 – alarm on line L ₃₁
Slope	Indicates alarms transition: • Rise – parameter has over-crossed threshold

	• Fall – parameter has under-crossed threshold
Min/Max	Minimal or maximal parameter value during alarm occurrence
Duration	Alarm duration.

Table 3.63: Keys in Alarms table screens

		Filters alarms according to the following parameters:
	 UIF C. Pwr F. Pwr NF. Pwr Flick Sym H iH Sig Temp	All alarms.
	 UIF C. Pwr F. Pwr NF. Pwr Flick Sym H iH Sig Temp	Voltage alarms.
	 UIF C. Pwr F. Pwr NF. Pwr Flick Sym H iH Sig Temp	Combined power alarms.
	 UIF C. Pwr F. Pwr NF. Pwr Flick Sym H iH Sig Temp	Fundamental power alarms.
	 UIF C. Pwr F. Pwr NF. Pwr Flick Sym H iH Sig Temp	Nonfundamental power alarms.
	 UIF C. Pwr F. Pwr NF. Pwr Flick Sym H iH Sig Temp	Flicker alarms.
	 UIF C. Pwr F. Pwr NF. Pwr Flick Sym H iH Sig Temp	Unbalance alarms.
	 UIF C. Pwr F. Pwr NF. Pwr Flick Sym H iH Sig Temp	Harmonics alarms.
	 UIF C. Pwr F. Pwr NF. Pwr Flick Sym H iH Sig Temp	Interharmonics alarms.
	 UIF C. Pwr F. Pwr NF. Pwr Flick Sym H iH Sig Temp	Signalling alarms.
	 UIF C. Pwr F. Pwr NF. Pwr Flick Sym H iH Sig Temp	Temperature alarms.
		Filters alarms according to phase on which they occurred:
	1 2 3 N 12 23 31 T 	Shows only alarms on phase L1.
	1 2 3 N 12 23 31 T 	Shows only alarms on phase L2.
	1 2 3 N 12 23 31 T 	Shows only alarms on phase L3.
	1 2 3 N 12 23 31 T 	Shows only alarms on neutral channel.
	1 2 3 N 12 23 31 T 	Shows only alarms on phases L12.
	1 2 3 N 12 23 31 T 	Shows only alarms on phases L23.
	1 2 3 N 12 23 31 T 	Shows only alarms on phases L31.
	1 2 3 N 12 23 31 T 	Shows only alarms on channels which are not channel dependent
	1 2 3 N 12 23 31 T 	Shows all alarms.
		Selects an alarm.



Returns to the “RECORDERS” submenu.

3.18 Memory List

Using this menu user can view and browse saved records. By entering this menu, information about records is shown.

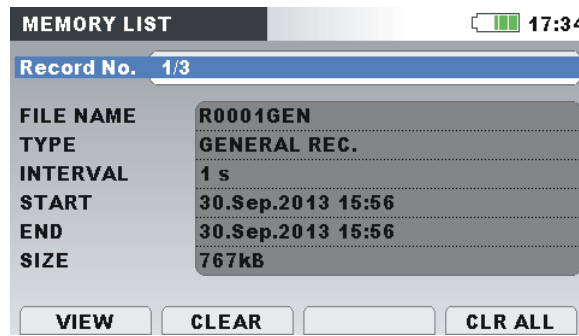







Figure 3.53: Memory list screen

Table 3.64: Instrument screen symbols and abbreviations

Record No	Selected record number, for which details are shown.
FILE NAME	Record name on SD Card
Type	Indicates type of record, which can be one of following: <ul style="list-style-type: none"> • Snapshot, • Transient record, • Waveform/inrush record, • General record.
Interval	General record recording interval (integration period)
Trigger	Trigger used for capturing waveform and transient record
Level	Trigger level
Slope	Trigger slope
Duration	Record duration
Start	General record start time.
End	General record stop time.
Size	Record size in kilobytes (kB) or megabytes (MB).

Table 3.65: Keys in Memory list screen

F1	VIEW	Views details of currently selected record.
F2	CLEAR	Clears selected record.
F4	CLR ALL	Opens confirmation window for clearing all saved records. Keys in confirmation window:

	Selects YES or NO.
	Confirms selection.
	Exits confirmation window without clearing saved records.
	Browses through records (next or previous record).
	Returns to the "RECORDERS" submenu.

3.18.1 General Record

This type of record is made by GENERAL RECORDER. Record front page is similar to the GENERAL RECORDER setup screen, as shown on figure below.



Figure 3.54: Front page of General record in MEMORY LIST menu

Table 3.66: Recorder settings description

Record No.	Selected record number, for which details are shown.
FILE NAME	Record name on SD Card
Type	Indicate type of record: <ul style="list-style-type: none"> • General record.
Interval	General record recording interval (integration period)
Start	General record start time.
End	General record stop time.
Size	Record size in kilobytes (kB) or megabytes (MB).

Table 3.67: Keys in General record front page screen

	VIEW	Switches to the CHANNELS SETUP menu screen. Particular signal groups can be observed by pressing on F1 key (VIEW).
---	-------------	---

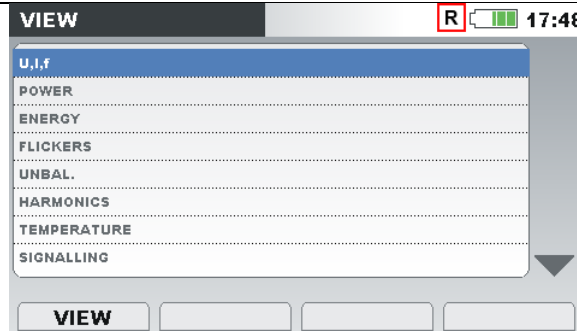

Keys in CHANNELS SETUP menu screen:



Selects particular signal group.



Enters particular signal group (TREND view).



Exits to MEMORY LIST menu.



CLEAR

Clears the last record. In order to clear complete memory, delete records one by one.

Opens confirmation window for clearing all saved records.

Keys in confirmation window:



CLR ALL

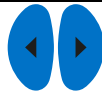

Selects YES or NO.



Confirms selection.



Exits confirmation window without clearing saved records.

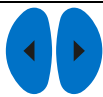

Browses through records (next or previous record).

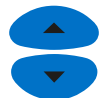

Selects parameter (only in CHANNELS SETUP menu).



Returns to the "RECORDERS" submenu.

By pressing  **VIEW**, in CHANNELS SETUP menu, TREND graph of selected channel group will appear on the screen. Typical screen is shown on figure below.

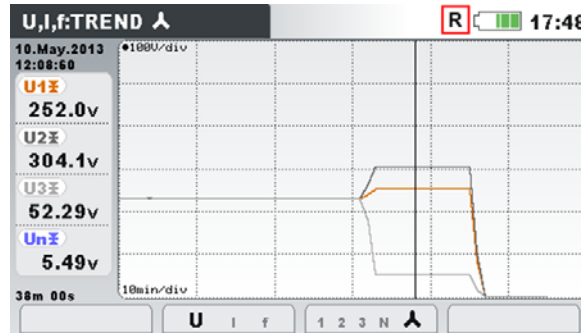

Figure 3.55: Viewing recorder U,I,f TREND data

Table 3.68: Instrument screen symbols and abbreviations

R	Memory list recall. Shown screen is recalled from memory.
	Indicates position of the cursor at the graph.
U1, U2 U3, Un:	Maximal (▲), average (⊗) and minimal (▼) recorded value of phase voltage U_{1Rms} , U_{2Rms} , U_{3Rms} , U_{NRms} , for time interval selected by cursor.
U12, U23, U31	Maximal (▲), average (⊗) and minimal (▼) recorded value of phase-to-phase voltage U_{12Rms} , U_{23Rms} , U_{31Rms} for time interval selected by cursor.
Ip:	Maximal (▲), average (⊗) and minimal (▼) recorded value of current I_{1Rms} , I_{2Rms} , I_{3Rms} , I_{NRms} , for time interval selected by cursor.
38m 00s	Time position of cursor regarding to the record start time.
10.May.2013 12:08:50	Time clock at cursor position.

Table 3.69: Keys in Viewing recorder U,I,f TREND screens

		Selects between the following options:
F2	U I f U, I U/I	Shows voltage trend.
	U I f U, I U/I	Shows current trend.
	U I f U, I U/I	Shows frequency trend.
	U I f U, I U/I	Shows voltage and current trends (single mode).
	U I f U, I U/I	Shows voltage and current trends (dual mode).
		Selects between phase, neutral, all-phases and view:
F3	1 2 3 N ▲	Shows trend for phase L1.
	1 2 3 N ▲	Shows trend for phase L2.
	1 2 3 N ▲	Shows trend for phase L3.
	1 2 3 N ▲	Shows trend for neutral channel.
	1 2 3 N ▲	Shows all phases trends.
	1 2 3 1 Δ	Shows trend for phases L12.

	Shows trend for phases L23.
	Shows trend for phases L31.
	Shows all phase to phase trends.
	Moves cursor and select time interval (IP) for observation.
	Returns to the “CHANNELS SETUP” menu screen.

Note: Other recorded data (power, harmonics, etc.) has similar manipulation principle as described in previous sections of this manual.

3.18.2 Waveform snapshot

This type of record can be made by using key (press and hold key).

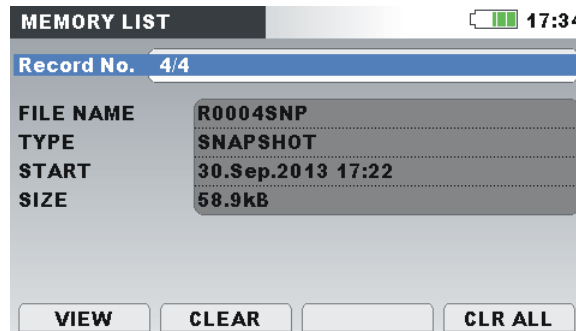

Figure 3.56: Front page of Snapshot in MEMORY LIST menu

Table 3.70: Recorder settings description

Record No.	Selected record number, for which details are shown.
FILE NAME	Record name on SD Card
Type	Indicate type of record: <ul style="list-style-type: none"> • Snapshot.
Start	Record start time.
Size	Record size in kilobytes (kB).

Table 3.71: Keys in Snapshot record front page screen

	Switches to CHANNELS SETUP menu screen.
	VIEW Particular signal group can be observed by pressing on F1 key (VIEW).

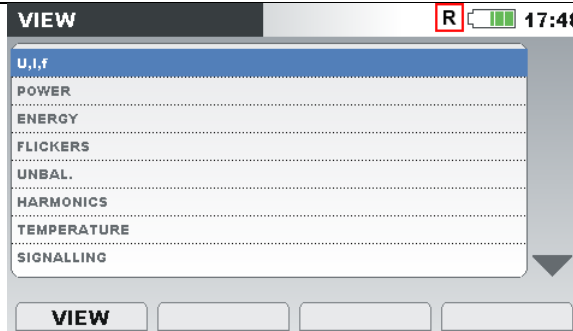

Keys in CHANNELS SETUP menu screen:



Selects particular signal group.



Enters particular signal group (METER or SCOPE view).



Exits to MEMORY LIST menu.



CLEAR

Clears the last record. In order to clear complete memory, delete records one by one.

Opens confirmation window for clearing all saved records.

Keys in confirmation window:



CLR ALL

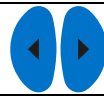

Selects YES or NO.



Confirms selection.



Exits confirmation window without clearing saved records.

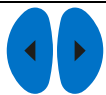

Browses through records (next or previous record).



Returns to the "RECORDERS" submenu.

By pressing **F1 VIEW** in CHANNELS SETUP menu METER screen will appear. Typical screen is shown on figure below.

	L1	L2	L3	N
UL	220.2	225.2	215.2v	9.994v
ThdU	4.54	0.10	0.11%	0.08%
IL	500.0	400.0	300.0A	0.858A
ThdI	0.0	0.068	0.083%	7.755%
f	50.00 Hz			

Figure 3.57: U,I,f meter screen in recalled snapshot record

Note: For more details regarding manipulation and data observing see previous sections of this manual.

3.18.3 Waveform/inrush record

This type of record is made by Waveform recorder. For details regarding manipulation and data observing see section Captured waveform 3.14.3.

3.18.4 Transients record

This type of record is made by Transient recorder. For details regarding manipulation and data observing see section 3.15.3.

3.19 Measurement Setup submenu

From the “MEASUREMENT SETUP” submenu measurement parameters can be reviewed, configured and saved.

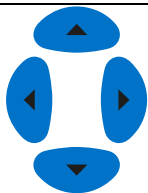

Figure 3.58: MEASUREMENT SETUP submenu

Table 3.72: Description of Measurement setup options

Connection setup	Setup measurement parameters.
Event setup	Setup event parameters.
Alarm setup	Setup alarm parameters.
Signalling setup	Setup signalling parameters.

Table 3.73: Keys in Measurement setup submenu screen



Selects option from the “MEASUREMENT SETUP” submenu.



Enters the selected option.



Returns to the “MAIN MENU” screen.

3.19.1 Connection setup

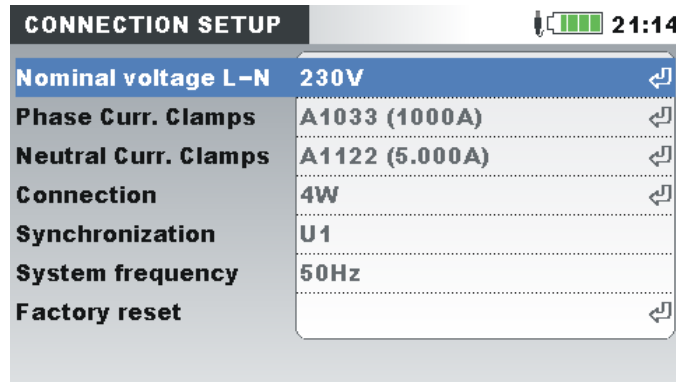
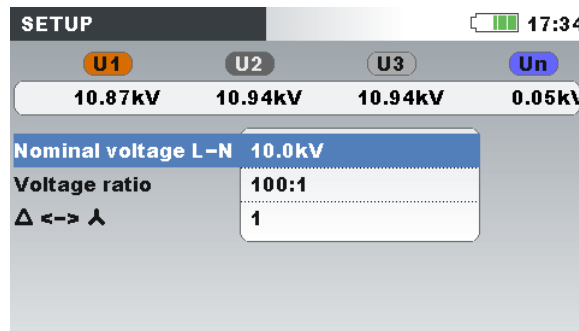

Figure 3.59: "CONNECTION SETUP" screen

Table 3.74: Description of Connection setup

Set nominal voltage. Select voltage according to the network voltage. If voltage is measured over potential transformer then press ENTER for setting transformer parameters:



Nominal voltage

Voltage ratio: Potential transformer ratio $\Delta \leftrightarrow \lambda$:

Transformer type			Additional transformer ratio
Primary	Secondary	Symbol	
Delta	Star	$\Delta \rightarrow \lambda$	1
Star	Delta	$\lambda \rightarrow \Delta$	$\sqrt{3}$
Star	Star	$\lambda \rightarrow \lambda$	$1/\sqrt{3}$
Delta	Delta	$\Delta \rightarrow \Delta$	1

Note: Instrument can always measure accurately at up to 150% of selected nominal voltage.

Phase Curr. Clamps Neutral Curr. Clamps

Selects phase clamps for phase current measurements.

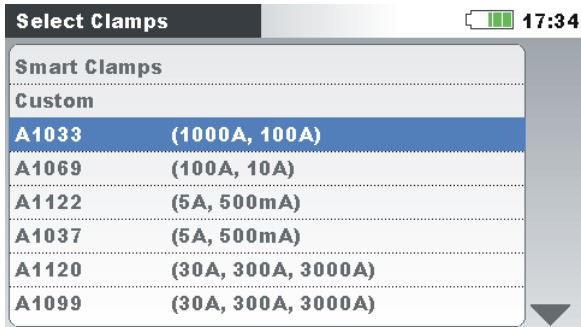

Note: For Smart clamps (A 1227, A 1281) always select “Smart clamps”.

Note: See section 4.2.3 for details regarding further clamps settings.

Method of connecting the instrument to multi-phase systems (see 4.2.1 for details).

- **1W:** 1-phase 2-wire system;

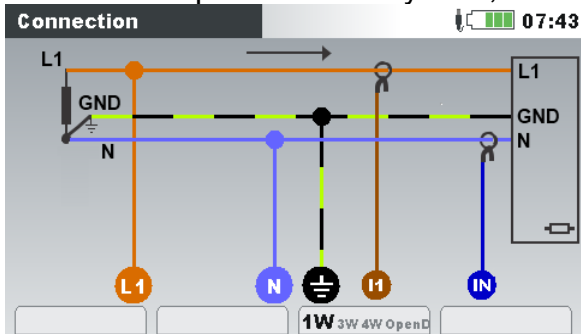

- **3W:** 3-phase 3-wire system;

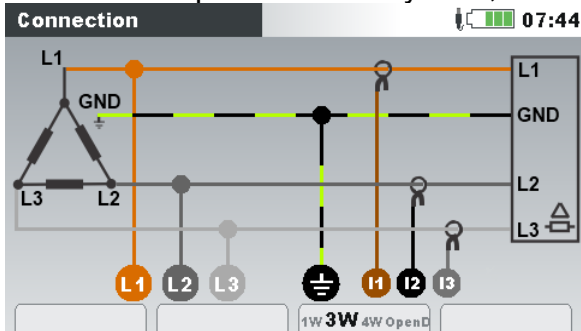

- **4W:** 3-phase 4-wire system;

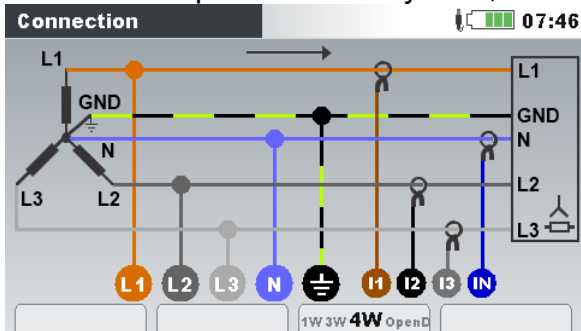

- **OpenD:** 3-phase 2 ½ -wire (Open Delta) system.

Connection

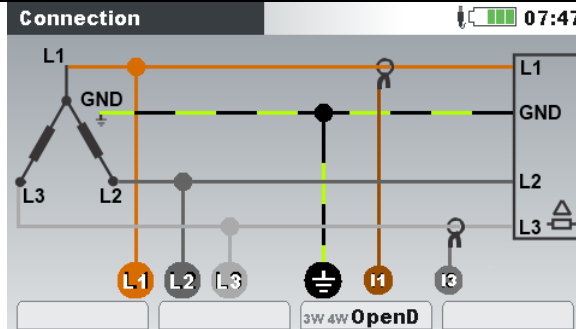

Synchronization

Synchronization channel. This channel is used for instrument synchronization to the network frequency. Also a frequency measurement is performed on that channel. Depending on **Connection** user can select:

- **1W**: U1 or I1.
- **3W, OpenD**: U12, or I1.
- **4W**: U1, I1.

System frequency

Select system frequency. According to this setting 10/12-cycle or 12 cycle interval will be used for calculus (according to IEC 61000-4-30):

- 50 Hz
- 60 Hz

Default parameters

Set factory default parameters. These are:

Nominal voltage: 230V (L-N);

Voltage ratio: 1:1;

$\Delta \leftrightarrow \blacktriangle$: 1

Phase current clamps: Smart Clamps;

Neutral current clamps: Smart Clamps;

Connection: 4W;

Synchronization: U1

System frequency: 50 Hz.

Dip voltage: 90% U_{Nom}

Interrupt voltage: 5% U_{Nom}

Swell voltage: 110% U_{Nom}

Clear alarm setup table

By pressing ENTER on Nominal Voltage menu, user can select additional parameters, such as Potential transformer voltage ratio.

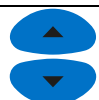

Table 3.75: Keys in Connection setup menu



Selects Connection setup parameter to be modified.



Changes selected parameter value.

	Enters into submenu. Confirms Factory reset.
	Returns to the “MEASUREMENT SETUP” submenu.

3.19.2 Event setup

In this menu user can setup voltage events and their parameters. See 5.1.11 for further details regarding measurement methods. Captured events can be observed through EVENTS TABLE screen. See 3.16 and 5.1.11 for details.

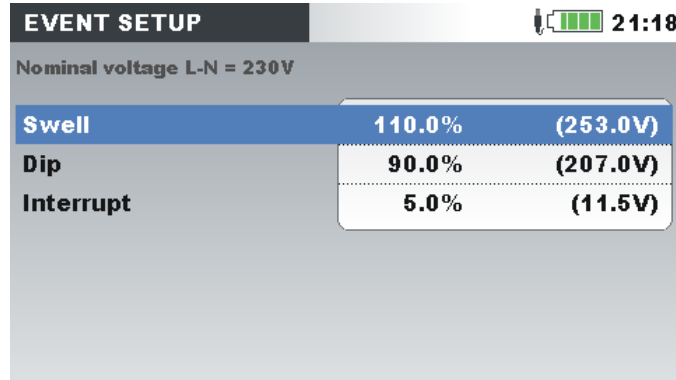





Figure 3.60: Event setup screen

Table 3.76: Description of Event setup

Nominal voltage	Indication of type (L-N or L-L) and value of nominal voltage.
Swell	Set swell threshold value.
Dip	Set dip threshold value.
Interrupt	Set interrupt threshold value.

Table 3.77: Keys in Event setup screen

	Selects Voltage events setup parameter to be modified.
	Changes selected parameter value.
	Returns to the “MEASUREMENT SETUP” submenu.

3.19.3 Alarm setup

Up to 10 different alarms, based on any measurement quantity which is measured by instrument, can be defined. See 5.1.12 for further details regarding measurement methods. Captured events can be observed through ALARMS TABLE screens. See 3.17 and 5.1.12 for details.

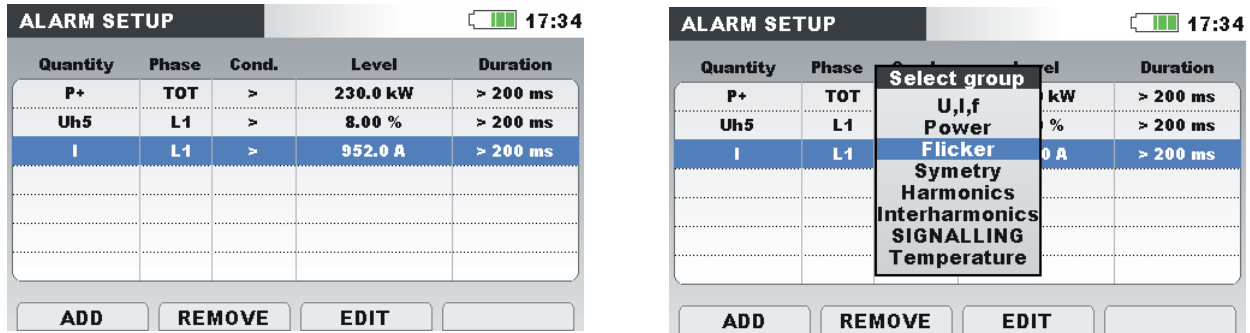



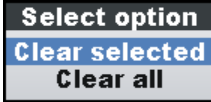





Figure 3.61: Alarm setup screens

Table 3.78: Description of Alarm setup

<p>1st column - Quantity (P+, Uh5, I, on figure above)</p>	<p>Select alarm from measurement group and then measurement itself.</p> <div style="display: flex; justify-content: space-around; align-items: center;"> <div data-bbox="518 779 694 996" style="border: 1px solid black; padding: 2px;"> <p style="background-color: #333; color: white; padding: 2px;">Select group</p> <p style="padding: 2px;">U,I,f Power</p> <p style="background-color: #007bff; color: white; padding: 2px;">Flicker</p> <p style="padding: 2px;">Symetry Harmonics Interharmonics SIGNALLING Temperature</p> </div> <div data-bbox="710 884 901 996" style="border: 1px solid black; padding: 2px;"> <p style="background-color: #333; color: white; padding: 2px;">Select quantity</p> <p style="background-color: #007bff; color: white; padding: 2px;">Pstmin</p> <p style="padding: 2px;">Pst PIt</p> </div> </div>
<p>2nd column - Phase (TOT, L1, on figure above)</p>	<p>Select phases for alarms capturing</p> <ul style="list-style-type: none"> • L1 – alarms on phase L₁; • L2 – alarms on phase L₂; • L3 – alarms on phase L₃; • LN – alarms on phase N; • L12 – alarms on line L₁₂; • L23 – alarms on line L₂₃; • L31 – alarm on line L₃₁; • ALL – alarms on any phase; • TOT – alarms on power totals or non-phase measurements (frequency, unbalance).
<p>3rd column - Condition (“>” on figure above)</p>	<p>Select triggering method: < trigger when measured quantity is lower than threshold (FALL); > trigger when measured quantity is higher than threshold (RISE);</p>
<p>4th column - Level</p>	<p>Threshold value.</p>
<p>5th column - Duration</p>	<p>Minimal alarm duration. Triggers only if threshold is crossed for a defined period of time.</p>
<p>Note: It is recommended that for flicker measurement, recorder is set to 10 min.</p>	

Table 3.79: Keys in Alarm setup screens

F1	ADD	Adds new alarm.
----	------------	-----------------

	REMOVE	Clears selected or all alarms:	
	EDIT	Edits selected alarm.	
		Enters or exits a submenu to set an alarm.	
		Cursor keys. Selects parameter or changes value.	
		Cursor keys. Selects parameter or changes value.	
		Confirms setting of an alarm. Returns to the "MEASUREMENT SETUP" submenu.	

3.19.4 Signalling setup

Mains signalling voltage, called "ripple control signal" in certain applications, is a burst of signals, often applied at a non-harmonic frequency, that remotely control industrial equipment, revenue meters, and other devices.

Two different signalling frequencies can be defined. Signals can be used as a source for the user defined alarm and can also be included in recording. See section 3.19.3 how to set-up alarms. See section 3.13 for instructions how to start recording.

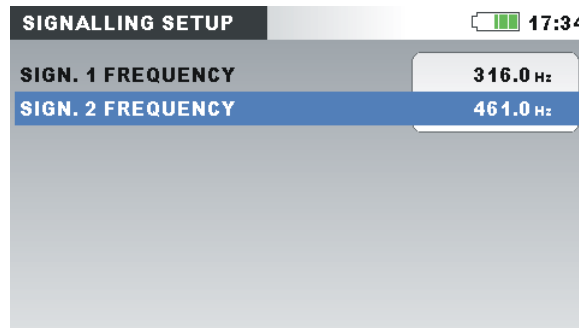





Figure 3.62: Signalling setup screen

Table 3.80: Keys in Signalling setup screen

	Toggles between Signal 1 and Signal 2.
	Changes selected signalling frequency value.
	Returns to the "MEASUREMENT SETUP" submenu.

3.20 General Setup submenu

From the "GENERAL SETUP" submenu communication parameters, real clock time, language can be reviewed, configured and saved.

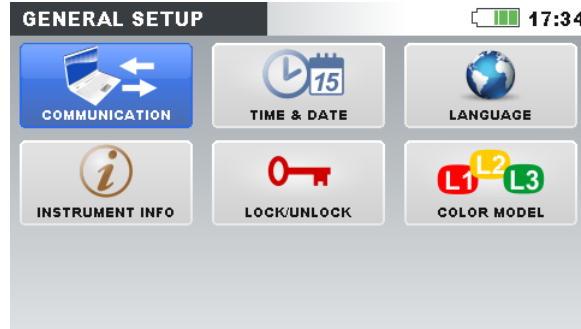

Figure 3.63: GENERAL SETUP submenu

Table 3.81: Description of General setup options

Communication	Setup communication source and baud rate.
Time & Date	Set time, date and time zone.
Language	Select language.
Instrument info	Information about the instrument.
Lock/Unlock	Lock instrument to prevent unauthorized access.
Colour Model	Select colours for displaying phase measurements.

Table 3.82: Keys in General setup submenu

	Selects option from the “GENERAL SETUP” submenu.
	Enters the selected option.
	Returns to the “MAIN MENU” screen.

3.20.1 Communication

RS 232, USB or INTERNET communication can be set in this menu.

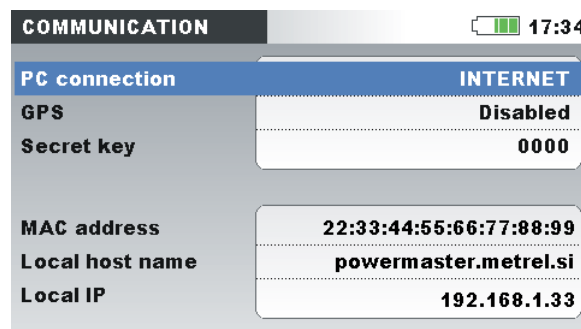





Figure 3.64: Communication setup screen

Table 3.83: Description of Communication setup options

PC connection	Select RS-232, USB or INTERNET communication port.
GPS	Enable GPS if used for time synchronisation.
Secret key	Valid only if INTERNET communication is selected. Secret number will assure additional protection of communication link. Same number should be entered in PowerView v3.0, before connection establishment.
MAC address	Instrument Ethernet MAC address.
Instrument host name	Instrument host name.
Instrument IP address	Instrument IP address.

Note: For more information regarding configuration, how to download data, view real time measuring data on PowerView and establish Remote instrument connection with PowerView over internet, RS-232 and USB communication interfaces, see section 4.3 and PowerView Instruction manual.

Table 3.84: Keys in Communication setup

	Changes communication source (RS – 232, USB, INTERNET) Enables/disables GPS. Moves cursor position during entering Secret key.
	Cursor keys. Selects parameter. Changes Secret key number.
	Enters Secret key edit window.
	Returns to the “GENERAL SETUP” submenu.



3.20.2 Time & Date

Time, date and time zone can be set in this menu.

3.20.3 Time & Date

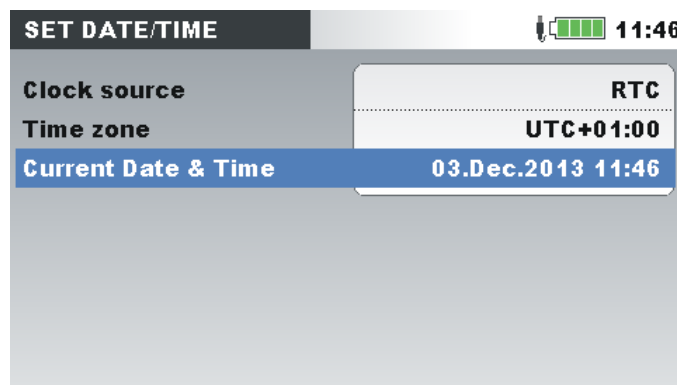

Figure 3.65: Set date/time screen

Table 3.85: Description of Set date/time screen





Clock source	<p>Show clock source: RTC – internal real time clock GPS – external GPS receiver Note: GPS clock source is automatically set if GPS is enabled and detected.</p>
Time zone	<p>Selects time zone. Note: Power Master has the ability to synchronize its system time clock with Coordinated Universal Time (UTC time) provided by externally connected GPS module. In that case only hours (time zone) should be adjusted. In order to use this functionality, see 4.2.5.</p>
Current Time & Date	<p>Show/edit current time and date (valid only if RTC is used as time source)</p> 

Table 3.86: Keys in Set date/time screen

	Selects parameter to be changed.
	Modifies parameter. Selects between the following parameters: hour, minute, second, day, month or year.
	Enters Date/time edit window.
	Returns to the “GENERAL SETUP” submenu.

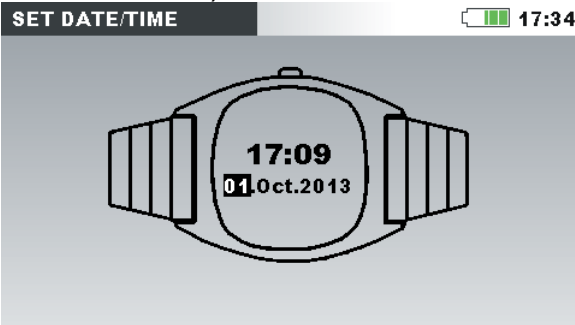
3.20.4 Language

Different languages can be selected in this menu.

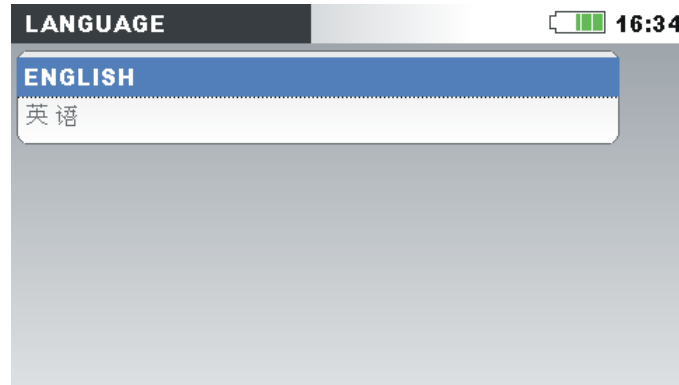





Figure 3.66: Language setup screen

Table 3.87: Keys in Language setup screen

	Selects language.
	Confirms the selected language.
	Returns to the “GENERAL SETUP” submenu.

3.20.5 Instrument info

Basic information concerning the instrument (company, user data, serial number, firmware version and hardware version) can be viewed in this menu.

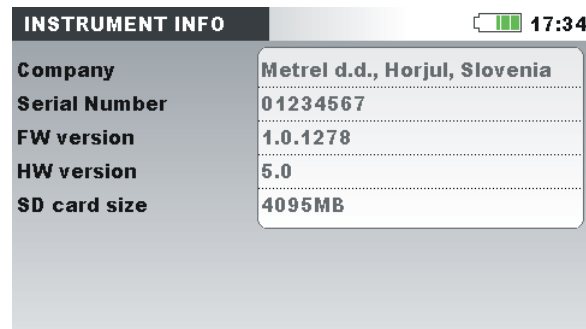

Figure 3.67: Instrument info screen

Table 3.88: Keys in Instrument info screen

	Returns to the “GENERAL SETUP” submenu.
---	---

3.20.6 Lock/Unlock

Power Master has the ability to prevent unauthorized access to all important instrument functionality by simply locking the instrument. If instrument is left for a longer period at an unsupervised measurement spot, it is recommended to prevent unintentional stopping of record, instrument or measurement setup modifications, etc. Although instrument lock prevents unauthorized changing of instrument working mode, it does not prevent non-destructive operations as displaying current measurement values or trends. User locks the instrument by entering secret lock code in the Lock/Unlock screen.

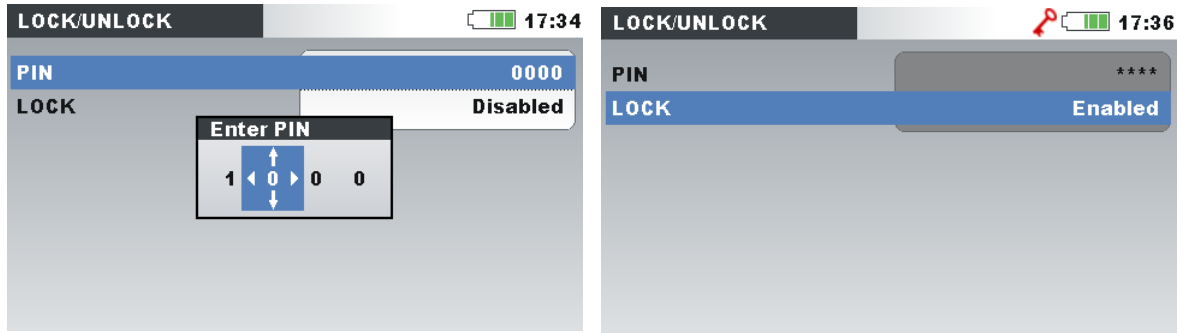





Figure 3.68: Lock/Unlock screen

Table 3.89: Description of Lock/Unlock screen

Pin	<p>Four digit numeric code used for Locking/Unlocking the instrument. Press ENTER key for changing the Pin code. “Enter PIN” window will appear on screen.</p> <p>Note: Pin code is hidden (****), if the instrument is locked. The following options for locking the instrument are available:</p> <ul style="list-style-type: none"> • Disabled • Enabled
Lock	

Table 3.90: Keys in Lock/Unlock screen

	<p>Selects parameter to be modified. Change value of the selected digit in Enter pin window.</p>
	<p>Selects digit in Enter pin window. Locks the instrument. Opens Enter pin window for unlocking.</p>
	<p>Opens Enter pin window for pin modification. Accepts new pin. Unlocks the instrument (if pin code is correct).</p>
	<p>Returns to the “GENERAL SETUP” submenu.</p>

Following table shows how locking impacts instrument functionality.

Table 3.91: Locked instrument functionality

MEASUREMENTS	<p>Allowed access. Waveform snapshot functionality is blocked.</p>
RECORDERS	No access.
MEASUREMENT SETUP	No access.
GENERAL SETUP	No access except to Lock/Unlock menu.

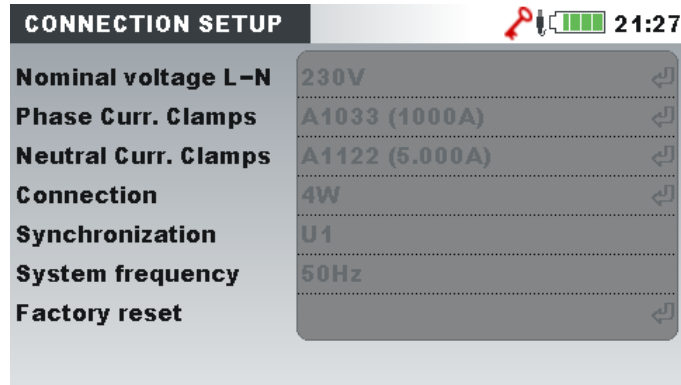

Figure 3.69: Locked instrument screen

Note: In case user forget unlock code, general unlock code “7350” can be used to unlock the instrument.

3.20.7 Colour model

In COLOUR MODEL menu, user can change colour representation of phase voltages and currents, according to the customer needs. There are some predefined colour schemes (EU, USA, etc.) and a custom mode where user can set up its own colour model.

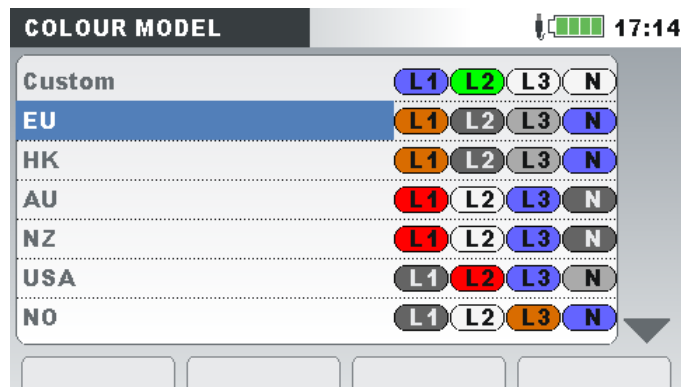
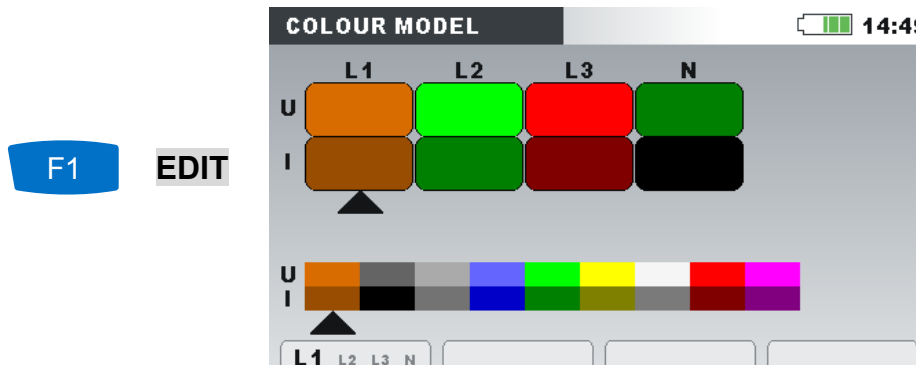



Figure 3.70: Colour representation of phase voltages

Table 3.92: Keys in Colour model screens

Opens edit colour screen (only available in custom model).



Keys in Edit colour screen:

	L1 L2 L3 N	Shows selected colour for phase L1.
	L1 L2 L3 N	Shows selected colour for phase L2.
	L1 L2 L3 N	Shows selected colour for phase L3.
	L1 L2 L3 N	Shows selected colour for neutral channel N.

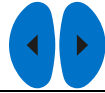

Selects colour.



Returns to the “COLOUR MODEL” screen.

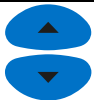

Selects Colour scheme.



Confirms selection of Colour scheme and returns to the “GENERAL SETUP” submenu.



Returns to the “GENERAL SETUP” submenu without modifications.

4 Recording Practice and Instrument Connection

In following section recommended measurement and recording practice is described.

4.1 Measurement campaign

Power quality measurements are specific type of measurements, which can last many days, and mostly they are *performed* only once. Usually recording campaign is performed to:

- Statistically analyse some points in the network.
- Troubleshoot malfunctioning device or machine.

Since measurements are mostly *performed* only once, it is very important to properly set measuring equipment. Measuring with wrong settings can lead to false or useless measurement results. Therefore instrument and user should be fully prepared before measurement begins.

In this section recommended recorder procedure is shown. We recommend to strictly follow guidelines in order to avoid common problems and measurement mistakes. Figure below shortly summarizes recommended measurement practice. Each step is then described in details.

Note: PC software PowerView v3.0 has the ability to correct (after measurement is done):

- wrong real-time settings,
- wrong current and voltage scaling factors.

False instrument connection (messed wiring, opposite clamp direction), can't be fixed afterwards.

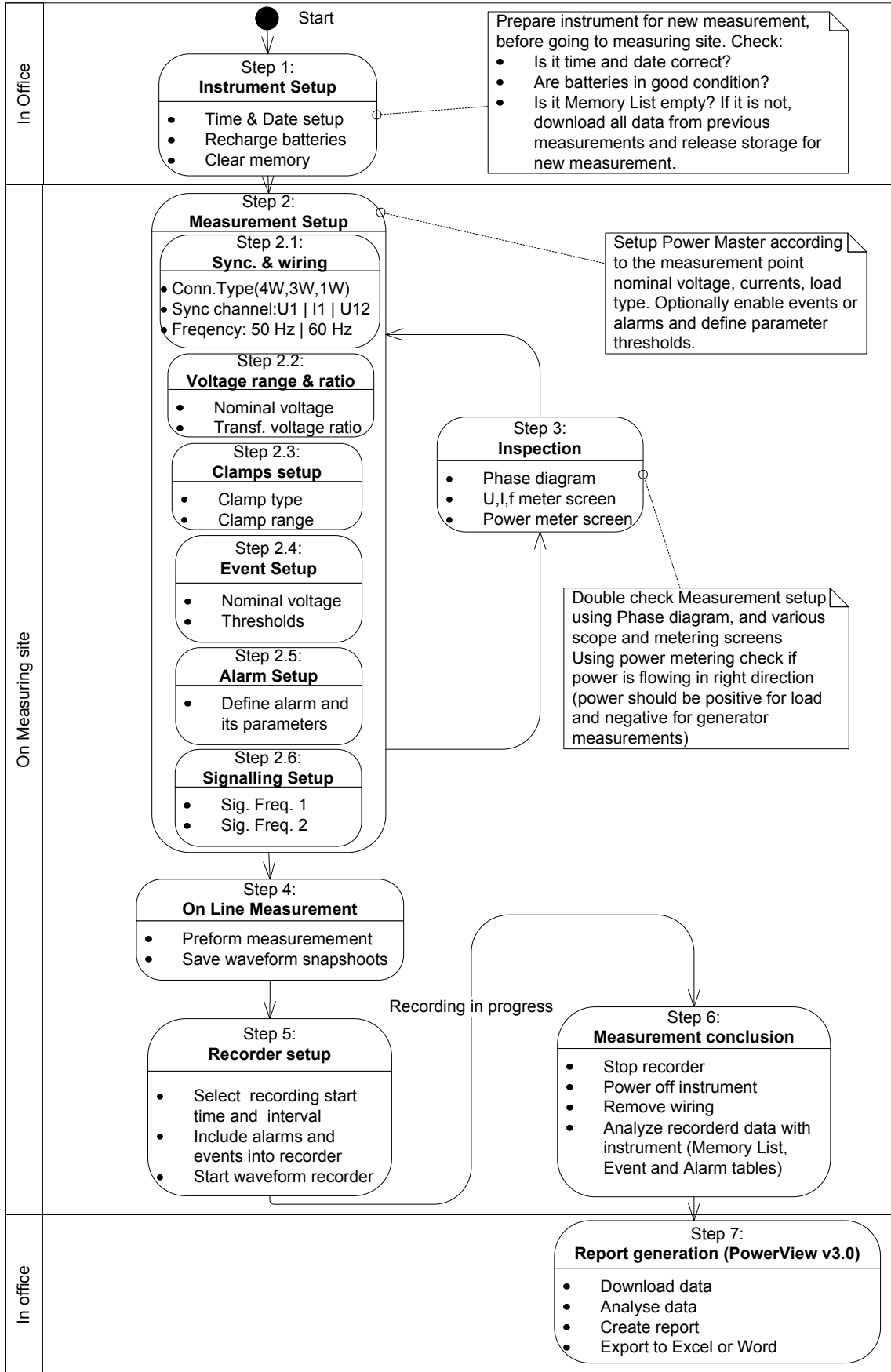

Figure 4.1: Recommended measurement practice

Step 1: Instrument setup

On site measurements can be very stressful, and therefore it is good practice to prepare measurement equipment in an office. Preparation of Power Master include following steps:

- Visually check instrument and accessories.
Warning: Don't use visually damaged equipment!
- Always use batteries that are in good condition and fully charge them before you leave an office.
Note: In problematic PQ environment where dips and interrupts frequently occurs instrument power supply fully depends on batteries! Keep your batteries in good condition.
- Download all previous records from instrument and clear the memory. (See section 3.18 for instruction regarding memory clearing).
- Set instrument time and date. (See section 3.20.2 for instruction regarding time and date settings).

Step 2: Measurement setup

Measurement setup adjustment is *performed* on measured site, after we find out details regarding nominal voltage, currents, type of wiring etc.

Step 2.1: Synchronization and wiring

- Connect current clamps and voltage tips to the "Device under measurement" (See section 4.2 for details).
- Select proper type of connection in "Connection setup" menu (See section 3.19.1 for details).
- Select synchronization channel. Synchronization to voltage is recommended, unless measurement is performed on highly distorted loads, such as PWM drives. In that case current synchronization can be more appropriate. (See section 3.19.1 for details).
- Select System frequency. System frequency is default mains system frequency. Setting this parameter is recommended if to measure signalling or flickers.

Step 2.2: Nominal voltage and ratio

- Select instrument nominal voltage according to the network nominal voltage.
Note: For 4W and 1W measurement all voltages are specified as phase-to-neutral (L-N). For 3W and Open Delta measurements all voltages are specifies as phase-to-phase (L-L).
Note: Instrument assures proper measurement up to 150 % of chosen nominal voltage.
- In case of indirect voltage measurement, select appropriate "Voltage ratio" parameters, according to transducer ratio. (See section 3.19.1 and 4.2.2 for details).

Step 2.3: Current clamps setup

- Using “Select Clamps” menu, select proper Phase and Neutral channel current clamps (see sections 3.19.1 for details).
- Select proper clamps parameters according to the type of connection (see section 4.2.3 for details).

Step 2.4: Event setup

Select threshold values for: swell, dip and interrupts (see sections 3.19.2 and 3.16 for details).

Note: You can also trigger WAVEFORM RECORDER on events. Instrument will then capture waveform and inrush for each event.

Step 2.5: Alarm setup

Use this step if you would like only to check if some quantities crosses some predefined boundaries (see sections 3.17 and 3.19.3 for details).

Note: You can also trigger WAVEFORM RECORDER on alarms. Instrument will then capture waveform and inrush for each alarm.

Step 2.6: Signalling setup

Use this step only if you are interested in measuring mains signalling voltage. See section 3.19.4 for details.

Step 3: Inspection

After setup instrument and measurement is finished, user need to re-check if everything is connected and configured properly. Following steps are recommended:

- Using PHASE DIAGRAM menu check if voltage and current phase sequence is right regarding to the system. Additionally check if current has right direction.
- Using U, I, f menu check if voltage and current have proper values.
- Check voltage and current THD.

Note: Excessive THD can indicate that too small range was chosen!

Note: In case of AD converter overvoltage or overloading current, icon  will be displayed.

- Using POWER menu check signs and indices of active, nonactive, apparrant power and power factor.

If any of these steps give you suspicious measurement results, return to Step 2 and double check measurement setup parameters.

Step 4: On-line measurement

Instrument is now ready for measurement. Observe on line parameters of voltage, current, power, harmonics, etc. according to the measurement protocol or customer demands.

Note: Use waveform snapshots  to capture important measurement. Waveform snapshot capture all power quality signatures at once (voltage, current, power, harmonics, flickers).

Step 5: Recorder setup and recording

Using GENERAL RECORDER menu select type of recording and configure recording parameters such as:

- Time **Interval** for data aggregation (Integration Period)
- Include events and alarms capture if necessary
- Recording start time (optional)
- After setting recorder, recording can be started. (see section 3.13 for recorder details). Additionally user can start WAVEFORM RECORDER if you want to get waveform for each captured alarm or event.

Note: Available memory status in Recorder setup should be checked before starting recording. Max. recording duration and max. number of records are automatically calculated according to recorder setup and memory size.

Note: Recording usually last few days. Assure that instrument during recording session is not reachable to the unauthorized persons. If necessary use LOCK functionality described in section 3.20.6.

Step 6: Measurement conclusion

Before leaving measurement site we need to:

- Preliminary evaluate recorded data using TREND screens.
- Stop recorder.
- Assure that we record and measure everything we needed.

Step 7: Report generation (PowerView v3.0)

Download records using PC software PowerView v3.0 perform analysis and create reports. See PowerView v3.0 manual for details.

4.2 Connection setup

4.2.1 Connection to the LV Power Systems

This instrument can be connected to the 3-phase and single phase network.

The actual connection scheme has to be defined in CONNECTION SETUP menu (see Figure below).

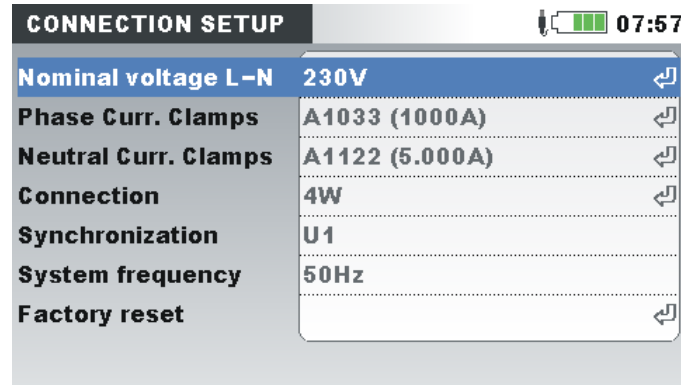

Figure 4.2: Connection setup menu

When connecting the instrument it is essential that both current and voltage connections are correct. In particular the following rules have to be observed:

Clamp-on current clamp-on transformers

- The arrow marked on the clamp-on current transformer should point in the direction of current flow, from supply to load.
- If the clamp-on current transformer is connected in reverse the measured power in that phase would normally appear negative.

Phase relationships

- The clamp-on current transformer connected to current input connector I_1 has to measure the current in the phase line to which the voltage probe from L_1 is connected.

3-phase 4-wire system

In order to select this connection scheme, choose following connection on the instrument:

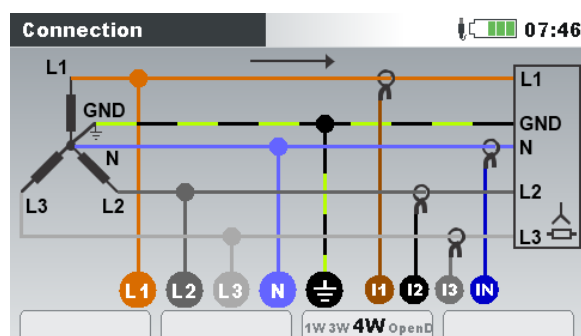

Figure 4.3: Choosing 3-phase 4-wire system on instrument

Instrument should be connected to the network according to figure below:

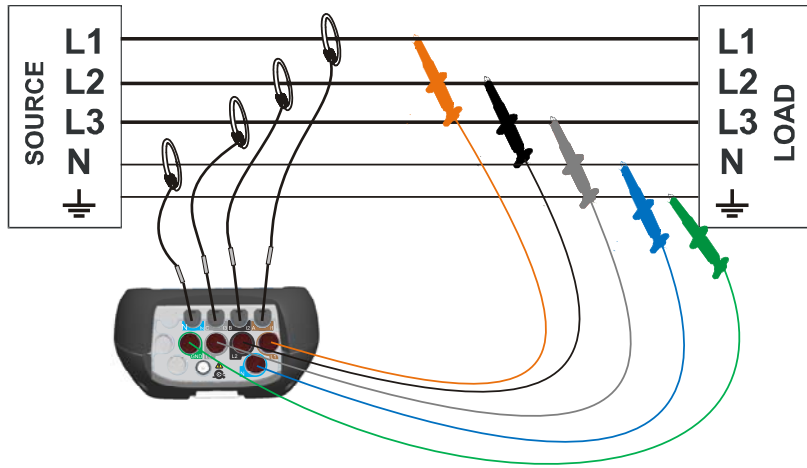

Figure 4.4: 3-phase 4-wire system

3-phase 3-wire system

In order to select this connection scheme, choose following connection on the instrument:

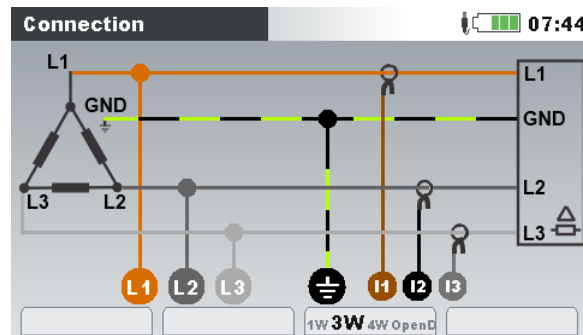

Figure 4.5: Choosing 3-phase 3-wire system on instrument

Instrument should be connected to the network according to figure below.

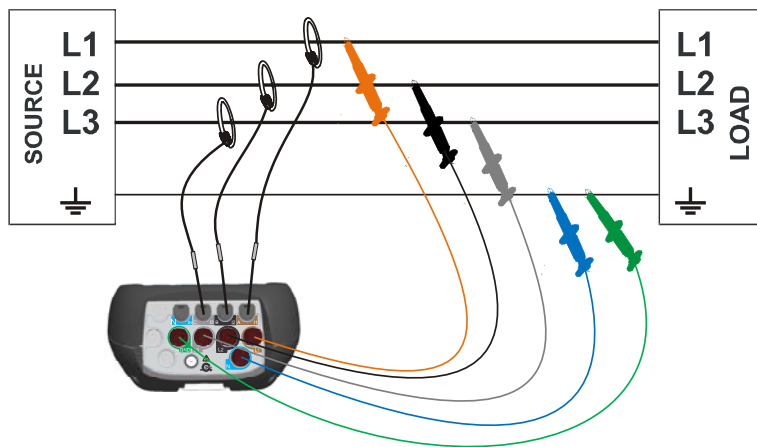

Figure 4.6: 3-phase 3-wire system

Open Delta (Aaron) 3-wire system

In order to select this connection scheme, choose following connection on the instrument:

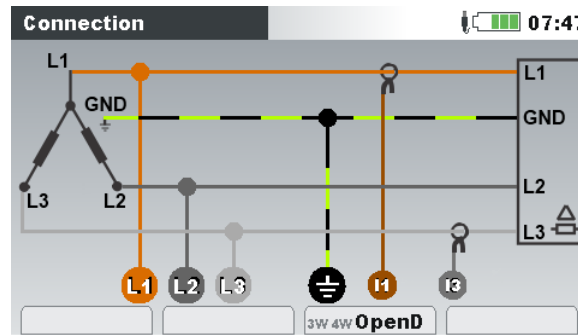

Figure 4.7: Choosing Open Delta (Aaron) 3-wire system on instrument

Instrument should be connected to the network according to figure below.

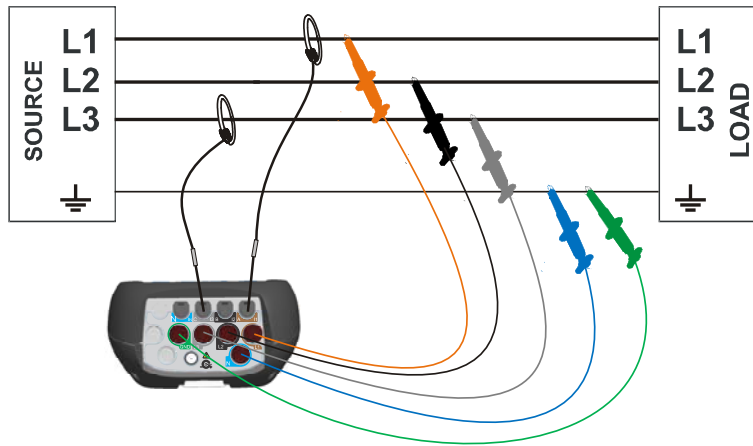

Figure 4.8: Open Delta (Aaron) 3-wire system

1-phase 3-wire system

In order to select this connection scheme, choose following connection on the instrument:

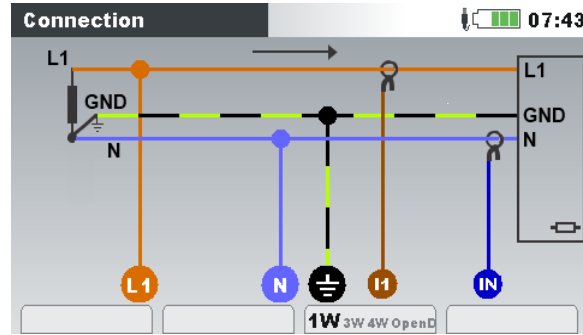

Figure 4.9: Choosing 1-phase 3-wire system on instrument

Instrument should be connected to the network according to figure below.

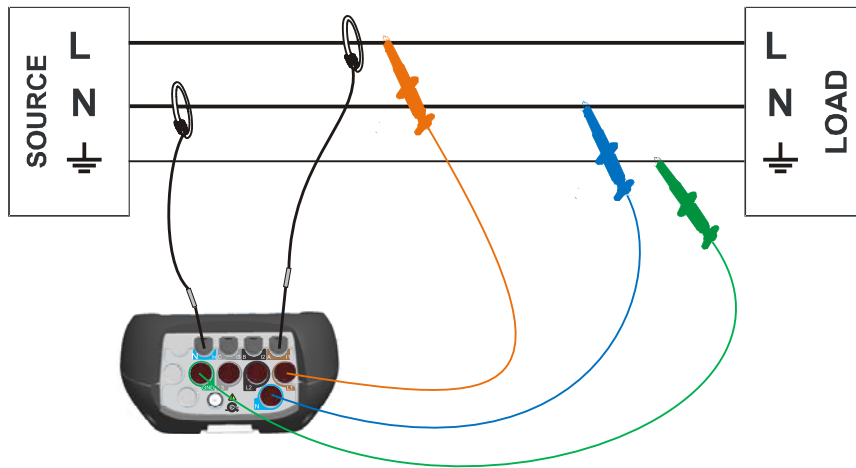

Figure 4.10: 1-phase 3-wire system

Note: In case of events capturing, it is recommended to connect unused voltage inputs to N voltage input.

4.2.2 Connection to the MV or HV Power System

In systems where voltage is measured at the secondary side of a voltage transformer (say 11 kV / 110 V), the voltage transformer ratio should be entered first. Afterward nominal voltage can be set to ensure correct measurement. In the next figure settings for this particular example is shown. See 3.19.1 for details.

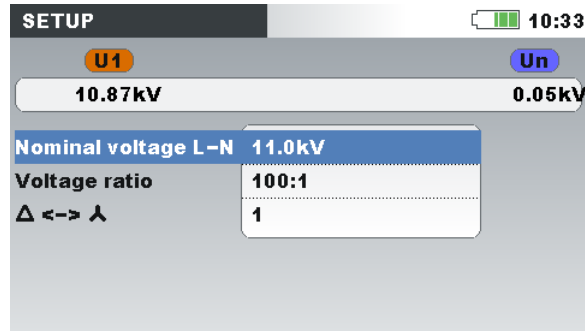

Figure 4.11: Voltage ratio for 11 kV / 110 kV transformer example

Instrument should be connected to the network according to figure below.

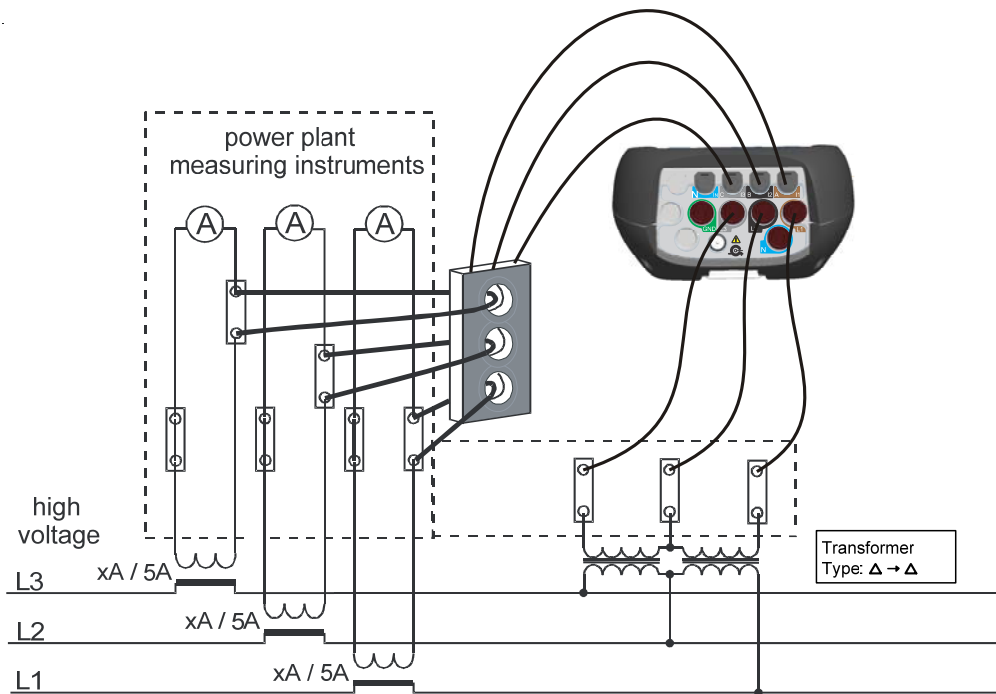

Figure 4.12: Connecting instrument to the existing current transformers in medium voltage system

4.2.3 Current clamp selection and transformation ratio setting

Clamp selection can be explained by two typical use cases: **direct current measurement** and **indirect current measurement**. In next section recommended practice for both cases is shown.

Direct current measurement with clamp-on current transformer

In this type of measurement load/generator current is measured directly with one of clamp-on current transformer. Current to voltage conversion is *performed directly* by the clamps.

Direct current measurement can be *performed* by any clamp-on current transformer. We particularly recommend Smart clamps: flex clamps A1227 and iron clamps A1281. Also other Metrel clamp models A1033 (1000 A), A1069 (100 A), A1120 (3000 A), A1099 (3000 A), etc. can be used.

In the case of large loads there can be few parallel feeders which can't be embraced by single clamps. In this case we can measure current only through one feeder as shown on figure below.

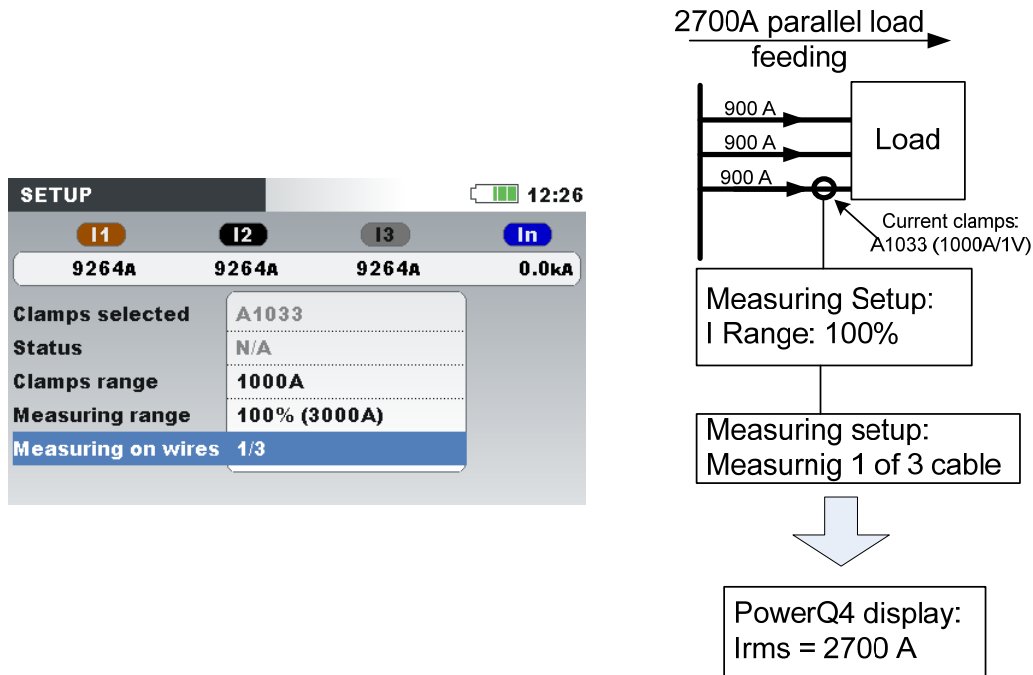

Figure 4.13: Parallel feeding of large load

Example: 2700 A current load is fed by 3 equal parallel cables. In order to measure current we can embrace only one cable with clamps, and select: Measuring on wires: 1/3 in clamp menu. Instrument will assume that we measure only third part of current.

Note: During setup current range can be observed by “Current range: 100% (3000 A)” row.

Indirect current measurement

Indirect current measurement with primary current transducer is assumed if user selects 5 A current clamps: A1122 or A1037. Load current is in that case measured **indirectly** through additional primary current transformer.

In **example** below we have 100 A of primary current flowing through primary transformer with ratio 600 A : 5 A. Settings are shown in following figure.

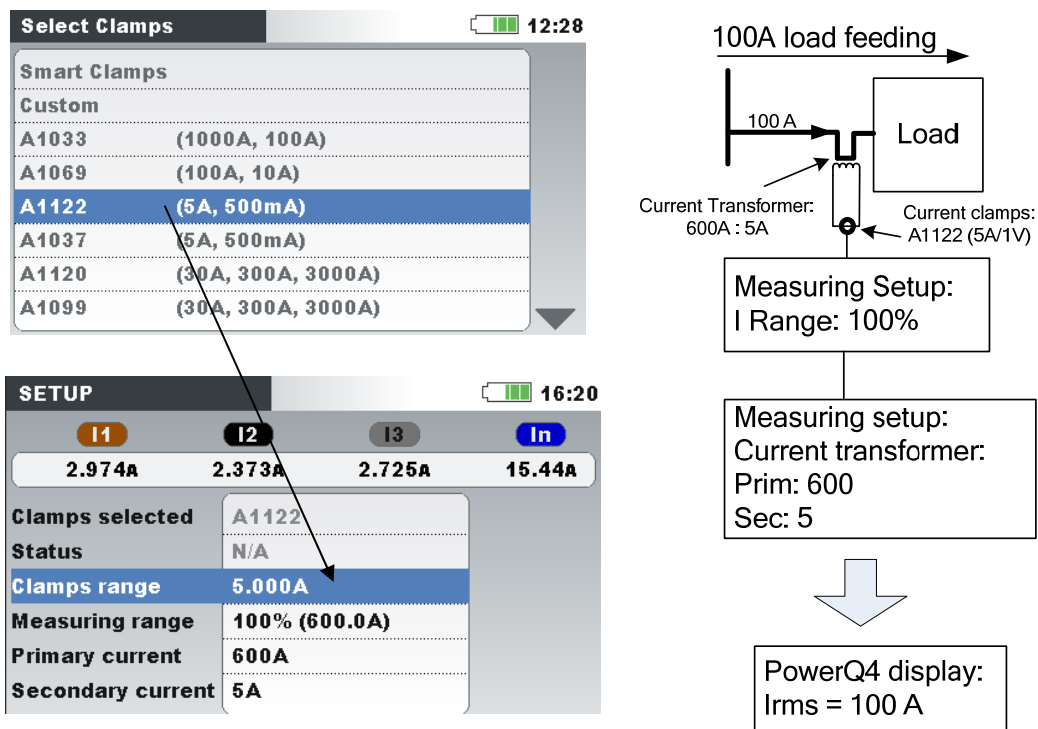

Figure 4.14: Current clamps selection for indirect current measurement

Over-dimensioned current transformer

Installed current transformers on the field are usually over-dimensioned for “possibility to add new loads in future”. In that case current in primary transformer can be less than 10% of rated transformer current. For such cases it is recommended to select 10% current range as shown on figure below.

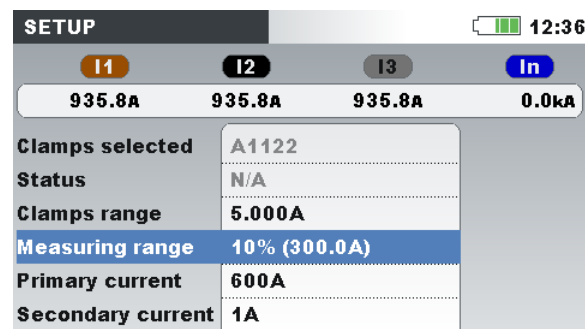

Figure 4.15: Selecting 10% of current clamps range

Note that if we want to perform direct current measure with 5 A clamps, primary transformer ratio should be set to 5 A : 5 A.

⚠ WARNINGS !

- The secondary winding of a current transformer must not be open when it is on a live circuit.
- An open secondary circuit can result in dangerously high voltage across the terminals.

Automatic current clamps recognition

Metrel developed Smart current clamps product family in order to simplify current clamps selection and settings. Smart clamps are multi-range switch-less current clamps automatically recognized by instrument. In order to activate smart clamp recognition, the following procedure should be followed for the first time:

1. Turn on the instrument
2. Connect clamps (for example A 1227) to Power Master
3. Enter: Measurement Setup → Connection setup → Phase/Neutral Curr. Clamps menu
4. Select: Smart clamps
5. Clamps type will be automatically recognized by the instrument.
6. User should then select clamp range and confirm settings.

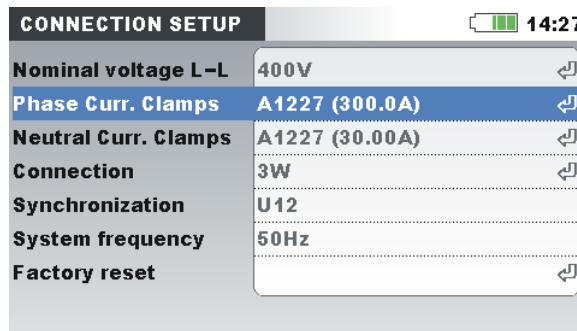

Figure 4.16: Automatically recognised clamps setup

Instrument will remember clamps setting for the next time. Therefore, user only need to:

1. Plug clamps to the instrument current input terminals
2. Turn on the instrument

Instrument will recognize clamps automatically and set ranges as was settled on measurement before. If clamps were disconnected following pop up will appear on the screen (See Figure below). Use cursor keys to select Smart clamp current range.

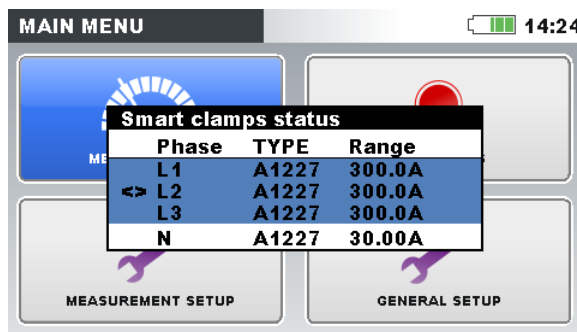



Figure 4.17: Automatically recognised clamps status

Table 4.1: Keys in Smart clamps pop up window

	Changes Clamps current range.
	Selects Phase or Neutral current clamps.



Confirms selected range and returns to previous menu.

Clamps Status menu indicates that there is an inconsistency between current clamps defined in Clamps Setup menu and clamps present at the moment.

Note: Do not disconnect smart clamps during recording.

4.2.4 Temperature probe connection

Temperature measurement is performed using smart temperature probe connected to the neutral current input channel IN. In order to activate smart clamp recognition, following procedure should be followed for the first time:

1. Turn on the instrument
2. Connect temperature probe to Power Master neutral current input terminal
3. Enter: Measurement setup → Connection setup → Neutral curr. clamps
4. Select: Smart clamps
5. Temperature probe will now be automatically recognized by the instrument.

Instrument will remember settings for the next time. Therefore, user only needs to plug temperature probe to the instrument.

4.2.5 GPS time synchronization device connection

Power Master has the ability to synchronize its system time clock with Coordinated Universal Time (UTC time) provided by externally connected GPS module (optional accessory - A 1355). In order to be able to use this particular functionality, GPS should be enabled in COMMUNICATION MENU. See 3.20.1 for details. Once this is done, GPS module can be attached to the PS/2 communication port. Power Master distinguishes two different states regarding GPS module functionality.

Table 4.2: GPS functionality

	GPS module detected, position not valid or no satellite GPS signal reception.
	GPS module detected, satellite GPS signal reception, date and time valid and synchronized, synchronization pulses active

Once an initial position fix is obtained, instrument will set time and date to GPS + Time zone - user selected in Set Date/Time menu (*see figure below*).

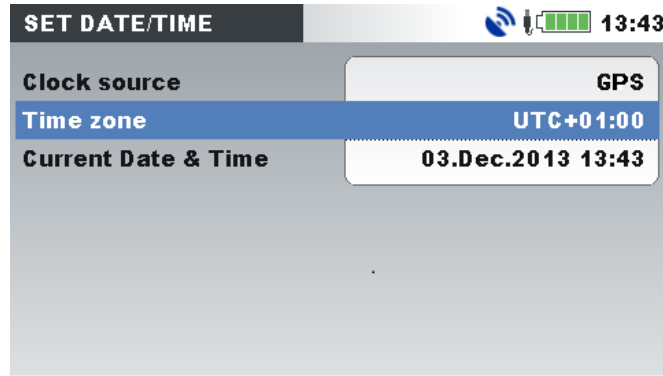



Figure 4.18: Set time zone screen

Table 4.3: Keys in Set time zone screen

	Changes Time zone.
	Confirm selected Time zone and returns to “GENERAL SETUP” menu.

When the time zone is set, Power Master will synchronize its system time clock and internal RTC clock with the received UTC time. GPS module also provides the instrument with extremely accurate synchronization pulses every second (PPS – Pulse Per Second) for synchronization purposes in case of lost satellite reception.

Note: GPS synchronization should be done before starting measurements.

For detailed information please check user manual of A 1355 GPS Receiver.

4.3 Remote instrument connection (over Internet)

4.3.1 Communication principle

Power Master instrument use Ethernet for connection to PowerView through internet. As companies frequently use firewalls to limit internet traffic options, whole communication is routed through dedicated “Metrel Server”. In this way instrument and PowerView can avoid firewalls and router restrictions. Communication is established in four steps:

1. User enters instrument communication parameter (on remote site), and check if connection to Metrel server can be established (status bar icon .
2. User enters communication parameters on PowerView (on local site) and connect to Metrel server.
3. Instrument connects to PowerView through Metrel server.

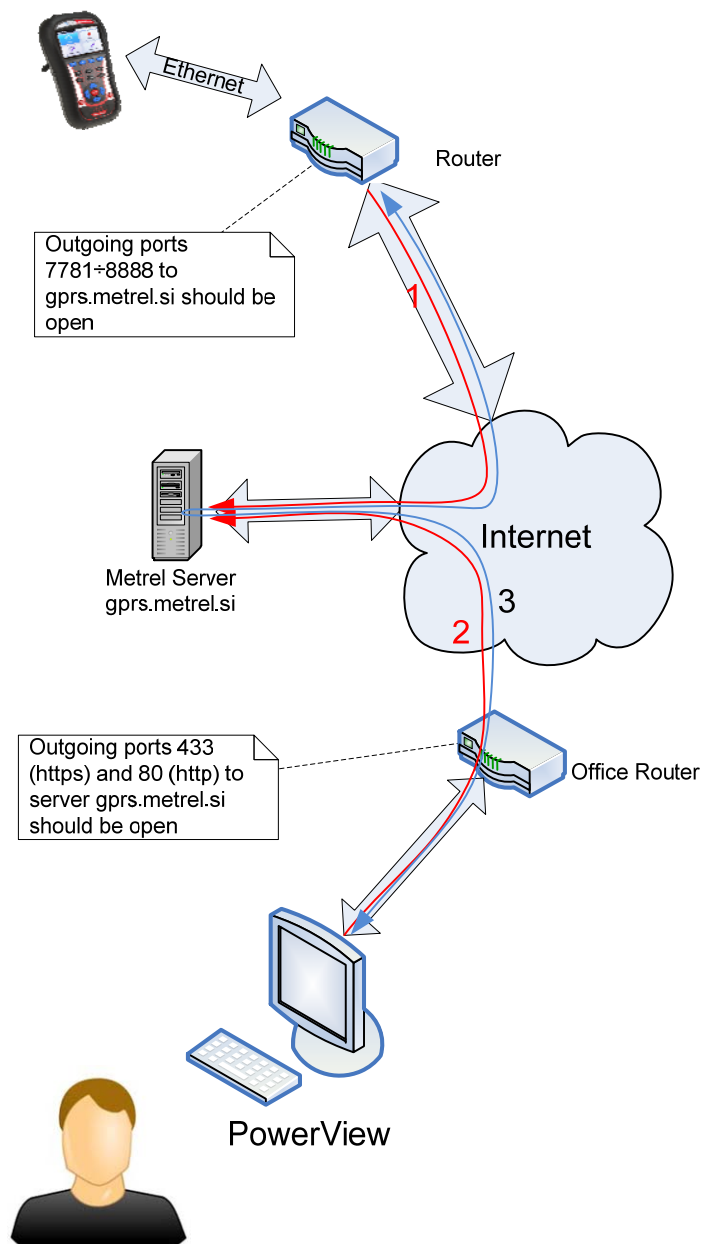

Figure 4.19: Schematic view on the remote measurements

4.3.2 Instrument setup on remote measurement site

Installation procedure on remote site starts by connecting Power Master instrument to the grid or measurement point. As measurement campaign can last for days or weeks it is necessary to assure reliable power supply to the instrument. Additionally fully charged instrument batteries can provide power to the instrument during interrupts and blackouts for more than 5 hours. After instrument installation, connection parameters should be set.

In order to establish remote connection with instrument through PC software PowerView v3.0, instrument communication parameters should be configured. Figure below shows COMMUNICATION menu in GENERAL SETUP.

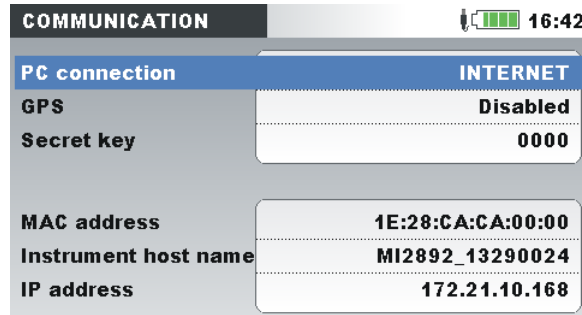



Figure 4.20: Internet connection setup screen

Following parameters should be entered in order to establish Internet communication:



Table 4.4: Internet setup parameters

PC connection	Internet	Select internet connection in order to communicate with PowerView over internet connection.
Secret key	0000	Enter number code (4-digits). User need to store this number, as will be later asked by PowerView v3.0, during connection procedure

After entering parameters user should connect Ethernet cable. Instrument will receive IP address from DHCP Server. It can take up to 2 minutes in order to get new IP number. Once instrument IP address is obtained, it will try to connect to Metrel server, over which communication with PowerView is assured. Once everything is connected,  icon will appear on the Status bar.

Connection status can be also observed on instrument Status bar, as shown on table below.

Table 4.5: Internet status bar icons

	Internet connection is not available. Instrument is trying to obtain IP address and then connect to Metrel server.
	Instrument is connected to the internet and Metrel server, and ready for communication.
	Instrument is connected to the PowerView.

4.3.3 PowerView setup for instrument remote access

In order to access remotely to the instrument, PC software PowerView v3.0 should be configured properly (See PowerView v3.0 manual for instructions how to install to your PC). PowerView v3.0 communicates over 80 and 443 ports, on similar way as your internet browser.

PowerView settings

Press on Remote  Remote in toolbar in order to open remote connection settings, as shown on figure below.

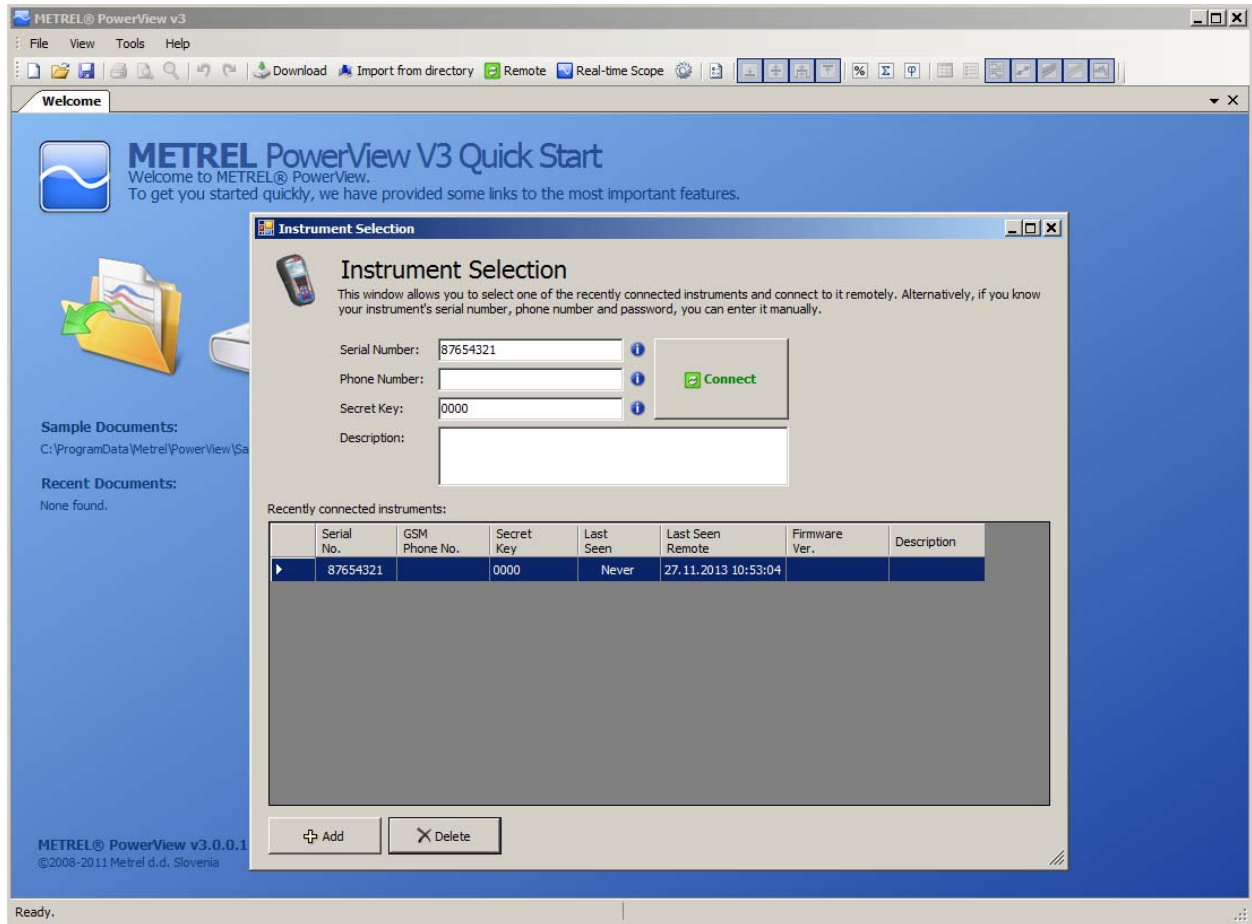



Figure 4.21: PowerView v3.0 remote connection settings form

User need to fill following data into form:

Table 4.6: Instrument selection form parameters

Serial Number:	Required	Enter Power Master serial number
Phone Number:	Not Required	Leave this field empty
Secret Key:	Required	Enter number code which was entered in instrument Communication settings menu as: Secret Key .
Description:	Optional	Enter instrument description

By pressing **+Add** button, user can add another instrument configuration. **X Delete** button is used to remove selected instrument configuration from the list. Connection procedure will begin, by pressing on  **Connect** button.

4.3.4 Remote connection

Establishing connection

After entering PowerView v3.0 remote settings and pressing on **Connect** button, Remote Connection window will appear (shown below).

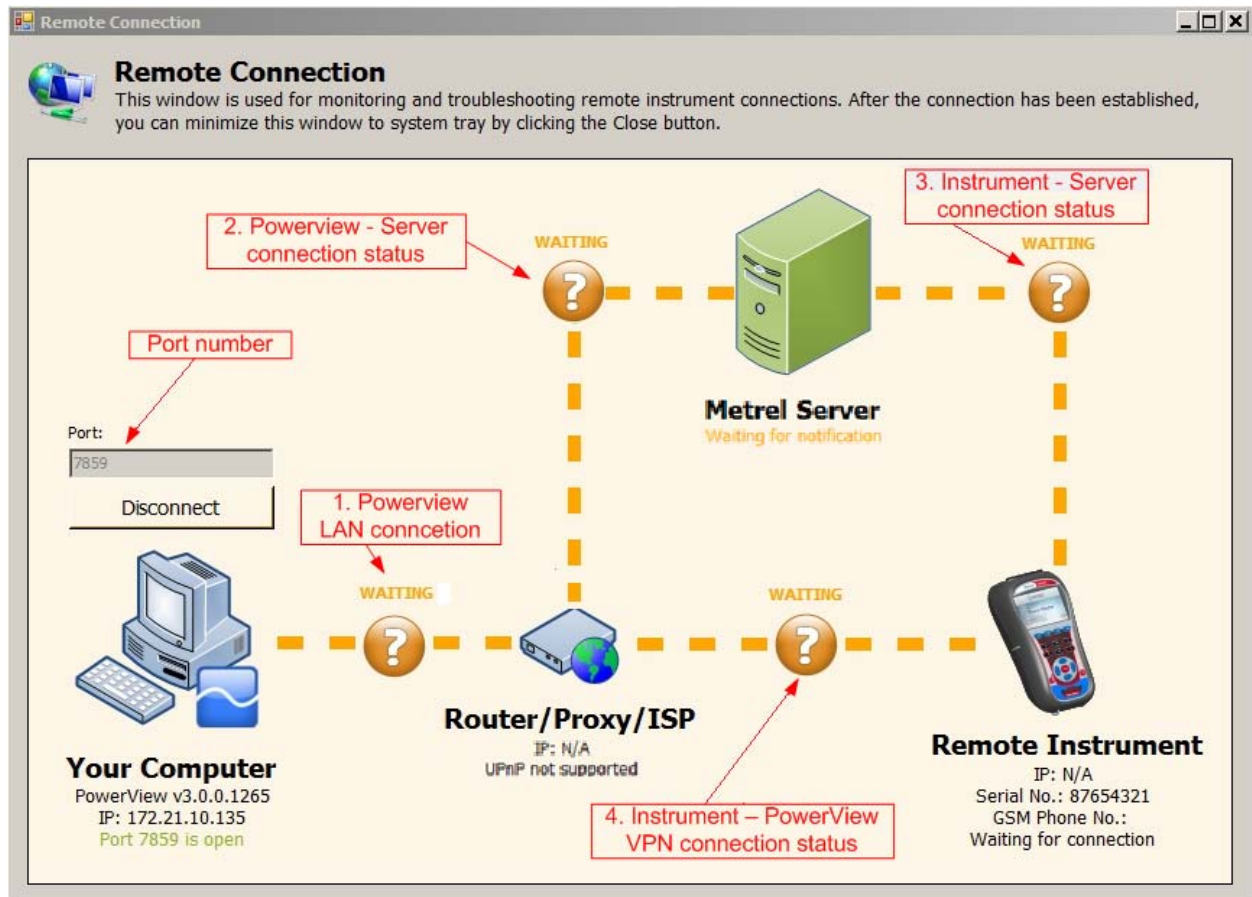

Figure 4.22: PowerView v3.0 remote connection monitor

This window is used for monitoring and troubleshooting remote instrument connection. Remote connection can be divided into 4 steps.

Step 1: PowerView v3.0 connection to Local Area Network (LAN)

After entering "Remote Connection" PowerView v3.0 will try to establish internet connection automatically. In order to establish connection, PowerView v3.0 requires http connection to the internet. If connection was successful, a green icon and "CONNECTED" status will appear between "Your Computer" and "Router/Proxy/ISP" icons, as shown on figure below. In case of ERROR, please ask your network administrator to provide PowerView v3.0 http access to the internet.

Step 2: PowerView v3.0 connection to Metrel Server

After establishing internet connection in Step 1, PowerView v3.0 will contact Metrel Server. If connection was successful, a green icon and "CONNECTED" status will appear between "Metrel Server" and "Router/Proxy/ISP" icons, as shown on figure below. In case of ERROR, please ask your network administrator for help. Note that outgoing communication to gprs.metrel.si over 80 and 443 ports should be enabled.

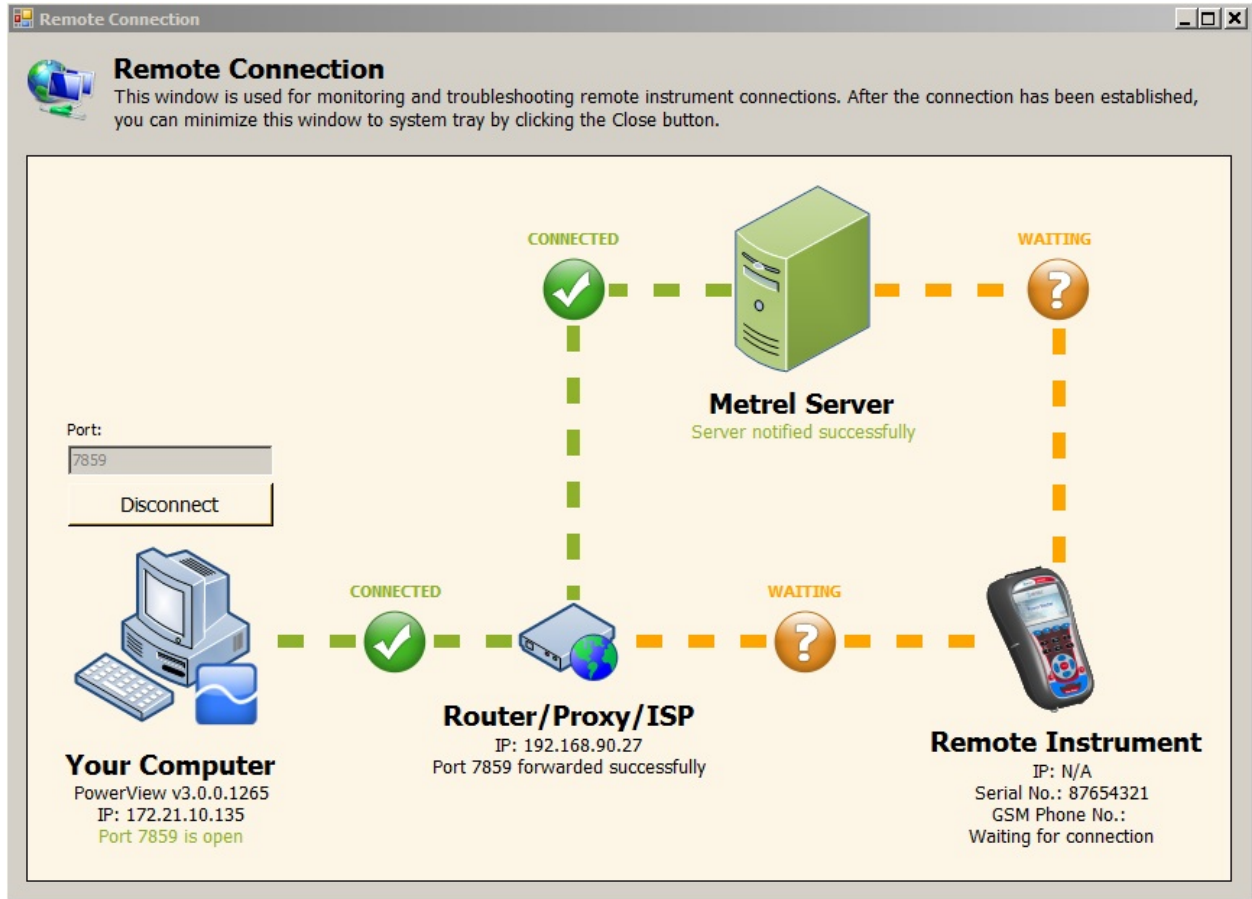

Figure 4.23: PowerView connection to LAN and Metrel Server established (Steps 1 & 2)

Note: Step 1 and Step 2 are automatically executed, after entering Remote Connection.

Step 3: Remote Instrument connection to Metrel Server

After the PowerView v3.0 successful connects to the Metrel Server, server will check if your instrument is waiting for your connection. If that is a case, instrument will establish connection with Metrel server. The green icon and “CONNECTED” status will appear between “Metrel Server” and “Remote Instrument” icon, as shown on figure below.

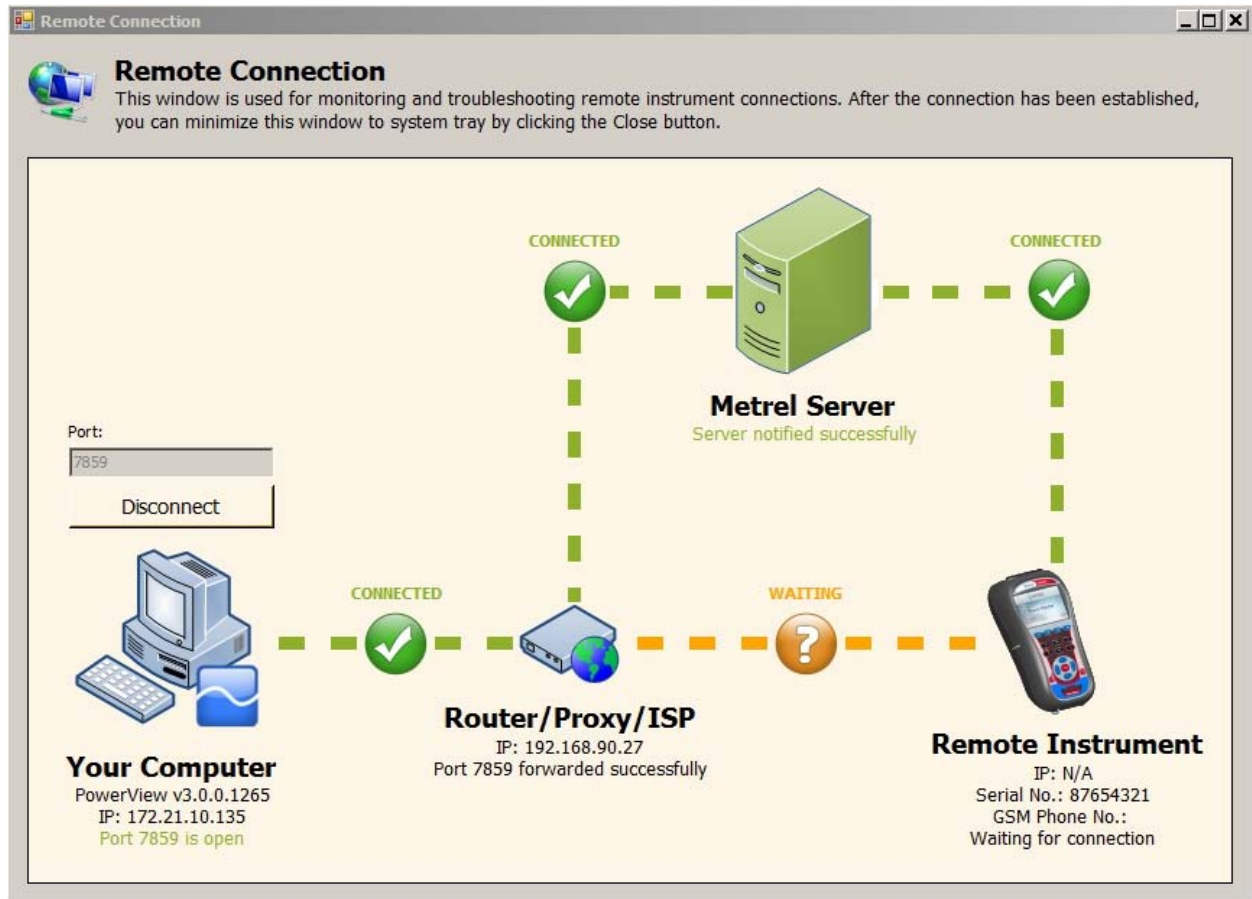

Figure 4.24: Remote instrument connection to Metrel Server established (Step 3)

Step 4: Remote Instrument connection to PowerView v3.0

After first three steps were successfully finished, Power Master instrument will automatically connect to the PowerView v3.0 via VPN connection, made through Metrel server and establish connection.

If Remote Instrument connection to PowerView v3.0 was successful, a green icon and "CONNECTED" status will appear between "Router/Proxy/ISP" and "Remote Instrument" icon, as shown on figure below. This window can now be closed as it is not needed any more. and it should be proceeded to remote instrument access described in following sections.

In case if connection drops status "ERROR" or "WAITING" will appear in PowerView remote connection window. Connection will be automatically restored and started operation will continue.

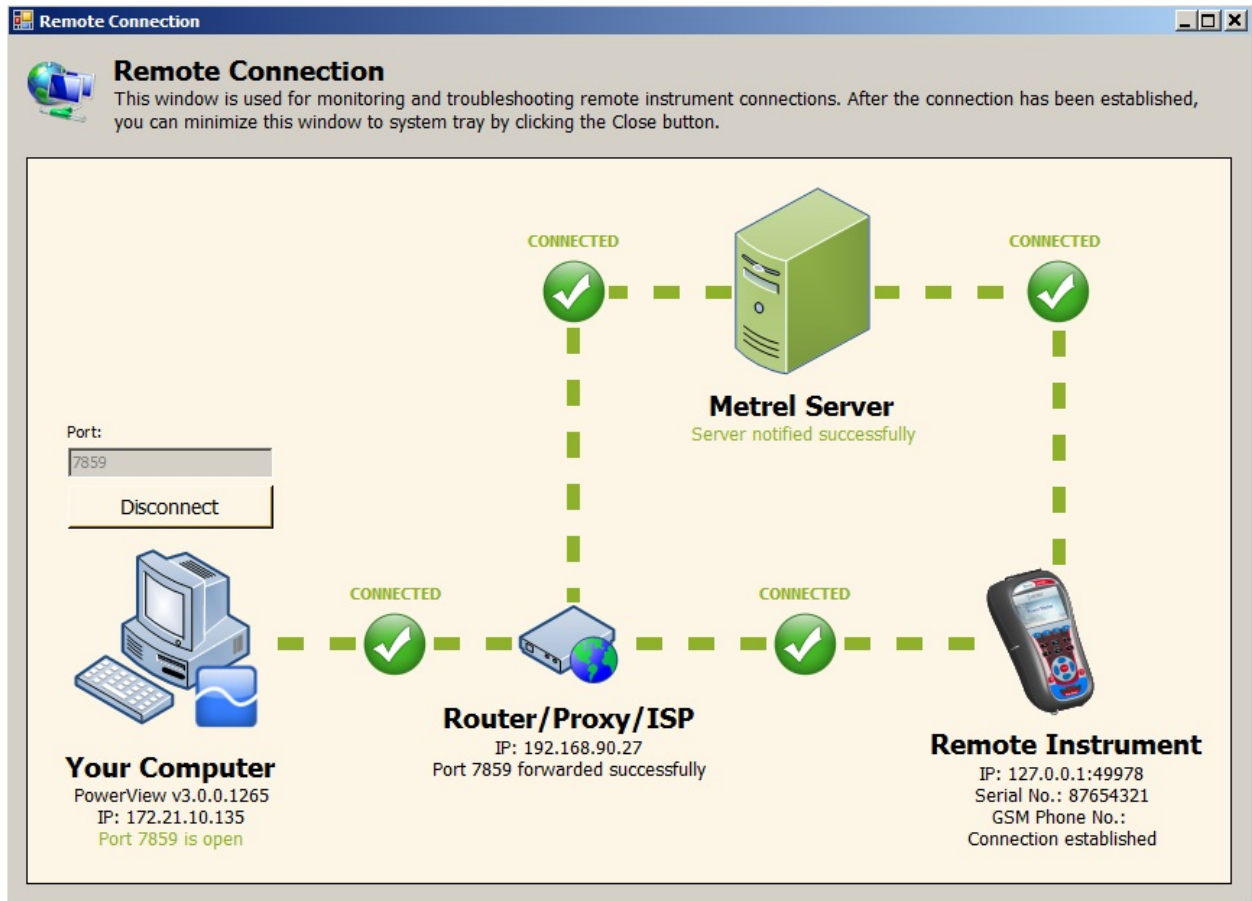

Figure 4.25: Remote instrument connection to PowerView v3.0 established (Step 4)

While the data is refreshed, the Remote button is displayed in green, to indicate that the connection is active, as shown below. If it is displayed in orange colour, it means that the communication was broken and it should be reinitialized by user.

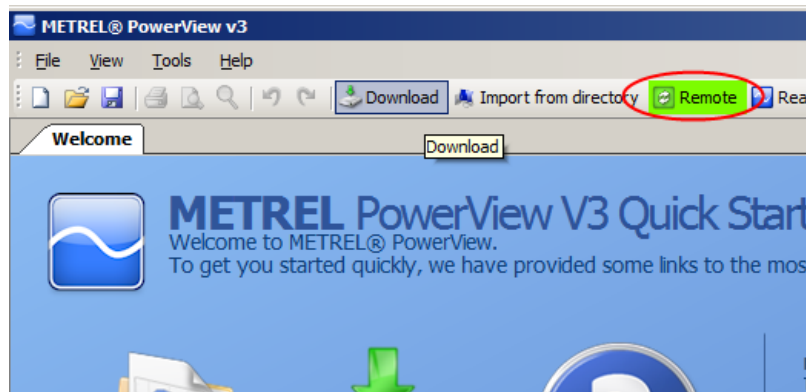

Figure 4.26: Active connection indication



Remote connection screen can also be accessed through Windows tray bar, by clicking on  icon. This is particularly useful to reconnect instrument and PowerView v3.0, after network failure.



Figure 4.27: Remote connection icon

Downloading data

If remote connection settings are correct and “Remote Instrument” is connected to PowerView v3.0, download data is possible. Open the download window by pressing F5, or by clicking on the  **Download** button in the toolbar, or by selecting Download from Tools menu.

Download window will be displayed, and PowerView v3.0 will immediately try to connect to the instrument and detect the instrument model and firmware version.

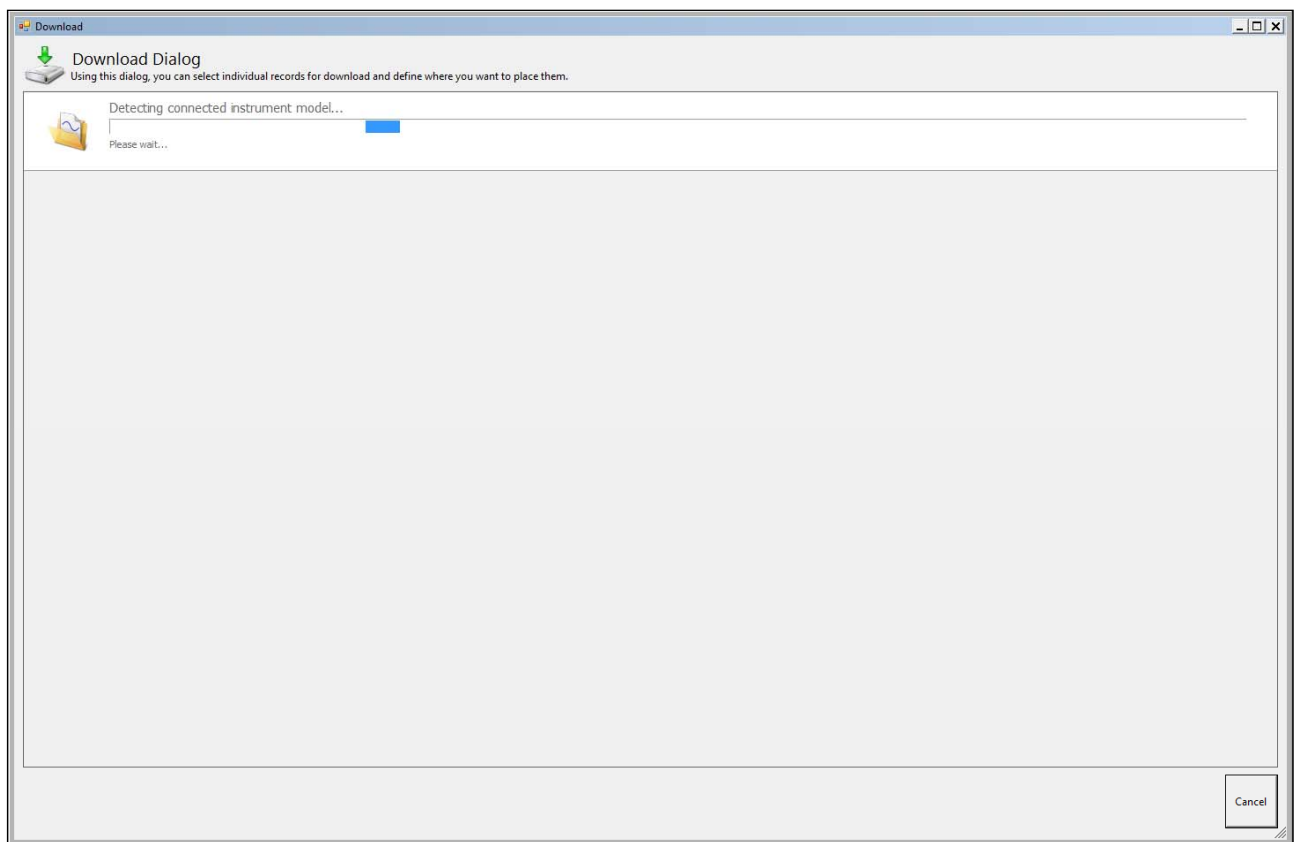

Figure 4.28: Detection of the instrument type

After a moment, instrument type should be detected, or an error message will be received, with the appropriate explanation. If connection can't be established, please check your connection settings.

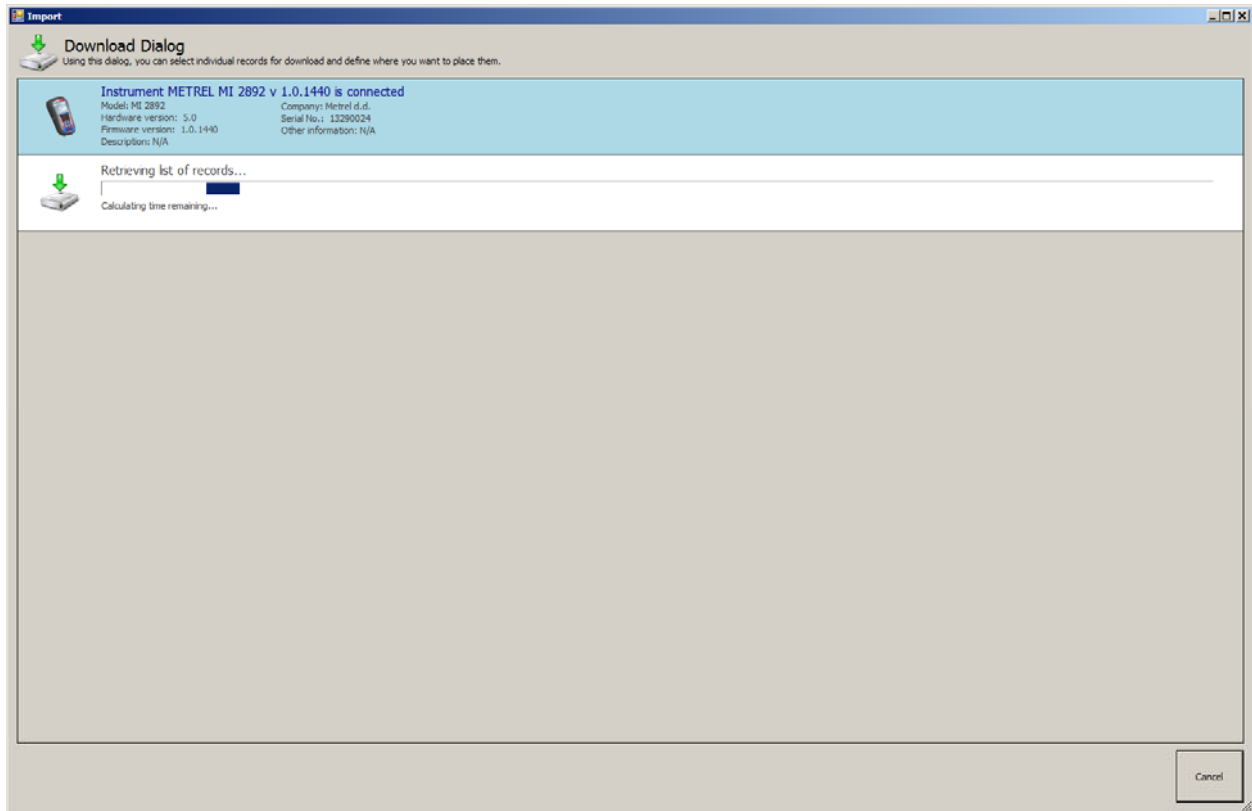

Figure 4.29: *Downloading a list of records*

When the instrument model is detected, PowerView v3.0 will download a list of records from the instrument. Any of the records from the list can be selected by simply clicking on them. Additionally, "Select/Deselect all" tick box is available to select or deselect all records on displayed page. Selected records entries will have a green background.

Before downloading, a destination site node for each record can be defined. Each entry in a list contains a drop-down list of sites in all currently open documents in PowerView v3.0. If no document is opened, all records will be downloaded to a new site and saved into a new file.

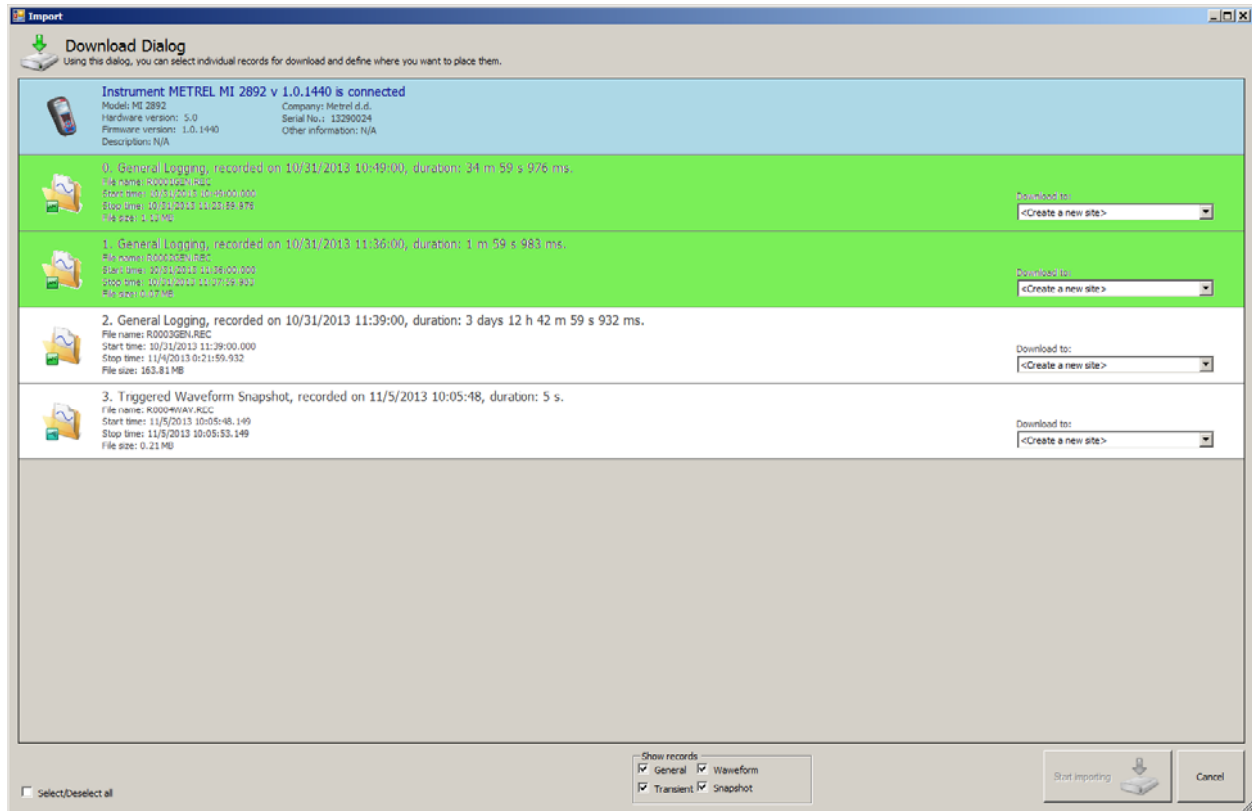
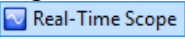

Figure 4.30: Selecting records from a list for download

Figure above show example were first two records are select. To start download, click on the “Start importing” button.

Immediately after download, a new document window will be shown in PowerView v3.0, with the selected records placed inside a new site node. A backup PowerView v3.0 file is always created at this point, compressed into a *.zip file and saved inside your *MyDocuments\Metrel/PowerView/PQData* folder. This backup copy is made every time a file is created or opened, to make sure that you can recover all your downloaded data in case of accidental delete or change. However, note that records that were not selected in the Download window are not downloaded and therefore not saved to disk, so check that all relevant records are downloaded before deleting them from the instrument.

Real time scope

If remote connection settings are correct and remote instrument is connected to PowerView v3.0, click the  button to open the Real time scope window. A new document window will be opened, as shown on the picture below.

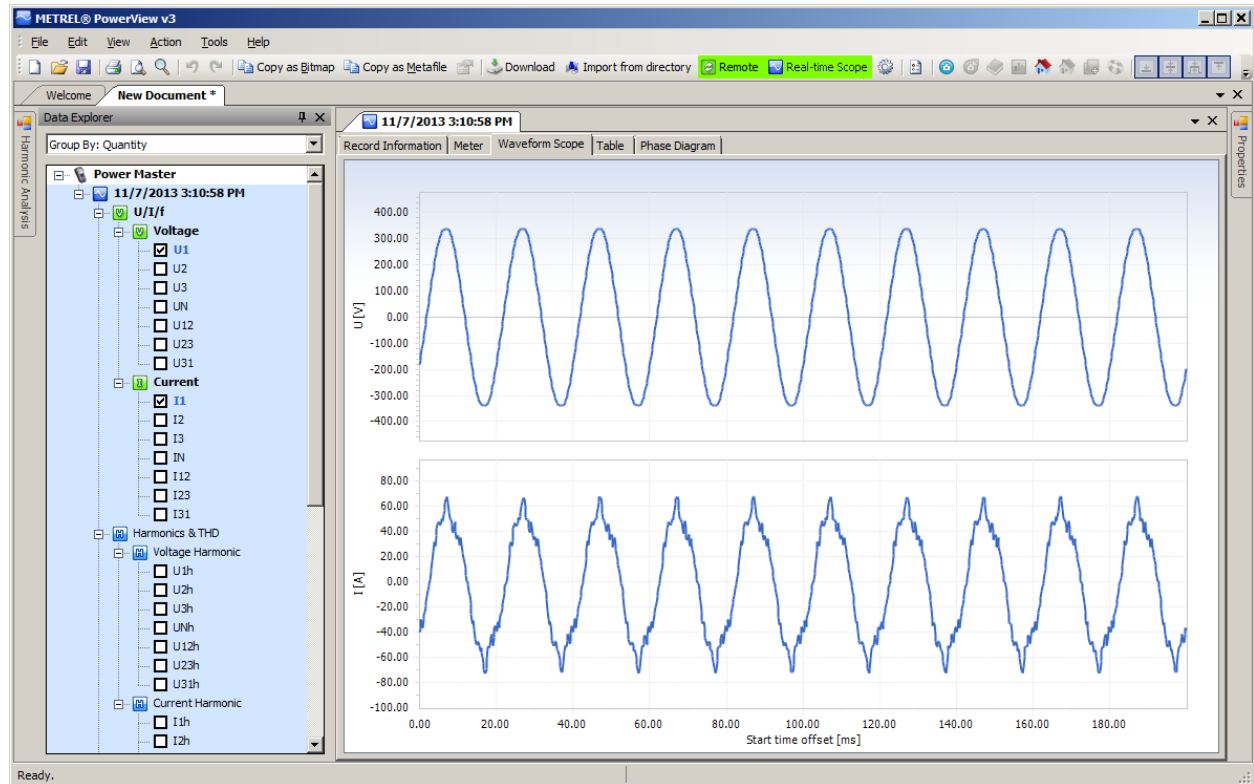

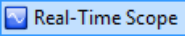

Figure 4.31: Real time scope window in remote connection, with several channels selected

The figure above shows an online window, with several channels selected. While online view is active, data are automatically updated. Updating speed will depend on your connection speed, and each new update is initiated as soon as the previous one has been downloaded, to ensure fastest possible refresh rate. While Real time scope is active,  button is displayed in green, to indicate that the connection is active.

Depending on your connection speed, it may take a few seconds until the instrument is detected and first online scope is downloaded. All tree nodes will be completely expanded when the first record is shown, to enable easier channel selection. You may also notice that the downloaded record node will not be located within a site node, like in other records, but rather placed in a special instrument node. However, this record can be moved to any other node, or saved.

To close the online view, click the  button again, or close the online window.

Remote instrument configuration

Instrument configuration tool helps you to change instrument settings, manage recording settings, start or stop recordings and manage instrument memory remotely. In order to begin, select "Remote instrument configuration" in PowerView v3.0 "Tools" menu. A form shown on figure below should pop up on the screen.

Note: Remote connection procedure described in 4.3 should be performed successfully before starting remote instrument configuration.

Figure 4.32: Remote Instrument Configuration form

Please click on the “Read” button in order to receive current instrument settings. After retrieving data from the remote instrument, form should be filled with data, as shown on figure below. Changed parameters, will be sent back to the instrument by clicking on the “Write” button.

In order to remotely control instrument recorders, please click on the “Recorder” node as shown on figure below. User can select any of the instrument recorders and configure accompanying parameters. For description of particular recorder settings, see appropriate section in this manual. Changed parameters, will be sent back to the instrument by clicking on the “Write” button.

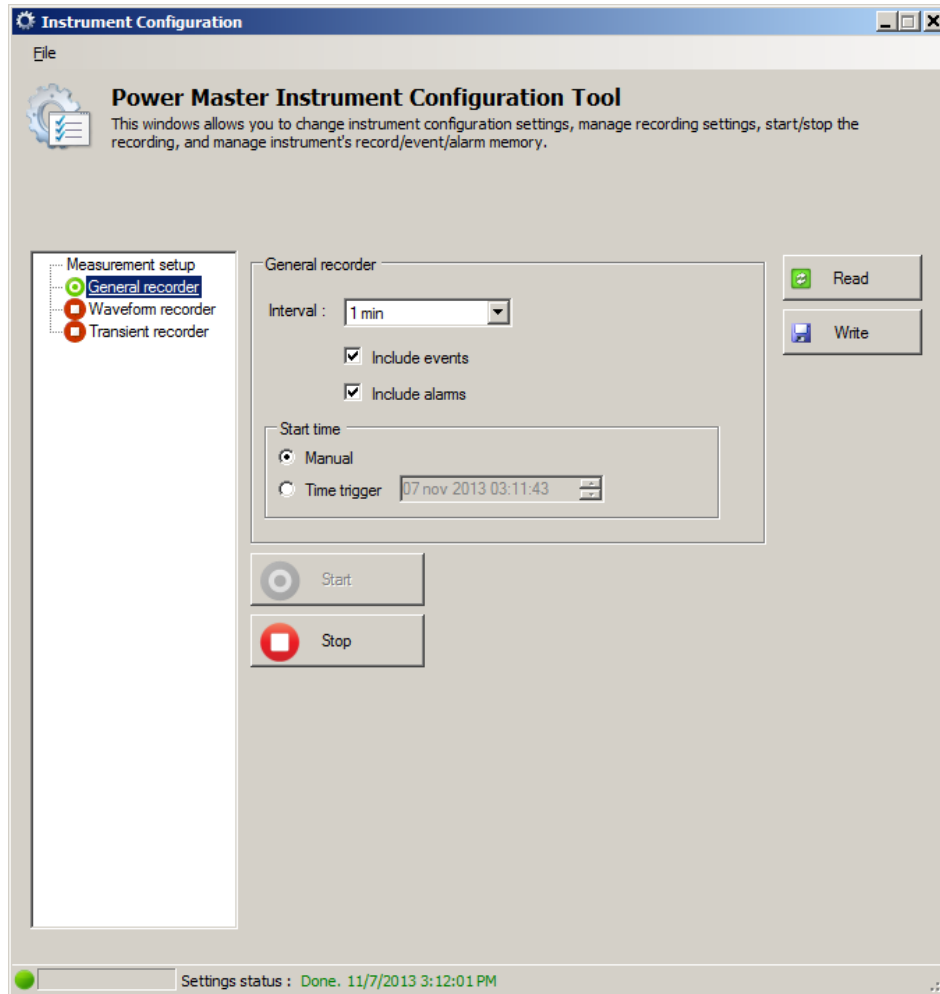

Figure 4.33: Remote Recorder configuration

By clicking on “Start” button, instrument will start selected recorder in the same manner as would user start recorder directly on instrument. Green icon indicates that Recorder is active, while red icon indicates that recorder is stopped.

Additionally PowerView v3.0 will disable changing parameters during recording. If Trigger button in waveform or transient recorder will trigger recorder in similar way as TRIGGER button on instrument, when pressed. Recording can be terminated by pressing on “Stop” button, or will automatically finish, after conditions are met, for example after given period of time or after event capturing. By pressing on “Read” button, user can receive instrument status in any moment.

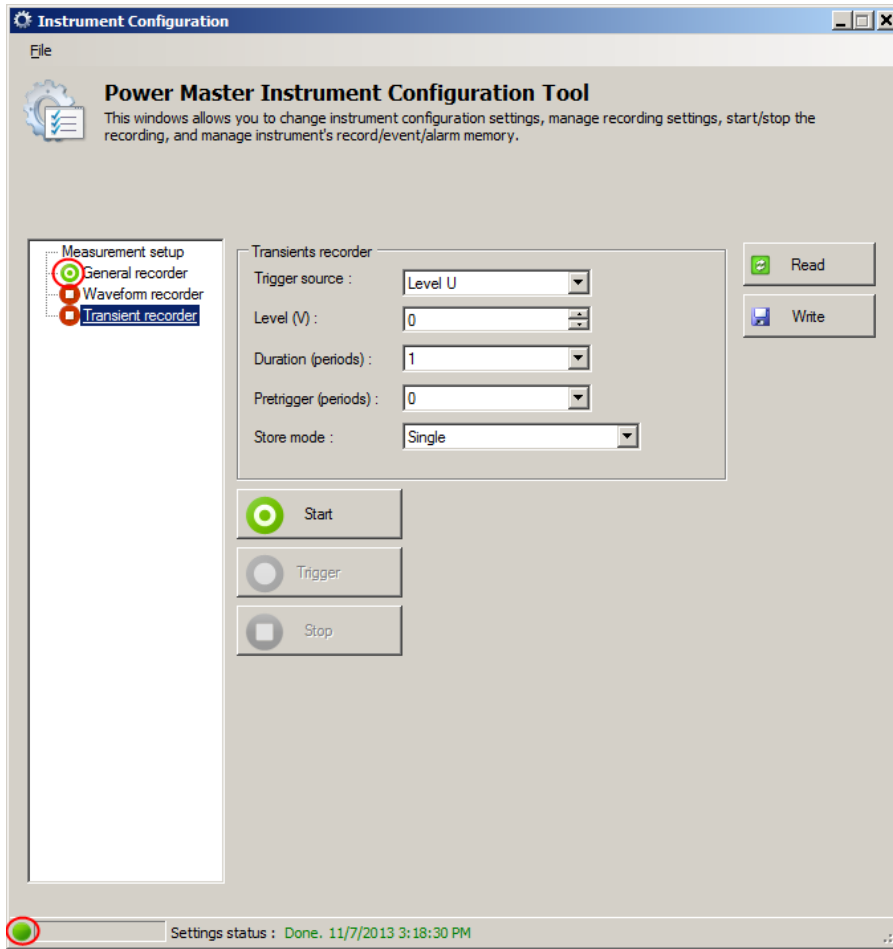

Figure 4.34: Recording in progress

4.4 Number of measured parameters and connection type relationship

Parameters which Power Master displays and measures, mainly depends on network type, defined in CONNECTION SETUP menu – **Connection** type. In example if user choose single phase connection system, only measurements relate to single phase system will be present. Table below shows dependencies between measurement parameters and type of network.

Table 4.7: Quantities measured by instrument

Menu		Connection type													
		1W		3W				4W							
		L1	GND	L12	L23	L31	Tot	L1	L2	L3	GND	L12	L23	L31	Tot
Voltage	RMS	•	•	•	•	•		•	•	•	•	•	•	•	
	THD	•	•	•	•	•		•	•	•	•	•	•	•	
	Crest Factor	•	•	•	•	•		•	•	•	•	•	•	•	
	Frequency	•		•				•							
	Harmonics (0÷50)	•	•	•	•	•		•	•	•	•	•	•	•	
	Interharm. (0÷50)	•	•	•	•	•		•	•	•	•	•	•	•	
	Unbalance						•								•
	Flicker	•		•	•	•		•	•	•					
	Signalling	•		•	•	•		•	•	•					
	Events	•		•	•	•		•	•	•					
		L1	GND	L1	L2	L3	Tot	L1	L2	L3	GND	L12	L23	L31	Tot
Current	RMS	•	•	•	•	•		•	•	•					
	THD	•	•	•	•	•		•	•	•					
	Harmonics (0÷50)	•	•	•	•	•		•	•	•					
	Interharm. (0÷50)	•	•	•	•	•		•	•	•					
	Unbalance						•								•
Consumed Pwr.	Combined	•					•	•	•	•					•
	Fundamental	•					•	•	•	•					•
	Nonfundament.	•					•	•	•	•					•
	Energy	•					•	•	•	•					•
Power factors	•					•	•	•	•					•	
Generated Pwr.	Combined	•					•	•	•	•					•
	Fundamental	•					•	•	•	•					•
	Nonfundament.	•					•	•	•	•					•
	Energy	•					•	•	•	•					•
	Power Factors	•					•	•	•	•					•

Note: Frequency measurement depends on synchronization (reference) channel, which can be voltage or current.

In the same manner recording quantities are related to connection type too. Signals in GENERAL RECORDER menu, channels selected for recording are chosen according to the Connection type, according to the next table.

Table 4.8: Quantities recorded by instrument

Menu		Connection type													
		1W		3W				4W							
		L1	GND	L12	L23	L31	Tot	L1	L2	L3	GND	L12	L23	L31	Tot
Voltage	RMS														
	THD														
	Crest Factor														
	Frequency														
	Harmonics (0÷50)														
	Interharm. (0÷50)														
	Unbalance														
	Flicker														
	Signalling														
	Events	•		•	•	•		•	•	•					
		L1	GND	L1	L2	L3	Tot	L1	L2	L3	GND	L12	L23	L31	Tot
Current	RMS														
	THD														
	Harmonics (0÷50)														
	Interharm. (0÷50)														
	Unbalance														
Power	Combined														
	Fundamental														

Nonfundament.														
Active Energy														
Reactive Ener.														
Power factors														

Legend:

- Maximal value for each interval is recorded.
- RMS or arithmetic average for each interval is recorded (see 5.1.13 for details).
- Minimal value for each interval is recorded.
- Active RMS or arithmetic average (AvgON) for each interval is recorded (see 5.1.13 for details).

5 Theory and internal operation

This section contains basic theory of measuring functions and technical information of the internal operation of the Power Master instrument, including descriptions of measuring methods and logging principles.

5.1 Measurement methods

5.1.1 Measurement aggregation over time intervals

Standard compliance: IEC 61000-4-30 Class A (Section 4.4)

The basic measurement time interval for:

- Voltage
- Current
- Power
- Harmonics
- Interharmonics
- Signalling
- Unbalance

is a 10/12-cycle time interval. The 10/12-cycle measurement is resynchronized on each **Interval** tick according to the IEC 61000-4-30 Class A. Measurement methods are based on the digital sampling of the input signals, synchronised to the fundamental frequency. Each input (4 voltages and 4 currents) is simultaneously sampled 1024 times in 10 cycles.

5.1.2 Voltage measurement (magnitude of supply voltage)

Standard compliance: IEC 61000-4-30 Class A (Section 5.2)

All voltage measurements represent RMS values of 1024 samples of the voltage magnitude over a 10/12-cycle time interval. Every 10 interval is contiguous, and not overlapping with adjacent 10 intervals.

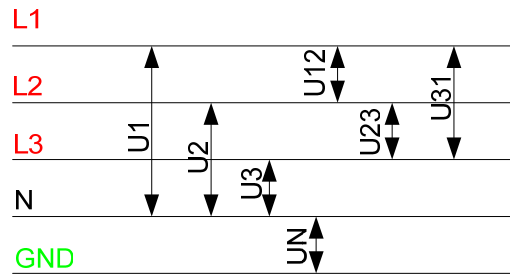

Figure 5.1: Phase and Phase-to-phase (line) voltage

Voltage values are measured according to the following equation:

$$\text{Phase voltage: } U_p = \sqrt{\frac{1}{1024} \sum_{j=1}^{1024} u_{p_j}^2} \quad [V], p: 1,2,3,N \quad (1)$$

$$\text{Line voltage: } U_{pg} = \sqrt{\frac{1}{1024} \sum_{j=1}^{1024} (u_{p_j} - u_{g_j})^2} \quad [V], pg: 12,23,31 \quad (2)$$

$$\text{Phase voltage crest factor: } CF_{U_p} = \frac{U_{pPk}}{U_p}, p: 1,2,3,N \quad (3)$$

$$\text{Line voltage crest factor: } CF_{U_{pg}} = \frac{U_{pgPk}}{U_{pg}}, pg: 12, 23, 31 \quad (4)$$

The instrument has internally 3 voltage measurement ranges, which are automatically selected regarding to the nominal voltage.

5.1.3 Current measurement (magnitude of supply current)

Standard compliance: Class A (Section A.6.3)

All current measurements represent RMS values of the 1024 samples of current magnitude over a 10/12-cycle time interval. Each 10/12-cycle interval is contiguous and non-overlapping.

Current values are measured according to the following equation:

$$\text{Phase current: } I_p = \sqrt{\frac{1}{1024} \sum_{j=1}^{1024} I_{p_j}^2} \quad [A], p: 1,2,3,N \quad (5)$$

$$\text{Phase current crest factor: } I_{p_{cr}} = \frac{I_{p_{max}}}{I_p}, p: 1,2,3,N \quad (6)$$

The instrument has internally two current ranges: 10% and 100% range of nominal transducer current. Additionally Smart current clamps models offer few measuring ranges and automatic detection.

5.1.4 Frequency measurement

Standard compliance: IEC 61000-4-30 Class A (Section 5.1)

During RECORDING with aggregation time **Interval: ≥ 10 sec** frequency reading is obtained every 10 s. As power frequency may not be exactly 50 Hz within the 10 s time clock interval, the number of cycles may not be an integer number. The fundamental frequency output is the ratio of the number of integral cycles counted during the 10 s time clock interval, divided by the cumulative duration of the integer cycles. Harmonics and interharmonics are attenuated with digital filter in order to minimize the effects of multiple zero crossings.

The measurement time intervals are non-overlapping. Individual cycles that overlap the 10 s time clock are discarded. Each 10 s interval begin on an absolute 10 s time clock, with uncertainty as specified in section 6.2.19.

For RECORDING with aggregation time **Interval: < 10 sec** and on-line measurements, frequency reading is obtained from 10/12 cycles frequency. The frequency is ratio of 10 cycles, divided by the duration of the integer cycles.

Frequency measurement is *performed* on chosen **Synchronization** channel, in CONNECTION SETUP menu.

5.1.5 Power measurement (Standard compliance: IEEE 1459-2010)

Instrument fully complies with power measurement defined in the latest IEEE 1459 standard. The old definitions for active, reactive, and apparent powers are valid as long as the current and voltage waveforms remained nearly sinusoidal. This is not the case today, where we have power electronics equipment, such as Adjustable Speed Drives, Controlled Rectifiers, Cycloconverters, Electronically Ballasted Lamps, Arc and Induction Furnaces, and clusters of Personal Computers, represent major nonlinear and parametric loads proliferating among industrial and commercial customers. New Power theory splits power to fundamental and nonfundamental components, as shown on figure below.

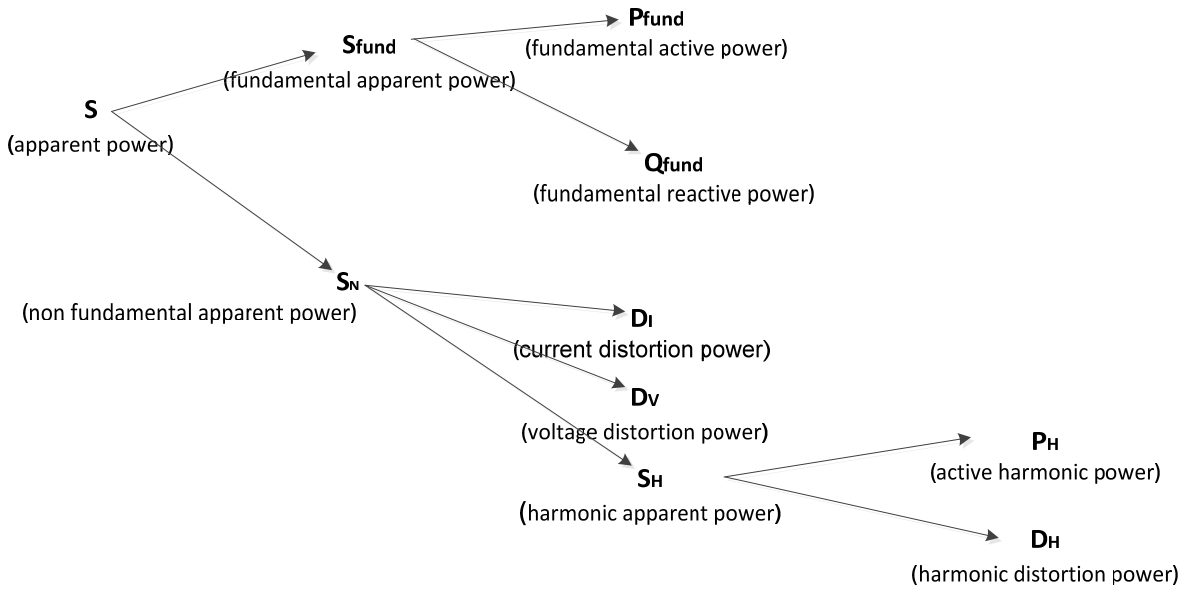

Figure 5.2: IEEE 1459 phase power measurement organisation (phase)

In table below summary of all power measurement is shown. Combined power represents “old power measurement” theory.

Table 5.1: Summary and grouping of the phase power quantities

Quantity	Combined powers	Fundamental powers	Nonfundamental Powers
Apparent (VA)	S	S _{fund}	S _N , S _H
Active (W)	P	P _{fund}	P _H
Nonactive/reactive (VAr)	N	Q _{fund}	D _I , D _V , D _H
Line utilization	PF _{ind/cap}	DPF _{ind/cap}	-
Harmonic pollution (%)	-	-	S _N /S _{fund}

Power measurement for three phase systems are slightly different as shown on figure below.

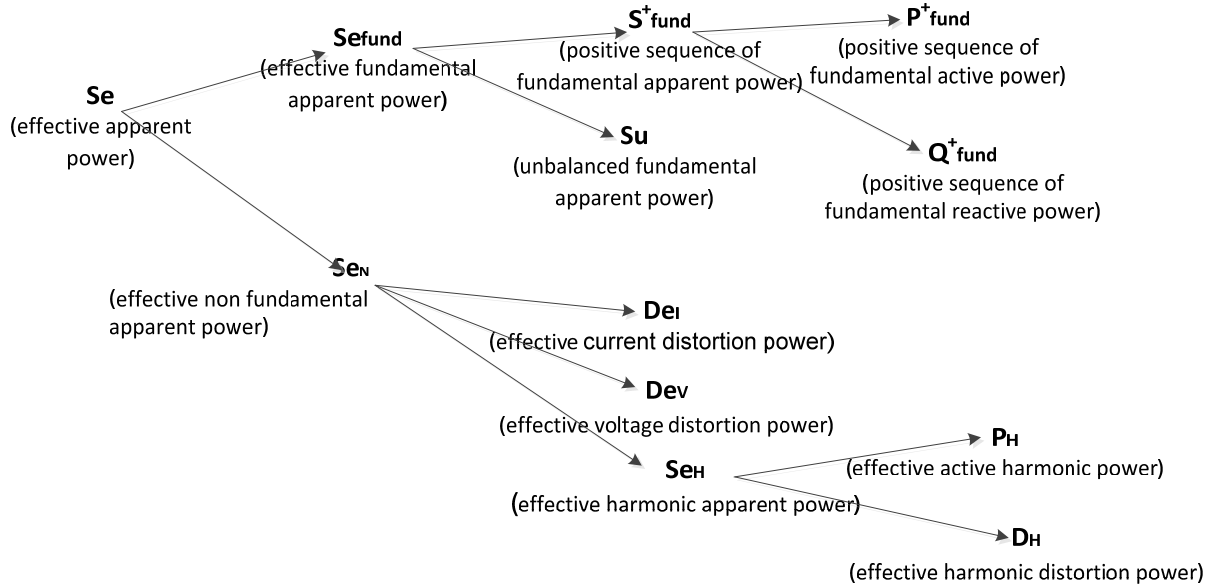

Figure 5.3: IEEE 1459 phase power measurement organisation (totals)

Table 5.2: Power summary and grouping of the total power quantities

Quantity	Combined powers	Fundamental powers	Nonfundamental Powers
Apparent (VA)	Se	Se _{fund} , S ⁺ , Su	Se _N , Se _H
Active (W)	P	P ⁺ _{tot}	P _H
Nonactive/reactive (VAr)	N	Q ⁺ _{tot}	De _I , De _V , De _H
Line utilization	PF _{ind/cap}	DPF ⁺ _{tot ind/cap}	-
Harmonic pollution (%)	-	-	Se _N /S _{fund}

Combined phase power measurements

Standard compliance: IEEE STD 1459-2010

All combined (fundamental + nonfundamental) active power measurements represent RMS values of the 1024 samples of instantaneous power over a 10/12-cycle time interval. Each 10/12-cycle interval is contiguous and non-overlapping.

Combined phase active power:

$$P_p = \frac{1}{1024} \sum_{j=1}^{1024} p_{pj} = \frac{1}{1024} \sum_{j=1}^{1024} U_{pj} * I_{pj} \quad [W], p: 1,2,3 \quad (7)$$

Combined apparent and nonactive power, and power factor are calculated according to the following equations:

Combined phase apparent power:

$$S_p = U_p * I_p \quad [VA], p: 1,2,3 \quad (8)$$

Combined phase nonactive power:

$$(9)$$

$$N_p = \text{Sign}(Q_p) \cdot \sqrt{S_p^2 - P_p^2} \quad [\text{VAr}], p: 1,2,3$$

Phase power factor: $PF_p = \frac{P_p}{S_p}, p: 1,2,3$ (10)

Total combined power measurements

Standard compliance: IEEE STD 1459-2010

Total combined (fundamental + nonfundamental) active, nonactive and apparent power and total power factor are calculated according to the following equation:

Total active power: $P_{tot} = P1 + P2 + P3$ [W], (11)

Total nonactive power: $N_{tot} = N1 + N2 + N3$ [VAr], (12)

Total apparent power (effective): $Se_{tot} = 3 \cdot U_e \cdot I_e$ [VA], (13)

Total power factor (effective): $PFe_{tot} = \frac{P_{tot}}{Se_{tot}}$. (14)

In this formula U_e and I_e are calculated differently for three phase four wire (4W) and three phase three wire (3W) systems.

Effective voltage U_e and current I_e in 4W systems:

$$I_e = \sqrt{\frac{I_1^2 + I_2^2 + I_3^2 + I_N^2}{3}} \quad U_e = \sqrt{\frac{3 \cdot (U_1^2 + U_2^2 + U_3^2) + U_{12}^2 + U_{23}^2 + U_{31}^2}{18}} \quad (15)$$

Effective voltage U_e and current I_e in 3W systems:

$$I_e = \sqrt{\frac{I_1^2 + I_2^2 + I_3^2}{3}} \quad U_e = \sqrt{\frac{U_{12}^2 + U_{23}^2 + U_{31}^2}{9}} \quad (16)$$

Fundamental phase power measurements

Standard compliance: IEEE STD 1459-2010

All fundamental power measurements are calculated from fundamental voltages and currents obtained from harmonic analysis (see section 5.1.7 for details).

Fundamental phase active power:

$$P_{fundP} = U_{fundP} \cdot I_{fundP} \cdot \cos \varphi_{U_p - I_p} \quad [\text{W}], p: 1,2,3 \quad (17)$$

Fundamental apparent and reactive power and power factor are calculated according to the following equations:

Fundamental phase apparent power:

$$S_{fundP} = U_{fundP} \cdot I_{fundP} \quad [\text{VA}], p: 1,2,3 \quad (18)$$

Fundamental phase reactive power:

$$Q_{fundP} = U_{fundP} \cdot I_{fundP} \cdot \sin \varphi_{U_p - I_p} \quad [\text{VAR}], p: 1,2,3 \quad (19)$$

Phase displacement power factor:

$$DPF_p = \cos \varphi_p = \frac{P_p}{S_p}, p: 1,2,3 \quad (20)$$

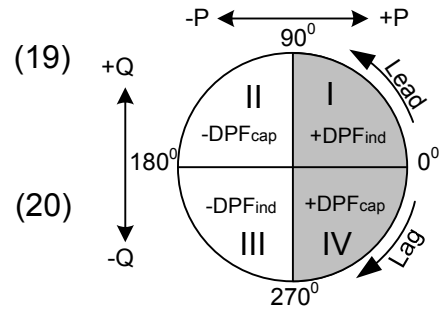

Positive sequence (total) fundamental power measurements

Standard compliance: IEEE STD 1459-2010

According to the IEEE STD 1459, positive sequence power (P^+ , Q^+ , S^+) are recognised as very important intrinsic power measurements. They are calculated according to the following equation:

Positive sequence active power:

$$P_{tot}^+ = 3 \cdot U^+ \cdot I^+ \cos \varphi^+ \quad [\text{W}], \quad (21)$$

Positive sequence reactive power:

$$Q_{tot}^+ = 3 \cdot U^+ \cdot I^+ \sin \varphi^+ \quad [\text{VAR}], \quad (22)$$

Positive sequence apparent power:

$$S_{tot}^+ = 3 \cdot U^+ \cdot I^+ \quad [\text{VA}], \quad (23)$$

Positive sequence power factor:

$$DPF_{tot}^+ = \frac{P_{tot}^+}{S_{tot}^+}. \quad (24)$$

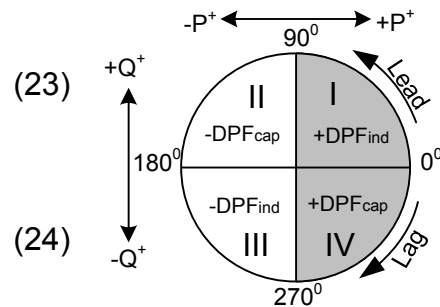

U^+ , U^- , U^0 and φ^+ are obtained from unbalance calculus. See section 5.1.10 for details.

Nonfundamental phase power measurements

Standard compliance: IEEE STD 1459-2010

Nonfundamental power measurements are measured according to following equations:

Phase nonfundamental apparent power:

$$S_{Np} = \sqrt{D_{Ip}^2 + D_{Vp}^2 + S_{Hp}^2} \quad [\text{VA}], p: 1,2,3 \quad (25)$$

Phase current distortion power

$$D_{Ip} = S_{fundP} \cdot THD_{Ip} \quad [\text{VA}], p: 1,2,3 \quad (26)$$

Phase voltage distortion power:

$$(27)$$

$$D_{Vp} = S_{fundP} \cdot THD_{Up} \quad [\text{VAr}], p: 1,2,3$$

Phase harmonic apparent power

$$S_{Hp} = S_{fundP} \cdot THD_{Up} \cdot THD_{Ip} \quad [\text{VAr}], p: 1,2,3 \quad (28)$$

Phase active harmonic power:

$$P_{Hp} = P_p - P_{fundP} \quad [\text{W}], p: 1,2,3 \quad (29)$$

Phase harmonic distortion power

$$D_{Hp} = \sqrt{S_{Hp}^2 - P_{Hp}^2} \quad [\text{VAr}], p: 1,2,3 \quad (30)$$

Total nonfundamental power measurements

Standard compliance: IEEE STD 1459-2010

Total nonfundamental power quantities are calculated according to the following equations:

Total nonfundamental effective apparent power:

$$SeN_{tot} = \sqrt{DeI_{tot}^2 + DeV_{tot}^2 + SeH_{tot}^2} \quad [\text{VA}] \quad (31)$$

Total effective current distortion power:

$$DeI_{tot} = 3 \cdot Ue_{fund} \cdot IeH \quad [\text{VAr}] \quad (32)$$

where:

$$IeH = \sqrt{Ie^2 - Ie_{fund}^2}$$

Total effective voltage distortion power:

$$DeV_{tot} = 3 \cdot Ue_H \cdot Ie_{fund} \quad [\text{VAr}] \quad (33)$$

where:

$$Ue_H = \sqrt{Ue^2 - Ue_{fund}^2}$$

Total effective apparent power:

$$SeH_{tot} = Ue_H \cdot Ie_H \quad [\text{VA}] \quad (34)$$

Total effective harmonic power:

$$PH_{tot} = PH_1 + PH_2 + PH_3 \quad [\text{W}] \quad (35)$$

where:

$$PH_1 = P_1 - P_{fund1}, \quad PH_2 = P_2 - P_{fund2}, \quad PH_3 = P_3 - P_{fund3}$$

Total effective distortion power

$$DeH = \sqrt{SeH^2 - PH^2} \quad [\text{VAr}] \quad (36)$$

Harmonic pollution

(37)

$$HP = \frac{SeN_{tot}}{Se_{fundtot}} \cdot 100 [\%]$$

where:

$$Se_{fundtot} = 3 \cdot U_{efund} \cdot I_{efund}$$

Load unbalance

$$LU = \frac{Su_{fund}}{S_{tot}^+} \quad (38)$$

5.1.6 Energy

Standard compliance: IEC 62053-22 Class 0.5S, IEC 62053-23 Class 2

Energy measurement is divided in two sections: ACTIVE energy based on active power measurement and REACTIVE energy, based on fundamental reactive power measurement. Each of them has two energy counters for consumed and generated energy.

Calculations are shown below:

Active energy:

$$\text{Consumed: } Ep_p^+ = \sum_{i=1}^m P_p^+(i)T(i) [\text{kWh}], p: 1,2,3, tot \quad (39)$$

$$\text{Generated: } Ep_p^- = \sum_{i=1}^m P_p^-(i)T(i) [\text{kWh}], p: 1,2,3, tot$$

Reactive energy:

$$\text{Consumed: } Eq_p^+ = \sum_{i=1}^m Q_{lnd}^+(i)T(i) + \sum_{i=1}^m Q_{pCap}^+(i)T(i) [\text{kVArh}], p: 1,2,3, tot \quad (40)$$

$$\text{Generated: } Eq_p^- = \sum_{i=1}^m Q_{pCap}^-(i)T(i) + \sum_{i=1}^m Q_{plnd}^-(i)T(i) [\text{kVArh}], p: 1,2,3, tot$$

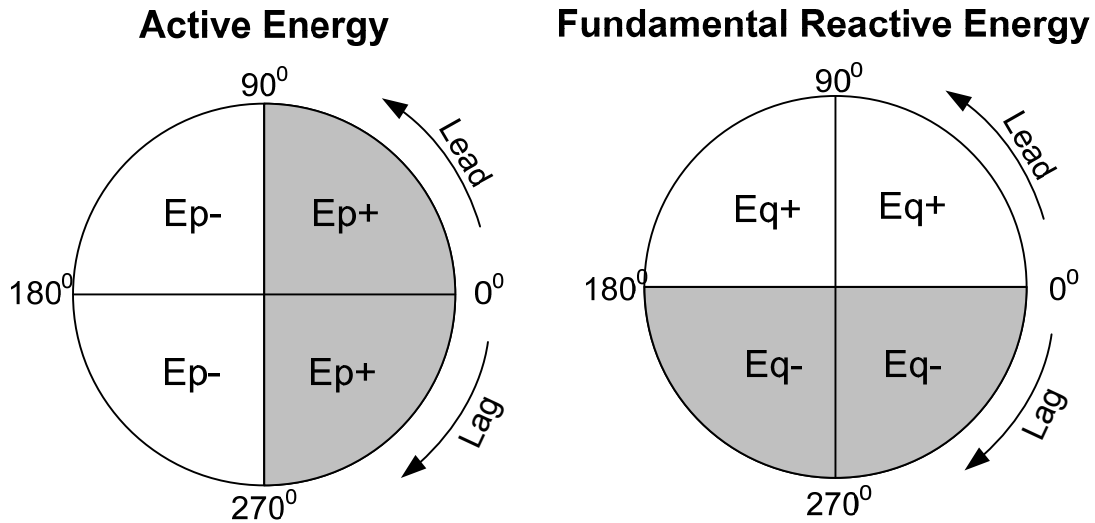

Figure 5.4: Energy counters and quadrant relationship

Instrument has 3 different counters sets:

1. Total counters **TOT** are intended for measuring energy over a complete recording. When recorder starts it sums the energy to existent state of the counters.
2. Last integration period **LAST** counter measures energy during recording over last interval. It is calculated at end of each interval.
3. Current integration period **CUR** counter measures energy during recording over current time interval.

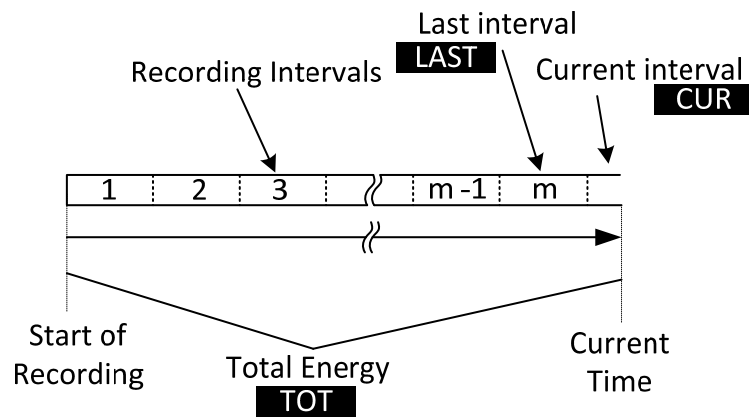

Figure 5.5: Instrument energy counters

5.1.7 Harmonics and interharmonics

Standard compliance: IEC 61000-4-30 Class (Section 5.7)
IEC 61000-4-7 Class I

Calculation called fast Fourier transformation (FFT) is used to translate AD converted input signal to sinusoidal components. The following equation describes relation between input signal and its frequency presentation.

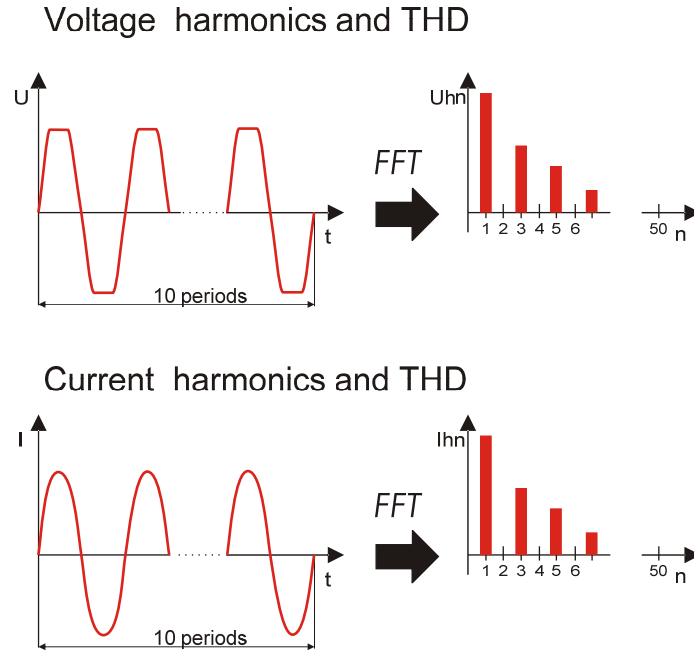

Figure 5.6: Current and voltage harmonics

$$u(t) = c_0 + \sum_{k=1}^{512} c_k \sin\left(\frac{k}{10} \cdot 2\pi f_1 t + \varphi_k\right) \quad (41)$$

f_1 – frequency of signal fundamental (in example: 50 Hz)

c_0 – DC component

k – ordinal number (order of the spectral line) related to the frequency basis $f_{C1} = \frac{1}{T_N}$

T_N – is the width (or duration) of the time window ($T_N = N \cdot T_1$; $T_1 = 1/f_1$). Time window is that time span of a time function over which the Fourier transformation is performed.

c_k – is the amplitude of the component with frequency $f_{Ck} = \frac{k}{10} f_1$

φ_k – is the phase of the component c_k

$U_{c,k}$ – is the RMS voltage value of component c_k

$I_{c,k}$ – is the RMS current value of component c_k

Phase voltage and current harmonics are calculated as RMS value of harmonic subgroup (sg): square root of the sum of the squares of the RMS value of a harmonic and the two spectral components immediately adjacent to it.

$$\text{n-th voltage harmonic: } U_p h_n = \sqrt{\sum_{k=-1}^1 U_{C,(10-n)+k}^2} \quad p: 1,2,3 \quad (42)$$

$$\text{n-th current harmonic: } I_p h_n = \sqrt{\sum_{k=-1}^1 I_{C,(10-n)+k}^2} \quad p: 1,2,3 \quad (43)$$

Total harmonic distortion is calculated as ratio of the RMS value of the harmonic subgroups to the RMS value of the subgroup associated with the fundamental:

$$\text{Total voltage harmonic distortion: } THD_{U_p} = \sqrt{\sum_{n=2}^{40} \left(\frac{U_p h_n}{U_p h_1} \right)^2}, \quad p: 1,2,3 \quad (44)$$

$$\text{Total current harmonic distortion: } THD_{I_p} = \sqrt{\sum_{n=2}^{40} \left(\frac{I_p h_n}{I_p h_1} \right)^2}, \quad p: 1,2,3 \quad (45)$$

Spectral component between two harmonic subgroups are used for interharmonics assessment. Voltage and current interharmonic subgroup of n-th order is calculated using RSS (root sum square) principle:

$$\text{n-th voltage interharmonic: } U_p i h_n = \sqrt{\sum_{k=2}^8 U_{C,(10-n)+k}^2} \quad p: 1,2,3 \quad (46)$$

$$\text{n-th current interharmonic: } I_p i h_n = \sqrt{\sum_{k=2}^8 I_{C,(10-n)+k}^2} \quad p: 1,2,3 \quad (47)$$

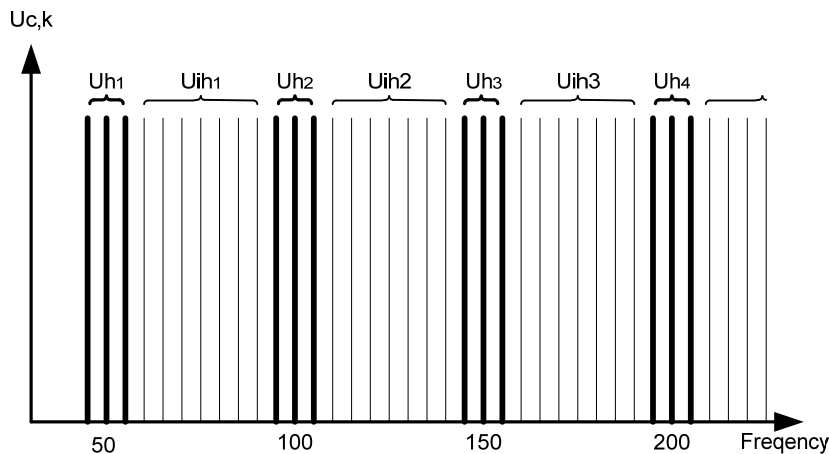

Figure 5.7: Illustration of harmonics / interharmonics subgroup for 50 Hz supply

5.1.8 Signalling

Standard compliance: IEC 61000-4-30 Class A (Section 5.10)

Signalling voltage is calculated on a FFT spectrum of a 10/12-cycle interval. Value of mains signalling voltage is measured as:

- RMS value of a single frequency bin if signalling frequency is equal to spectral bin frequency, or
- RSS value of four neighbouring frequency bins if signalling frequency differs from the power system bin frequency (for example, a ripple control signal with frequency value of 218,1 Hz in a 50 Hz power system is measured based on the RMS values of 210, 215, 220 and 225 Hz bins).

Mains signalling value calculated every 10 cycle interval are used in alarm and recording procedures. However, for EN50160 recording, results are aggregated additionally on a 3 s intervals. Those values are used for confronting with limits defined in standard.

5.1.9 Flickers

Standard compliance: IEC 61000-4-30 Class A (Section 5.3)
IEC 61000-4-15 Class F3

Flicker is a visual sensation caused by unsteadiness of a light. The level of the sensation depends on the frequency and magnitude of the lighting change and on the observer. Change of a lighting flux can be correlated to a voltage envelope on figure below.

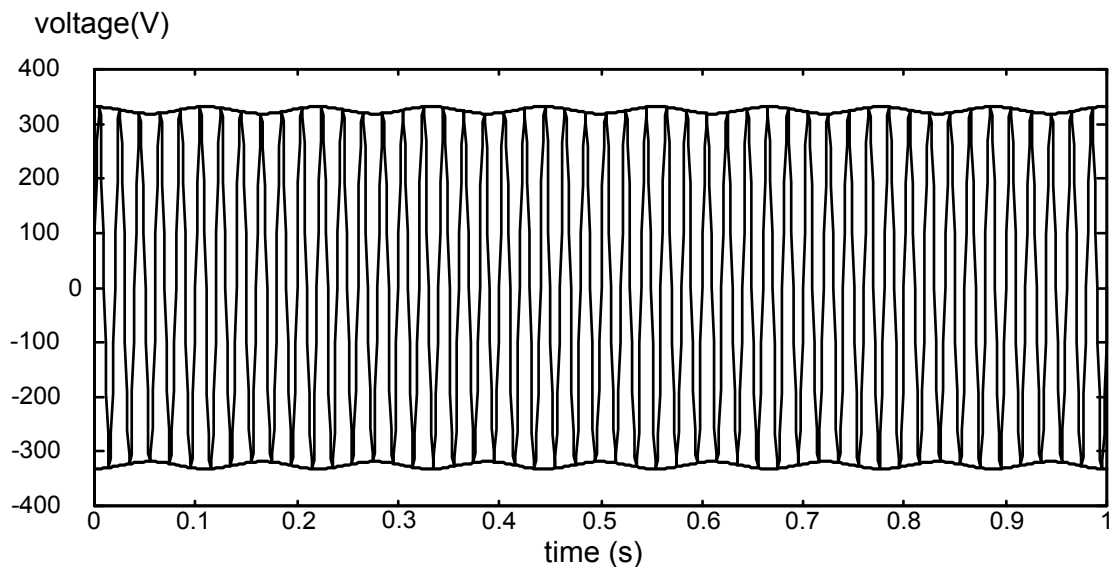

Figure 5.8: Voltage fluctuation

Flickers are measured in accordance with standard IEC 61000-4-15. Standard defines the transform function based on a 230 V / 60 W and 120 V / 60 W lamp-eye-brain chain response. That function is a base for flicker meter implementation and is presented on figure below.

$P_{stp1min}$ – is a short flicker estimation based on 1-minute interval. It is calculated to give quick preview of 10 minutes short term flicker.

P_{stp} – 10 minutes, short term flicker is calculated according to IEC 61000-4-15

P_{ltp} – 2 hours, long term flicker is calculated according to the following equation:

$$P_{ltp} = \sqrt[3]{\frac{\sum_{i=1}^N Pst_i^3}{N}} \quad p: 1,2,3 \quad (48)$$

5.1.10 Voltage and current unbalance

Standard compliance: IEC 61000-4-30 Class A (Section 5.7.1)

The supply voltage unbalance is evaluated using the method of symmetrical components. In addition to the positive sequence component U^+ , under unbalanced conditions there also exists negative sequence component U^- and zero sequence component U_0 . These quantities are calculated according to the following equations:

$$\begin{aligned}\bar{U}^+ &= \frac{1}{3}(\bar{U}_1 + a\bar{U}_2 + a^2\bar{U}_3) \\ \bar{U}_0 &= \frac{1}{3}(\bar{U}_1 + \bar{U}_2 + \bar{U}_3), \\ \bar{U}^- &= \frac{1}{3}(\bar{U}_1 + a^2\bar{U}_2 + a\bar{U}_3),\end{aligned}\quad (49)$$

where $a = \frac{1}{2} + \frac{1}{2}j\sqrt{3} = 1e^{j120^\circ}$.

For unbalance calculus, instrument use the fundamental component of the voltage input signals (U_1, U_2, U_3), measured over a 10/12-cycle time interval.

The negative sequence ratio u^- , expressed as a percentage, is evaluated by:

$$u^-(\%) = \frac{U^-}{U^+} \times 100 \quad (50)$$

The zero sequence ratio u^0 , expressed as a percentage, is evaluated by:

$$u^0(\%) = \frac{U^0}{U^+} \times 100 \quad (51)$$

Note: In 3W systems zero sequence components U_0 and I_0 are by definition zero.

The supply current unbalance is evaluated in same fashion.

5.1.11 Voltage events

Voltage dips (U_{Dip}), swells (U_{Swell}), minimum ($U_{Rms\frac{1}{2}Min}$) and maximum ($U_{Rms\frac{1}{2}Max}$) measurement method:

Standard compliance: IEC 61000-4-30 Class A (Section 5.4.1)

The basic measurement for event is $U_{Rms\frac{1}{2}}$.

$U_{Rms\frac{1}{2}}$ is value of the RMS voltage measured over 1 cycle, commencing at a fundamental zero crossing and refreshed each half-cycle.

The cycle duration for $U_{Rms\frac{1}{2}}$ depends on the frequency, which is determined by the last 10/12-cycle frequency measurement. The $U_{Rms\frac{1}{2}}$ value includes, by definition, harmonics, interharmonics, mains signalling voltage, etc.

Voltage dip

Standard compliance: IEC 61000-4-30 Class A (Section 5.4.2)

The dip threshold is a percentage of Nominal voltage defined in CONNECTION menu. The dip threshold can be set by the user according to the use. Instrument event evaluation depends on Connection type:

- On single-phase systems, a voltage dip begins when the $U_{Rms\frac{1}{2}}$ voltage falls below the dip threshold, and ends when the $U_{Rms\frac{1}{2}}$ voltage is equal to or above the dip threshold plus the 2% of hysteresis voltage (see Figure 5.9).
- On three-phase systems two different evaluation techniques can be used for evaluation simultaneously:
 - a dip begins when the $U_{Rms\frac{1}{2}}$ voltage of one or more channels is below the dip threshold and ends when the $U_{Rms\frac{1}{2}}$ voltage on all measured channels is equal to or above the dip threshold plus the 2% of hysteresis voltage.
 - a voltage dip begins when the $U_{Rms\frac{1}{2}}$ voltage of one channel falls below the dip threshold, and ends when the $U_{Rms\frac{1}{2}}$ voltage is equal to or above the dip threshold plus the 2% of hysteresis voltage, on the same phase.

A voltage dip is characterized by a pair of data: residual voltage U_{Dip} and dip duration:

- U_{Dip} is the residual voltage, the lowest $U_{Rms\frac{1}{2}}$ value measured on any channel during the dip.
- The start time of a dip is time stamped with the time of the start of the $U_{Rms\frac{1}{2}}$ of the channel that initiated the event, and the end time of the dip is time stamped with the time of the end of the $U_{Rms\frac{1}{2}}$ that ended the event, as defined by the threshold.
- The duration of a voltage dip is the time difference between the start time and the end time of the voltage dip.

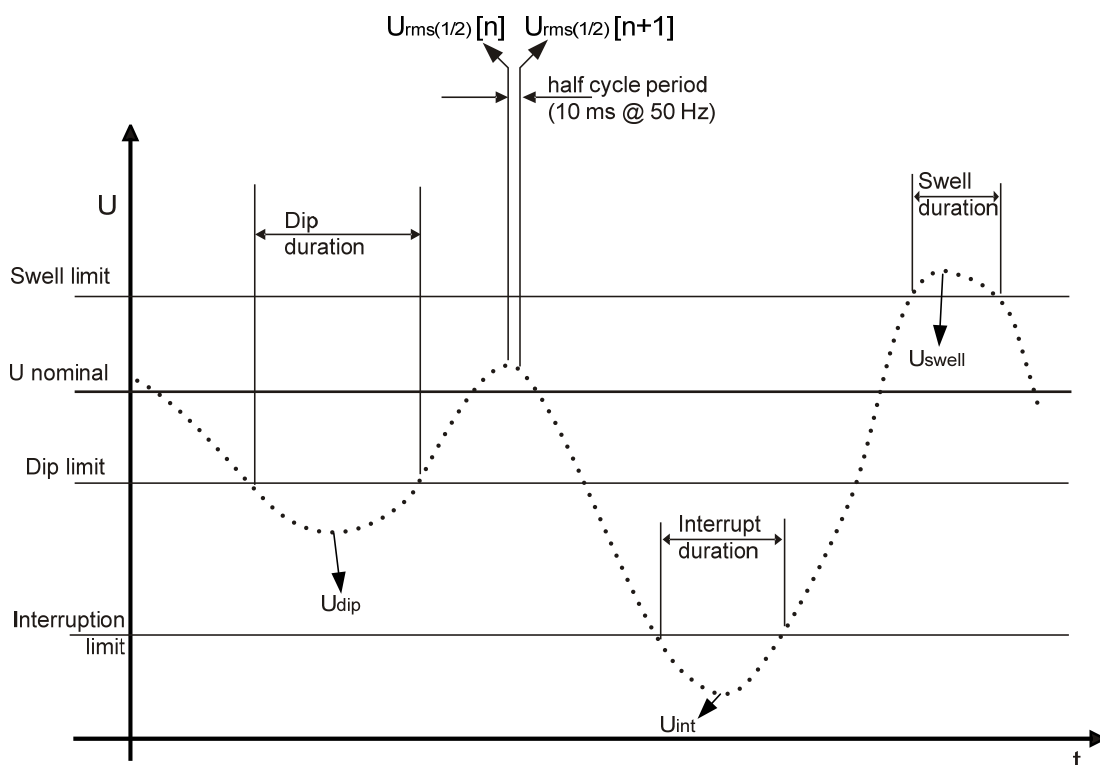

Figure 5.9 Voltage events definition

Voltage swell

Standard compliance: IEC 61000-4-30 Class A (Section 5.4.3)

The swell threshold is a percentage of nominal voltage defined in Voltage events setup menu. The swell threshold can be set by the user according to the use. Instrument permits swell evaluation:

- on single-phase systems, a voltage swell begins when the $U_{Rms\frac{1}{2}}$ voltage rises above the swell threshold, and ends when the $U_{Rms\frac{1}{2}}$ voltage is equal to or below the swell threshold plus the 2% of hysteresis voltage (see Figure 5.9),
- on three-phase systems two different evaluation techniques can be used for evaluation simultaneously:
 - A swell begins when the $U_{Rms\frac{1}{2}}$ voltage of one or more channels is above the swell threshold and ends when the $U_{Rms\frac{1}{2}}$ voltage on all measured channels is equal to or below the swell threshold plus the 2% of hysteresis voltage.
 - A swell begins when the $U_{Rms\frac{1}{2}}$ voltage of one channel rises above the swell threshold, and ends when the $U_{Rms\frac{1}{2}}$ voltage is equal to or below the swell threshold plus the 2% of hysteresis voltage, on the same phase.

A voltage swell is characterized by a pair of data: maximum swell voltage magnitude, and duration:

- U_{Swell} – maximum swell magnitude voltage is the largest $U_{Rms\frac{1}{2}}$ value measured on any channel during the swell.
- The start time of a swell is time stamped with the time of the start of the $U_{Rms\frac{1}{2}}$ of the channel that initiated the event and the end time of the swell is time stamped with the time of the end of the $U_{Rms\frac{1}{2}}$ that ended the event, as defined by the threshold.
- The duration of a voltage swell is the time difference between the beginning and the end of the swell.

Voltage interrupt

Standard compliance: IEC 61000-4-30 Class A (Section 5.5)

Measuring method for voltage interruptions detection is same as for dips and swells, and is described in previous sections.

The interrupt threshold is a percentage of nominal voltage defined in Voltage events setup menu. The interrupt threshold can be set by the user according to the use. Instrument permits interrupt evaluation:

- On single-phase systems, a voltage interruption begins when the $U_{Rms\frac{1}{2}}$ voltage falls below the voltage interruption threshold and ends when the $U_{Rms\frac{1}{2}}$ value is equal to, or greater than, the voltage interruption threshold plus the hysteresis (see Figure 5.9),
- on three-phase systems two different evaluation techniques can be used for evaluation simultaneously:
 - a voltage interruption begins when the $U_{Rms\frac{1}{2}}$ voltages of all channels fall below the voltage interruption threshold and ends when the $U_{Rms\frac{1}{2}}$ voltage on any one channel is equal to, or greater than, the voltage interruption threshold plus the hysteresis.
 - a voltage interrupt begins when the $U_{Rms\frac{1}{2}}$ voltage of one channel fall below the interrupt threshold, and ends when the $U_{Rms\frac{1}{2}}$ voltage is equal to or above the interrupt threshold plus the 2% of hysteresis voltage, on the same phase.

A voltage interrupt is characterized by a pair of data: minimal interrupt voltage magnitude, and duration:

- U_{int} – minimum interrupt magnitude voltage is the lowest $U_{Rms\frac{1}{2}}$ value measured on any channel during the interrupt.
- The start time of a interrupt is time stamped with the time of the start of the $U_{Rms\frac{1}{2}}$ of the channel that initiated the event, and the end time of the interrupt is time stamped with the time of the end of the $U_{Rms\frac{1}{2}}$ that ended the event, as defined by the threshold.
- The duration of a voltage interrupt is the time difference between the beginning and the end of the interrupt.

5.1.12 Alarms

Generally alarm can be seen as an event on arbitrary quantity. Alarms are defined in alarm table (see section 3.19.3 for alarm table setup). The basic measurement time interval for: voltage, current, active, nonactive and apparent power, harmonics and unbalance alarms is a 10/12-cycle time interval.

Each alarm has attributes described in table below. Alarm occurs when 10/12-cycle measured value on phases defined as **Phase**, cross **Threshold value** according to defined **Trigger slope**, minimally for **Minimal duration** value.

Table 5.3: Alarm definition parameters

Quantity	<ul style="list-style-type: none"> • Voltage • Current • Frequency • Active, nonactive and apparent power • Harmonics and interharmonics • Unbalance • Flickers • Signalling
Phase	L1, L2, L3, L12, L23, L31, All, Tot, N
Trigger slope	< - Fall , > - Rise
Threshold value	[Number]
Minimal duration	200ms ÷ 10min

Each captured alarm is described by the following parameters:

Table 5.4: Alarm signatures

Date	Date when selected alarm has occurred
Start	Alarm start time - when first value cross threshold.
Phase	Phase on which alarm occurred
Level	Minimal or maximal value in alarm
Duration	Alarm duration

5.1.13 Data aggregation in GENERAL RECORDING

Standard compliance: IEC 61000-4-30 Class A (Section 4.5.3)

Time aggregation period (IP) during recording is defined with parameter Interval: x min in GENERAL RECORDER menu.

A new recording interval commence at real time clock tick (10 minutes ± half cycle) and it last until next real time clock plus time needed to finish current 10/12 cycle measurement. In the same time new measurement is started, as shown on next figure. The data for the IP time interval are aggregated from 10/12-cycle time intervals, according to the figure below. The aggregated interval is tagged with the absolute time. The time tag is the time at the conclusion of the interval. There is overlap, during recording, as illustrated on figure below.

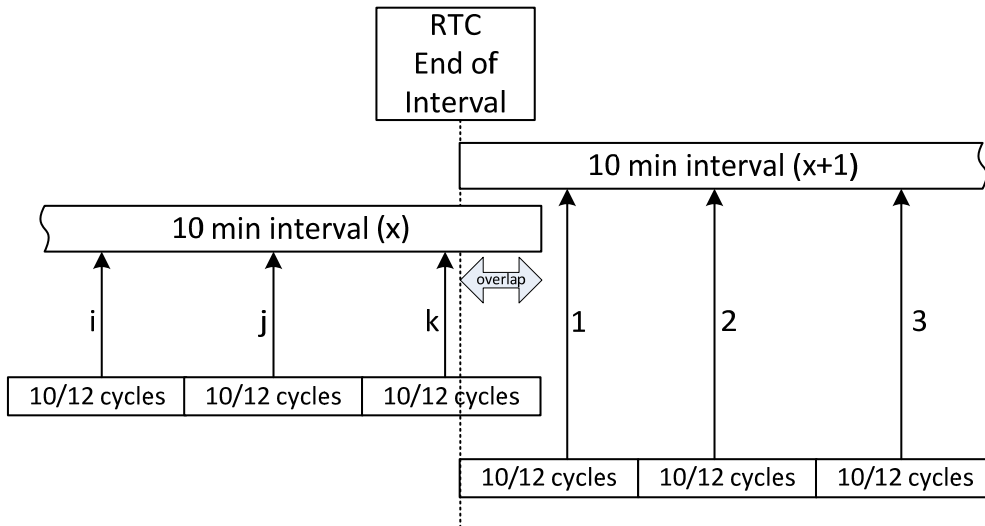

Figure 5.10: Synchronization and aggregation of 10 cycle intervals

Depending from the quantity, for each aggregation interval instrument computes average, minimal, maximal and/or active average value., this can be RMS (root means square) or arithmetical average. Equations for both averages are shown below.

RMS average
$$A_{RMS} = \sqrt{\frac{1}{N} \sum_{j=1}^N A_j^2} \tag{52}$$

Where:

A_{RMS} – quantity average over given aggregation interval

A – 10/12-cycle quantity value

N – number of 10 cycles measurements per aggregation interval.

Arithmetic average:
$$A_{avg} = \frac{1}{N} \sum_{j=1}^N A_j \tag{53}$$

Where:

A_{avg} – quantity average over given aggregation interval

A – 10/12-cycle quantity value

N – number of 10 cycles measurements per aggregation interval.

In the next table averaging method for each quantity is specified:

Table 5.5: Data aggregation methods

Group	Value	Aggregation method	Recorded values
Voltage	U_{Rms}	RMS average	Min, Avg, Max
	THD_U	RMS average	Avg, Max
	CF_U	RMS average	Min, Avg, Max
Current	I_{Rms}	RMS average	Min, Avg, AvgOn, Max
	THD_I	RMS average	Min, Avg, AvgOn, Max
	CF_I	RMS average	Min, Avg, AvgOn, Max
Frequency	f(10s)	-	
	f(200ms)	RMS average	Min, AvgOn, Max
Power	Combined	Arithmetic average	Min, Avg, AvgOn, Max
	Fundamental	Arithmetic average	Min, Avg, AvgOn, Max
	Nonfundamental	Arithmetic average	Min, Avg, AvgOn, Max
Unbalance	U^+	RMS	Min, Avg, Max
	U^-	RMS	Min, Avg, Max
	U^0	RMS	Min, Avg, Max
	u-	RMS	Min, Avg, Max
	u0	RMS	Min, Avg, Max
	I^+	RMS	Min, Avg, AvgOn, Max
	I^-	RMS	Min, Avg, AvgOn, Max
	I^0	RMS	Min, Avg, AvgOn, Max
	i-	RMS	Min, Avg, AvgOn, Max
i0	RMS	Min, Avg, AvgOn, Max	
Harmonics	DC, $U_{h_{0+50}}$	RMS	Avg, Max
	DC, $I_{h_{0+50}}$	RMS	Avg, AvgOn, Max
Interharmonics	$U_{h_{0+50}}$	RMS	Avg, Max
	$I_{h_{0+50}}$	RMS	Avg, AvgOn, Max
Signalling	U_{Sig}	RMS	Min, Avg, Max

An *active average* value is calculated upon the same principle (arithmetic or RMS) as average value, but taking in account only measurement where measured value is not zero:

$$\text{RMS active average} \quad A_{RMSact} = \sqrt{\frac{1}{M} \sum_{j=1}^M A_j^2}; M \leq N \quad (54)$$

Where:

A_{RMSact} – quantity average over active part of given aggregation interval,

A – 10/12-cycle quantity value marked as “active”,

M – number of 10 cycles measurements with active (non zero) value.

$$\text{Arithmetic active average:} \quad A_{avgact} = \frac{1}{M} \sum_{j=1}^M A_j; M \leq N \quad (55)$$

Where:

A_{avgact} – quantity average over active part of given aggregation interval,

A – 10/12-cycle quantity value in “active” part of interval,
 M – number of 10 cycles measurements with active (non zero) value.

Power and energy recording

Active power is divided into two parts: import (positive-consumed) and export (negative-generated). Nonactive power and power factor are divided into four parts: positive inductive (+i), positive capacitive (+c), negative inductive (-i) and negative capacitive (-c).

Consumed/generated and inductive/capacitive phase/polarity diagram is shown on figure below:

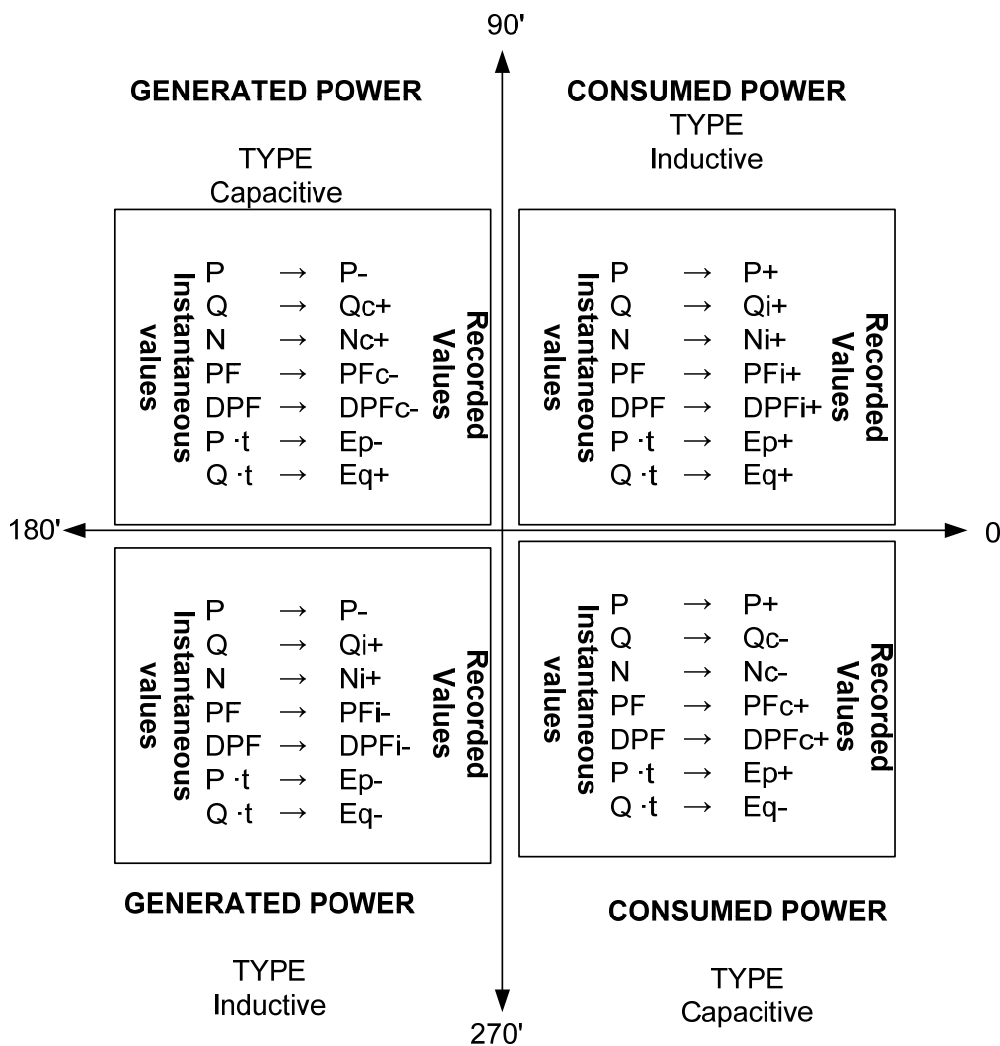



Figure 5.11: Consumed/generated and inductive/capacitive phase/polarity diagram

5.1.14 Waveform snapshot

During measurement campaign Power Master has the ability to take waveform snapshot. This is particularly useful for storing temporary characteristics or network behaviour. Snapshot stores all network signatures and waveform samples for 10 cycles.

Using MEMORY LIST function (see 3.18) or with PowerView v3.0 software, user can observe stored data.



Long press on  triggers WAVEFORM SNAPSHOT. Instrument will record all measured parameters into file.

5.1.15 Waveform record

Waveform recorder can be used in order to capture waveform of particular network event: such as voltage event, inrush or alarm. In waveform record samples of voltage and current are stored for given duration. Waveform recorder starts when the pre-set trigger occurs. Storage buffer is divided into pre-trigger and post-trigger buffers. Pre and post-trigger buffers are composed of waveform snapshots taken before and after trigger occurrence, as shown on following figure.

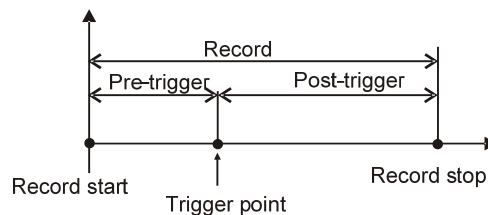

Figure 5.12: Triggering and pre-triggering description

Several trigger sources are possible:

- Manual trigger - user manually triggers waveform recording.
- Voltage events – instrument starts waveform recorder when voltage event occur.
- Voltage level – instrument starts waveform recorder when measured voltage reaches given voltage threshold.
- Current level - instrument starts waveform recorder when measured current reaches given current threshold.
- Alarms – instrument starts waveform recorder when alarm from alarm list is detected.
- Voltage events and alarms – instrument starts waveform recorder when either voltage event or alarm occur.

User can perform single or continuous waveform recordings up to 200 records. In continuous waveform recording, Power Master will automatically initialize next waveform recording upon completion of the previous one.

Inrush recorder

In addition to the waveform record which represent voltage samples, instrument also store RMS voltage $U_{Rms\frac{1}{2}}$ and current $I_{Rms\frac{1}{2}}$. This type of record is particularly suitable for capturing motor inrush. It gives analysis of voltage and current fluctuations during start of motor or other high power consumers. For current $I_{Rms\frac{1}{2}}$ value (half cycle period RMS current refreshed each half cycle) is measured, while for voltage $U_{Rms\frac{1}{2}}$ values (one cycle RMS voltage refreshed each half cycle) is measured for each interval. In following figures, Level triggering is shown.

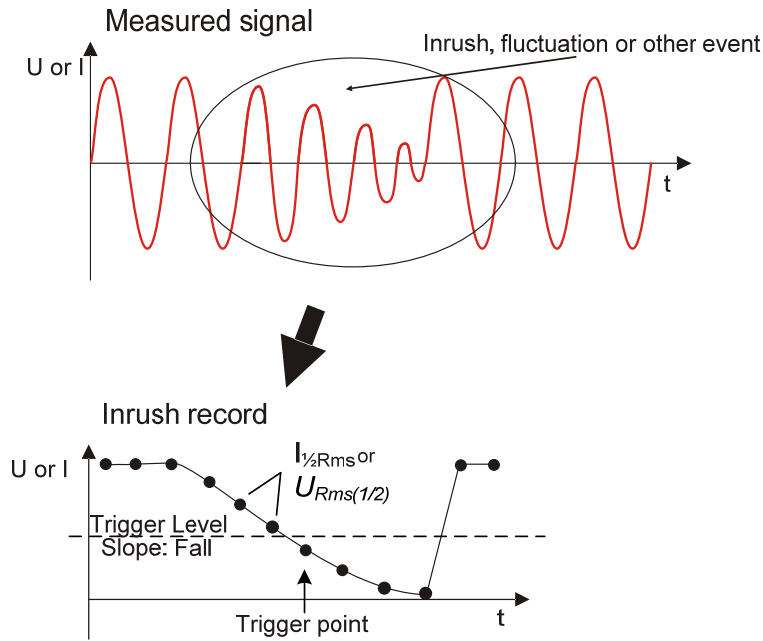

Figure 5.13: Level triggering

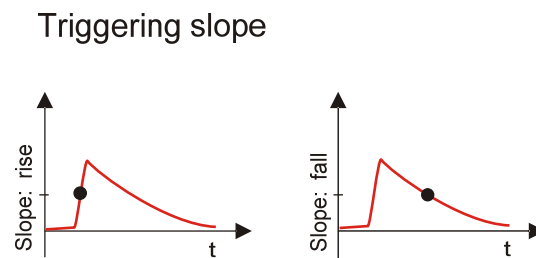

Figure 5.14: Triggering slope

5.1.16 Transient recorder

Transient recorder is similar to waveform recorder. It stores a selectable set of pre- and post-trigger samples on trigger activation, but with 10 times higher sampling rate.

Recorder can be triggered on envelope or level.

Envelope trigger is activated if difference between same samples on two consecutive periods of input voltage signals, is greater than given limit.

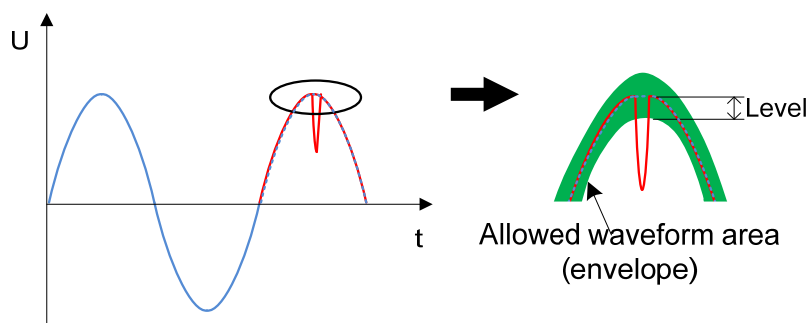

Figure 5.15: Transients trigger detection (envelope)

Level trigger is activated if sampled voltage is greater than given limit.

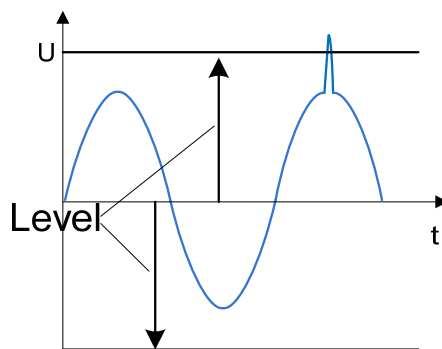

Figure 5.16: Transients trigger detection (envelope)

Note: Saving to the instrument data memory induces dead time between consecutive transient records. Dead time is proportional to record duration, and in worst case for 50 sec long transient it will take 4 seconds, before new transient can be captured.

5.2 EN 50160 Standard Overview

EN 50160 standard defines, describes and specifies the main characteristics of the voltage at a network user's supply terminals in public low voltage and medium voltage distribution networks under normal operating conditions. This standard describe the limits or values within which the voltage characteristics can be expected to remain over the whole of the public distribution network and do not describe the average situation usually experienced by an individual network user. An overview of EN 50160 limits are presented on table below.

Table 5.6: EN 50160 standard overview (continuous phenomena)

Supply voltage phenomenon	Acceptable limits	Meas. Interval	Monitoring Period	Acceptance Percentage
Power frequency	49.5 ÷ 50.5 Hz 47.0 ÷ 52.0 Hz	10 s	1 Week	99,5% 100%
Supply voltage variations, U_{Nom}	230V ± 10% 230V +10% -15%	10 min	1 Week	95% 100%
Flicker severity Plt	Plt ≤ 1	2 h	1 Week	95%
Voltage unbalance u-	0 ÷ 2 %, occasionally 3%	10 min	1 Week	95%
Total harm. distortion, THD _U	8%	10 min	1 Week	95%
Harmonic Voltages, U_{h_n}	See Table 5.7	10 min	1 Week	95%
Mains signalling	See Figure 5.17	2 s	1 Day	99%

5.2.1 Power frequency

The nominal frequency of the supply voltage shall be 50 Hz, for systems with synchronous connection to an interconnected system. Under normal operating

conditions the mean value of the fundamental frequency measured over 10 s shall be within a range of:

50 Hz \pm 1 % (49,5 Hz .. 50,5 Hz) during 99,5 % of a year;

50 Hz + 4 % / - 6 % (i.e. 47 Hz .. 52 Hz) during 100 % of the time.

5.2.2 Supply voltage variations

Under normal operating conditions, during each period of one week 95 % of the 10 min mean U_{Rms} values of the supply voltage shall be within the range of $U_{Nom} \pm 10$ %, and all U_{Rms} values of the supply voltage shall be within the range of $U_{Nom} + 10$ % / - 15 %.

5.2.3 Supply voltage unbalance

Under normal operating conditions, during each period of one week, 95 % of the 10 min mean RMS values of the negative phase sequence component (fundamental) of the supply voltage shall be within the range 0 % to 2 % of the positive phase sequence component (fundamental). In some areas with partly single phase or two-phase connected network users' installations, unbalances up to about 3 % at three-phase supply terminals occur.

5.2.4 THD voltage and harmonics

Under normal operating conditions, during each period of one week, 95 % of the 10 min mean values of each individual harmonic voltage shall be less or equal to the value given in table below.

Moreover, THD_U values of the supply voltage (including all harmonics up to the order 40) shall be less than or equal to 8 %.

Table 5.7: Values of individual harmonic voltages at the supply

Odd harmonics				Even harmonics	
Not Multiples of 3		Multiples of 3		Order h	Relative voltage (U_N)
Order h	Relative voltage (U_N)	Order h	Relative voltage (U_N)		
5	6,0 %	3	5,0 %	2	2,0 %
7	5,0 %	9	1,5 %	4	1,0 %
11	3,5 %	15	0,5 %	6..24	0,5 %
13	3,0 %	21	0,5 %		
17	2,0 %				
19	1,5 %				
23	1,5 %				
25	1,5 %				

5.2.5 Interharmonic voltage

The level of interharmonics is increasing due to the development of frequency converters and similar control equipment. Levels are under consideration, pending more experience. In certain cases interharmonics, even at low levels, give rise to flickers (see 5.2.7), or cause interference in ripple control systems.

5.2.6 Mains signalling on the supply voltage

In some countries the public distribution networks may be used by the public supplier for the transmission of signals. Over 99 % of a day the 3 s mean of signal voltages shall be less than or equal to the values given in the following figure.

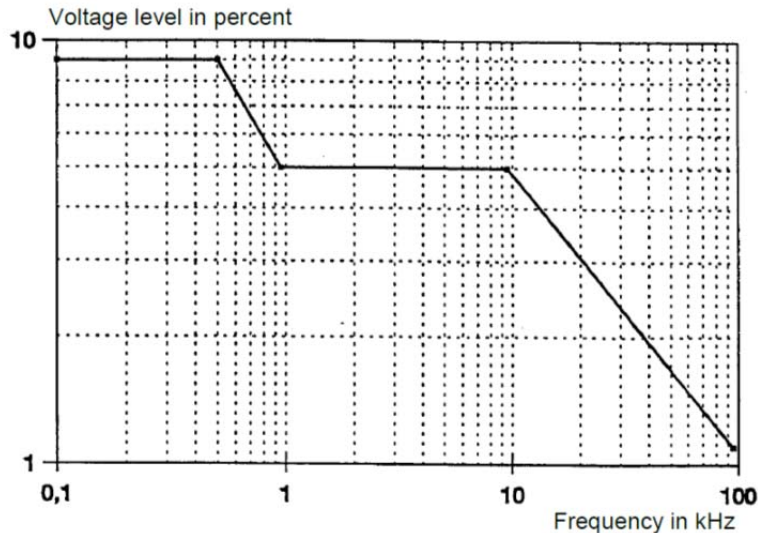

Figure 5.17: Mains signalling voltage level limits according to EN50160

5.2.7 Flicker severity

Under normal operating conditions, in any period of one week the long term flicker severity caused by voltage fluctuation should be $P_{ft} \leq 1$ for 95 % of the time.

5.2.8 Voltage dips

Voltage dips are typically originated by faults occurring in the public network or in network users installations. The annual frequency varies greatly depending on the type of supply system and on the point of observation. Moreover, the distribution over the year can be very irregular. The majority of voltage dips have duration less than 1 s and a retained voltage greater than 40 %. Conventionally, the dip start threshold is equal to 90 % of the nominal voltage of the nominal voltage. Collected voltage dips are classified according to the following table.

Table 5.8: Voltage dips classification

Residual voltage	Duration (ms)				
	$10 \leq t \leq 200$	$200 < t \leq 500$	$500 < t \leq 1000$	$1000 < t \leq 5000$	$5000 < t \leq 60000$
$90 > U \geq 80$	Cell A1	Cell A2	Cell A3	Cell A4	Cell A5
$80 > U \geq 70$	Cell B1	Cell B2	Cell B3	Cell B4	Cell B5
$70 > U \geq 40$	Cell C1	Cell C2	Cell C3	Cell C4	Cell C5
$40 > U \geq 5$	Cell D1	Cell D2	Cell D3	Cell D4	Cell D5
$U < 5$	Cell E1	Cell E2	Cell E3	Cell E4	Cell E5

5.2.9 Voltage swells

Voltage swells are typically caused by switching operations and load disconnections. Conventionally, the start threshold for swells is equal to the 110 % of the nominal voltage. Collected voltage swells are classified according to the following table.

Table 5.9: Voltage swell classification

Swell voltage	Duration (ms)		
	$10 \leq t \leq 500$	$500 < t \leq 5000$	$5000 < t \leq 60000$
$U \geq 120$	Cell A1	Cell A2	Cell A3
$120 > U > 110$	Cell B1	Cell B2	Cell B3

5.2.10 Short interruptions of the supply voltage

Under normal operating conditions the annual occurrence of short interruptions of the supply voltage ranges from up to a few tens to up to several hundreds. The duration of approximately 70 % of the short interruptions may be less than one second.

5.2.11 Long interruptions of the supply voltage

Under normal operating conditions the annual frequency of accidental voltage interruptions longer than three minutes may be less than 10 or up to 50 depending on the area.

5.2.12 Power Master recorder setting for EN 50160 survey

Power Master is able to perform EN 50160 surveys on all values described in previous sections. In order to simplify procedure, Power Master has predefined recorder configuration (EN 50160) for it. By default all current parameters (RMS, THD, etc.) are also included in survey, which can provide additional survey information. Additionally, during voltage quality survey user can simultaneously record other parameters too, such as power, energy and current harmonics.

In order to collect voltage events during recording, **Include events** option in recorder should be enabled. See section 3.19.2 for voltage events settings.

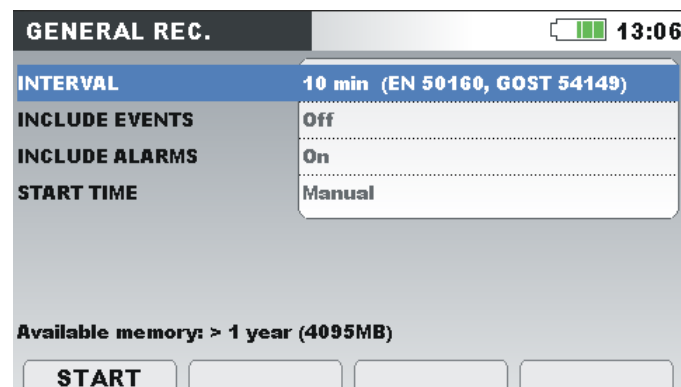

Figure 5.18: Predefined EN50160 recorder configuration

After recording is finished, EN 50160 survey is performed on PowerView v3.0 software. See PowerView v3.0 manual for details.

6 Technical specifications

6.1 General specifications

Working temperature range:	-10 °C ÷ +50 °C						
Storage temperature range:	-20 °C ÷ +70 °C						
Max. humidity:	95 % RH (0 °C ÷ 40 °C), non-condensing						
Pollution degree:	2						
Protection classification:	Reinforced insulation						
Measuring category:	CAT IV / 600 V; CAT III / 1000 V						
Protection degree:	IP 40						
Dimensions:	23 cm x 14cm x 8 cm						
Weight (with batteries):	0.96 kg						
Display:	Colour 4.3 TFT liquid crystal display (LCD) with backlight, 480 x 272 dots.						
Memory:	8 GB microSD card provided, max. 32 GB supported						
Batteries:	6 x 1.2 V NiMH rechargeable batteries type HR 6 (AA) Provide full operation for up to 4.5 hours*						
External DC supply - charger:	100-240 V~, 50-60 Hz, 0.4 A~, CAT II 300 V 12 V DC, min 1.2 A						
Maximum supply consumption:	12 V / 300 mA – without batteries 12 V / 1 A – while charging batteries						
Battery charging time:	3 hours*						
Communication:	<table border="1"> <tr> <td>USB 2.0</td> <td>Standard USB Type B</td> </tr> <tr> <td>RS-232</td> <td>8 pin PS/2 – type, 115200 baud</td> </tr> <tr> <td>Ethernet</td> <td>10Mb</td> </tr> </table>	USB 2.0	Standard USB Type B	RS-232	8 pin PS/2 – type, 115200 baud	Ethernet	10Mb
USB 2.0	Standard USB Type B						
RS-232	8 pin PS/2 – type, 115200 baud						
Ethernet	10Mb						

* The charging time and the operating hours are given for batteries with a nominal capacity of 2000 mAh.

6.2 Measurements

6.2.1 General description

Max. input voltage (Phase – Neutral):	1000 V _{RMS}
Max. input voltage (Phase – Phase):	1730 V _{RMS}
Phase - Neutral input impedance:	6 MΩ
Phase – Phase input impedance:	6 MΩ
AD converter	16 bit 8 channels, simultaneous sampling
Reference temperature	23 °C ± 2 °C
Temperature influence	60 ppm/°C

NOTE: Instrument has 3 internal voltage ranges. Range is chosen automatically, according to the set Nominal Voltage parameter. See tables below for details.

Nominal phase (L-N) voltage: U _{Nom}	Voltage range
50 V ÷ 136 V (L-N)	Range 1

137 V ÷ 374 V (L-N)	Range 2
375 V ÷ 1000 V (L-N)	Range 3

Nominal phase-to-phase (L-L) voltage: U_{Nom}	Voltage range
50 V ÷ 235 V (L-L)	Range 1
236 V ÷ 649 V (L-L)	Range 2
650V ÷ 1730 V (L-L)	Range 3

NOTE: Assure that all voltage clips are connected during measurement and logging period. Unconnected voltage clips are susceptible to EMI and can trigger false events. It is advisable to short them with instrument neutral voltage input.

6.2.2 Phase Voltages

10/12 cycle phase RMS voltage: U_{1Rms} , U_{2Rms} , U_{3Rms} , U_{NRms} , AC+DC

Measuring Range	Resolution*	Accuracy	Nominal Voltage range
10% U_{NOM} ÷ 150% U_{NOM}	10 mV, 100mV	$\pm 0.1 \% \cdot U_{NOM}$	50 ÷ 1000 V (L-N)

* - depends on measured voltage

Half cycle RMS voltage: $U_{1Rms(1/2)}$, $U_{2Rms(1/2)}$, $U_{3Rms(1/2)}$, $U_{1Min(1/2)}$, $U_{2Min(1/2)}$, $U_{3Min(1/2)}$, $U_{1Max(1/2)}$, $U_{2Max(1/2)}$, $U_{3Max(1/2)}$, AC+DC

Measuring Range	Resolution*	Accuracy	Nominal Voltage range
10% U_{NOM} ÷ 150% U_{NOM}	10 mV, 100mV	$\pm 0.2 \% \cdot U_{NOM}$	50 ÷ 1000 V (L-N)

* - depends on measured voltage

NOTE: Voltage events measurements are based on half cycle RMS voltage.

Crest factor: CF_{U1} , CF_{U2} , CF_{U3} , CF_{UN}

Measuring range	Resolution*	Accuracy
1.00 ÷ 2.50	0.01	$\pm 5 \% \cdot CF_U$

* - depends on measured voltage

Peak voltage: U_{1Pk} , U_{2Pk} , U_{3Pk} , AC+DC

Measuring range	Resolution*	Accuracy
Range 1: 20.00 ÷ 255.0 Vpk	10 mV, 100 mV	$\pm 0.5 \% \cdot U_{Pk}$
Range 2: 50.0 V ÷ 510.0 Vpk	10 mV, 100 mV	$\pm 0.5 \% \cdot U_{Pk}$
Range 3: 200.0 V ÷ 2250.0 Vpk	100 mV, 1V	$\pm 0.5 \% \cdot U_{Pk}$

* - depends on measured voltage

6.2.3 Line voltages

10/12 cycle line to line RMS voltage: U_{12Rms} , U_{23Rms} , U_{31Rms} , AC+DC

Measuring Range	Resolution*	Accuracy	Nominal Voltage range
10% U_{NOM} ÷ 150% U_{NOM}	10 mV, 100mV	$\pm 0.1 \% \cdot U_{NOM}$	50 ÷ 1730 V (L-L)

Half cycle RMS voltage (events): $U_{12Rms(1/2)}$, $U_{23Rms(1/2)}$, $U_{31Rms(1/2)}$, $U_{12Min(1/2)}$, $U_{23Min(1/2)}$, $U_{31Min(1/2)}$, $U_{12Max(1/2)}$, $U_{23Max(1/2)}$, $U_{31Max(1/2)}$, AC+DC

Measuring Range	Resolution*	Accuracy	Nominal Voltage range
10% U_{NOM} ÷ 150% U_{NOM}	10 mV, 100mV	$\pm 0.2 \% \cdot U_{NOM}$	50 ÷ 1730 V (L-L)

Crest factor: CF_{U21} , CF_{U23} , CF_{U31}

Measuring range	Resolution	Accuracy
1.00 ÷ 2.50	0.01	$\pm 5 \% \cdot CF_U$

Peak voltage: U_{12Pk} , U_{23Pk} , U_{31Pk} , AC+DC

Measuring range	Resolution	Accuracy
Range 1: 20.00 ÷ 422 Vpk	10 mV, 100 mV	$\pm 0.5 \% \cdot U_{Pk}$
Range 2: 47.0 V ÷ 884.0 Vpk	10 mV, 100 mV	$\pm 0.5 \% \cdot U_{Pk}$
Range 3: 346.0 V ÷ 3700 Vpk	100 mV, 1 V	$\pm 0.5 \% \cdot U_{Pk}$

6.2.4 Current

Input impedance: 100 k Ω

10/12 cycle RMS current I_{1Rms} , I_{2Rms} , I_{3Rms} , I_{NRms} , AC+DC.

Clamps	Range	Measuring range	Overall current accuracy
A 1281	1000 A	100 A ÷ 1200 A	$\pm 0.5 \% \cdot I_{RMS}$
	100 A	10 A ÷ 175 A	
	5 A	0.5 A ÷ 10 A	
	0.5 A	50 mA ÷ 1 A	
A 1227	3000 A	300 A ÷ 6000 A	$\pm 1.5 \% \cdot I_{RMS}$
	300 A	30 A ÷ 600 A	
	30 A	3 A ÷ 60 A	
A 1033	1000 A	20 A ÷ 1000 A	$\pm 1.3 \% \cdot I_{RMS}$
	100 A	2 A ÷ 100 A	
A 1122	5 A	100 mA ÷ 5 A	$\pm 1.3 \% \cdot I_{RMS}$

Note: Overall accuracy is calculated as:

$$\text{OverallAccuracy} = 1,15 \cdot \sqrt{\text{InstrumentAccuracy}^2 + \text{ClampAccuracy}^2}$$

Half cycle RMS current (inrush) $I_{1Rms1/2}$, $I_{2Rms1/2}$, $I_{3Rms1/2}$, $I_{NRms1/2}$, AC+DC

Clamps	Range	Measuring range	Overall current accuracy
A 1281	1000 A	100 A ÷ 1200 A	$\pm 0.5 \% \cdot I_{RMS}$
	100 A	10 A ÷ 175 A	
	5 A	0.5 A ÷ 10 A	
	0.5 A	50 mA ÷ 1 A	
A 1227	3000 A	300 A ÷ 6000 A	$\pm 1.5 \% \cdot I_{RMS}$
	300 A	30 A ÷ 600 A	
	30 A	3 A ÷ 60 A	
A 1033	1000 A	20 A ÷ 1000 A	$\pm 2.0 \% \cdot I_{RMS}$
	100 A	2 A ÷ 100 A	
A 1122	5 A	100 mA ÷ 10 A	$\pm 1.3 \% \cdot I_{RMS}$

Peak value I_{1Pk} , I_{2Pk} , I_{3Pk} , I_{NPK} , AC+DC

Measurement accessory		Peak value	Overall current accuracy
A 1281	1000 A	100 A ÷ 1700 A	$\pm 2.0 \% \cdot I_{RMS}$
	100 A	10 A ÷ 250 A	
	5 A	0.5 A ÷ 14 A	
	0.5 A	50 mA ÷ 1.4 A	
A 1227	3000 A	300 A ÷ 8500 A	$\pm 2.0 \% \cdot I_{RMS}$
	300 A	30 A ÷ 850 A	
	30 A	3 A ÷ 85 A	
A 1033	1000 A	20 A ÷ 1400 A	$\pm 3.0 \% \cdot I_{RMS}$
	100 A	2 A ÷ 140 A	
A 1122	5 A	100 mA ÷ 14 A	$\pm 3.0 \% \cdot I_{RMS}$

Crest factor CF_{Ip} p: [1, 2, 3, 4, N], AC+DC

Measuring range	Resolution	Accuracy
1.00 ÷ 10.00	0.01	$\pm 5 \% \cdot CF_I$

Accuracy of 10/12 cycle RMS voltage measured on current input

Measuring range (Intrinsic instrument accuracy)	Accuracy	Crest factor
Range 1: 10.0 mV _{RMS} ÷ 200.0 mV _{RMS}	$\pm 0.25 \% \cdot U_{RMS}$	1.5
Range 2: 50.0 mV _{RMS} ÷ 2.000 V _{RMS}		

U_{RMS} – RMS voltage measured on current input

Accuracy of half cycle RMS voltage measured on current input

Measuring range (Intrinsic instrument accuracy)	Accuracy	Crest factor
Range 1: 2.0 mV _{RMS} ÷ 200.0 mV _{RMS}	$\pm 1 \% \cdot U_{RMS}$	1.5
Range 2: 20.0 mV _{RMS} ÷ 2.0000 V _{RMS}	$\pm 1 \% \cdot U_{RMS}$	

6.2.5 Frequency

Measuring range	Resolution	Accuracy
50 Hz system frequency: 40.000 Hz ÷ 60.000 Hz 60 Hz system frequency: 50.000 Hz ÷ 70.000 Hz	2 mHz	± 10 mHz

6.2.6 Flickers

Flicker type	Measuring range	Resolution	Accuracy*
P_{inst}	0.200 ÷ 10.000	0.001	$\pm 5 \% \cdot P_{inst}$
P_{st}	0.200 ÷ 10.000		$\pm 5 \% \cdot P_{st}$
P_{lt}	0.200 ÷ 10.000		$\pm 5 \% \cdot P_{lt}$

6.2.7 Combined power

Combined Power	Measuring range		Accuracy
Active power* (W) P_1, P_2, P_3, P_{tot}	0.000 k ÷ 999.9 M 4 digits	Excluding clamps (Instrument only)	$\pm 0.2 \% \cdot P$
		With flex clamps A 1227 / 3000 A	$\pm 1.7 \% \cdot P$
		With iron clamps A 1281 / 1000 A	$\pm 0.7 \% \cdot P$
Nonactive power** (VAR) N_1, N_2, N_3, N_{tot}	0.000 k ÷ 999.9 M 4 digits	Excluding clamps (Instrument only)	$\pm 0.2 \% \cdot Q$
		With flex clamps A 1227 / 3000 A	$\pm 1.7 \% \cdot Q$
		With iron clamps A 1281 / 1000 A	$\pm 0.7 \% \cdot Q$
Apparent power*** (VA) S_1, S_2, S_3, S_{tot}	0.000 k ÷ 999.9 M 4 digits	Excluding clamps (Instrument only)	$\pm 0.5 \% \cdot Q$
		With flex clamps A 1227 / 3000 A	$\pm 1.8 \% \cdot S$
		With iron clamps A 1281 / 1000 A	$\pm 0.8 \% \cdot S$

*Accuracy values are valid if $\cos \varphi \geq 0.80$, $I \geq 10 \% I_{Nom}$ and $U \geq 80 \% U_{Nom}$

**Accuracy values are valid if $\sin \varphi \geq 0.50$, $I \geq 10 \% I_{Nom}$ and $U \geq 80 \% U_{Nom}$

***Accuracy values are valid if $\cos \varphi \geq 0.50$, $I \geq 10 \% I_{Nom}$ and $U \geq 80 \% U_{Nom}$

6.2.8 Fundamental power

Fundamental power	Measuring range		Accuracy
Active fundamental power* (W) $P_{fund1}, P_{fund2},$ P_{fund3}, P_{tot}^+	0.000 k ÷ 999.9 M 4 digits	Excluding clamps (Instrument only)	$\pm 0.2 \% \cdot P_{fund}$
		With flex clamps A 1227 / 3000 A	$\pm 1.7 \% \cdot P_{fund}$
		With iron clamps A 1281 / 1000 A	$\pm 0.7 \% \cdot P_{fund}$
Reactive fundamental power** (VAR) $Q_{fund1}, Q_{fund2},$ Q_{fund3}, Q_{tot}^+	0.000 k ÷ 999.9 M 4 digits	Excluding clamps (Instrument only)	$\pm 0.2 \% \cdot Q_{fund}$
		With flex clamps A 1227 / 3000 A	$\pm 1.7 \% \cdot Q_{fund}$
		With iron clamps A 1281 / 1000 A	$\pm 0.7 \% \cdot Q_{fund}$
Apparent fundamental power*** (VA)	0.000 k ÷ 999.9 M	Excluding clamps (Instrument only)	$\pm 0.2 \% \cdot S_{fund}$

Sfund ₁ , Sfund ₂ , Sfund ₃ , S ⁺ _{tot}	4 digits	With flex clamps A 1227 / 3000 A	±1.7 % · Sfund
		With iron clamps A 1281 / 1000 A	±0.7 % · Sfund

*Accuracy values are valid if $\cos \varphi \geq 0.80$, $I \geq 10 \% I_{Nom}$ and $U \geq 80 \% U_{Nom}$

**Accuracy values are valid if $\sin \varphi \geq 0.50$, $I \geq 10 \% I_{Nom}$ and $U \geq 80 \% U_{Nom}$

***Accuracy values are valid if $\cos \varphi \geq 0.50$, $I \geq 10 \% I_{Nom}$ and $U \geq 80 \% U_{Nom}$

6.2.9 Nonfundamental power

Nonfundamental power	Measuring range	Conditions	Accuracy
Active harmonic power* (W) Ph ₁ , Ph ₂ , Ph ₃ , Ph _{tot}	0.000 k ÷ 999.9 M 4 digits	Excluding clamps (Instrument only) Ph > 1% · P	±1.0% · Ph
Current distortion power* (VAr) D _{I1} , D _{I2} , D _{I3} , De _I ,	0.000 k ÷ 999.9 M 4 digits	Excluding clamps (Instrument only) D _I > 1% · S	±2.0 % · D _I
Voltage distortion power* (VAr) D _{V1} , D _{V2} , D _{V3} , De _V	0.000 k ÷ 999.9 M 4 digits	Excluding clamps (Instrument only) D _V > 1% · S	±2.0 % · D _V
Harmonics distortion power* (VAr) D _{H1} , D _{H2} , D _{H3} , De _H	0.000 k ÷ 999.9 M 4 digits	Excluding clamps (Instrument only) D _H > 1% · S	±2.0 % · D _H
Apparent nonfundamental power* (VA) S _{N1} , S _{N2} , S _{N3} , Se _N	0.000 k ÷ 999.9 M 4 digits	Excluding clamps (Instrument only) S _N > 1% · S	±1.0 % · S _N

Apparent harmonic power* (VA) $S_{H1}, S_{H2}, S_{H3}, S_{eH}$	0.000 k ÷ 999.9 M 4 digits	Excluding clamps (Instrument only) $S_H > 1\% \cdot S$	$\pm 2.0\% \cdot S_H$
---	-----------------------------------	--	-----------------------

*Accuracy values are valid if $I \geq 10\% I_{Nom}$ and $U \geq 80\% U_{Nom}$

6.2.10 Power factor (PF)

Measuring range	Resolution	Accuracy
-1.00 ÷ 1.00	0.01	± 0.02

6.2.11 Displacement factor (DPF) or Cos φ

Measuring range	Resolution	Accuracy
-1.00 ÷ 1.00	0.01	± 0.02

6.2.12 Energy

		Measuring range (kWh, kVAh, kVAh)	Resolution	Accuracy
Active energy E_p^*	Excluding clamps (Instrument only)	000,000,000.001 ÷ 999,999,999.999	12 digits	$\pm 0.5\% \cdot E_p$
	With A 1227 Flex clamps	000,000,000.001 ÷ 999,999,999.999		$\pm 1.8\% \cdot E_p$
	With A 1281 Multirange clamps 1000 A	000,000,000.001 ÷ 999,999,999.999		$\pm 0.8\% \cdot E_p$
	With A 1033 1000 A	000,000,000.001 ÷ 999,999,999.999		$\pm 1.6\% \cdot E_p$
Reactive energy E_q^{**}	Excluding clamps (Instrument only)	000,000,000.001 ÷ 999,999,999.999	12 digits	$\pm 0.5\% \cdot E_q$
	With A 1227 Flex clamps	000,000,000.001 ÷ 999,999,999.999		$\pm 1.8\% \cdot E_q$
	With A 1281 Multirange clamps 1000 A	000,000,000.001 ÷ 999,999,999.999		$\pm 0.8\% \cdot E_q$
	With A 1033 1000 A	000,000,000.001 ÷ 999,999,999.999		$\pm 1.6\% \cdot E_q$

*Accuracy values are valid if $\cos \varphi \geq 0.80$, $I \geq 10\% I_{Nom}$ and $U \geq 80\% U_{Nom}$

**Accuracy values are valid if $\sin \varphi \geq 0.50$, $I \geq 10\% I_{Nom}$ and $U \geq 80\% U_{Nom}$

6.2.13 Voltage harmonics and THD

Measuring range	Resolution	Accuracy
$U_{hN} < 1\% U_{Nom}$	10 mV	$\pm 0.15\% \cdot U_{Nom}$
$1\% U_{Nom} < U_{hN} < 20\% U_{Nom}$	10 mV	$\pm 5\% \cdot U_{hN}$

U_{Nom} : Nominal voltage (RMS)

U_{hN} : measured harmonic voltage
 N : harmonic component $0^{\text{th}} \div 50^{\text{th}}$

Measuring range	Resolution	Accuracy
$0 \% U_{\text{Nom}} < \text{THD}_U < 20 \% U_{\text{Nom}}$	0.1 %	± 0.3

U_{Nom} : nominal voltage (RMS)

6.2.14 Current harmonics and THD

Measuring range	Resolution	Accuracy
$I_{hN} < 10 \% I_{\text{Nom}}$	10 mV	$\pm 0.15 \% \cdot I_{\text{Nom}}$
$10 \% I_{\text{Nom}} < I_{hN} < 100 \%$	10 mV	$\pm 5 \% \cdot I_{hN}$

I_{Nom} : Nominal clamp current (RMS)

I_{hN} : measured harmonic current

N : harmonic component $0^{\text{th}} \div 50^{\text{th}}$

Measuring range	Resolution	Accuracy
$0 \% I_{\text{Nom}} < \text{THD}_I < 100 \% I_{\text{Nom}}$	0.1 %	± 0.6
$100 \% I_{\text{Nom}} < \text{THD}_I < 200 \% I_{\text{Nom}}$	0.1 %	± 0.3

I_{Nom} : Nominal current (RMS)

6.2.15 Voltage interharmonics

Measuring range	Resolution	Accuracy
$U_{ihN} < 1 \% U_{\text{Nom}}$	10 mV	$\pm 0.15 \% \cdot U_{\text{Nom}}$
$1 \% U_{\text{Nom}} < U_{ihN} < 20 \% U_{\text{Nom}}$	10 mV	$\pm 5 \% \cdot U_{ihN}$

U_{Nom} : nominal voltage (RMS)

U_{ihN} : measured harmonic voltage

N : interharmonic component $0^{\text{th}} \div 50^{\text{th}}$

6.2.16 Current interharmonics

Measuring range	Resolution	Accuracy
$I_{ihN} < 10 \% I_{\text{Nom}}$	10 mV	$\pm 0.15 \% \cdot I_{\text{Nom}}$
$10 \% I_{\text{Nom}} < I_{ihN} < 100 \%$	10 mV	$\pm 5 \% \cdot I_{ihN}$

I_{Nom} : Nominal current (RMS)

I_{ihN} : measured interharmonic current

N : interharmonic component $0^{\text{th}} \div 50^{\text{th}}$

6.2.17 Signalling

Measuring range	Resolution	Accuracy
$1 \% U_{\text{Nom}} < U_{\text{Sig}} < 3 \% U_{\text{Nom}}$	10 mV	$\pm 0.15 \% \cdot U_{\text{Nom}}$
$3 \% U_{\text{Nom}} < U_{\text{Sig}} < 20 \% U_{\text{Nom}}$	10 mV	$\pm 5 \% \cdot U_{\text{Sig}}$

U_{Nom} : Nominal current (RMS)

U_{Sig} : Measured signalling voltage

6.2.18 Unbalance

	Unbalance range	Resolution	Accuracy
u^-	$0.5 \% \div 5.0 \%$	0.1 %	$\pm 0.15 \% \cdot u^-$

u^0			$\pm 0.15 \% \cdot u^0$
i^-	0.0 % ÷ 20 %	0.1 %	$\pm 1 \% \cdot i^-$
i^0			$\pm 1 \% \cdot i^0$

6.2.19 Time and duration uncertainty

Real time clock (RTC) uncertainty

Operating range	Accuracy	
-20 °C ÷ 70 °C	± 3.5 ppm	0.3 s/day
0 °C ÷ 40 °C	± 2.0 ppm	0.17 s/day

Event duration and recorder time-stamp and uncertainty

	Measuring Range	Resolution	Error
Event Duration	10 ms ÷ 7 days	1 ms	± 1 cycle

6.2.20 Temperature probe

Measuring range	Resolution	Accuracy
-10.0 °C ÷ 85.0 °C	0.1 °C	± 0.5°C
-20.0 °C ÷ -10.0 °C and 85.0 °C ÷ 125.0 °C		± 2.0°C

6.3 Recorders

6.3.1 General recorder

Sampling	5 readings per second, continuous sampling per channel. All channels are sampled simultaneously. Sampling frequency is continuously synchronized with main frequency.
Recording quantities	Voltage, current, frequency, crest factors, power, energy, 50 harmonics, 50 interharmonics, flickers, signalling, unbalance. See section 4.4 for details which minimum, maximum, average and active average values are stored for each parameter.
Recording interval	1 s, 3 s, 5 s, 10 s, 1 min, 2 min, 5 min, 10 min, 15 min, 30 min, 60 min.
Events	All events, without limitation can be stored into record.
Alarms	All alarms, without limitation can be stored into record.
Trigger	Start time or manual.

Table 6.1: General recording max. duration

Recording interval	microSD card size		
	8 GB	16 GB	32 GB
	Max. record duration*		
1 s	2 days 17 h	5 days 7 h	10 days 22 h
3 s	8 days 3 h	15 days 23 h	32 days 18 h
5 s	13 days 14 h	26 days 15 h	54 days 15 h
10 s	27 days 4 h	53 days 6 h	109 days 6 h
1 min	163 days 3 h	319 days 14 h	> 1 year
2 min	326 days 7 h	> 1 year	> 1 year
5 min	> 1 year	> 1 year	> 1 year
10 min	> 1 year	> 1 year	> 1 year
15 min	> 1 year	> 1 year	> 1 year
30 min	> 1 year	> 1 year	> 1 year
60 min	> 1 year	> 1 year	> 1 year

*Complete memory is erased before recording.

6.3.2 Waveform/inrush recorder

Sampling	102.4 samples per cycle period at 50/60 Hz mains frequency, continuous sampling per channel. All channels are sampled simultaneously. Sampling frequency is continuously synchronized with mains frequency.
Recording time	From 1 sec to 60 seconds.
Recording type	Single – waveform recording ends after first trigger. Continuous – consecutive waveform recording until user stops the measurement or instrument runs out of storage memory. Max. 200 records can be stored per session.
Recording quantities	Waveform samples of: $U_1, U_2, U_3, U_N, (U_{12}, U_{23}, U_{31}), I_1, I_2, I_3, I_N$

Trigger	Voltage or current level, voltage events, alarms defined in alarm table or manual trigger.
---------	--

6.3.3 Waveform snapshot

Sampling	102.4 samples per cycle at 50/60 Hz mains frequency. All channels are sampled simultaneously.
Recording time	10 cycle period.
Recording quantities	Waveform samples of: $U_1, U_2, U_3, U_N, (U_{12}, U_{23}, U_{31}), I_1, I_2, I_3, I_N$, all measurements.
Trigger	Manual

6.3.4 Transients recorder

Sampling	1024 samples per cycle at 50/60 Hz mains frequency. All channels are sampled simultaneously.
Recording time	From 1 ÷ 50 cycle period.
Recording quantities	Waveform samples of: $U_1, U_2, U_3, U_N, (U_{12}, U_{23}, U_{31}), I_1, I_2, I_3, I_N$ Calculated for all channels: $U_{RMS}, I_{RMS}, THDU, THDI$
Trigger:	Manual, dV - for detail see section 5.1.16

6.4 Standards compliance

6.4.1 Compliance to the IEC 61557-12

General and essential characteristics

Power quality assessment function	-S
Classification according to 4.3	SD Indirect current and direct voltage measurement
	SS Indirect current and indirect voltage measurement
Temperature	K50
Humidity + altitude	Standard

Measurement characteristics

Function symbols	Class according to IEC 61557-12	Measuring range
P	1	2 % ÷ 200% $I_{Nom}^{(1)}$
Q	1	2 % ÷ 200% $I_{Nom}^{(1)}$
S	1	2 % ÷ 200% $I_{Nom}^{(1)}$
Ep	1	2 % ÷ 200% $I_{Nom}^{(1)}$
Eq	2	2 % ÷ 200% $I_{Nom}^{(1)}$
eS	1	2 % ÷ 200% $I_{Nom}^{(1)}$
PF	0.5	- 1 ÷ 1
I, I_{Nom}	0.2	2 % I_{Nom} ÷ 200 % I_{Nom}
I_{hn}	1	0 % ÷ 100 % I_{Nom}
THDi	2	0 % ÷ 100 % I_{Nom}

(1) – Nominal current depends on current sensor.

6.4.2 Compliance to the to the IEC 61000-4-30

IEC 61000-4-30 Section and Parameter	Power Master Measurement	Class
4.4 Aggregation of measurements in time intervals		A
4.6 Real time clock (RTC) uncertainty		A
5.1 Frequency	Freq	A
5.2 Magnitude of the Supply	U	A
5.3 Flicker	P_{st}, P_{It}	A
5.4 Dips and Swells	$U_{Dip}, U_{Swell}, \text{duration}$	A
5.5 Interruptions	duration	A
5.7 Unbalance	u^-, u^0	A
5.8 Voltage Harmonics	$U_{h_{0+50}}$	A
5.9 Voltage Interharmonics	$U_{ih_{0+50}}$	A
5.10 Mains signalling voltage	U_{Sig}	A

7 Maintenance

7.1 Inserting batteries into the instrument

1. Make sure that the power supply adapter/charger and measurement leads are disconnected and the instrument is switched off before opening battery compartment cover (see *Figure 2.4*).
2. Insert batteries as shown in figure below (insert batteries correctly, otherwise the instrument will not operate and the batteries could be discharged or damaged).



Figure 7.1: Battery compartment

<u>1</u>	<u>Battery cells</u>
<u>2</u>	<u>Serial number label</u>

3. Turn the instrument upside down (see *figure below*) and put the cover on the batteries.



Figure 7.2: Closing the battery compartment cover

4. Screw the cover on the instrument.

⚠ Warnings!

- **Hazardous voltages exist inside the instrument. Disconnect all test leads, remove the power supply cable and turn off the instrument before removing battery compartment cover.**
- **Use only power supply adapter/charger delivered from manufacturer or distributor of the equipment to avoid possible fire or electric shock.**
- **Do not use standard batteries while power supply adapter/charger is connected, otherwise they may explode!**
- **Do not mix batteries of different types, brands, ages, or charge levels.**
- **When charging batteries for the first time, make sure to charge batteries for at least 24 hours before switching on the instrument.**

Notes:

- Rechargeable NiMH batteries, type HR 6 (size AA), are recommended. The charging time and the operating hours are given for batteries with a nominal capacity of 2000 mAh.
- If the instrument is not going to be used for a long period of time remove all batteries from the battery compartment. The enclosed batteries can supply the instrument for approx. 4.5 hours.

7.2 Batteries

Instrument contains rechargeable NiMH batteries. These batteries should only be replaced with the same type as defined on the battery placement label or in this manual. If it is necessary to replace batteries, all six have to be replaced. Ensure that the batteries are inserted with the correct polarity; incorrect polarity can damage the batteries and/or the instrument.

Precautions on charging new batteries or batteries unused for a longer period

Unpredictable chemical processes can occur during charging new batteries or batteries that were unused for a longer period of time (more than 3 months). NiMH and NiCd

batteries are affected to a various degree (sometimes called as memory effect). As a result the instrument operation time can be significantly reduced at the initial charging/discharging cycles.

Therefore it is recommended:

- To completely charge the batteries
- To completely discharge the batteries (can be performed with normal working with the instrument).
- Repeating the charge/discharge cycle for at least two times (four cycles are recommended).

When using external intelligent battery chargers one complete discharging /charging cycle is performed automatically.

After performing this procedure a normal battery capacity is restored. The operation time of the instrument now meets the data in the technical specifications.

Notes

The charger in the instrument is a pack cell charger. This means that the batteries are connected in series during the charging so all batteries have to be in similar state (similarly charged, same type and age).

Even one deteriorated battery (or just of another type) can cause an improper charging of the entire battery pack (heating of the battery pack, significantly decreased operation time).

If no improvement is achieved after performing several charging/discharging cycles the state of individual batteries should be determined (by comparing battery voltages, checking them in a cell charger etc). It is very likely that only some of the batteries are deteriorated.

The effects described above should not be mixed with normal battery capacity decrease over time. All charging batteries lose some of their capacity when repeatedly charged/discharged. The actual decrease of capacity versus number of charging cycles depends on battery type and is provided in the technical specification of batteries provided by battery manufacturer.

7.3 Power supply considerations

Warnings

- **Use only charger supplied by manufacturer.**
- **Disconnect power supply adapter if you use standard (non-rechargeable) batteries.**

When using the original power supply adapter/charger the instrument is fully operational immediately after switching it on. The batteries are charged at the same time, nominal charging time is 2.5 hours.

The batteries are charged whenever the power supply adapter/charger is connected to the instrument. Inbuilt protection circuit controls the charging procedure and assure maximal battery lifetime.

If the instrument is left without batteries and charger for more than 2 minutes, time and date settings are reset.

7.4 Cleaning

To clean the surface of the instrument use a soft cloth slightly moistened with soapy water or alcohol. Then leave the instrument to dry totally before use.



Warnings

- Do not use liquids based on petrol or hydrocarbons!
- Do not spill cleaning liquid over the instrument!

7.5 Periodic calibration

To ensure correct measurement, it is essential that the instrument is regularly calibrated. If used continuously on a daily basis, a six-month calibration period is recommended, otherwise annual calibration is sufficient.

7.6 Service

For repairs under or out of warranty please contact your distributor for further information.

7.7 Troubleshooting

If *ESC* button is pressed while switching on the instrument, the instrument will not start. Batteries have to be removed and inserted back. After that the instrument will start normally.

Manufacturer address:

METREL d.d.
Ljubljanska 77,
SI-1354 Horjul,
Slovenia

Tel: +(386) 1 75 58 200
Fax: +(386) 1 75 49 095
Email: metrel@metrel.si
<http://www.metrel.si>