

MK350D User Manual and Warranty 使用說明書與保固手冊 使用說明書び保証書

- * To ensure your warranty validation, please place your agent's stamp in the box and fill in the purchase date. If the agent stamp and purchase date cannot be supplied, the warranty period will be based on the manufacturing date of the product.
- * 為確保您的權益，請要求經銷商蓋上店章及填寫購買日期；未蓋店章與購買日期者，則以出廠日期為依據。
- * お客様の権利を確保するために、販売店に店の印章または、購入日を記入することを依頼してください。販売店の印章または購入日のない場合、製造日に基づいて取り扱いいたします。

Original / Authorized Agent Stamp

Product Serial Number : _____

Purchase Date : _____

V 1.0



LED Meter · LED 光譜計 · LED メーター

UPRtek 群耀科技股份有限公司
United Power Research Technology Corporation

TEL : +886-37-580885 FAX : +886-37-580398 Website : www.uprtek.com
Address : No.38, Keyi St., Zhunan Township, Miaoli County 35059, Taiwan

The information contained herein is the exclusive property and confidential document of United Power Research Technology Corporation, and shall not be distributed, reproduced or disclosed in whole or in part without prior written permission of United Power Research Technology Corporation.

Contents

1	Introduction.....	1
	1.1 Features.....	2
	1.2 Package Contents.....	3
	1.3 Product Description.....	4
	1.4 Annual Product Calibration	5
	1.5 Product Notes and Precautions.....	6
2	Getting Started.....	7
	2.1 Product Setup	8
	2.2 Taking a Measurement.....	10
	2.3 Product Registration.....	14
3	Additional Setup and Notes.....	15
	3.1 MicroSD Card.....	16
	3.2 Setting the Date / Time.....	17
	3.3 More about Dark Calibration.....	18
4	Miscellaneous.....	19
	4.1 Tripod Attachment.....	20
	4.2 System Reset.....	21
	4.3 uSPECTRUM PC / Smart Device APPs.....	22
5	Specification.....	23
6	Warranty.....	27
7	Warning Statement.....	32
	7.1 NCC Warning Statement.....	33
	7.2 FCC Warning Statement.....	34

Introduction

- 
-
- 1.1 Features
 - 1.2 Package Contents
 - 1.3 Product Description
 - 1.4 Annual Product Calibration
 - 1.5 Product Notes and Precautions

1.1 Features

The MK350D is a lightweight, portable, easy-to-operate LED meter with Bluetooth remote control operations and Micro SD Card data storage. This product has basic features for fast, easy Light Measurements.

- 70g pocket size, the lightest handheld spectrometer in the world.
- Flicker measurement for disease prevention and health check.
- Standalone operation, no need smart phone or PC connection.
- Supports Micro SD card, unlimited data storage for measurement.
- Spectrum diagram and including 27 light unit-of-measure.
- Compatible with smart device, wireless controlled by Bluetooth.
- Additional uSPECTRUM App and Software for advance analysis.

1.2 Package Contents

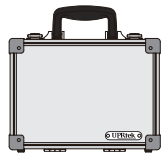

Case



MK350D LED Meter



Protection Bag



uSPECTRUM PC Software
Serial Number Register Card



USB Cable



Power Adaptor



User Manual
and Warranty



Neck Strap Screw



Neck Strap

1.3 Product Description

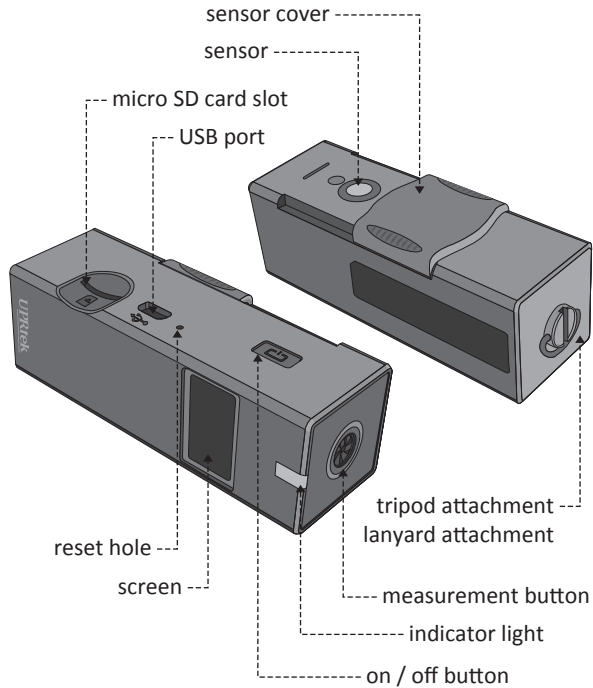

1.4 Annual Product Calibration

This product is a high-precision measurement device with sensitive components – please handle with care. To ensure the accuracy of measurements, it is recommended to have the unit calibrated once a year. Please contact your agent or our customer service department for calibration service.

1.5 Product Notes and Precautions

The MK350D LED Meter contains sensitive components. Please unpack with care, as any trauma to the unit may damage the equipment. Contact your agent if the unit appears not to be operating normally. Do not attempt any repairs – all repairs must be performed by qualified service agents.



Precautions / Warnings

Please read the following precautions to avoid fire, excessive heat, chemical leakage and explosion.

- Do not disassemble or modify the battery.
- Do not expose the battery to heat (fire) or water/moisture.
- If the unit is plugged into the power adapter and the battery seems to be overheating, or if there is smoke or peculiar odors emanating from the unit, unplug immediately to avoid the possibility of fire.
- However, do not touch the cables if there is heat emanating from near the cables as melted or deformed cables could expose wiring and result in burns or electric shock.
- Do not use cloth or anything to wrap or cover the equipment while charging – this could cause the unit to overheat, melting the casing or causing fire.
- If the unit is accidentally immersed in water, or if moisture has seeped inside, or metal objects have dropped into the casing, immediately remove the battery to avoid fire or electric shock.
- Do not operate or store the battery in high-temperature environments - it will cause battery leakage and/or shorten the life of the battery .
- Do not use paint thinner, benzene or other organic solvents to clean the equipment– this may damage the exterior finish or touch screen, and may even ignite fire.

Getting Started



2.1 Product Setup

2.2 Taking a Measurement

2.3 Product Registration

2.1 Product Setup

1. Charging the internal battery

Remove the MK350D unit and the USB Charger supplied in the packaging and connect one end of the Charger cable to the MK350D and the other end into a wall socket with the appropriate voltage. The indicator light will illuminate orange indicating that it is charging. The light will turn green when fully charged. For first time use, charge the battery for at least 6 hours.

The indicator light will light up in orange, and the light becomes green after fully.



If the unit is charging, a lightning bolt will appear over the battery symbol charged.

2.1 Product Setup

2. Lanyard strap



You can attach a lanyard (neck strap) onto the ring at the bottom of the MK350D.

2.2 Taking a Measurement



Slide the “Sensor Cover” over the sensor lens.



Then turn on the MK350D by pressing the On/Off button on the side of the unit. The indicator light will illuminate green and a UPRtek splash screen will display.

Note : If you are using a USB Charger, the MK350D will automatically turn itself on.



After the splash screen, a Dark Calibration label will display indicating that a Dark Calibration is in progress.

2.2 Taking a Measurement



When Dark Calibration is complete, the screen will indicate.



Slide the Sensor Cover so that the Sensor is visible again.



The first screen will display the Date & Time, Optic Number and Version Number. The battery level indicator is on the right.

2.2 Taking a Measurement



Hold the MK350D as shown with the Sensor facing toward the front, in the direction of a light source and press the “Measure” button at the top of MK350D.



After which it will respond with a beep to indicate completion.

The screen will display CCT, CRI, LUX and LambdaP.

Note : you may get a message that the Micro SD Card is not installed – disregard this message for now.



Press the On/Off button once to go to the next screen. The next screen shows the Wavelength Spectrum.

2.2 Taking a Measurement

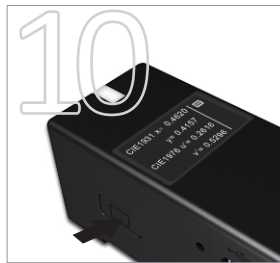

Press the On/Off button once to go to the next screen. The next screen shows the CIE 1931 x, y coordinates and the CIE 1976 u', v' coordinates.



Press the On/Off button once to go to the next screen. The next screen shows the R9 value, LUX value, FC (foot candle) value and the Percentage Flicker.



1. While your unit is charging, you can start taking measurements with the power adaptor plugged in or you can wait until the unit is fully charged.
2. To turn off the MK350D, press the On / Off button and keep it depressed for at least 3 seconds.

2.3 Product Registration

At this point, please register your product at our website to ensure maximum warranty and service benefits.

1. When you initially turn on the MK350D, it will display the Optic number (OPT:).
2. Write down the Optic number and, using a PC, access <http://www.uprtek.com>, and go to “Support → Extended Warranty”.
3. Follow the directions on the screen to complete the registration – a successful registration will provide you with a license file, which you can place on a MicroSD card.
4. After the card is inserted into your MK350D, the license will be auto-applied to the MK350D and the Version Number (below the Opt number) will show “-CCS”.

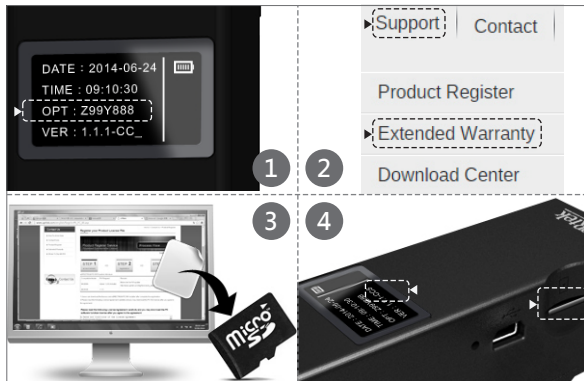

Additional Setup and Notes

3.1 MicroSD Card

3.2 Setting the Date / Time

3.3 More about Dark Calibration

3.1 MicroSD Card

This unit can write LED measurement data onto a MicroSD Card (only support for above 1GB / up to 32G). Simply insert the card into the MicroSD card slot. All data that is captured is written to excel files (.xls).



Even without a MicroSD Card, the MK350D is able to capture data .

You can read the data via Micro SD card reader and find the data on the SD Card under the "Data" directory. There will be subdirectories marked with a sequential number "e.g. 0001". Each directory can hold up to 100 capture files, after which the next sequential subdirectory will be created (e.g. 0002).



Each capture will be contained in its own Excel file with a naming convention of ESPD_XXXX, where XXXX is a sequential number (e.g. 0001, 0002).

Additional data such as Integration Time, R1-R15, LambdaPV and all of the intensity data in the Wavelength

Spectrum are all available in the file.

3.2 Setting the Date/Time on your MK350D

By plugging your MK350D connection to uSPECTRUM PC software using the USB cable supplied, the MK350D will automatically sync up its Date / Time from the PC.

The Date / Time will also sync from a smart device if you use the smart device to make a Bluetooth connection to the MK350D.

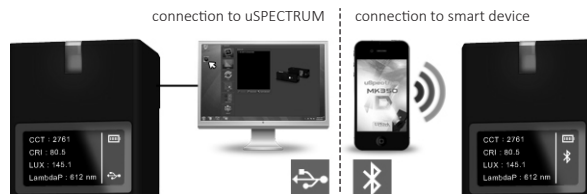

3.3 More about Dark Calibration

It is good practice to perform a dark calibration every time you turn on the MK350D, when you move to a different temperature environment (hot to cold or cold to hot), or when you move to a different light intensity environment (light to dark or dark to light).

You also can use PC software or smart device APPs to do dark calibration.

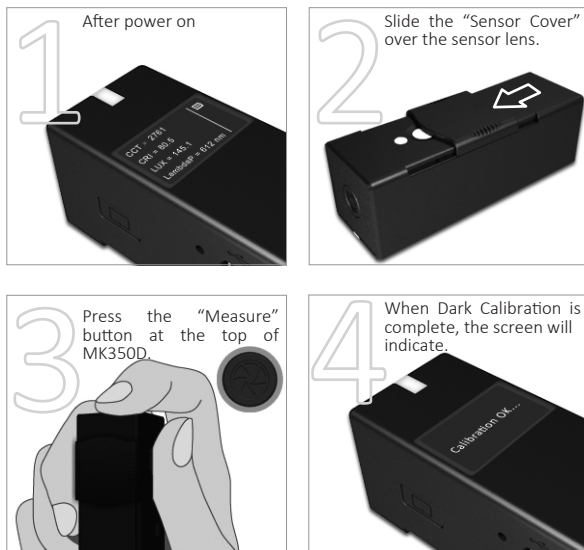

Miscellaneous

4

4.1 Tripod Attachment

4.2 System Reset

4.3 uSPECTRUM PC / Smart Device APPs

4.1 Tripod Attachment

If you detach the lanyard screw on the bottom of the MK350D, it will expose a screw hole where you can attach a tripod for hands-free LED measurements.



4.2 System Reset

If for any reason you need to perform a system reset, you can use a pointer to press into the Reset Hole as shown right.



4.3 uSPECTRUM PC/Smart Device APPs

The MK350D can also interface with a PC using the uSPECTRUM PC Software, which provides a much richer functional and visual environment.

To obtain the uSPECTRUM software, you must go to www.uprtek.com.

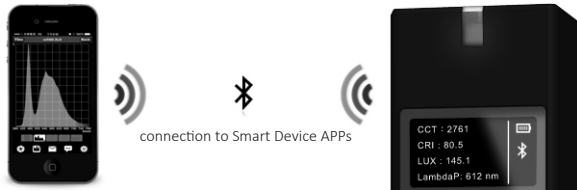
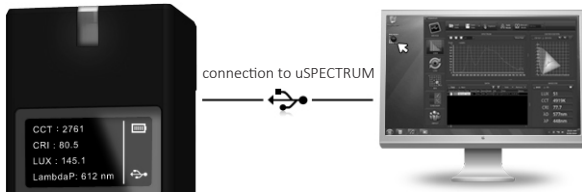

The MK350D can also be remote controlled by an Apple IOS or Android smart device, using a Bluetooth connection.

Specifications

5

Sensor	CMOS linear image sensor
Spectral Bandwidth	Approximately 12 nm (half bandwidth)
Receptor Size	Ø 6.6 ± 0.1 mm
Cosine Correction	refer Figure 1.
Measurement Range	70 ~ 70000 Lux
Wavelength Range	380 ~ 780 nm
Integration Time Range	6 ~ 1000 ms
Operation Mode	Standalone Mode / Bluetooth Mode / USB Mode
Capture Function	One time / Continuous (Standalone mode only support One time)
Integration Mode	Auto / Manual (Standalone mode only support Auto)
Standalone Screen Display	1. CCT, CRI, LUX, λ P 2. Spectrum Graphics
Data Measurements	3. CIE 1931 / CIE 1976 U.C.S Chromaticity Value 4. R9, LUX, FC, Flicker
Measurement Data Collected and Saved to MicroSD Card	1. CCT 2. CRI (R1-R15) 3. LUX 4. λ P 5. C.I.E. Chromaticity Coordinates (1) CIE 1931 x,y Coordinates (2) CIE 1976 U.C.S u',v' Coordinates 6. Percentage Flicker
Digital Resolution	16 bits
Dark Calibration	Yes
Stray Light	-25 dB max. ^{*1}

Wavelength Data Increment	1 nm	
Wavelength Reproducibility	± 1 nm ⁻²	
Illuminance Accuracy	Illuminant A @ 2856K at 20000 Lux	± 5%
Color Accuracy		± 0.0025 in CIE 1931 x,y
Color Repeatability		± 0.0005 in CIE 1931 x,y
CCT Accuracy		± 2%
CRI Accuracy @ Ra		± 1.5%
Percentage Flicker	1 ~ 100 %	
Flicker Frequency	10 ~ 165 Hz	
Flicker Accuracy	± 5%	
Display	0.96" 128x64 mono OLED Panel	
Bluetooth	3.0 / 4.0 compatible with iOS and Android	
Max. Files	≈ 2000 Files @ 2GB SD Card	
Battery Operation Time	≤ 3 hours / Fully Charged	
Battery	700 mAh / Rechargeable Li-ion Battery	
Data Output Interface	MicroSD Card (SD2.0, SDHC / above 1GB-up to 32G) / Mini USB Port (USB 2.0)	
Data Format	Compatible MicroSoft Office Excel	
Dimensions	33 x 33 x 90 mm (H x W x D)	
Weight (with Battery)	70 g ± 5 g	
Operating Temperature	0 ~ 35 °C	
Storage Temperature	-10 ~ 40 °C	
Language Selection	English / Traditional Chinese / Simplified Chinese / Japanese / German / French / Russian / Spanish / Italian (Standalone mode only support English)	

*1 : Use the input of 550nm single-frequency and measurement the range of optical ± 40 nm.

*2 : Input source must be a stable light source.

The company reserves the right to change product specifications, if it has any changes will not give any notice.

Figure 1 : Cosine Correction

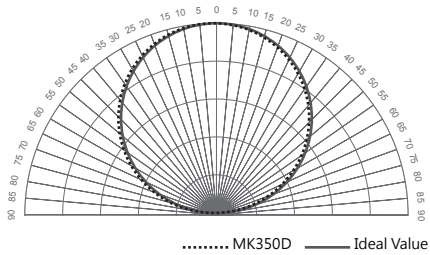

Warranty

6

Warranty Policy

UPRtek provides replacement or repair services to our customers for defective products within the applicable warranty period.

1. DOA (Dead on Arrival) Returns :

- In the event that you receive a product that is not working properly or is defective, you should notify our service staff upon receipt of the products. If defects in the product are discovered within 7 days after receiving the product (except those due to willful damage or customer misuse), you should notify us by email, facsimile, or phone immediately upon noticing the defect, so we can process the return as a DOA product. You will be issued a DOA number accordingly.
- DOA products must be returned within 30 days of purchase and in original condition. For products considered as “Dead on Arrival”, we will replace it with a new product (in whole package) at no charge and pay return and re-delivery shipping costs. International customers should allow for additional transit time due to international customs clearance.

2. RMA (Return Merchandise Authorization) :

- For merchandise sent for repair or replacement with or without warranty, you must first obtain an RMA number by contacting our service staff by mail. The following information is required in order to complete your RMA request: company name, contact person, phone number and e-mail, customer ship-to address, product model number, serial number, and a brief description of the problem you are experiencing with the product you wish to return.
- All returned products will be tested by our professional technicians to verify the complaint / defect in question. However, if the defect in question cannot be found by our technicians, you are responsible for paying a testing fee plus shipping fee for NDF(No-Defect Found) products.
- Claims for loss or damage during shipment must be made to the courier by the customer. For your protection, we strongly recommend that you fully

insure your return shipment for damages. Please use a courier that is able to provide you with proof of delivery.

Limitation of Warranty

Please note that UPRtek is not responsible for providing repairs under warranty if the product defect is caused by any of the following factors :

1. Damage caused by natural calamity or any inappropriate usage.
2. Product has been repaired or taken apart by unauthorized technicians.
3. The warranty label is altered, damaged or missing.
4. Product serial number does not conform to our original system or the label has been damaged.

Disclaimer

- UPRtek shall in no event be liable for any defect, damage or data loss that has occurred during the delivery of in-warranty products. Prior to claiming warranty service, UPRtek recommends that you make a backup of your data and remove your data from in-warranty products.
- Under the maximum allowable range of applicable laws and regulations, any business loss, expected cost loss, data disappearance, or any other indirect, accidental, or derived loss or damages due to the utilization of or related to the company product, shall not be the responsibility of UPRtek for any compensation.

Customers Eligible for Warranty Service

UPRtek warranty policy applies to all customers who purchased from either UPRtek or through authorized agents of UPRtek.

Duration of Warranty

1. MK350 HOST :

The MK350 LED METER series all come with 2-year product warranty.

2. Accessories :

UPRtek RMA policy is only for LED Meter repair and does not cover maintenance or calibration services (aside from one time free calibration on warranty). The policy also does not cover accessories like tripods and straps, nor does it cover consumable items like batteries.

Authorized Distributor/Dealer Services

- **Product-based functional testing** - Performed by distributors and dealers to determine whether the product needs to be returned to the factory for further calibration services or technical repairs (All UPRtek authorized distributors/dealers have a right to perform “Product-based functional testing” for a reasonable charge).
- **RMA product delivery to and from factory** - Distributors/dealers can assist customers in sending/receiving RMA products to/from the UPRtek factory.
- Authorized distributors/dealers are listed on our website : www.uprtek.com

Additional Remarks

Product parts and components are not always manufactured by UPRtek. On occasion, these 3rd party components may need to be replaced but are already discontinued by the supplier. In this case, UPRtek assures customers that it will fulfill its repair and replacement responsibilities by using substitute parts or components of equal level and quality.

Delivery Methods

Consumers can choose either of the two methods indicated below to return the product to the factory for RMA Service :

- Customers can send the products through UPRtek global distribution channels that will send and return the products to and from the factory for repair and warranty service.

- Customers can return the product directly to the UPRtek factory for servicing.

Rules on Product Repairs After The Warranty Period

UPRtek provides product services after warranty expiration at reasonable charges. In case of product defects, the customers are still able to send products back to the UPRtek factory for service. The repair charges will be based on the type of defect, and in some cases, maintenance fees will be charged.

However, purchasing a new product is advised under these conditions:

- If the MK350 series or its accessories are no longer available.
- If the product functionality is almost certain to be impossible to recover from (e.g. total immersion in water, undergoing extreme electrical shock, severe contamination or corrosion damage).
- If the product was dropped or sustained such a traumatic impact causing major structural damage, or if our technicians determine that normal functionality cannot be recovered even after major component replacement.
- If multiple parts simultaneously fail due to normal wear and tear, or poor handling.
- Even if the product is within the service period of the warranty, yet parts are no longer available.

Warning Statement

7

7.1 NCC Warning Statement

7.2 FCC Warning Statement

7.1 NCC Warning Statement

Article 12

Without permission, any company, firm or user shall not alter the frequency, increase the power, or change the characteristics and functions of the original design of the certified lower power frequency electric machinery.

Article 14

The application of low power frequency electric machineries shall not affect the navigation safety nor interfere a legal communication, if an interference is found, the service will be suspended until improvement is made and the interference no longer exists.

7.2 FCC Warning Statement

a. for FCC 15b devices (15.105)

This equipment has been tested and found to comply with the limits for a Class B digital device, pursuant to part 15 of the FCC rules. These limits are designed to provide reasonable protection against harmful interference in a residential installation. This equipment generates, uses and can radiate radio frequency energy and, if not installed and used in accordance with the instructions, may cause harmful interference to radio communications. However, there is no guarantee that interference will not occur in a particular installation. If this equipment does cause harmful interference to radio or television reception, which can be determined by turning the equipment off and on, the user is encouraged to try to correct the interference by one or more of the following measures:

- Reorient or relocate the receiving antenna.
- Increase the separation between the equipment and receiver.
- Connect the equipment into an outlet on a circuit different from that to which the receiver is connected.
- Consult the dealer or an experienced radio/TV technician for help.

b. FCC Part 15.21 information for user

You are cautioned that changes or modifications not expressly approved by the party responsible for compliance could void your authority to operate the equipment.

c. FCC Part 15.19

This device complies with Part 15 of the FCC Rules. Operation is subject to the following two conditions:

7.2 FCC Warning Statement

(1) this device may not cause harmful interference and (2) this device must accept any interference received, including interference that may cause undesired operation.

FCC RF Radiation Exposure Statement

1. This Transmitter must not be co-located or operating in conjunction with any other antenna or transmitter.
2. This equipment complies with FCC RF radiation exposure limits set forth for an uncontrolled environment. This equipment should be installed and operated with a minimum distance of 20 centimeters between the radiator and your body.