

Sefram

RECORDER

DAS30- DAS50

USER'S MANUAL

Thank you for buying a SEFRAM recorder and for your trust in our company. The main goal of our various teams (research department, production, commercial, after-sales...) is to meet your requirements as much as possible by designing or updating high tech products.

With your recorder, you will find a CD-ROM including:

The user's manual of the DAS30 & DAS50 recorders

The "SeframViewer" software that makes it possible to print and treat your recording files under Windows®.

The Sefram Pilot pilot that makes it possible to program the appliance though an Ethernet link.

Please read cautiously this user's manual for an optimal use of your recorder.

Our teams are available to provide you any additional information:

04-77-59-01-01

Commercial service e-mail: sales@sefram.fr

After-sales service e-mail: sav@sefram.fr

Technical support e-mail: support@sefram.fr

Fax: +33 (0)4 77 57 23 23

Web: www.sefram.fr



Copyright Sefram, 2014. All rights reserved.

Any total or partial copy of this document needs the authorization of Sefram.

WARRANTY

Your instrument is guaranteed for one year for parts and workmanship against any default of manufacturing and/or functioning hazards. This guarantee starts from the delivery date and ends 365 calendar days later.

In case of guarantee contract, this will cancel and replace the warranty conditions above. This guarantee does not cover errors of use and/or manipulation.

To apply the warranty, the user shall return the appliance to our production unit:

SEFRAM Instruments & Systèmes After-Sales Service 32, rue Edouard MARTEL BP 55 42009 SAINT-ETIENNE CEDEX 2
--

Standard accessories provided with the appliance (cords, plugs...) and optional accessories (handbag, suitcase...) are covered 3 months against any manufacturing hazard.

The factory options integrated in the appliance are guaranteed for the same duration as the appliance itself.

What to do in case of malfunction?

In case of malfunction or for any problem of use, please contact the SEFRAM Instruments & Systèmes after-sales service.

A technician will take your call in charge and will provide you any required information to solve your problem.

What to do in case of machine failure?

In case of failure, please contact the SEFRAM Instruments & Systèmes after-sales service.

Need advice?

Need technical assistance?

SEFRAM Instruments & Systèmes commits itself to help you by phone for the use of your appliance.

Please phone: **04-77-59-01-01**

Or send an e-mail to: **support@sefram.fr**

1. TABLE OF CONTENT

2.	IMPORTANT INFORMATION.....	2.2
3.	PRESENTATION	3.1
3.2.1.	Connection:	3.2
3.3.1.	Description of the title bar.....	3.3
3.3.2.	Description of the channel validation window.....	3.4
3.3.3.	Description of the network analysis window	3.6
	MAIN MENU	3.7
4.	SET-UP and PRECAUTIONS of USE	4.1
4.1.1.	Precautions for storage of the recordings	4.1
4.3.1.	Tension measurement.....	4.3
4.3.2.	Temperature measurement with a thermocouple	4.3
4.3.3.	Temperature measurement with PT100/PT1000.....	4.3
4.3.4.	Current measurement	4.3
4.3.5.	Connection of the ground.....	4.4
5.	USE	5.1
5.3.1.	Analogic channels	5.4
5.3.2.	Additional functions between channels.....	5.6
5.3.3.	Logic channels.....	5.7
5.5.1.	Real time on-screen display of the measurements	5.9
5.5.2.	XY display.....	5.10
5.5.3.	Digital display	5.11
6.	TRIGGERS	6.1
6.1.1.	Single threshold.....	6.2
6.1.2.	Multiple thresholds.....	6.3
6.1.3.	Parasites.....	6.4
6.1.4.	Trigger on Logic Channels.....	6.5
7.	MATHEMATICAL CALCULATIONS	7.1
8.	DIRECT MODE.....	8.1
9.	MEMORY MODE	9.1
10.	TEMPLATE MODE	10.1
11.	FILE MODE.....	11.2
12.	NETWORK ANALYSIS	12.1
12.4.1.	Parameter acquisition file	12.6

12.4.2.	Recordable parameters	12.7
13.	FILE MANAGEMENT.....	13.2
13.2.1.	Save set-up files.....	13.3
13.2.2.	Load set-up files	13.3
13.2.3.	Save data acquisitions.....	13.3
13.2.4.	Recovery of the data acquisition files.....	13.5
13.3.1.	Transfer via FTP.....	13.7
13.3.2.	Display under SeframViewer	13.8
13.3.3.	Managing with SeframPilot.....	13.9
14.	INPUTS / OUTPUTS.....	14.2
14.2.1.	Use.....	14.3
14.3.1.	Use.....	14.4
15.	ETHERNET INTERFACE	15.2
15.1.1.	General.....	15.2
15.2.1.	Format of the reception messages	15.3
15.2.2.	Formats of emission messages	15.4
15.4.1.	Structure of the status data.....	15.7
15.4.2.	Service request logs	15.8
15.4.3.	Log of standard events.....	15.9
15.4.4.	Log of alarms.....	15.10
15.4.5.	Use of the status data structure	15.10
15.5.1.	Configuration.....	15.12
15.5.2.	Parameters of the channels	15.13
15.5.3.	Functions of the channels and between channels	15.15
15.5.4.	Paper	15.16
15.5.5.	Triggerings.....	15.17
15.5.6.	Triggers.....	15.18
15.5.7.	Memory mode.....	15.19
15.5.8.	Relaunchs, real time save	15.20
15.5.9.	Launching plots and data acquisitions.....	15.20
15.5.10.	Diagrams.....	15.21
15.5.11.	Direct display.....	15.22
15.5.12.	Mathematical functions	15.22
15.5.13.	Memory output	15.23
15.5.14.	Request of service.....	15.24
16.	TECHNICAL SPECIFICATIONS	16.1
16.1.1.	General characteristics.....	16.1
16.1.2.	Tension recording	16.1

16.1.3.	RMS recording	16.2
16.1.4.	Temperature recording	16.2
16.1.5.	Frequency recording:	16.2
16.1.6.	Enregistrement en Comptage :	16.2
16.1.7.	Sampling	16.3
16.1.8.	Bandwidth.....	16.3
16.2.1.	Logic channels	16.4
16.2.2.	Alarm outputs	16.4
16.2.3.	External power supply	16.4
16.7.1.	Ranges and accuracies for tension and intensity	16.6
16.7.2.	Frequency	16.6
16.7.3.	Power factor.....	16.6
16.7.4.	Peak and peak factor	16.6
16.7.5.	Rate of harmonics as calculated in power analysis	16.7
16.9.1.	Ethernet.....	16.7
16.9.2.	USB connectors	16.7
16.11.1.	Weather conditions	16.8
16.12.1.	Dimensions and weight	16.8
16.13.1.	Electromagnetic compatibility according to EN 61326-1 and 61326-1-2.....	16.9
16.13.2.	Security, insulation class, installation category.....	16.10
16.14.1.	Accessories provided with the appliance.....	16.11
16.14.2.	Accessoires et options	16.11
16.14.3.	Consumables.....	16.11
17.	APPENDS	17.2
17.1.1.	Insulated tension type inputs	17.2

2. IMPORTANT INFORMATION

Please read cautiously the following instructions before using your recorder.

2.1. Specific cautions

Do not use the product for any other use than planned.

Use **normalized cords** for the connection of the appliance to the measurement points.

To prevent any risk of electric shock, never plug or unplug the measurement cords when linked to the mains.

Never use in a wet environment.

Never use in an explosive atmosphere.

In case of malfunction or for the maintenance of the appliance, only a qualified personal shall be allowed to work on it. In such a case, it is necessary to use Sefram spare parts.

Never cover the appliance: there is live tension.

2.2. Security instructions

For correct use of the appliance, it is necessary that the users abide by the security instructions and the instructions of use described in this manual.

Specific warnings are provided all along this manual.

If required, there are warning symbols on the appliance



Symbols and definitions

Symbols in this handbook:



Warning: potential danger for the user



Attention: potential danger for the appliance and/or the connected equipment



Remark: important information.

Symbols on the appliance:



Danger (high tension): immediate corporal danger



Attention: See the handbook. Risk of damage to the material connected to the instrument or to the instrument itself



Ground: accessible parts linked to the ground of the appliance.

2.3. Conformity and limits of the appliance

The DAS30 & DAS50 recorders are in conformity with CEI 61010-1 (2001-02).

It includes high-potting (IR) with two primary insulation levels (IP).

Thanks to them, the channels 1 to 4 are insulated from each other and from the carter. This architecture allows independent floating measurements within the limits of the admissible maximum tensions.

See chapter "Technical specifications".

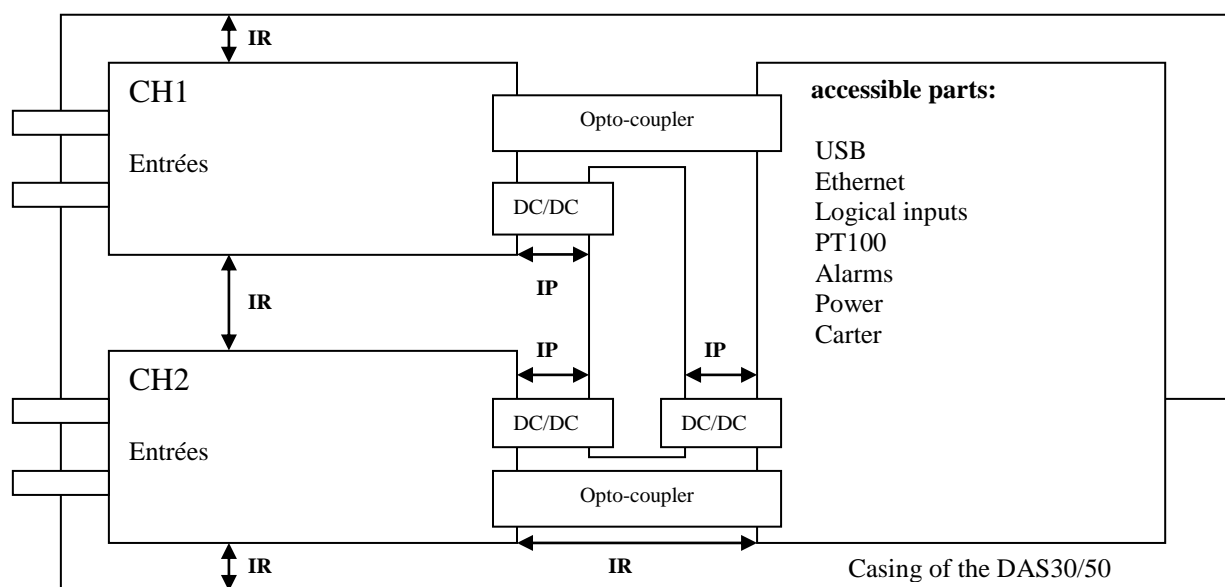

IP: Main or additional insulation

IR: Reinforced insulation



Attention: Never apply a tension higher than the maximum admissible tension between the channels and from the ground of the carter.

3. PRESENTATION

3.1. General

DAS30 & DAS50 are programmable recorders that make it possible to measure and record tensions, intensities, temperatures, etc. on 2 to 4 channels and on 16 logical channels. As an option, you can also record from PT100 or PT1000 probes.

An integrated thermal printer option makes it possible to print signals in real time.

They can work in several modes:

- Direct, for paper printing (option)
- Memory, for acquisition on internal quick memory
- File, for acquisition on internal SD card
- Template, for acquisition on a pre-recorded template
- Analysis of network

The "operator – recorder" dialog is made easier thanks to an intuitive interface on a wide touch screen. The measurement parameters are easy to program.



3.2. Description

3.2.1. Connection:

- 1- A RJ45 connector for the ETHERNET 10/100BaseT interface
- 2- two USB connectors for (female) USB stick
- 3- a SUB-D 25-pin connector for the 16 logic inputs and the alarm outputs
- 4- 2 to 4 inputs through pin plugs according to the appliance
- 5- 2-way option PT100 (screw terminal block)
- 6- Power/Battery charger (on the upper side)
- 7- Power on button and light
- 8- Battery charging LED

Isolated inputs have 2 security terminals on each input:

- 1 red terminal: input « + »
- 1 black terminal: input « - »

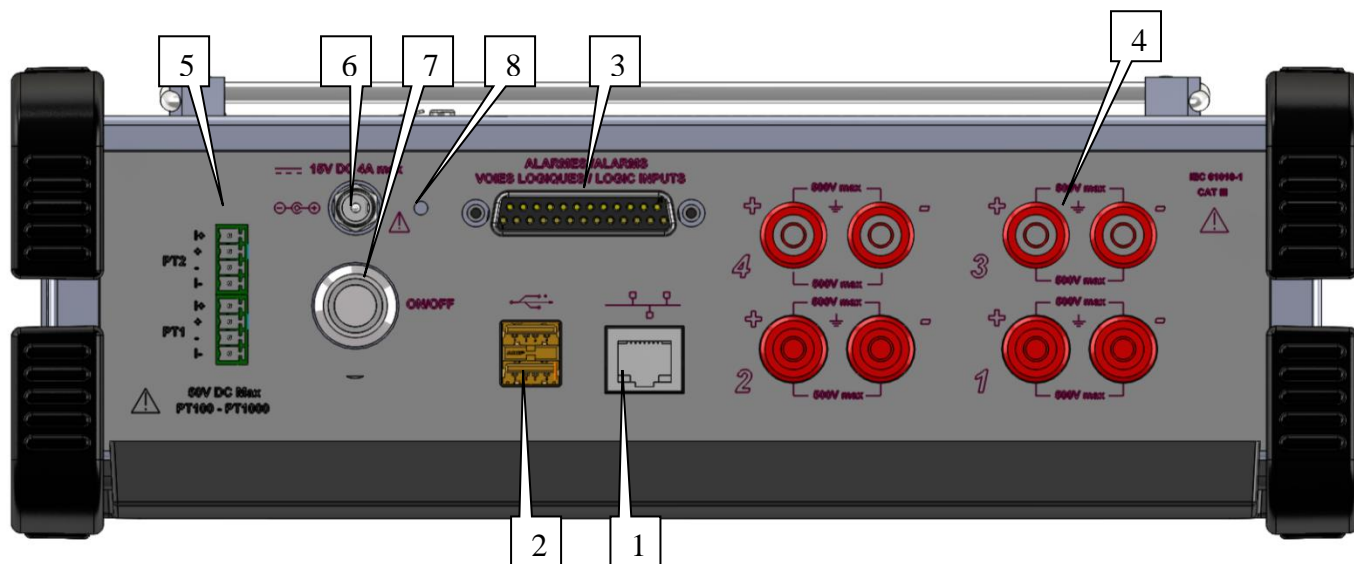

3.3. Touch screen

3.3.1. Description of the title bar

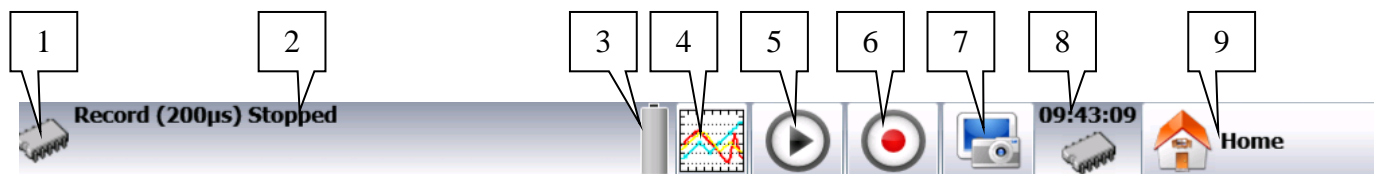

Various zones on the screen:

- 1- Current mode (direct mode, memory mode...)
- 2- Status of acquisition (pending acquisition, stop)
- 3- Status of the battery
- 4- Direct access to display
- 5- Access to the display of the memory
- 6- Access to the recording
- 7- Screenshot button
- 8- Date and time
- 9- Access to the main menu

Note: By pressing on the date and time, you can access to the menu to change this information.

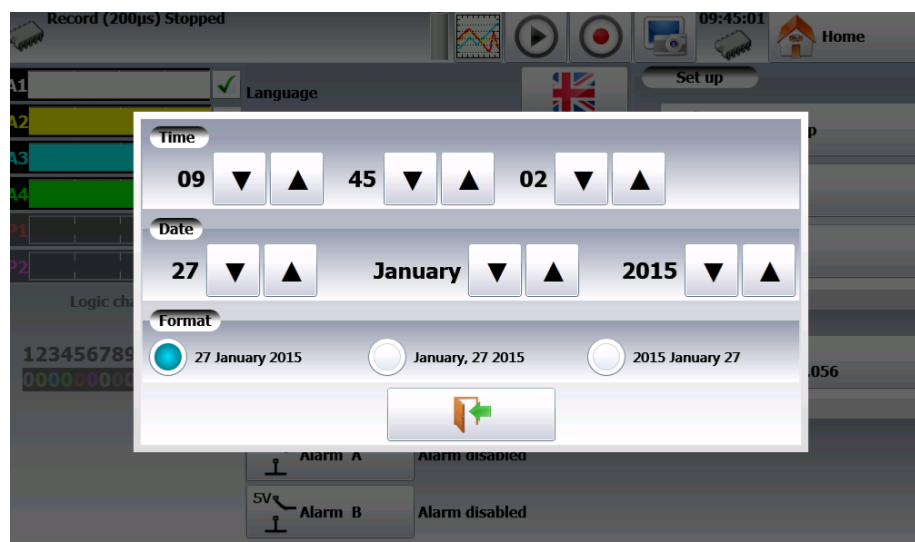

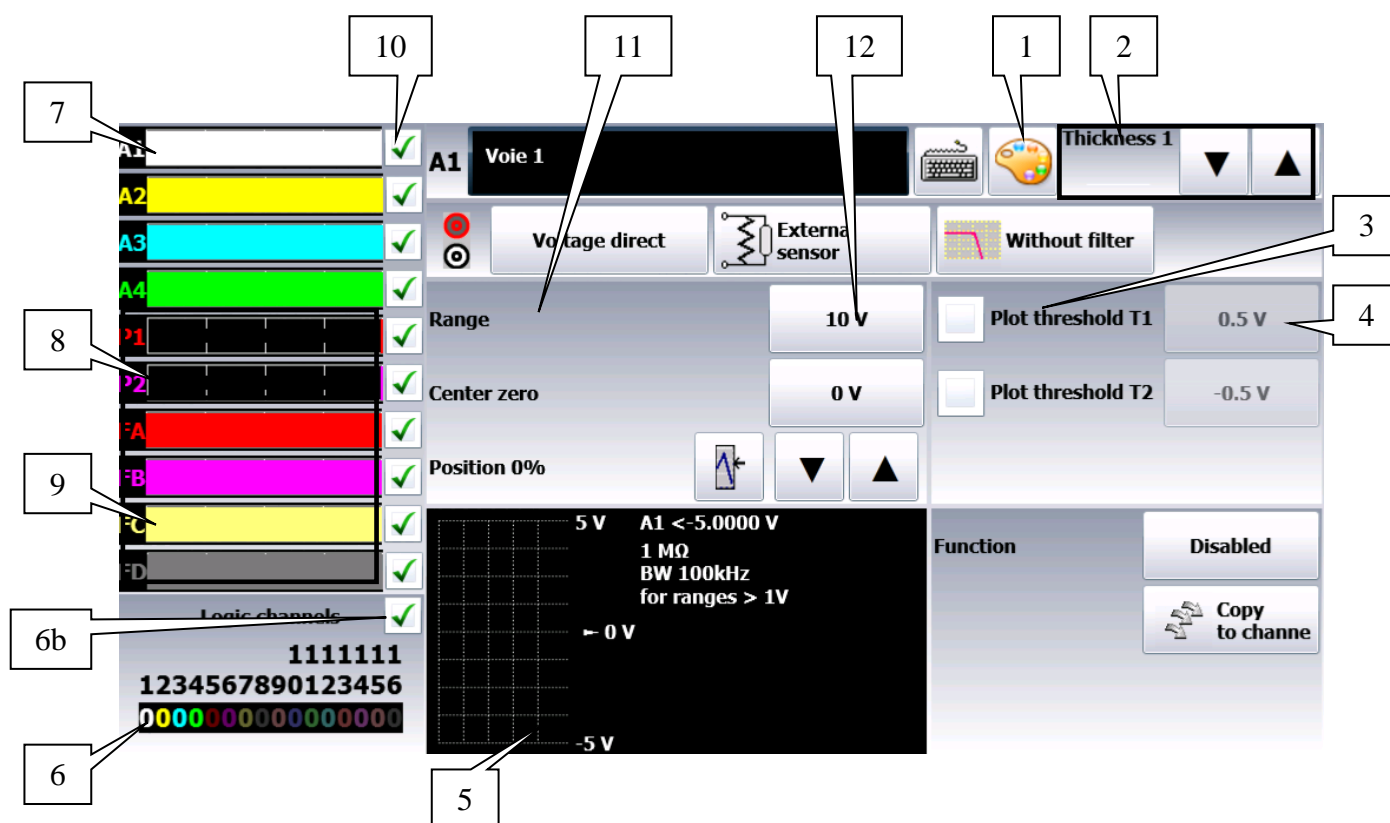

3.3.2. Description of the channel validation window



1- Change of the color of the channel (by pressing this button, you can access pre-defined colors or design customary paint mixes:



2- Change the thickness of the line for the selected channel. You can also change this

thickness with the  (thinner) and  (thicker) keys

3- Checkbox to validate a threshold

4- Current threshold value or change of the threshold value

5- Information about the channel (caliber, thresholds, offset...)

6- Logic inputs : real time status of the logic inputs

6b- Logic inputs : validation of the logic inputs

7- Access to the parameters of the various channels

8- Temperature channels through PT100 or PT1000 type sensors

9- Function channels (they allow calculations between two channels)

10- Checkbox for validation of the channels

11- Parameter zone: you can change the name of the parameters

12- Key to change of parameter and display the current value

Note: By pressing the logic inputs, you pop up a window with all logic channels.

Some information is available on this window:

- when clicking on a logic channel, the relevant pin on the connector turns red
- when pressing the keyboard, you can change the name of the channel.



3.3.3. Description of the network analysis window

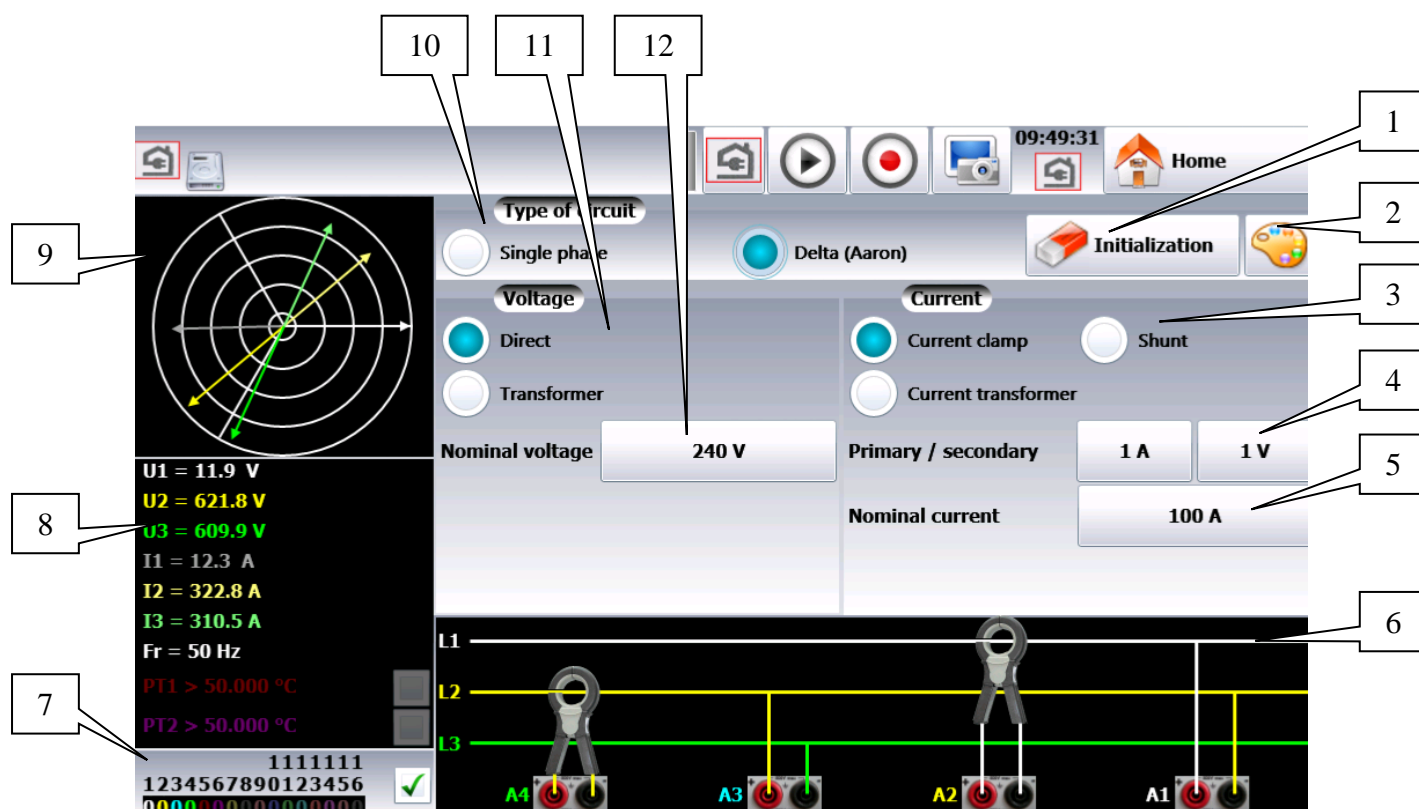

- 1- Setup of the network analysis
- 2- Changing the color of the various measurements (tension, current, power...)

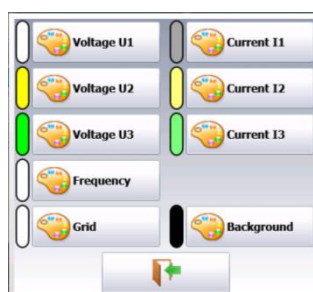





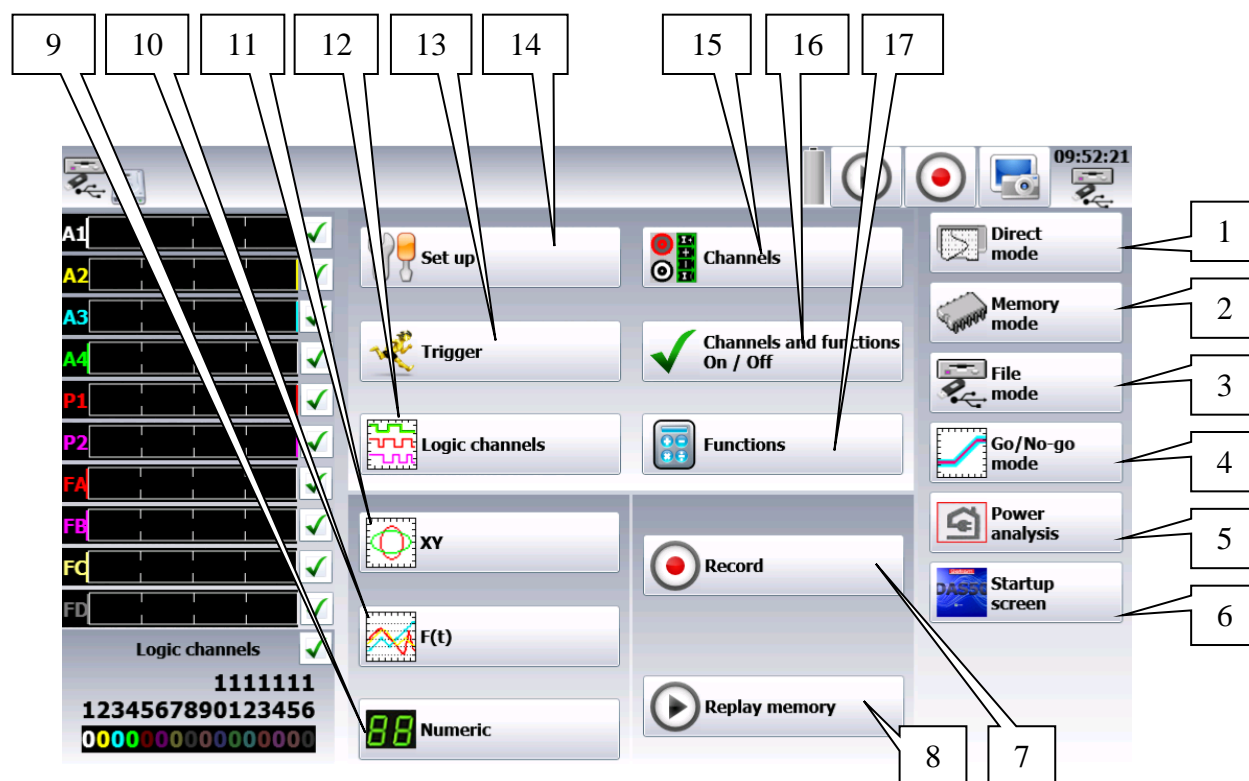

- 3- Measurement mode of the current (clamp, shunt, transformer)
- 4- Parameters of the current measurement (conversion from the measured value and the value sent to the recorder)
- 5- Nominal current in the phase conductor
- 6- Wiring scheme
- 7- Logic channels (validation and parameter setting)
- 8- Display of the measured values
- 9- Phase diagram
- 10- Type of network
- 11- Parameters of tension
- 12- Value of the nominal tension

MAIN MENU



- 1- Direct mode key (direct printing of the curve)
- 2- Memory mode key
- 3- File mode key
- 4- Template mode key
- 5- Network mode key
- 6- Start screen to display the serial number, the software version...
- 7- Recording
- 8- Replay of the memory
- 9- Digital display of the values of the various inputs
- 10- Display of the F(t) curve
- 11- Display of the XY curve
- 12- Configuration of the logic channels
- 13- Adjustment of the triggers
- 14- Set-up of the appliance (language, date and time, alarm outputs, update of the internal software, network connection, recovery of the configuration...)
- 15- Access to the table of channel configuration:

	A1 	A2 	A3 	A4 	PT1 	PT2 
 Name	Channel 1	Channel 2	Channel 3	Channel 4	PT1	PT2
Type	Voltage direct	Voltage direct	Voltage direct	Voltage direct	PT100 2 wires 0.00 Ω	PT100 2 wires 0.00 Ω
Filter	Without filter	Without filter	Without filter	Without filter	10 Hz	10 Hz
Function	Disabled	Disabled	Disabled	Disabled	Disabled	Disabled
Range	10 V	10 V	10 V	10 V	100°C	100°C
Center zero	0 V	0 V	0 V	0 V	0°C	0°C
Max.	5 V	5 V	5 V	5 V	50°C	50°C
Min.	-5 V	-5 V	-5 V	-5 V	-50°C	-50°C
Threshold T1	0.5 V	0.5 V	0.5 V	0.5 V	0.5°C	0.5°C
Threshold T2	-0.5 V	-0.5 V	-0.5 V	-0.5 V	-0.5°C	-0.5°C

Note: By pressing various parameters, you can change them. In addition, by pressing the name of the channel (A1, A2...), you directly access the parameter setting page of the channel

- 16- Configuration of the function channels (calculations between several channels)
- 17- Activation or deactivation menu of the various channels.

3.4. Update of the internal software

The internal software is regularly updated with the latest evolutions. These updates are available on our website.

http://www.sefram.com/wwwfr/F_D_SOFTWARE.asp

To update it, copy the file you receive on an USB stick.
Plug it on to the USB connector at the rear of the appliance.

Press , then press  to access to the update.

To launch the update process, press .

The internal software automatically copies the files required for the new version.

Stop and restart the appliance at the end of the update process.

4. SET-UP and PRECAUTIONS of USE

4.1. Loading of the recording paper

NOTE: Only one face of the paper is heat-sensitive. Reversing the paper at loading will result in the absence of any printing out.

Procedure:

- Lay the appliance on the right side
- Lift the extractor of the roller on the lid
- Install the paper into the receptacle ("no de ref" must be on the side of the plugs)
- Introduce the paper into the slot of the lid
- Close the lid by firmly pressing it on both sides.



A bad paper feed could damage the motor and the thermal head. You should take great care when putting it in place.

The recorder shall always receive paper, because the thermal head may be damaged in case of extended direct contact with the roller.

4.1.1. Precautions for storage of the recordings

In order to maintain the quality of the paper recordings, it is advisable to abide by precautions of handling:

- never use laminated sleeves
- store away from light, in a dry and cool place.

Cardboard sleeves are advisable.

4.2. Set-up

You turn on the recorder by pressing the button at the top of the appliance.

When the appliance is on, the ON/OFF button is lit blue.

After launching the software, the recorder displays a homepage that specifies the hardware version, then switches automatically to the « **Direct display** » mode (oscilloscope).

You can display this homepage any time in the main menu by pressing  F(t).

To turn off the appliance, you only have to press the ON/OFF button twice.

If the appliance does not stop correctly, you must press the ON/OFF button 5 seconds; in this case, the configuration won't be saved.

4.3. Configuration at power-up

At power-up, the appliances start with the latest configuration when they were shut down.



If the configuration has changed at power-up, contact the after-sales service.

If the initial set-up is wrong, you can reload the default configuration.

Go to the main menu. Press  Set up, then  Default set up

CONNECTION TO THE MEASUREMENT NETWORK

4.3.1. Tension measurement

The tension is measured between the red and black terminals of the inputs with wires and male security pin plugs (according to CEI 1010).

4.3.2. Temperature measurement with a thermocouple

The tension resulting from thermocouple effect must be measured between the red and black terminals of the relevant input. To provide right measure values, connect the two ends of the thermocouple cord directly onto the quick fastening socket. Plug the two pin plugs onto the selected input with respect of the polarity.



Do not use welding male pin plugs: the welding would alter the thermocouple effect.

4.3.3. Temperature measurement with PT100/PT1000

The PT100 probe must be connected on the « I+ » et « I- » terminals.

The tension from the PT100 must be measured between the « + » and « - » terminals with one of the two following mountings: 2, 3 or 4 wires. The 3 or 4-wire mountings make the measurement independent from the resistance of the line.

Wiring:



2 wires



3 wires



4 wires

4.3.4. Current measurement

You can make current measurements by **shunt** between the red and black terminals of the relevant input.

In this case, select the "**current**" type among the parameters of the relevant channel. Connect the measurement wires to the terminals of the shunt.

The results are directly displayed in Amperes or milliamperes according to the caliber of the selected channel.

4.3.5. Connection of the ground

- If the source of the signal you have to record has **low internal impedance**, you shall use **twisted wires**. In case of **high impedance**, you shall use **shielded wires**.
- When gathering grounds from the various items on the measurement line, it is good to check that there is no voltage difference between them, in order to prevent any shortcut. If any doubt, make a measurement with a voltmeter on a low resistance (i.e. 1k Ω) between the terminals.

4.4. Routine maintenance

Maintenance only consists in cleaning outside the appliance. Any other operation requires a qualified personal.



Unplug the appliance before any intervention.

Never let water flow through the appliance to prevent any electrical discharge.

Periodically clean the recorder with the following the instructions:

- use water and soap to clean the front and rear boards
- never use any product that contains petrol, benzine or alcohol: they would damage the screen printings
- wipe with a soft lint-free cloth
- use some antistatic product to cleanse the screen.

4.5. Battery

The appliance is equipped with a lithium-ion battery (Li-ion). It is sent with charged battery. However, if the appliance has remained unused for more than one month, check its loading status and reload it if required.



Attention: Any intervention on the battery requires dismantling of the appliance and shall be made by a SEFRAM technician.
Only use batteries provided by SEFRAM.

Security advice:

- Never heat up or throw the battery pack into the fire
- Never shunt parts of the battery: risk of explosion!
- Do not bore the battery
- Do not dismantle the battery pack
- Do not reverse the polarities of the battery
- This battery pack includes a protective item that shall not be damaged or removed
- Do not store the pack in a place exposed to heat
- Do not damage the protective sheath of the pack
- Do not store the appliance in a vehicle exposed to sunbeams.

The battery should last 200 charge-discharge cycles or 2 years.

Advice to extend the life of the battery:

- Do not discharge too much
- Do not store the batteries too long without using them
- Store the battery at around 40% charge
- Do not fully charge or discharge the battery before storage.

When the battery is practically discharged, the appliance closes all open files, stops correctly the software, then shuts up by itself.



Attention: When the charger is connected to the appliance, the metal frame is grounded.

To recharge the battery inside the appliance:

Connect the provided external power supply on the jack plug of the appliance.

Connect the mains.

The internal charger starts loading the battery; the green light of battery charge lights up.

You can charge the appliance **when on or off**.





When the battery is loaded, the light turns off automatically.

External power supply

The appliance can be powered by an external direct voltage power supply. It works under 15V (5A). The charger block provided when you bought the appliance can also work as an external power supply.

4.6. Offset calibration

You can easily calibrate the recorder inputs for the tension and thermocouple offsets. To do so:

- Let the appliance work for 20 minutes (ambient temperature 20-25°C)
- Link the « + » to « - » terminals on each input (resp. the red and black terminals for the isolated inputs)
- Validate all 'ON' channels
- Go to the homepage of the recorder and press  .
- Select  then  .
- Press  to validate the calibration; it will last ca. 5 minutes.

4.7. Default calibration

You can restore the default factory calibration to correct any possible mistake in the calibration coefficients:

Go to page « **Electric calibration** » (see the previous section)

Press  and validate to restore the default factory calibration coefficients.

5. USE

5.1. Description of the various modes

Selection of the functioning mode of the recorder:

→ **DIRECT** mode:

- real time print out of the measured signals (Option)
- use: immediate paper printing, slow protracted data acquisition
- possibilities: complex triggers of the drawing, action after the end of the drawing, simultaneous record on file

→ **MEMORY** mode:

- quick acquisition into internal memory of the measured signals
- use: quick short data acquisition (transitory)
- possibilities: complex triggers of the data acquisition, action after the end of the data acquisition, simultaneous record on file

→ **TEMPLATE** mode:

- quick acquisition into internal memory of the measured signals
- use: quick short data acquisition (transitory) for capture of non repetitive events
- possibilities: complex triggers, particularly when outrunning a pre-recorded template from a channel, action after the end of the data acquisition, simultaneous record on file

→ **FILE** mode:

- quick acquisition into internal memory of the measured signals
- use: quick protracted data acquisition (only restricted by the size of the saving means)
- possibilities: complex triggers, action after the end of the data acquisition, acquisition of very big amounts of data.



→ **NETWORK ANALYSIS** mode:

- single-phase network analysis
- three-phase analysis, Aaron mode (two-wattmeter method) (only on DAS50).
- Data acquisition on internal memory.

5.2. Set-up menu

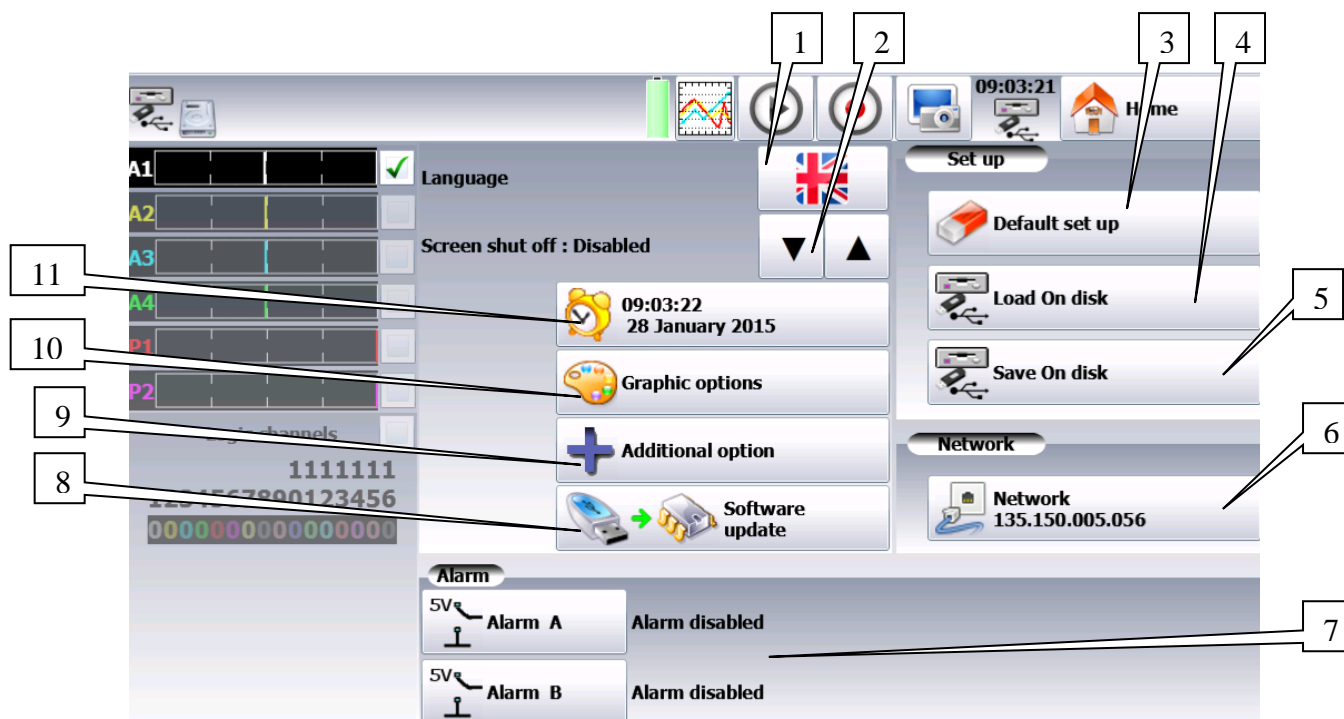
General configuration of the appliance, monitoring of the alarm outputs, network address TCP/IP, calibration of the channels, update of the internal software.



- 1- Language: selection of the language of the appliance
- 2- Screen intensity: increase/diminution of the backlighting of the LCD screen, adjustment of the delay with the keys  (decrease) and  (increase)
- 3- Default set-up: initialization of the appliance in default configuration
- 4- Load on disk: loading a configuration recorded on the internal storage means or on an USB stick
- 5- Save on disk: saving the configuration on the internal storage or on an USB stick
ATTENTION: the current configuration shall be lost
- 6- Network: Change of the IP parameters and of the network options
- 7- Alarm A or B: use of the alarm outputs A or B (0-5V outputs)
 - None: no condition monitors the contact; it remains always open
 - Trigger: control by a combination of analogic or logic channels on several thresholds (see chapter Triggers)
 - Paper error: control by paper shortage or opening of the door of the printing block (Option).
- 8- Software update: update of the internal software (see chapter Presentation)
- 9- Additional option: change of various parameters:
 - Bip keyboard: activation or deactivation of the Bip keyboard
 - Electric calibration: calibration of the channel offsets, reset to factory offsets
- 10- Graphic options: max position of the bargraph: scrolling direction of the bargraph of each channel on screen:
 - Right: max. value of the right channel
 - Left: max. value of the left channel

11- Date change: changing the date and time of the appliance

5.3. Channels Menu

By pressing the menu « channels », you access the table of all available analogic and temperature channels of your recorder.



	A1	A2	A3	A4	PT1	PT2
Name	Channel 1	Channel 2	Channel 3	Channel 4	PT1	PT2
Type	Voltage direct	Voltage direct	Voltage direct	Voltage direct	PT100 2 wires 0.00 Ω	PT100 2 wires 0.00 Ω
Filter	Without filter	Without filter	Without filter	Without filter	10 Hz	10 Hz
Function	Disabled	Disabled	Disabled	Disabled	Disabled	Disabled
Range	10 V	10 V	10 V	10 V	100°C	100°C
Center zero	0 V	0 V	0 V	0 V	0°C	0°C
Max.	5 V	5 V	5 V	5 V	50°C	50°C
Min.	-5 V	-5 V	-5 V	-5 V	-50°C	-50°C
Threshold T1	0.5 V	0.5 V	0.5 V	0.5 V	0.5°C	0.5°C
Threshold T2	-0.5 V	-0.5 V	-0.5 V	-0.5 V	-0.5°C	-0.5°C

Logic channels



1111111
1234567890123456
0000000000000000

This table gives you a quick insight of the various adjustments of the channels. You can change these adjustments directly in this table by pressing the parameter you want to update.

You can access the setting of parameters channel by channel by pressing the name of the channel at the top of the table (A1, A2...) or by pressing on the bargraph of the channel (right side of the screen).

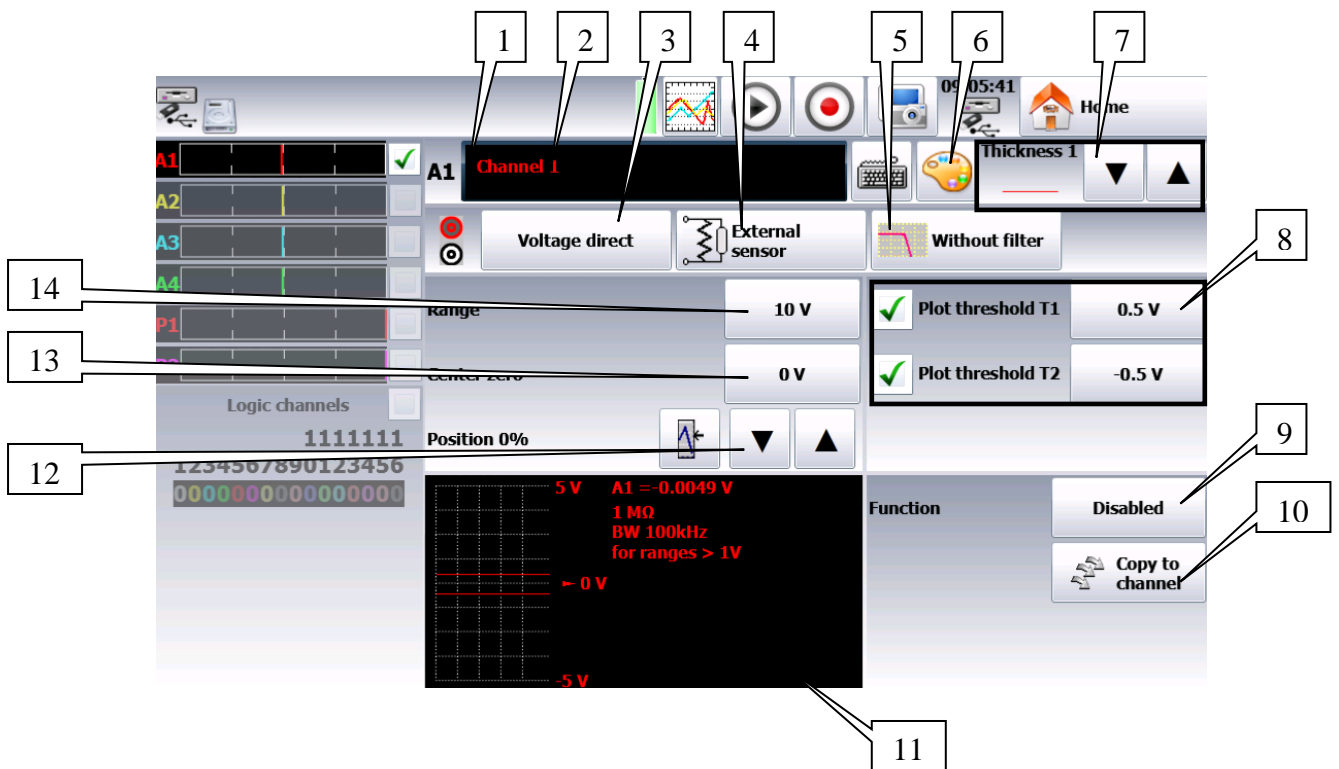
5.3.1. Analogic channels



- 1- Number of the channel
- 2- Name of the channel: give a name to the channel (max. 26 characters)
- 3- Type: selection of the type of measurement made on the input
 - tension, current, frequency, thermocouple or counter
 - direct or RMS
 - value of the shunt for current measure (sensor 4-20mA automatic)
 - selection of the type in thermocouple, compensation, unit
- 4- Type of external sensor
- 5- Filter: positioning of a filter on the input
 - 10kHz, 1kHz, 100Hz, 10Hz for analogic filters
 - 1Hz, 10s, 100s or 1000s for the digital filters (according to the type of signal)
- 6- Change of the color of the channel
- 7- Change of the thickness of the signal with the keys  (decrease) and  (increase)
- 8- Validation and adjustment of the trigger thresholds 1 and 2

Note: A warning message pops up when the programmed analogical thresholds are out of the measurement range.

9- Function: makes it possible to append a mathematical calculation function to the relevant channel

- None: no function
 - Change of unit: changes the unit of the measures made on the channel; you can program a couple of dots X1, Y1 and X2, Y2 for scaling
 - Calculation: available mathematical functions, associated parameters and unit
- $aX+b$: identical to the change of units, but instead of giving a couple of dots, you give the intercept (b) and the slope (a).
 - $a|X|+b$: absolute value
 - aX^2+b : square
 - $a\ln(X)+b$: Napierian logarithm
 - $a\text{Sqrt}(X+c)+b$: square root
 - $a\text{Exp}(cx) +b$: natural exponential
 - $a(1/X) +b$: reverse.

10- Copy to channel: makes it possible to copy the adjustment of a given channel onto one or several other channels

11- Display window for the thresholds, caliber, zero offset...

12- Adjustment of the position: position of the zero on screen or on the paper from -100 to 100%:

i.e. in RMS mode, it is interesting to have zero at the minimum value (-100%); you will get the max. value = caliber

13- Adjustment of zero: Zero (or center or offset) is the central value of the measurement.

Note: When using a mathematical function or a scale change, zero is the zero of the requested unit.

14- Adjustment of the caliber: the caliber is the measurement range corresponding to the full width of the screen, where the channel is plotted.

5.3.2. Additional functions between channels

There are function channels on this appliance. You can activate up to 4 function channels (FA, FB, FC, FD).

These channels make it possible to make calculations between channels or calculations of average values...

For example, if you want to calculate a value of power, select the parameters of the A function channel

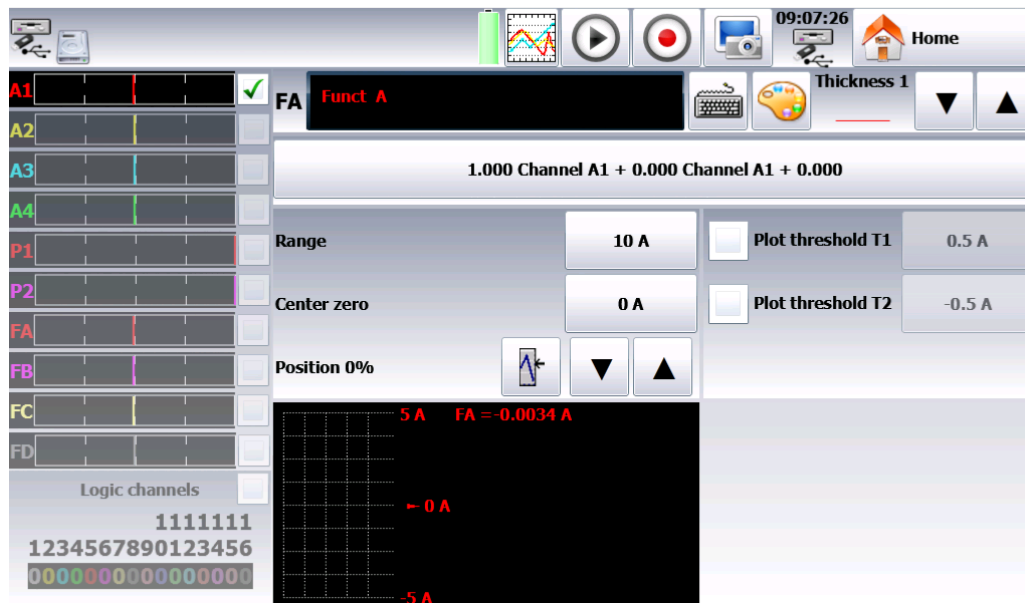

You get this page above. Then, you make the calculation you want by pressing the formula bar and create the calculation you want in the following window:

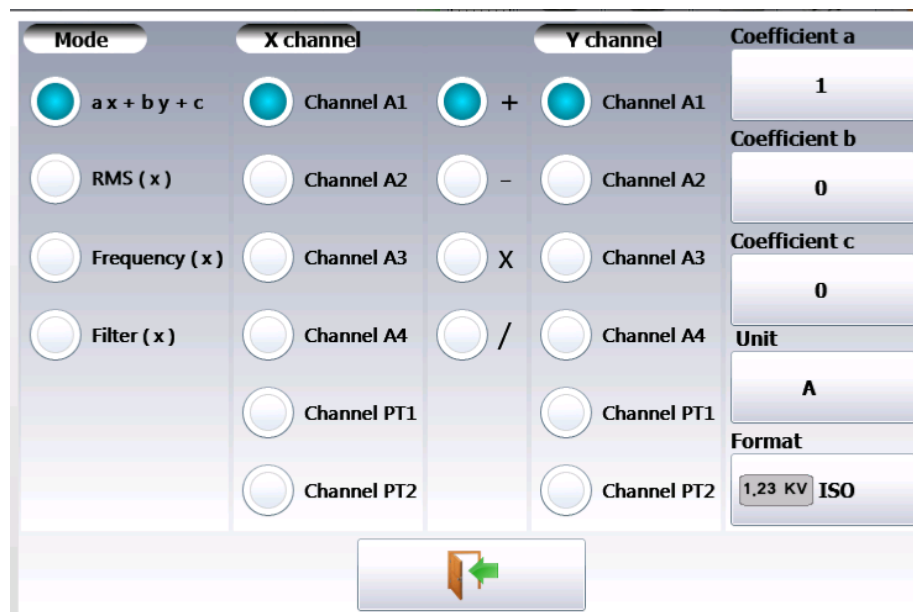

For the calculation of power, you will have: $a(x*y) + b$ with:
 $x = \text{channel A1}$
 $y = \text{channel A2}$

operator = *
 coefficient a = 1

unit W
 coefficient b = 0

5.3.3. Logic channels

The 16 logic channels can be recorded simultaneously with the analogic channels. To set the parameters of the logic channels, you can press the « logic channels » menu on the main window or directly press the logic channels part at the bottom of each configuration window:

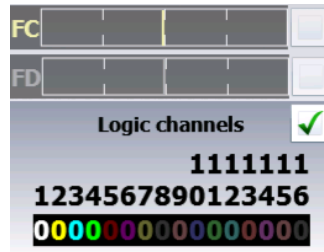

You access the configuration page of the logic channels:

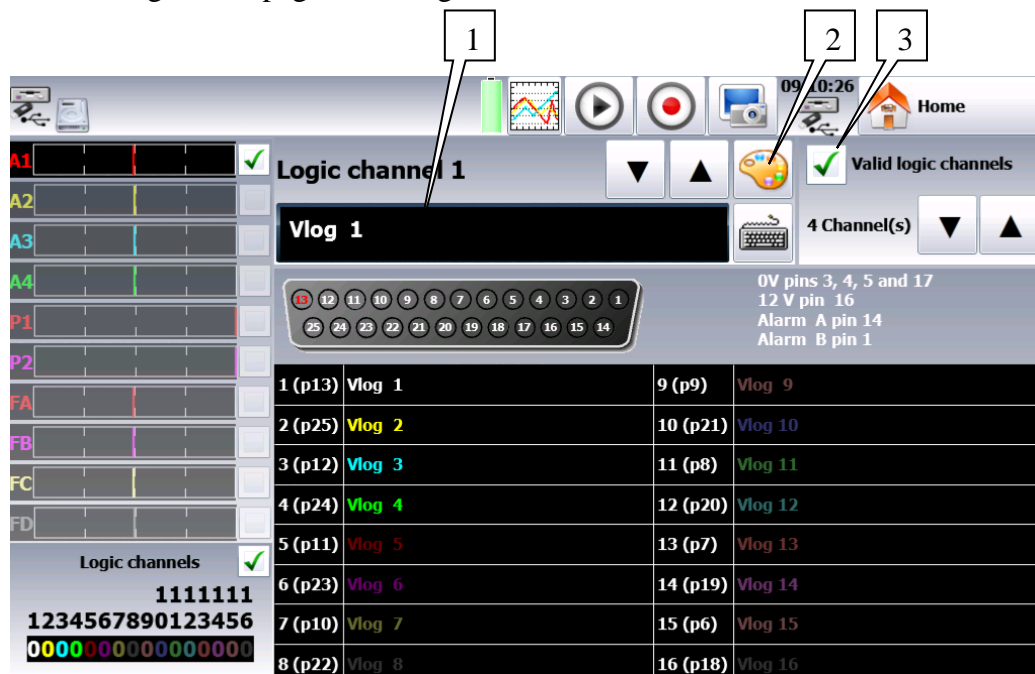

- 1- Selection of the name of each channel on screen
- 2- Selection of the color of each channel on screen
- 3- Logic validity: validation of the data acquisition and plotting of the logic channels

5.4. Validation of the channels

You can validate or not the channels to record or print out in the various configuration menus of the recorder.

In order to validate or not the record or the printing of a channel, you must check (to validate) or uncheck (not to validate) the checkbox right to the bargraph of the channel.



5.5. « Direct display » key

5.5.1. Real time on-screen display of the measurements

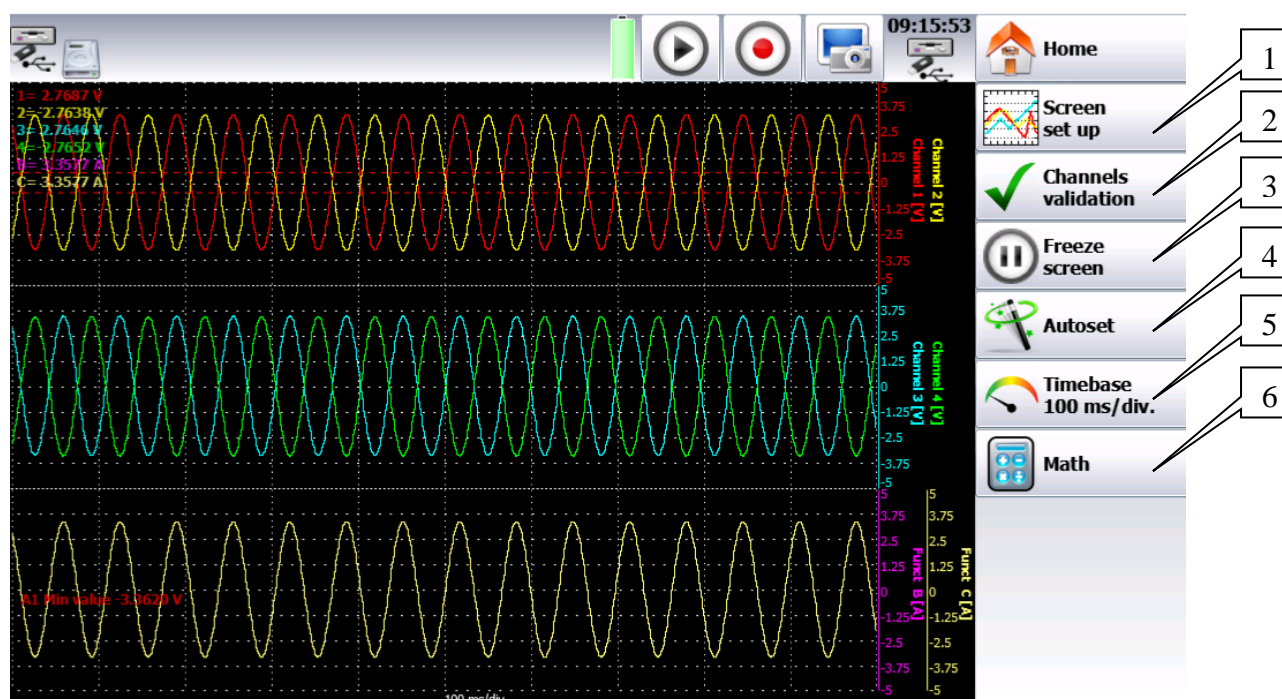

- 1- Screen configuration: configuration of the display of measurements on screen.
Selection of the mode of graphic display:
 - F(t)
 - XY
 - Digital measures (full screen)
 - Full screen to display the reticule on the whole screen (mode f(t))
 - Colors to customize the display (background, reticule, cursor)
 - Graphic option
- 2- Channels validation: Validation of the channels to display
If the logic channels are actives, you shall select whether the diagram of the logic channels should be distinct from the analogic channels or not (see chapter 4.3.3).
- 3- Freeze screen: freeze the measurements on screen to make measurements by cursors, make calculations, save or print the measures on screen (1000 dots) in F(t) mode.
You get access to:
 - **Relaunch** – relaunches the sweep
 - **Time Cursors** displays the vertical cursors (2) to make measurements on the screen; move the cursor by selecting it with your fingers or the mouse.
 - **Tensions Cursors** displays the horizontal cursors (2) to make amplitude measurements on the screen; proceed like for the time cursors to move them. You can also change the caliber / zero to expand and move your measurement on screen.
- 4- Autoset: This function allows you to have automatically the caliber of the active channels and the timebase compatible with the frequency of the signal.
- 5- Timebase: Allows you to settle the timebase.
- 6- Math: Makes it possible to display values of mathematical calculations on screen.

5.5.2. XY display

The **XY** display mode makes it possible to display the validated channels in real time one against the other.

One of the channels defines the horizontal axis; the other channels provide dots on the vertical axis.

You can access the XY mode via the main menu by pressing

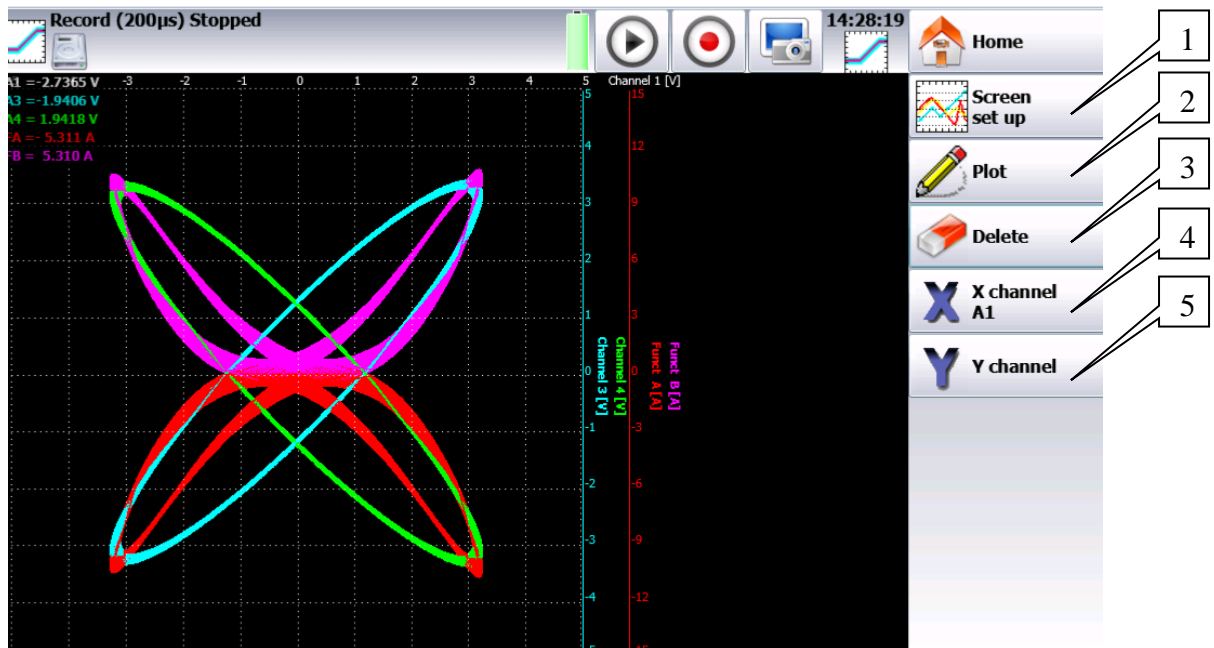

- 1- Screen set-up: configuration of the display of measurements on screen.
Selection of the mode of graphic display:
 - F(t)
 - XY
 - Digital measures (full screen)
 - Full screen to display the reticule on the whole screen (mode f(t))
 - Colors to customize the display (background, reticule, cursor)
 - Graphic option
- 2- Plot: starts or stops of the plot
- 3- Delete: erases the screen
- 4- X channel: selection of the channel on the horizontal axis (sweep)
- 5- Y channel: the Y channels are the valid channels

5.5.3. Digital display

The **Digital display** mode displays the digital values of all channels in real time on screen. When pressing one of the channels, you access directly to the parameter page of the corresponding channel.

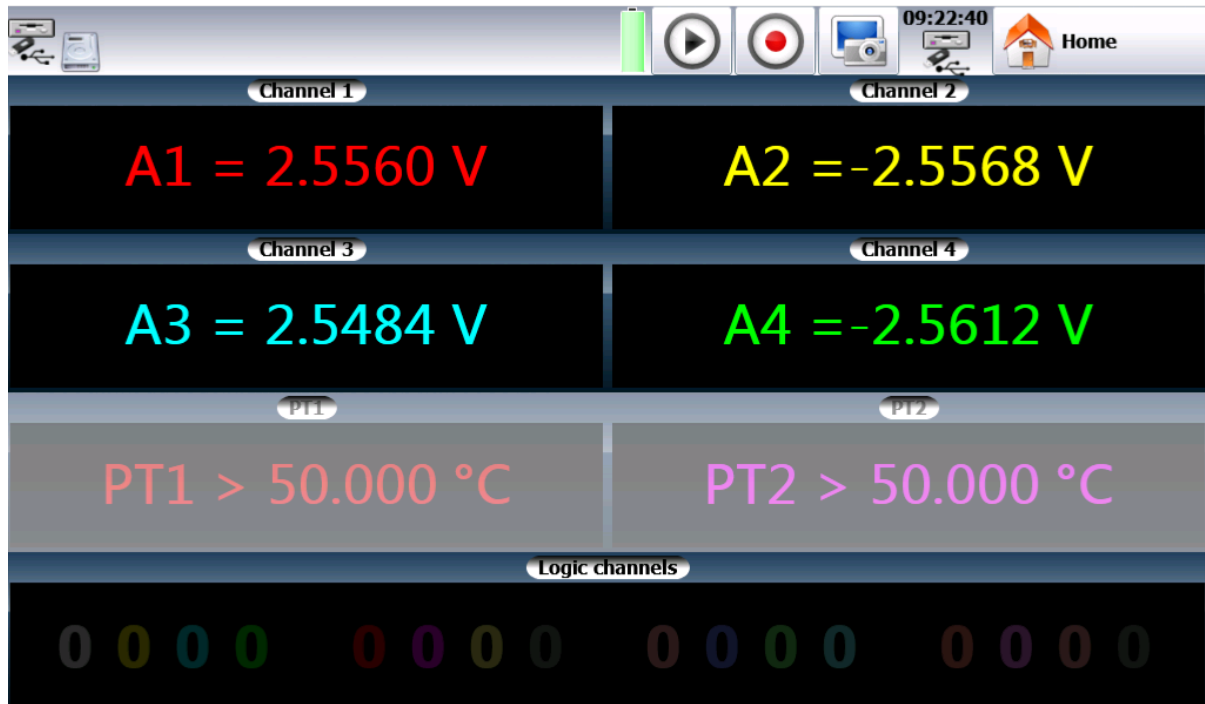

5.6. « Trigger » menu

Programming the start and stop conditions for the paper print in Direct mode, and the data acquisition conditions for the channels in Memory, File and Template modes.

Selection of the actions after data acquisition or plot and validation of the save in real time.



The program of triggers is different according to the pending mode (Direct, Memory, File or Template).

See the chapter of the pending mode for more details.

5.7. « Memory output » key

Display on screen of the data acquisitions available from the internal memory or from files of the internal memory or an USB stick.

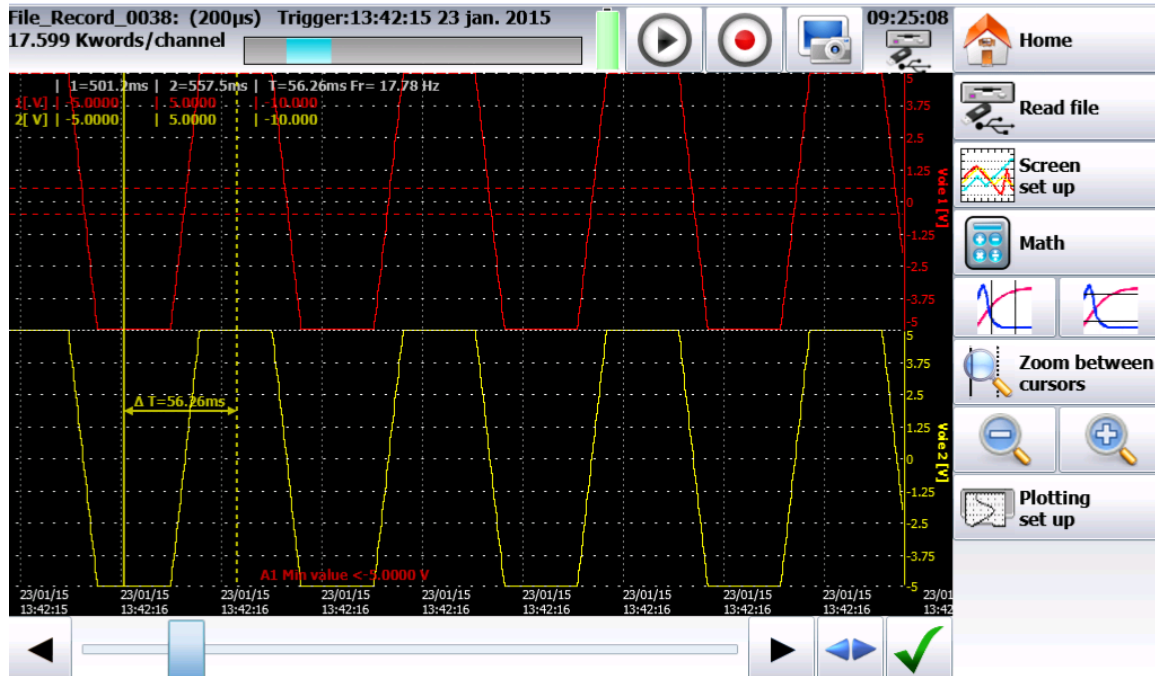

This function includes the same commands as the « **Direct display** » function.

The « **Read block or file** » command allows you to select the memory block (zone inside the internal memory) or the file to display.

When pressing this key, the following window pops up:

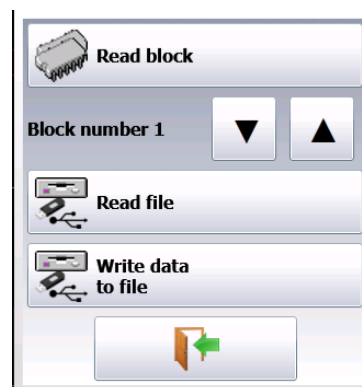

- Block number: number of the memory block to display
- Read file: selection of the file to display
- Write data to file: save the current display into a file



When the size of the data acquisition to display is big, it may take time to recover and display the dots.

The display is made in 2 phases:



- A quick phase to display the frame of the data acquisition: some dots may not appear
- A slower phase where all data acquisition dots are displayed: the advancement percentage is displayed at the bottom of the screen.

5.8. « Record » key

This key has various effects according to the current mode of the appliance.

- 1- **Direct** mode: launches the paper printing if the trigger is in manual **Start**; else, the appliance waits for the start condition.
- 2- **Memory** mode: launches the data acquisition into internal memory; the appliance waits for the start condition
- 3- **Template** mode: launches the data acquisition into internal memory; the appliance waits for the start condition
- 4- **File** mode: launches the data acquisition into file; the appliance waits for the start condition
- 5- **Network analysis** mode: real time data acquisition directly into the internal memory (there is no trigger)

In all cases, to force the record to start or stop when the conditions registered in the recorder are not

met, you only have to press  (to force the record) and  (to force it to stop).



In **Memory**, **Template** or **File** mode, the appliance switches automatically to display of the current data acquisition.



shows up at the top of the screen, with:

- the pending block number, if relevant
- the current sampling rate
- the status of the data acquisition (stand-by, pending xx%, ...)
- the opening of a save file, if relevant
- a bargraph specifying the percentage of data acquisition achieved and the percentage of data acquisition displayed

5.9. Screen copy

You can create a file copying the content of the LCD screen:



You only have to press  at the top right of the screen.

The file will be created either onto the USB stick, if there is one, or into the internal memory.

The name of the file will be bmpxxxxx.bmp (incremental name).

In the internal memory, files are saved in the « FolderBMP » directory.

You can either copy this directory into an USB stick, or delete it.

You can also use a ftp link to recover these files.

6. TRIGGERS

This chapter describes all possible triggers of the appliance.

They are used by:

- the « configuration » menu, with the A and B alarms
- the « triggers » menu, with the start and stop parameters of the recording.

→ Edge/Level trigger

- Edge trigger: you need a change of status
 - *Example:* Channel A1, rising edge, threshold = 0V: triggers only if the signal status changes from negative to positive
- Level trigger: no need to pass the threshold
 - *Example:* Channel A1, high level, threshold = 0V: triggers only if the signal is positive
- Alarms only have level triggers.

→ Analogic / Logic channels: trigger only from analogic or logic channels

→ Single / Multiple threshold:

- triggering from only one threshold, or
- complex triggering from several channels and several thresholds; see description below.

Such complex triggering is only possible with analogic channels.

You can set-up these triggers thanks to the « trigger » menu in the homepage.



6.1. Analogic channel trigger

By pressing Start or Stop, you open the set-up window for the trigger of the start or stop of recording.

After selection of the trigger on Analogic Channels, the following line on screen allows you to set the trigger condition. It depends on the selection of single or multiple threshold.

6.1.1. Single threshold

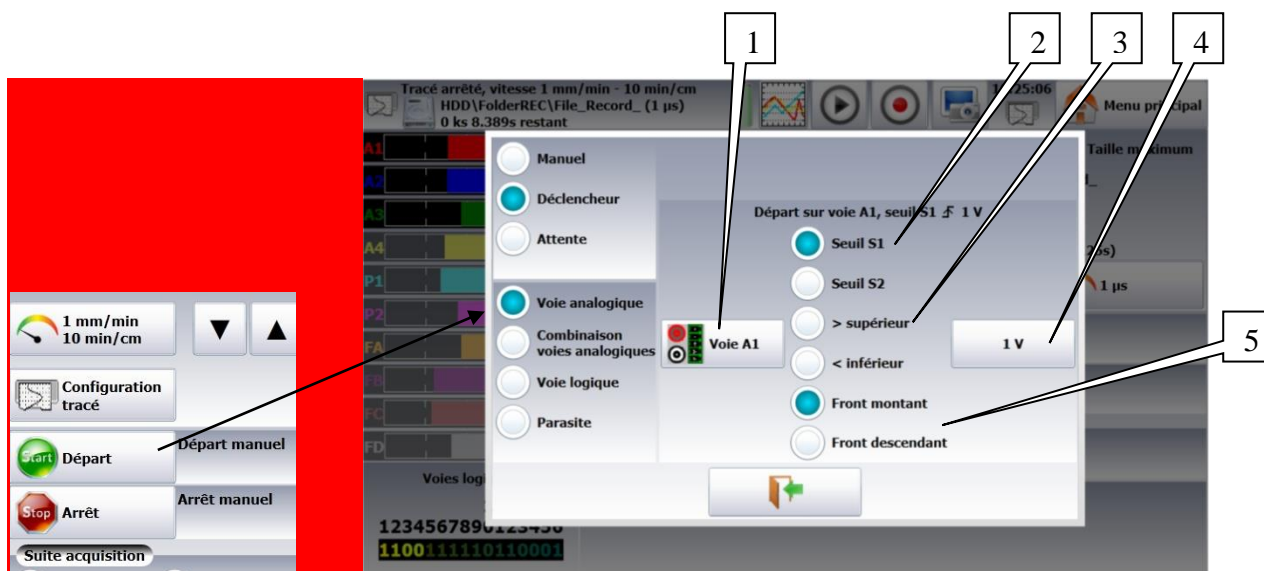

1- Channel: selection of the channel, on which the trigger threshold is applied

- 2- Threshold 1 / Threshold 2: selection of the threshold to settle; each channel is tested with reference with 2 thresholds, i.e. you can program a start condition on the channel A1 and the threshold 1, and a stop condition on this same channel A1 and the threshold 2.
- 3- Higher / Lower: trigger when the channel value is more or less than the set threshold.
- 4- Threshold value: threshold value selected in real value (taking the current unit and scale of the configuration of the selected channel into account)
- 5- Edge: Selection of the active edge of the channel in reference to the threshold.

6.1.2. Multiple thresholds

After selection of a trigger on a set of logic channels, the window allows you to set the trigger under several conditions.

Then, by pressing the various thresholds in front of their respective channels, you open the **threshold parameter window**.

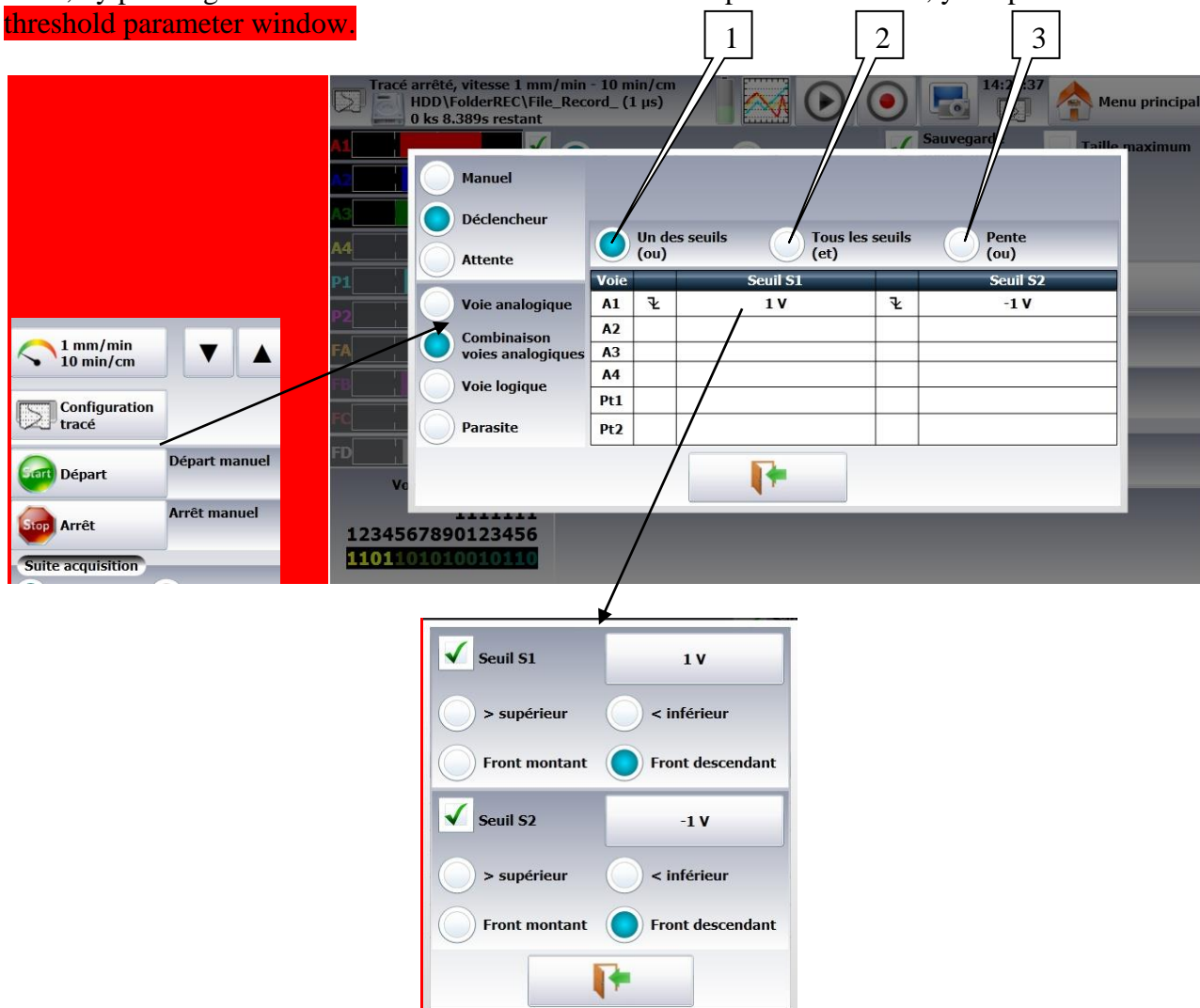

1- One of the thresholds (or): the first achieved condition activates the trigger

2- All thresholds (and): all conditions must be simultaneously achieved to validate the trigger

3- Slope (ou): trigger on the slopes of the signals; the first achieved condition validates the trigger

Example:

The trigger displayed above is:

Trigger if

Channel 1 decreasing and equal to threshold S1, value 1V OR
 Channel 2 decreasing and equal to threshold S1, value -1V

The same interpretation is valid for the AND trigger (all thresholds).

6.1.3. Parasites

You can trigger a parasite with a periodic 50Hz signal: trigger when the shape of the signal radically changes:

- parasite impulsion $>200\mu\text{s}$
- sudden change of frequency
- sudden change of shape



6.1.4. Trigger on Logic Channels

After selection of the trigger on Logic Channels, the window allows you to set the trigger condition.

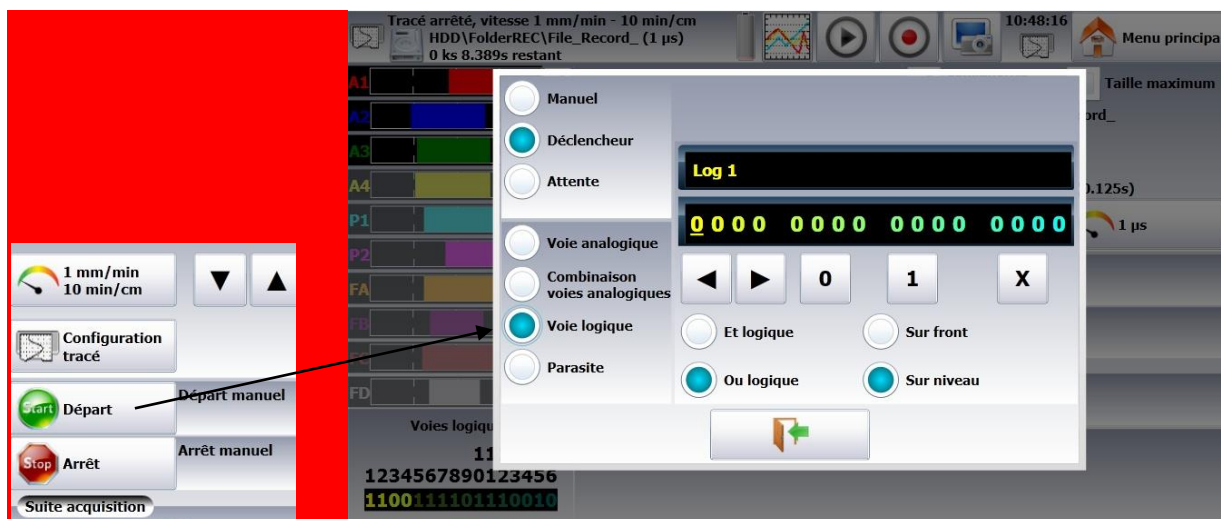

The 16 logic channels can be used in the trigger word:

- either active at status 0 (less than 1.6 volt)
- or active at status 1 (more than 4.0 volts)
- or non used X

- AND / OR: the logic function AND / OR is applied to each channel
- Type: edge or level: the trigger is applied on an edge (change of value) or a level

7. MATHEMATICAL CALCULATIONS

You can apply mathematical calculations on your data acquisitions.
 You can access them with the « **Direct display** » function.

7.1. Definitions

Press the « **Mathematical calculations** » key.

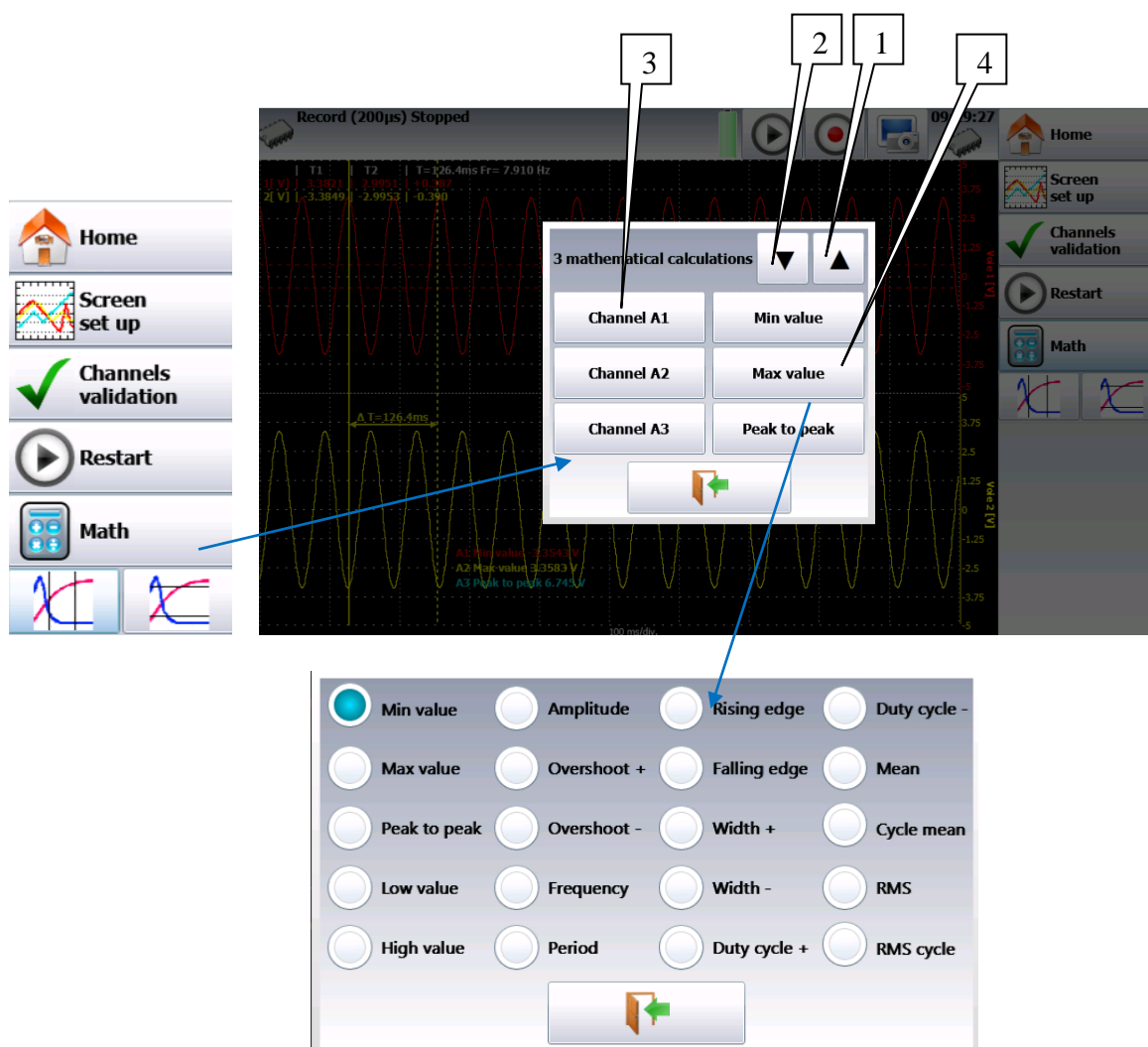

- 1- **Add:** add a mathematical calculation
- 2- **Remove:** remove one of the displayed mathematical calculations
- 3- **Channel:** selection of the channel on which the calculation is applied
- 4- **Function:** selection of the calculation function applied in the formula. You can change it by pressing directly on the type, which opens a window with all available calculations.

18 various mathematical formulas are available.

You can display up to **5 simultaneous calculations** on screen.

The display is made in windows above the diagrams, where are specified:





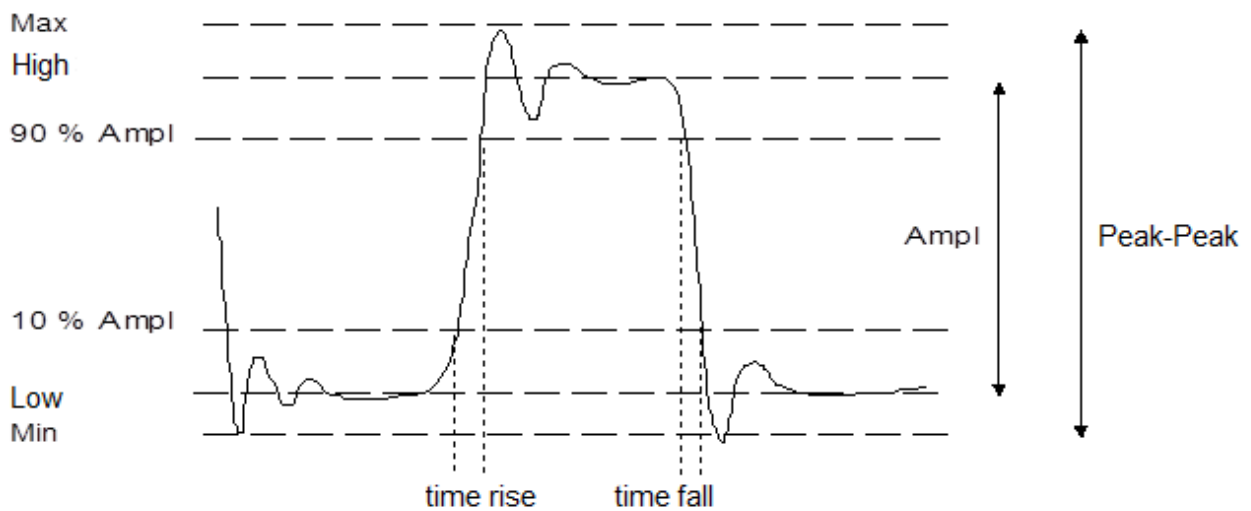

- the number of the channel (with its color)
- the type of calculation
- the value of calculation

Under « **Direct display** », calculations are made in real time and the display is updated every 300ms.

The calculation is made on the 1000 points displayed on screen. Hence, the time resolution is 0.1%.

7.2. Types of calculations

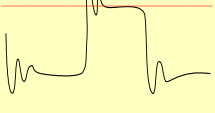
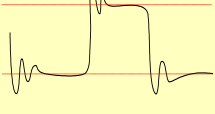

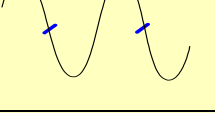
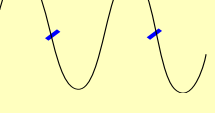
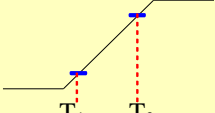
Drawing	Math function	Calculation	Observations
	Minimum		The lowest negative tension bottom
	Maximum		The highest positive tension peak
	Peak to Peak	Max – Min	
	Low		The most frequent value below the median
	High		The most frequent value above the median
	Amplitude	High – Low	
	On positive oscillation	$\frac{Max - High}{Amplitude} \times 100$	
	On negative oscillation	$\frac{Low - Min}{Amplitude} \times 100$	
	Frequency	$\frac{1}{Period}$	Average frequency
	Period	$\frac{Duration\ of\ N\ complete\ periods}{N}$	Average duration of a complete cycle calculated on as many periods as possible
	Rising edge	T ₁ = 10% Amplitude T ₂ = 90% Amplitude T _{rise} = T ₂ – T ₁	

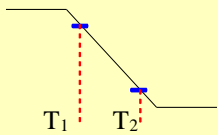
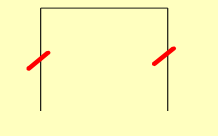
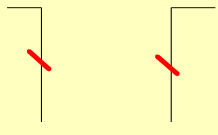
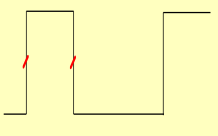
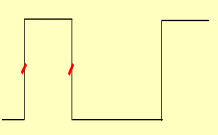
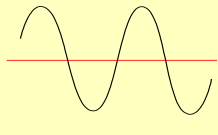
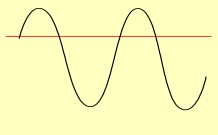
	<p>Falling edge</p>	<p>$T_1 = 90\%$ Amplitude $T_2 = 10\%$ Amplitude $T_{fall} = T_2 - T_1$</p>	
	<p>Width of positive impulsion</p>	<p>Measurement of the time of <u>1st positive pulse</u>. It is measured at 50% of amplitude</p>	
	<p>Width of negative impulsion</p>	<p>Measurement of the time of <u>1st negative pulse</u>. It is measured at 50% of amplitude</p>	
	<p>Positive cyclic ratio</p>	<p>$\frac{\text{positive pulse duration}}{\text{period}}$</p>	
	<p>Negative cyclic ratio</p>	<p>$\frac{\text{negative pulse duration}}{\text{period}}$</p>	
	<p>Average</p>	<p>$Aver = \frac{1}{N} \times \sum_{i=1}^N V_i$ N : total number of dots</p>	<p>Calculation on the whole graphic range</p>
	<p>RMS</p>	<p>$RMS = \sqrt{\frac{1}{N} \sum_{i=1}^N (V_i)^2}$</p>	<p>Calculation on the whole graphic range</p>

8. DIRECT MODE

This chapter describes the **Direct mode** of the recorder, designed to print out the measurements made on the channels in real time on heat-sensitive paper.



This mode does not exist on models without integrated printer

You can start and stop the print out under various conditions.
You can activate a simultaneous save of the measurements on file.

8.1. Launching the printing

Press  **Mode direct** OR  **Déclencheur**.

Programming the start and stop conditions of the print.

Selection of the actions after print and validation of the save in real time.

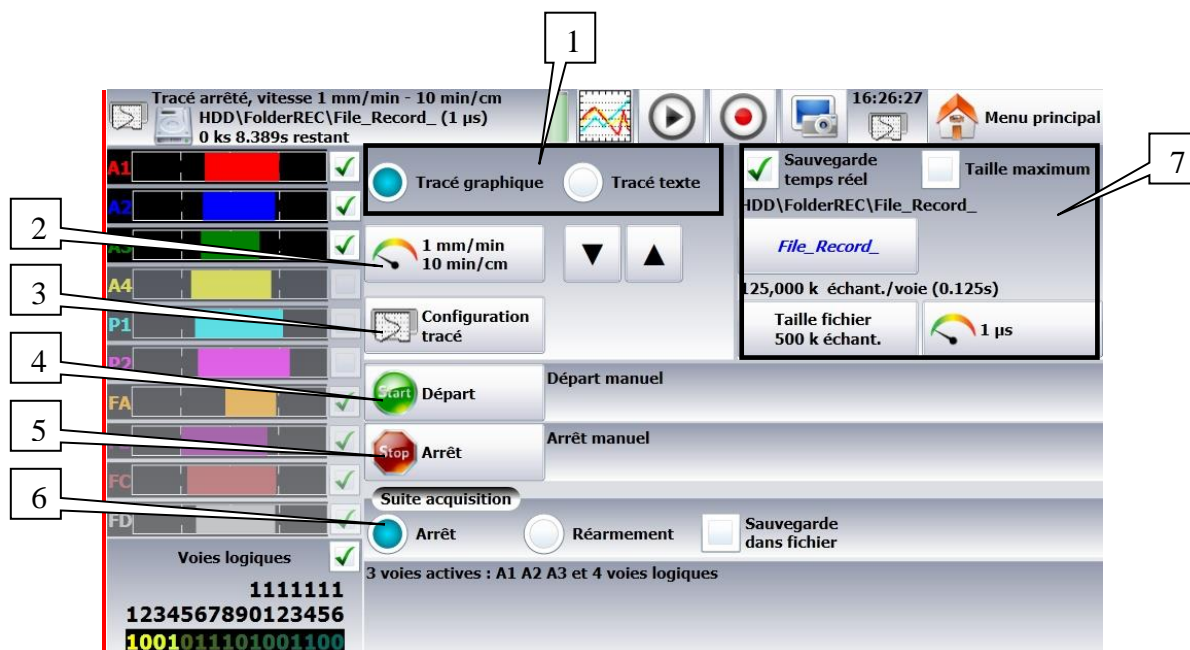

1- Mode: selection of the printing mode

- F(t): printing a graph as a function of time
- Digital: printing digital values of the measurements as a table

2- Paper speed: printing speed

You can change it from 10mm/min to 25mm/s.

3- Print configuration: see chapter 4.2

4- Start: start condition of the print



- Manual: with the  key
- Trigger: with a channel, with a combination of analogic and logic channels (see chapter 5)
- Stand-by: after a delay or at a precise date and time

5- Stop: stop condition of the print



- Manual: with the  key
- Trigger: with a channel, with a combination of analogic and logic channels (see chapter 5)
- Stand-by: after a delay or at a precise date and time
- Paper length: after printing a programmed length of paper

6- After acquisition: action after the end of the print; only possible if the start and stop triggers are not Manual

- Stop: no action
- Relaunch: waiting for the trigger Start
- Save to file: saving or not of the data acquisition into a file

7- Save: simultaneous record of the measurements into a file

- Simultaneous save: saving or not the simultaneous save
- File: record to a file
 - Name of the file: directory and name of the saving file
 - Acquisition period: sampling rate of the channels
 - Length of the max file.



See chapter **File mode** to know the restrictions of the recording on file.

- If an initial scroll speed has been programmed, the paper will scroll at that speed while waiting for a trigger.



- The operator can force a trigger any time by pressing  when waiting a start trigger.



- When printing, pressing  will stop the printer.

8.2. Configuration of print

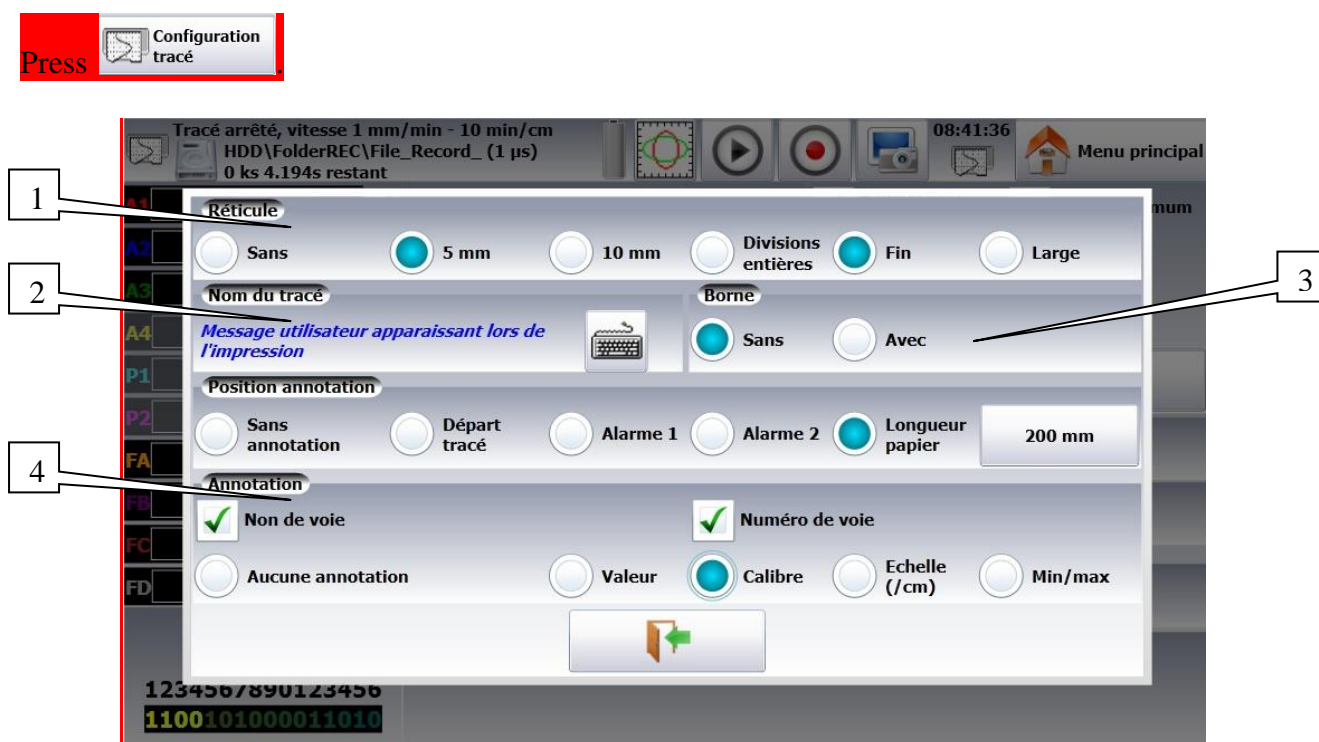

Definition of the specific characteristics of the paper printing:

- 1- **Reticule:** set-up of the reticule on paper
 - none, all 5mm, 10mm or per integer number of divisions
 - fine or wide, which means with or without subdivisions
 - access to the « Modification of diagrams » to set-up the display of channels on paper (see chapter **Diagrams**)
- 2- **Name of the plot:** set-up of a title (80 characters max.) for printing. It will appear on top of the paper.
- 3- **Boundaries:** possibility to note the boundaries of each channel (same as on screen) at the end of the print.
- 4- **Notes:** possibility to write notes while printing
 - without, at the beginning of the printing, on alarm, on a length of paper

8.3. Relaunching the printing

In relaunch mode, as soon as stop conditions happen, the appliance waits for new start conditions for the print out.



To terminate the cycle, you only have to force the interruption of the print by pressing during the print.

8.4. Writing information

At the beginning of each printing, the date and time and the programmed title appear at the top of the paper.

The number of each channel appears on the plot.

9. MEMORY MODE

This chapter describes the **Memory mode** designed to record in real time the measurement data made on the channels into the internal memory.

You can start and stop the data acquisition under various conditions.
You can simultaneously save measurements on file.

9.1. Set-up and start of the data acquisition

Press  Mode mémoire.

Set-up of the data acquisition into internal memory.

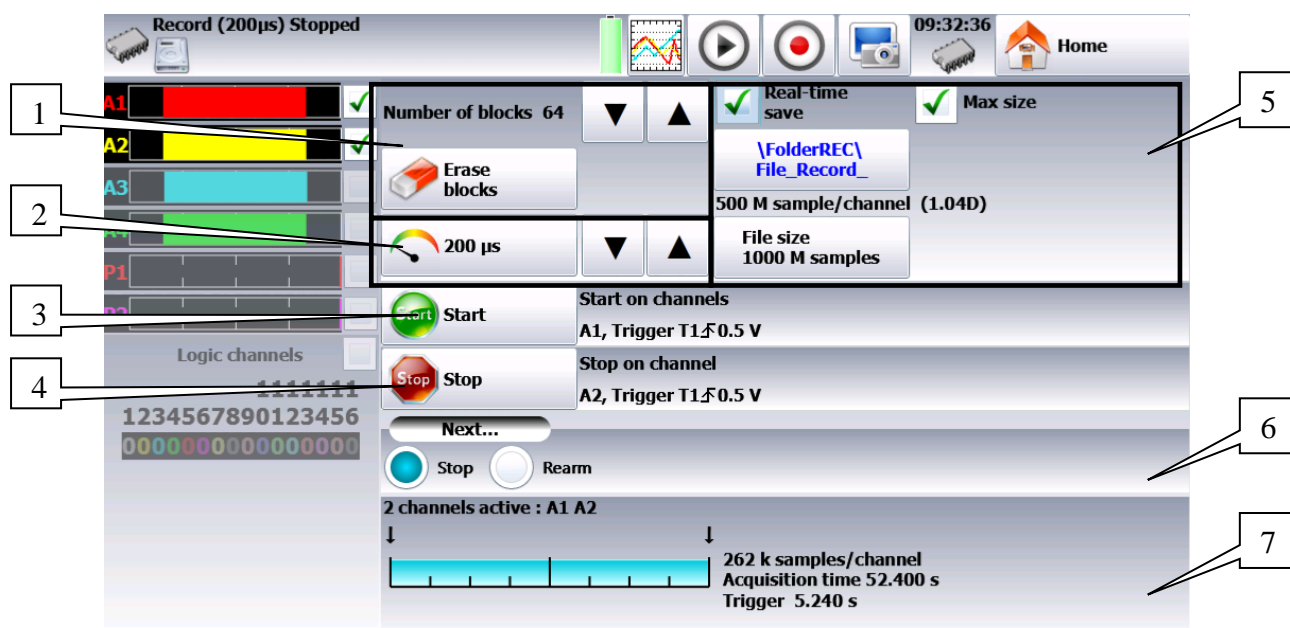

- 1- Blocks: parting of the internal memory in blocks
 - 1, 2, 4, 8, 16, 32, 64 or 128
 - Erase blocks: erasing of all blocks: the current block is #1
- 2- Acquisition period: sampling rate of the channels
 - internally paced from 1µs to 10min
 - externally paced by the logic channel 16

3- Start: start condition of the data acquisition



- Manual: with the  key
- Trigger: with a channel, with a combination of analogic and logic channels
- (see chapter 5)
- Stand-by: after a delay or at a precise date and time
- Automatic: immediate; automatic stop when the block is full

4- Stop: stop condition of the data acquisition

- Automatic: when the block is full
- Trigger: with a channel, with a combination of analogic and logic channels (see chapter 5)
- Trigger mode: Double Trigger; see the following chapter.

5- Real time save: simultaneous record of the data acquisition into a file

- directory and name of the saving file
- maximum length of the file

6- After acquisition: action after the end of the print; only possible if the start and stop triggers are not Manual

- Stop: no action
- Relaunch: waiting for the start trigger
- Save to a file: Saving or not the data acquisition into a file

7- View of the active channels, of the recording time, of the pre-trigger...

Pre-trigger: definition of the position of the Start trigger in the data acquisition

- data acquisition before and after trigger (before or after Start), and disabling of the trigger.

You can access this menu when setting a trigger by pressing

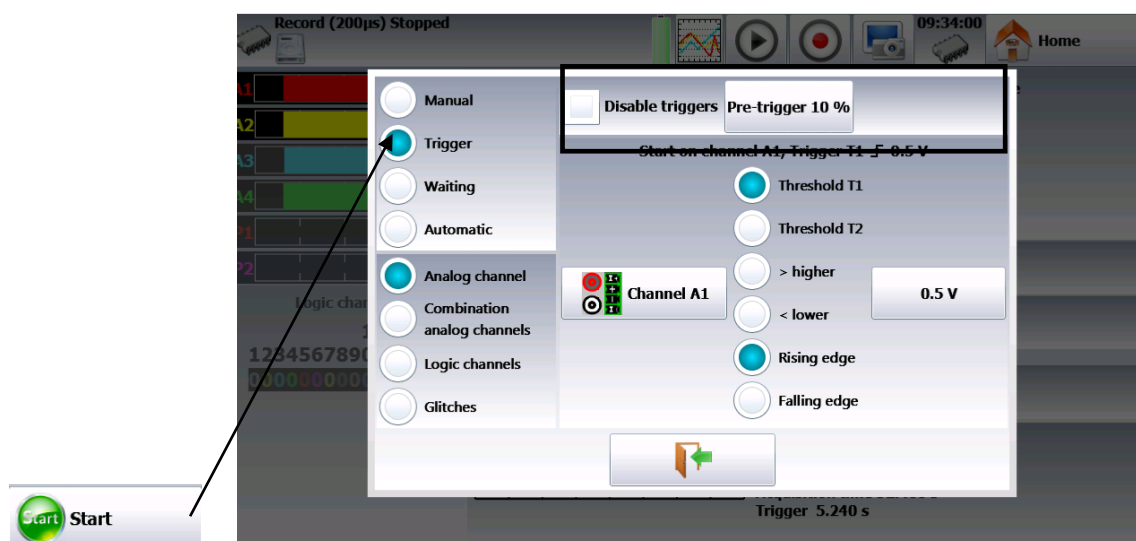



« **Impossible** » shows up when there is not enough place for saving data: you should reduce the sampling rate or the number of channels



See chapter **File mode** to know the restrictions of the recording on file.

9.2. Sampling period

When the frequency of the input signals is too high to record them in Direct mode, you must record the measurement signals into memory at high sampling rate: it is the **Memory mode**.

Sampling consists in recording the instant value of a signal at regular intervals and storing each of these values into a memory.

To get adequate acquisition of a periodic signal, you need to choose a sampling period compatible with the frequency of the signals present at the input terminals of the recorder.



A 10-dot per signal period definition is minimal for a satisfactory plot.

9.3. Internal memory, blocks

The available memory in the recorder can be shared into blocks that will be filled one after the other at each data acquisition.

The acquisition depth is worth $N / (B * V)$

N= total memory amount

B = number of blocks

V = number of channels to scan

Example: memory 32 Mwords, 16 blocks and 3 channels 'ON', we shall have:

$$N = 32\ 554\ 432 / (16 * 3) = 699\ 050 \text{ words/channel.}$$

Any new data acquisition goes automatically into the first free block (in increasing order).

When all blocks are full, any new data acquisition will shift the previous blocks from the N position into the N-1 position; the 1st block will be lost.

The new data acquisition will take the place of the last block.

9.4. Trigger position

The data acquisition into a memory block relies on the concept of « circular buffer »:

- the buffer is filled from the starting condition on
- the buffer is filled as long as the stop condition is not valid; when the buffer is full, it fills from the initial position of the buffer zone (block)

Thus, the memory block always contains the last N samples.

The operator can select when the samples in buffer will be frozen; to do so, you will select a delay between the trigger start and the beginning of the effective buffering.

This delay may be positive or negative: thus, buffered samples may be before, after or on both sides of the start moment.

You can also not inhibit the trigger: you will be able to test the trigger during the pre-trigger phase, in case the trigger should happen before the end of this phase.

In case of repetitive signals, the trigger should be inhibited.

Delay to memory input: -50%
from the 1st position of buffer

Delay to memory input: +50%
from the 1st position of buffer

9.5. Double Trigger mode

In this mode, you will use a start trigger and a stop trigger. Measurements between these two triggers shall be registered.

Data acquisition will stop automatically:

- when the stop condition is valid, or
- when the memory block is full.



An information window will sum up the general configuration of data acquisition:

- channels and functions between channels validated for data acquisition
- number of points per channel (as a function of the number of blocks)
- total data acquisition time (as a function of the acquisition speed)
- position of the trigger (as a function of pre-trigger phase)

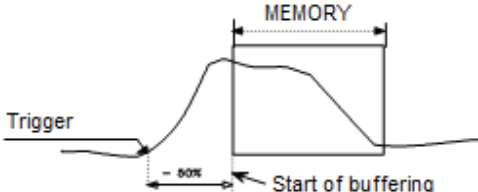
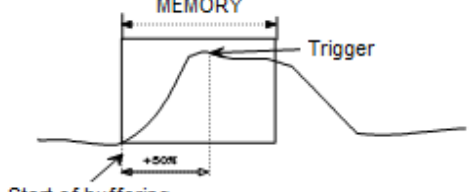

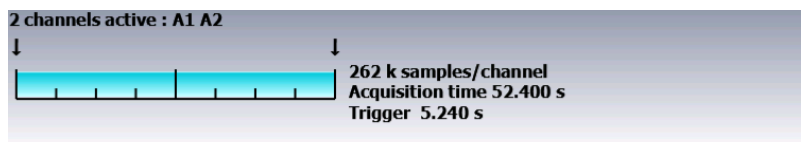
9.6. Recording



You launch the data acquisition by pressing  after pressing .

At the top left of the screen appear:

- the number of the pending block, if required
- the current sampling rate
- the status of data acquisition (waiting for trigger, filling xx%...)
- the opening of a save file, if required
- a bargraph showing the percentage of data acquisition made and the percentage of data acquisition displayed



Pressing  stops the pending data acquisition process.



If the acquisition time of the record is less than 2 minutes, you will see the whole data acquisition.

Then, you won't be able to leave this page: only when the acquisition stops can you change of menu.

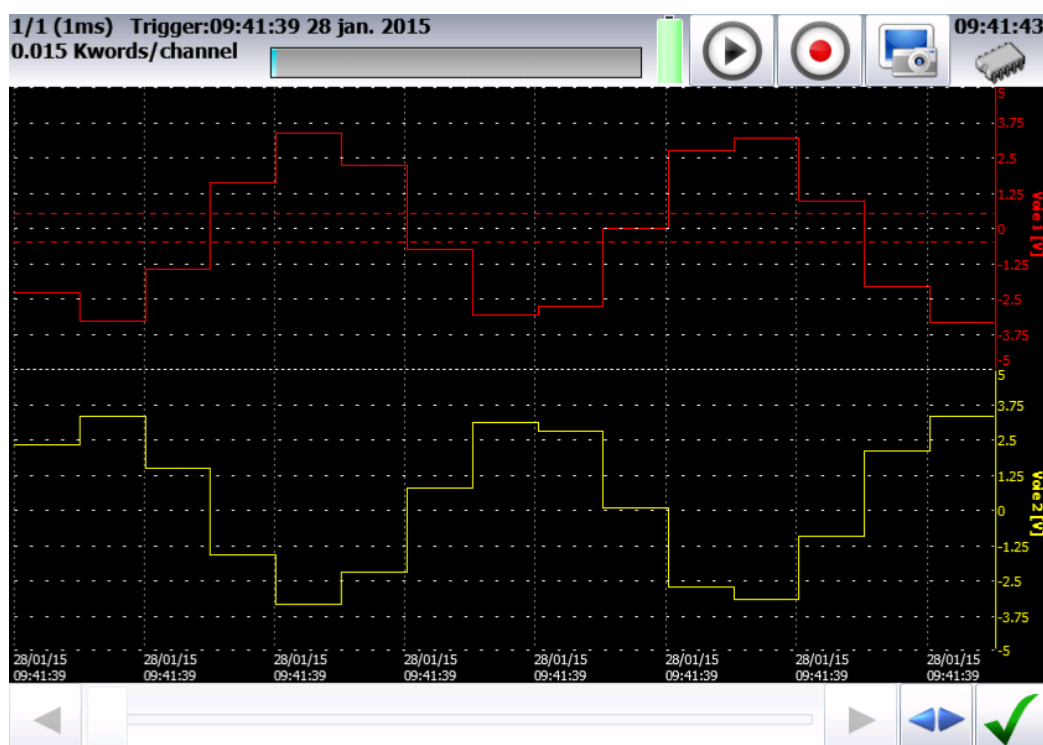



For longer acquisition time, you can zoom onto a part of the data or change of page.



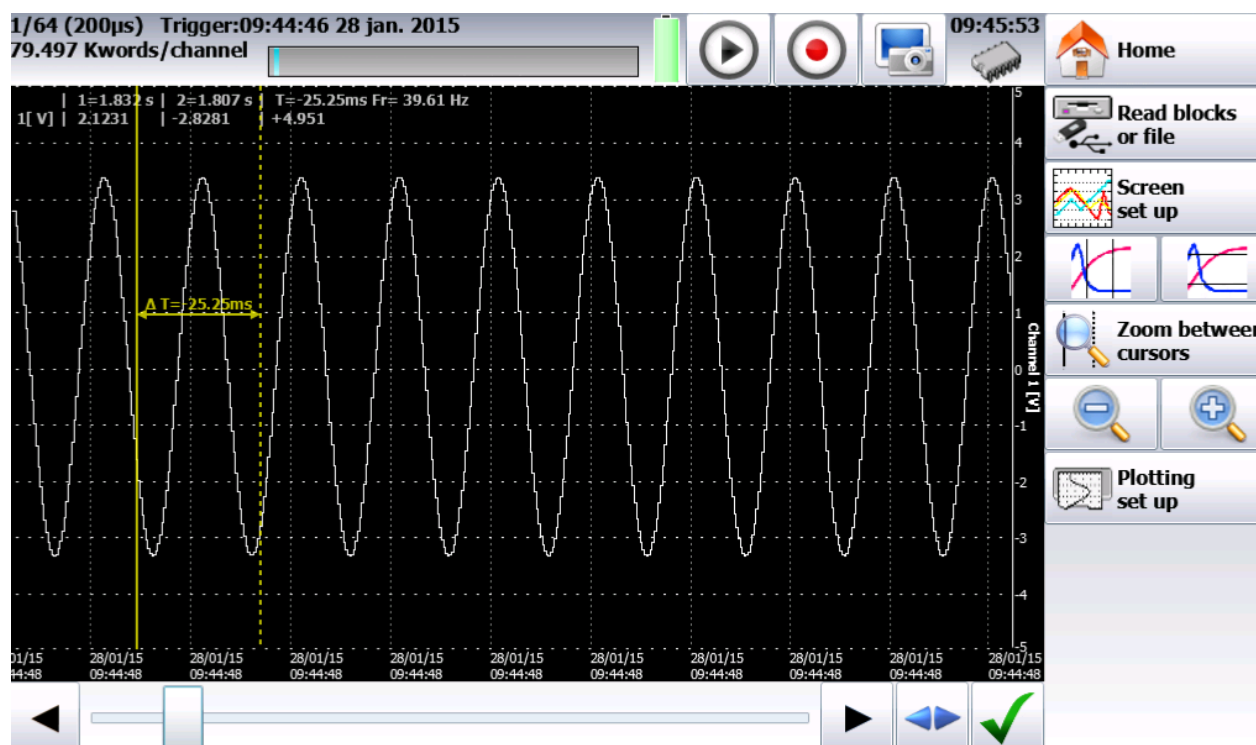

When changing of menu page, you can return to data acquisition by pressing



Additional menu keys:

➔ Display:

- Total : the whole memory is displayed and refreshed during the data acquisition.
- Partial : only a part of the memory is displayed; the screen is frozen; only the bargraph and the filling rate show the status of data acquisition; you have access to time cursors and zooms.



You cannot visualize a block else than the current one, draw a plot or save the data acquisition into a file as long as the current data acquisition is not finished.

9.7. Memory output



You can access the « memory output » mode by pressing .
Display of the data acquisitions available in the internal memory or in files.
Possibility to start the paper printing of the data acquisitions.

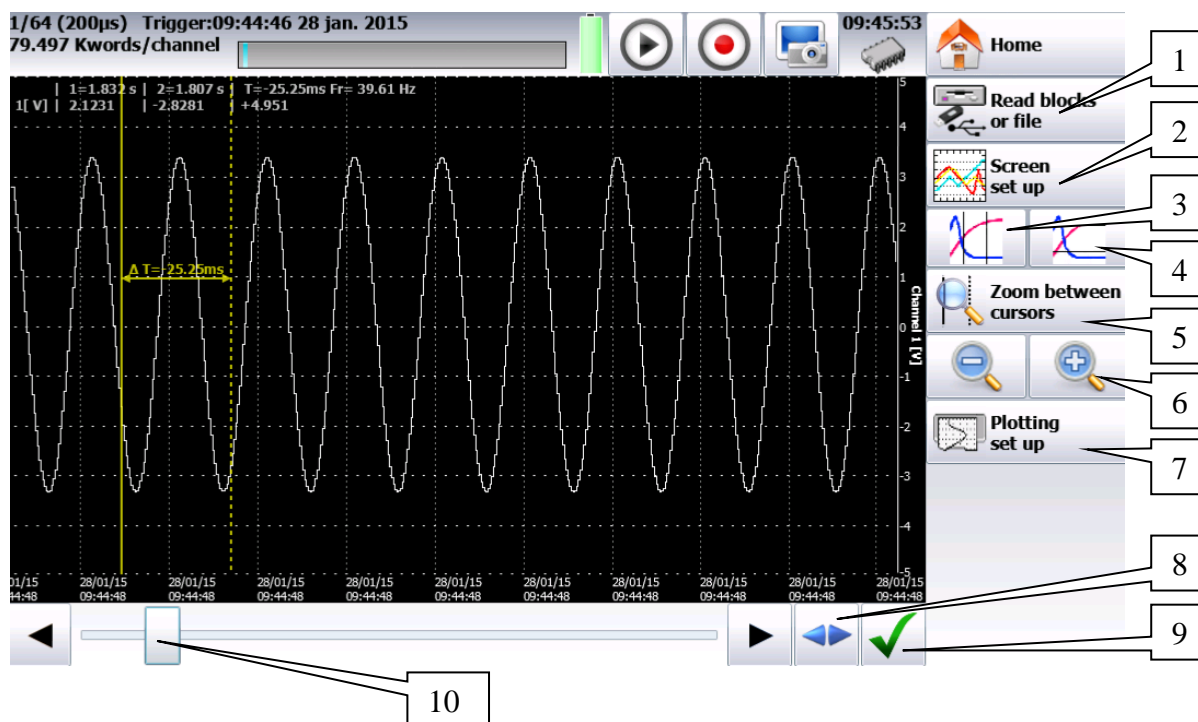

- 1- Read blocks or file: selection of the memory block or of the file to display; if there is no valid block, the only menu key available will be « Load file »
- 2- Screen set-up: type of display, diagrams; see chapter Use
- 3- Time cursors: vertical cursors, zoom
- 4- Tension cursors: horizontal cursors
- 5- Zoom between cursors: allows a zoom between the positioned cursors
- 6- Zoom + & Zoom -: allow zooming or not onto a part of the data acquisition
- 7- Plotting set-up: configuration of the data acquisition drawing; « Launch plot » key
- 8- Total display of the data acquisition
- 9- Validation of the buffered channels to display
- 10- Cursor for scrolling along the data acquisition.

The upper window displays:

- the number of the displayed block
- the sampling rate of the block
- the date of trigger
- the number of points per channel in the block
- a bargraph showing the filling level of the block and the position of the trigger

10. TEMPLATE MODE

This chapter describes the **Template mode** designed to record in real time the measurement data made on the channels into the internal memory.

You can start the data acquisition under various conditions. It **stops** when the measurement values go out of a range defined by a previous data acquisition called **Template**.

A simultaneous save of the measurements onto a file can be activated.

10.1. Set-up and launching of the data acquisition

Press 

Set-up of the data acquisition as a template into internal memory.

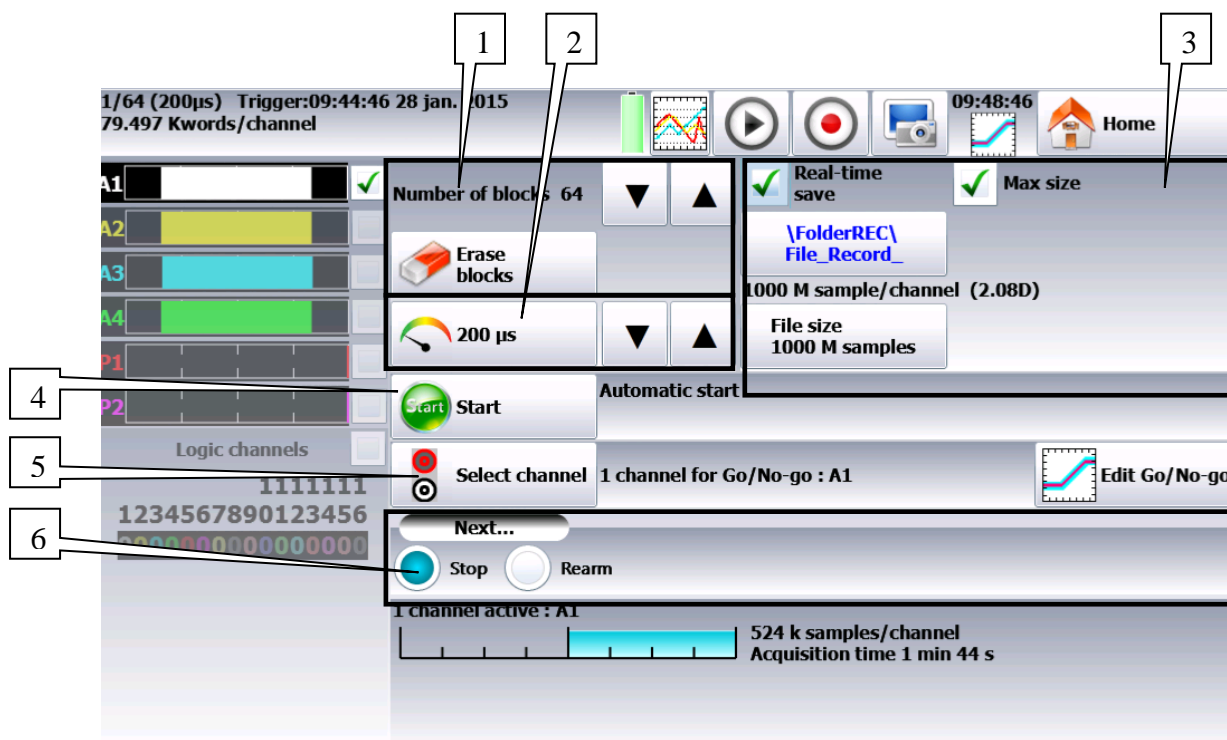

- 8- Blocks: parting of the internal memory in blocks
 - 1, 2, 4, 8, 16, 32, 64 or 128
 - Erase blocks: erasing of all blocks: the current block is #1
- 1- Acquisition period: sampling speed of the channels
 - internally paced from 1 μ s to 20min
 - externally paced by the logic channel 16
- 2- Real time save: simultaneous record of the data acquisition into a file
 - directory and name of the saving file
 - maximum length of the file
- 3- Start: start condition of the data acquisition
 - Manual: with the  key.
 - Trigger: with a channel, with a combination of analogic and logic channels (see chapter 5)
 - Stand-by: after a delay or at a precise date and time
 - Automatic: immediate; automatic stop when the block is full
- 4- Template channels: channels to compare with the template; access to the set-up of the template
- 5- After acquisition: action after the end of the print
 - Save file: save the data acquisition into a file if the Real Time save has not been validated (or is impossible)
 - Draw: plotting the data acquisition
 - Stop: no other action
 - Relaunch: waiting for the Start trigger
 - Change set-up: loading a configuration and waiting for the Start trigger





« **Impossible** » shows up when there is not enough place for saving data: you should reduce the sampling rate or the number of channels



See chapter **File mode** to know the restrictions of the recording on file.

10.2. Creation of the template

Make a data acquisition into memory.

Press  **Trigger**, then select .

The appliance displays the current template. It is marked as 2 curves (a min. curve and a max. curve) around the channel selected as a reference for the template.

The 2 curves are saved in internal ROM.

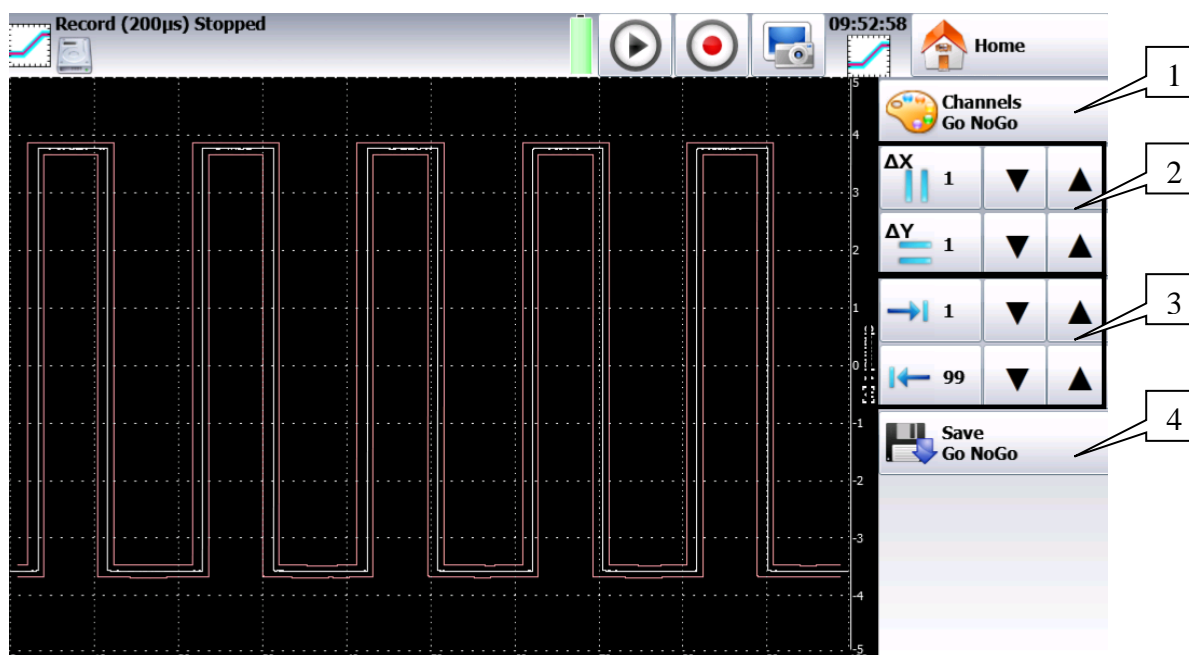



- 1- Channel: allows the selection of the reference channel
- 2- DX & DY: allow you to build the min. and max. curves
- 3- Begin & End: limits of the memory extent where the trigger test shall be made
- 4- Save Go/NoGo: as soon as the template is correct, you can save it into the internal ROM.



You cannot save a template on a **file**. To save a template on a file, save the block and the channel in order to recreate the template for reuse.

Use of the template

The comparison with the template is the stop criterion of the data acquisition. This comparison shall be made with the « **Template Channels** » selected in the  page.

The information window at the bottom of the page  sums up the general configuration of the data acquisition:

- channels and functions between validated channels for data acquisition
- channels and functions between channels compared to the template
- number of points per channel (as a function of the number of blocks)
- total data acquisition time (as a function of the acquisition speed)
- position of the trigger (as a function of pre-trigger phase)



 The comparison to the template is only possible when the channels are validated for data acquisition. An error message shows up if you have selected « Template Channels » that have not been validated.

The data acquisition is made as above (see chapter **Memory Mode**).

When the memory block is full, the appliance checks that all measured points on the template channels are between the 2 min. and max. reference curves constituting the template.

If all points are between the curves, the data acquisition restarts (in the same block). If not, the data acquisition stops.

11. FILE MODE

This chapter describes the **File Mode** designed to record in real time the measures made on the channels.

The start and stop of the plot can be triggered under various conditions.

11.1. Set-up and triggering of the data acquisition

Press .

Set-up of the data acquisition into a file.

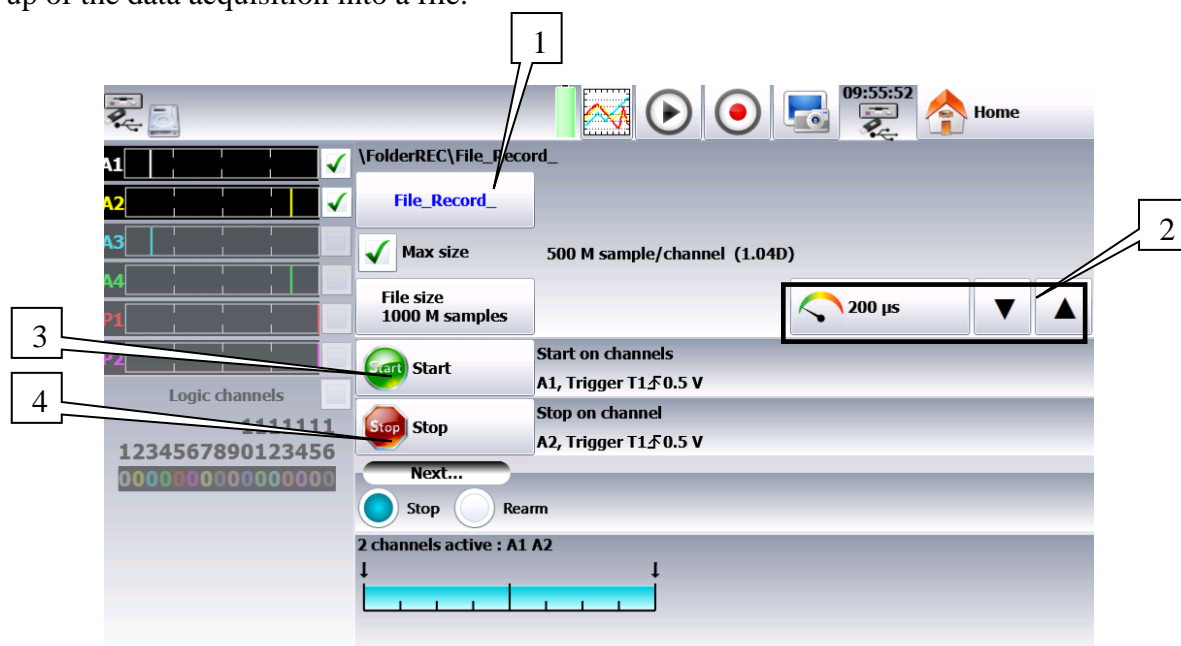

- 1- File name: directory and name of the data acquisition file
 - Directory of the data acquisition file
 - Name of the data acquisition file
- 2- Acquisition period: sampling speed of the channels
 - internally paced from $1\mu\text{s}$ to 20min
 - externally paced by the logic channel 16
- 3- Start: start condition of the data acquisition



- Manual: with the  key
- Trigger: with a channel, with a combination of analogic and logic channels (see chapter 5)
- Stand-by: after a delay or at a precise date and time

- Automatic
- 4- Stop: stop condition of the data acquisition
- Automatic: when the disk is full
 - Trigger : with a channel, with a combination of analogic and logic channels (see chapter 5)

Trigger mode **Double Trigger**; see chapter **Memory mode**.

11.2. Restrictions

Real time data acquisitions to a file are limited by the transfer rate between the inputs and the saving means of the internal memory or USB sticks.

It is advisable no to create too big files, because reading them may be very long. It takes ca. 3 minutes to read a 200Mo file.

The minimum transfer rate to the flash disk is 100 Kwords/s (10 μ s)

To know the number of channels you can record at a given acquisition period, calculate:

- number of channels = 100 000 x acquisition period
example: at 20 μ s, the number of channels is max. 2.

12. NETWORK ANALYSIS

12.1. General

The recorder also includes a network analysis function. It allows power and harmonics measurements. Measured values can be viewed in real time or delayed.



You can also record the available logic channels and channels.

You can access the network analysis menu with the  key.

The set-up page shows up. It lets you access various parameters:

- Description of network and wiring
- Selection of the type of analysis and of the desired values

You can also access other menus:

- Visualization (Oscilloscope, Digital, Harmonics):  key.
- Acquisition:  key.



Attention:

The connections of the inputs on the installation to test shall be made by a duly authorized personal.

12.2. Network set-up

In the main menu, change of mode by pressing . You directly access the set-up page.

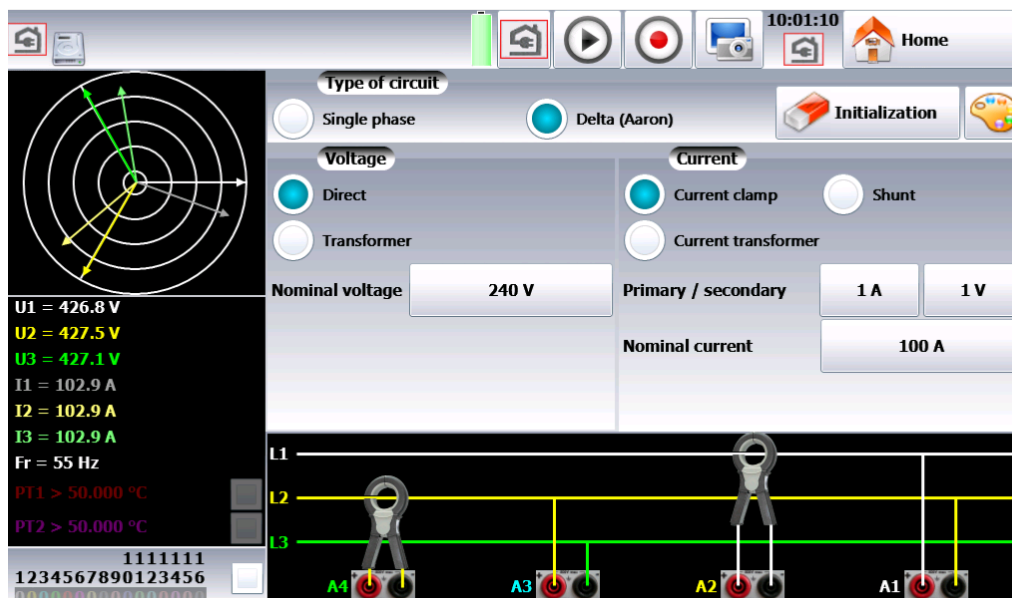

Select the basis configuration of the network:

- single-phase
- three-phase mode Aaron: Only 2U and 2I are used. The 3rd phase is re-calculated (for DAS50 only): (method of the double-wattmeters).

The  key allows you to set up the channels in a basis configuration:

- Tension measurement: « Direct » or « Transformer ». If the network tension is measured through a transformer, select this set-up and enter the transformation ratio
- The appliance automatically selects the right caliber; you only have to specify the nominal tension of the networks. Beware: if this value is too different from the real tension, this may lead to uncertainty and measurements over the caliber
- Current measurement: The same is worth as for tension measurement; you select the current type of input (clamp, shunt, transformer). In each configuration, you have to enter the associated parameters.
- For "clamp": primary current, secondary tension (these are current / tension clamps)
- For "transformer" (transformer + shunt): primary and secondary currents and value of the shunt
- For "shunt": value of the shunt, in ohms
- You also have to set the nominal current and tension
- Data acquisitions are synchronized with the calculation of frequency of channel 1.

Wiring and check:

Direct display of the network wiring. Any wrong wiring may lead to wrong results.
The colors of the channels match the colors of the respective inputs.

The tension inputs U1, U2 are connected to the terminals 1 and 3

The current inputs I1, I2 are connected to the terminals 2 and 4

**Fresnel diagram:**

You can also check if the wiring is right by displaying the Fresnel diagram. The length of the arrows is not proportional to the efficient value of the currents: the user will have to check that what he sees is coherent.

The position of the tension arrows is calculated with reference to the tension V1.

Attention: the angles are those of the tensions/currents representative either of the shape factor or of the fundamental values.

You can check whether the connection is direct or reverse. Intensity vectors are calculated in reference to the corresponding tensions.



Attention: even if nothing abnormal appears, there may be mistakes. In any case, the wirings must be made with caution by a qualified personal.

Warning messages:

Messages may appear in red any time at the top of the screen:

- Impossible to synchronize the signal: the frequency is wrong, the signal is too weak or too noisy
- Caliber exceeded: The tension or the current are too high for the theoretical nominal value: you must change this value or use another probe.

Recording additional channels:

You can record additional channels by checking channels to record in the set-up of your network analysis. The number of channels will change as a function of the network (single phase: more additional channels, three phases: less additional channels):

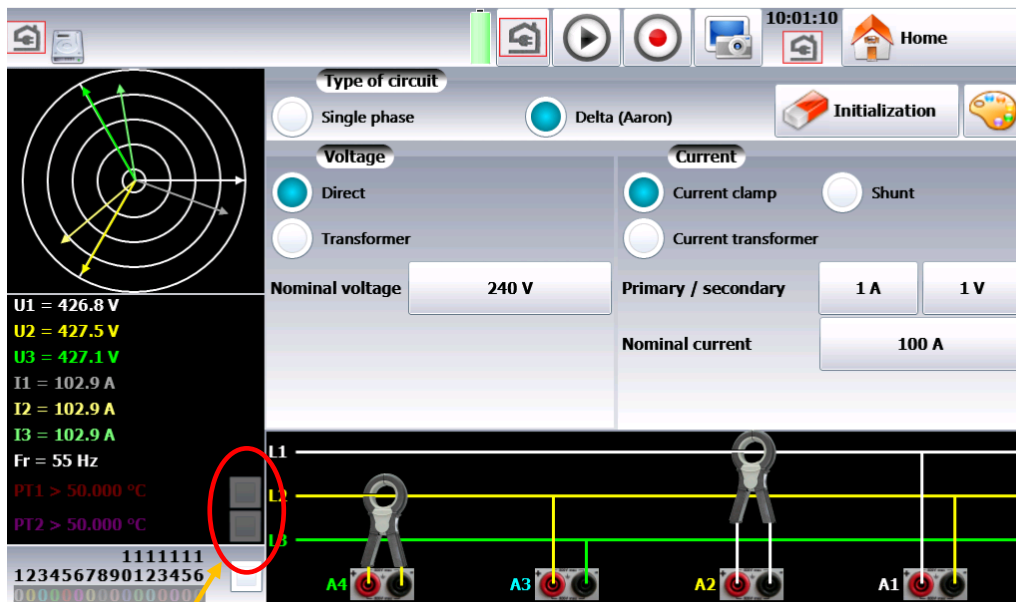

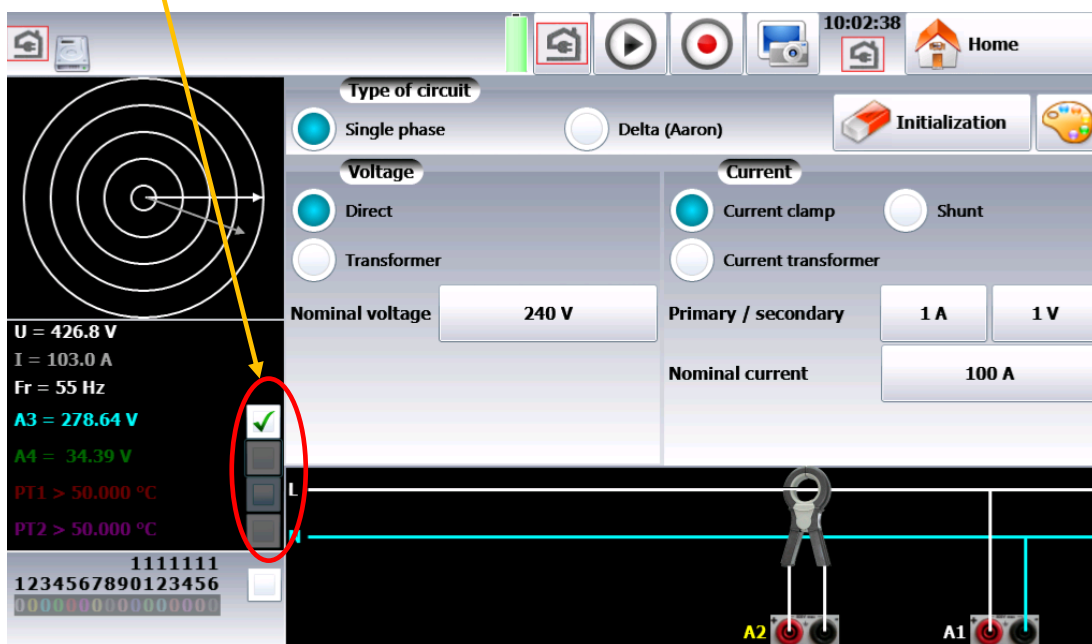

Validation of the additional channels

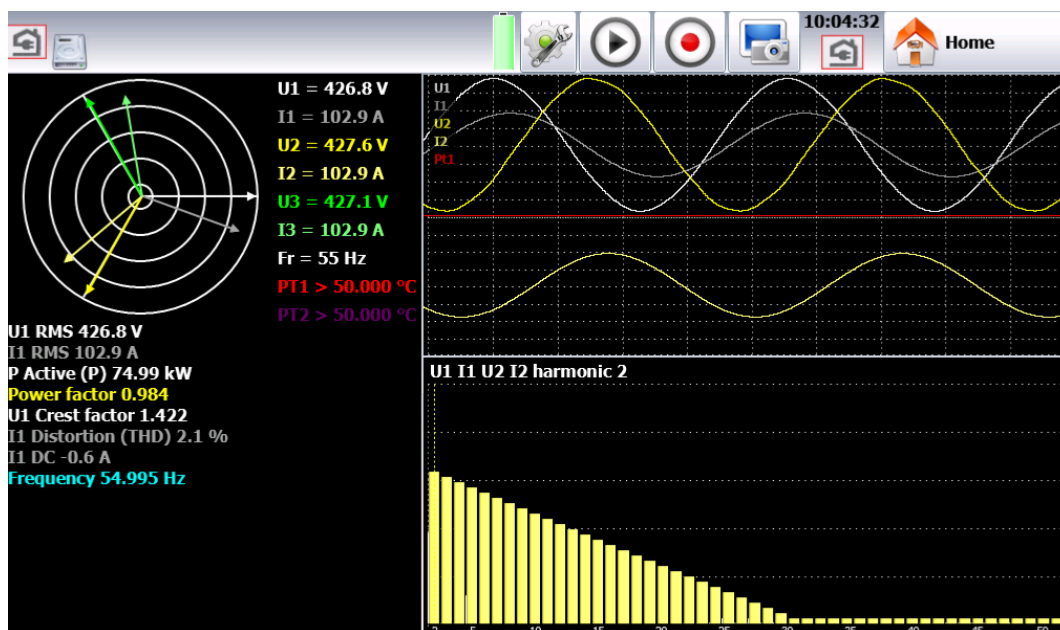

12.3. Real time display of the signals



By pressing , you have access to the following windows. You have access to this page even during data acquisition.

Each of these windows can be invalidated by pressing .

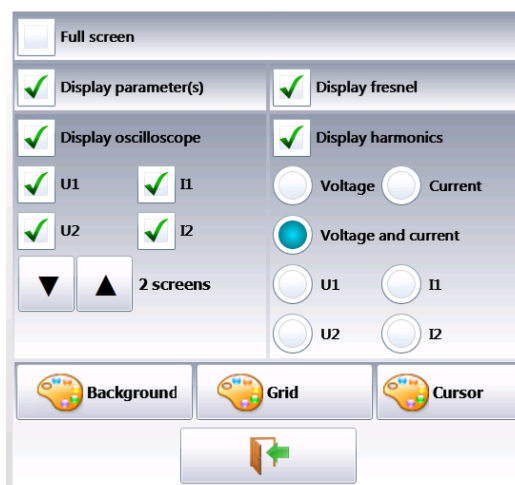

- Fresnel diagram: display of the signal and of the RMS values of the inputs and of the frequency.
 - Oscilloscope: This mode allows you to know the true shape of the signals; hence, it will help you detect wiring mistakes.
 - The time basis depends on the frequency of the signal (at least one alternation)
 - You can change the reticules and the position of the displayed channels.
- ➔ Harmonic display: This window is updated ca. once a second.

- Selection of the channels: you select either all the tension channels (U1, U2) or all current channels (I1, I2) or all network channels (U1, U2 + I1, I2) or only one channel (these channels are also used to record harmonics).
- Sampling frequency: 200µs
- Number of points: 2048
- A cursor allows you to display the value of the selected harmonic

➔ Parameters: display of the values of each parameter.

At any moment, you can copy the screen into a bitmap file (on a hard disk or a USB stick) by

pressing .

12.4. Power analysis set-up

Once the appliance is set up, you still have to set the type of measurement to make: you can make a power analysis or an energy analysis.

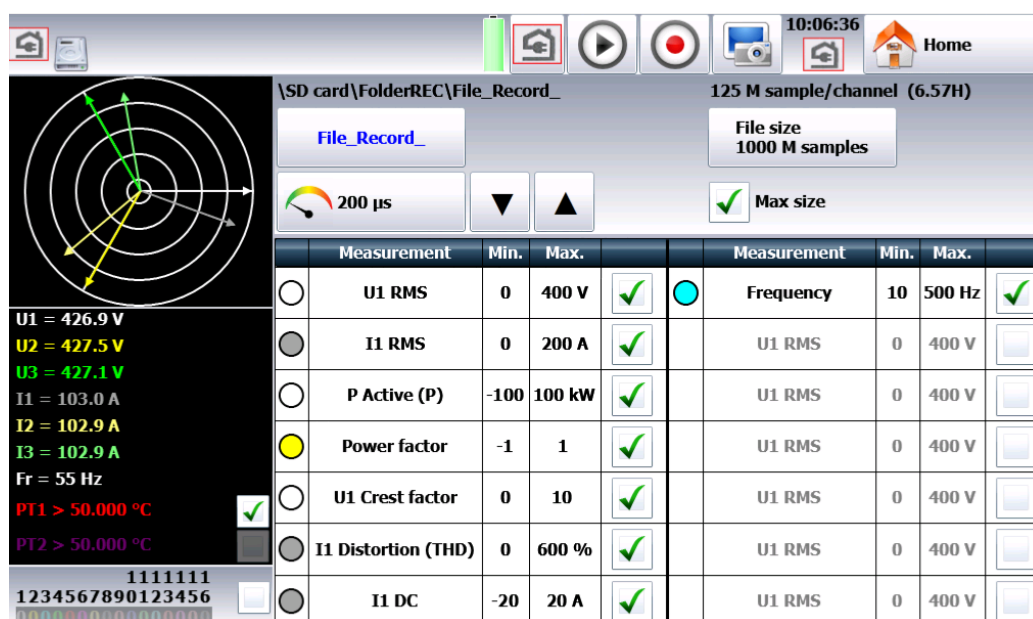

SD card\FolderREC\File_Record_ 125 M sample/channel (6.57H)

File size 1000 M samples

200 µs

Max size

	Measurement	Min.	Max.		Measurement	Min.	Max.	
<input type="radio"/>	U1 RMS	0	400 V	<input checked="" type="checkbox"/>	Frequency	10	500 Hz	<input checked="" type="checkbox"/>
<input type="radio"/>	I1 RMS	0	200 A	<input checked="" type="checkbox"/>	U1 RMS	0	400 V	<input type="checkbox"/>
<input type="radio"/>	P Active (P)	-100	100 kW	<input checked="" type="checkbox"/>	U1 RMS	0	400 V	<input type="checkbox"/>
<input checked="" type="radio"/>	Power factor	-1	1	<input checked="" type="checkbox"/>	U1 RMS	0	400 V	<input type="checkbox"/>
<input type="radio"/>	U1 Crest factor	0	10	<input checked="" type="checkbox"/>	U1 RMS	0	400 V	<input type="checkbox"/>
<input type="radio"/>	I1 Distortion (THD)	0	600 %	<input checked="" type="checkbox"/>	U1 RMS	0	400 V	<input type="checkbox"/>
<input type="radio"/>	I1 DC	-20	20 A	<input checked="" type="checkbox"/>	U1 RMS	0	400 V	<input type="checkbox"/>

U1 = 426.9 V
 U2 = 427.5 V
 U3 = 427.1 V
 I1 = 103.0 A
 I2 = 102.9 A
 I3 = 102.9 A
 Fr = 55 Hz
 PT1 > 50.000 °C
 PT2 > 50.000 °C

1111111
 1234567890123456
 0000000000000000

12.4.1. Parameter acquisition file

You should first set the sampling period and the directory of the file.

There is no trigger: as soon as the record is launched, the values of the parameters are saved in real

time into the file; the data acquisition stops when pressing  in the acquisition page.

12.4.2. Recordable parameters

- ➔ Number of observed values: you can select it under "Number of parameters". The possible values range from 1 to 14.
- ➔ Selection of values: you can select:
 - Tension and Current:
 - Efficient RMS : efficient value
 - Fund fund : efficient value of the fundamental
 - Average dc : average value (DC offset)
 - Peak cr : maximum value between the max and min peaks
 - Peak factor fcr : ratio between the peak value and the efficient value (1,414 for a sinusoidal signal)
 - Total harmonic distortion THD: ratio of the total presence of harmonics to the fundamental component of the signal
 - Distortion factor DF: DF% is the ratio of the total presence of harmonics to the true efficient value of the signal.
 - Power:
 - P : Active
 - Q : Reactive
 - S : Apparent
 - Energy: cumulative value; you will find an initialization at page « Display »
 - FP : power factor:
 - F.P. : power factor
 - Cos phi : cosine between the fundamental components of the signals U1 and I1,
 - Frequency: the calculation of frequency is made at the input U1.
 - Standard data acquisition channel: you can select among the free channels.

For tension, current and power, you can select each line (ex. U1, P2, I2) or the global value of the network (Ut, It, Pt)

For each parameter, you can change the following values:

- ➔ Validity: / : allows you or not to display a parameter as a graph; the parameters will always be recorded; only the graphic display is changed.
- ➔ Color: color of the displayed parameter in the graph; for the additional channels and the logic channels, the colors are as set up for each of them
- ➔ Caliber: the caliber is defined by the nominal values of the tensions and currents. For example, for a nominal tension of 230V, the caliber shall be 400V centered on 200V (hence, between 0 and 400V); the minimum and maximum values may be changed for finer display. For example, you will be able to display the signal U1 between 220V and 240V.

12.5. Record

You launch the data acquisition by pressing . There is no trigger: the record is made in real time, directly on the disk.

During the data acquisition, you cannot change the parameters of data acquisition, but you can change the display parameters (zoom, color, display validity...).

You can also display signals in scope mode or display the parameters in digital mode.



To stop the data acquisition, press .

12.6. Measurement process

Efficient values:
$$X_{rms} = \sqrt{\frac{\sum_{k=1}^N x_k^2}{N}}$$

Average values:
$$X_{mean} = \frac{1}{N} \sum_{k=1}^N x_k$$

Active powers:
$$P = \frac{1}{N} \sum_{k=1}^N v_k * i_k$$

Apparent powers:
$$S = U * I$$

Reactive powers:
$$Q = \sqrt{S^2 - P^2}$$

Power factor:
$$FP = \frac{P}{S}$$

Peak factor:
$$Fc = \frac{X_{peak}}{X_{rms}}$$

Total harmonic distortion:
$$THD = \sqrt{\frac{X_t^2 - X_{fund}^2}{X_{fund}^2}}$$

Distortion factor:
$$DF = \sqrt{\frac{X_t^2 - X_{fund}^2}{X_t^2}}$$

Total active power:
$$P_T = P_1 + P_2 + P_3$$

Total reactive power:
$$Q_T = Q_1 + Q_2 + Q_3$$

Total apparent power:
$$S_T = \sqrt{P_T^2 + Q_T^2}$$

Total tension:
$$U_T = \sqrt{\frac{U_1^2 + U_2^2 + U_3^2}{3}}$$

Total intensity:
$$I_T = I_1 + I_2 + I_3$$

Power factor:
$$FP_T = \frac{P_t}{S_t}$$

Energy: cumulative value of power P; this value is reset in the Visualization page.

Attention: the maximum value of energy during the data acquisition is restricted to $E = P_n * H$, where

P_n = nominal power

H = 12 hours.

13. FILE MANAGEMENT

13.1. General

For all possible files, the appliance has an internal flash disk available and may accept an USB stick, which makes it possible:

- to save and load the total configuration of the recorder
- to save or restore a data acquisition.

The names of the set-up files have a « cnf » extension.

The names of the data acquisition files have a « rec » extension.

You can create directories and save the files into them.

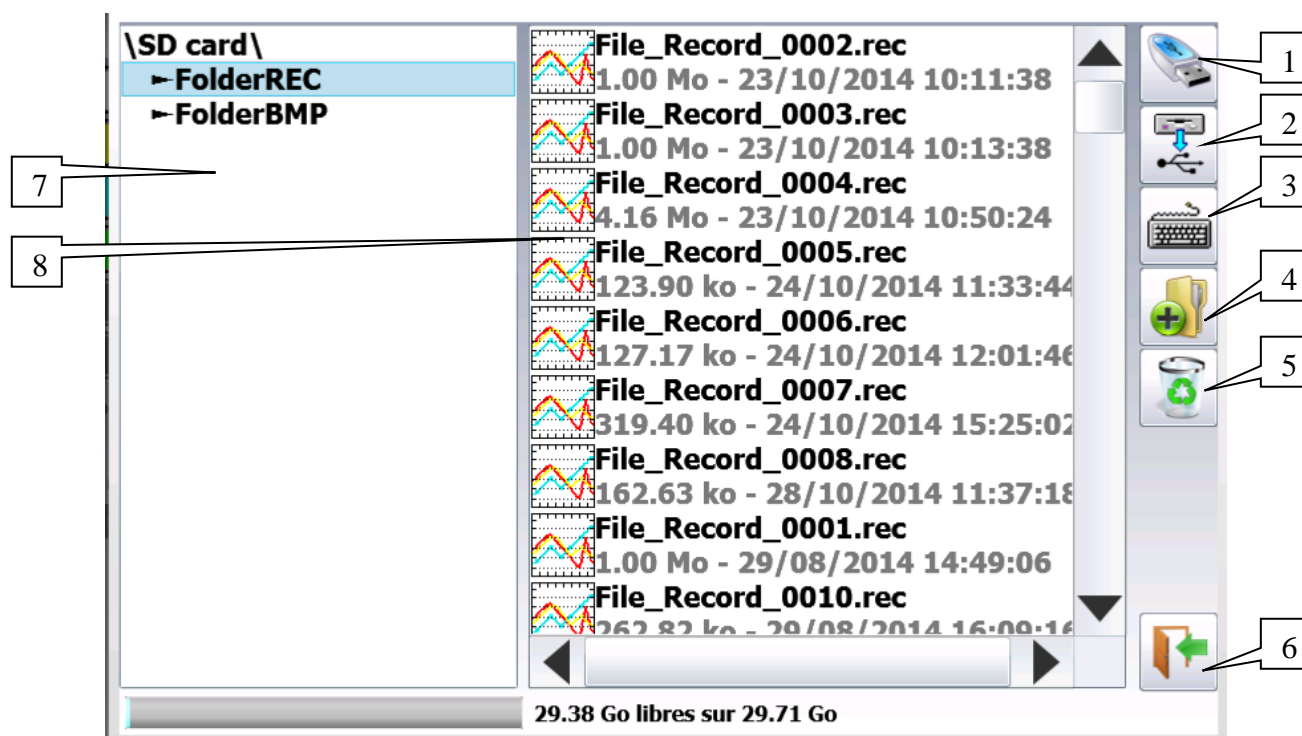

- 1- **HD / USB stick:** read/write into the internal flash disk or an USB stick (if it was connected at the start of the appliance)
- 2- **Copy of a file to USB:** copy the selected file or directory to an USB peripheral
- 3- **Type the name of a new file**
- 4- **Create directory:** creation of a new directory; you can type its name with the alphanumerical keyboard displayed on screen
- 5- **Erase:** erases the selected directory or file
- 6- **Close the window**
- 7- **Selection of the directory window:** Allows you to select the directory to work with
- 8- **Selection of the file window:** Allows you to select the file to work with



It is highly advisable to work in a directory and not at the root of the flash disk
When erasing a directory, all files in this directory will be erased too.

13.2. Management of the configuration files

The configuration file management page is linked to the  key. There name bear the "cnf" extension.

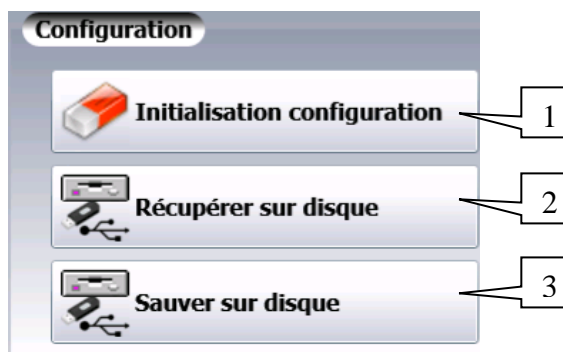

- 1- **Reset**: sets up the appliance in standard configuration
- 2- **Load from disk**: loads a configuration from a file in the internal flash disk or an USB stick
- 3- **Save to disk**: saves a configuration into a file in the internal flash disk or an USB stick

13.2.1. Save set-up files

Press « **Save to disk** »

You can type the name of the file with the alphanumerical keyboard displayed on screen.



Advice: Do not save files to the root of the disk; create directories for a more efficient management.

13.2.2. Load set-up files

Press « **Load from disk** »

Select the directory and then the file to load, and click « **Load** ».





Attention: you will lose the pending configuration.

13.2.3. Save data acquisitions

There are 2 ways to save data acquisitions into the appliance:

- in **Manual** mode after a data acquisition
- in **Real Time** during a data acquisition.

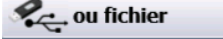
→ Manual:

Available under every mode; you can access it from the  function after stopping the sweep and pressing . The following window pops up:

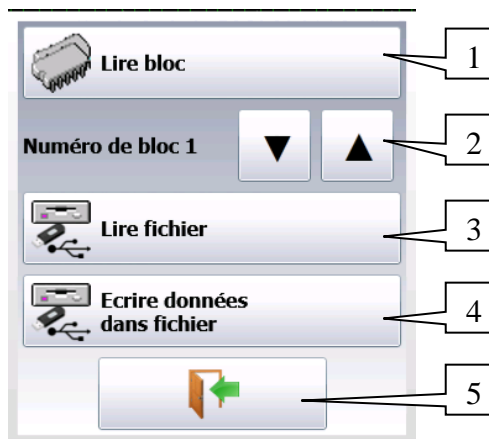

- 1- **Read block:** lire un bloc mémoire
- 2- **Selection of the block to read**
- 3- **Read a recorded file**
- 4- **Write data into a file:** Record the data displayed on screen into another file.
- 5- **Close the window**

→ Real time:

Available in **Direct**, **Memory** and **Template** modes after validation of « **Real Time Save** » in the triggers page:

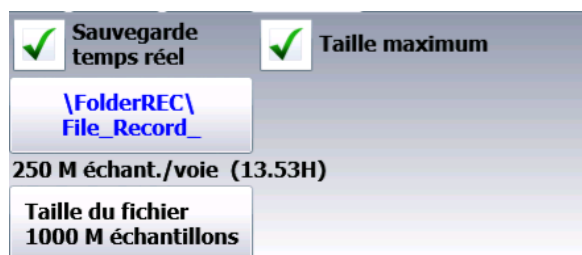

As soon as the record is launched, the appliance saves the samples into the file. The file closes when the data acquisition is done.



If the data acquisition is waiting for a start trigger, the appliance records into the file all points before this trigger. When the data acquisition stops, the file will include more points than the memory block that was used for the data acquisition.

In both cases – Manual or Real Time record – the date of the file is the date when the file was closed.

Name of the files: the name of each file is made of 12 characters plus one 4-cipher number. The appliance will automatically increase this number at each record.



Only the validated channels (i.e. in **ON** position; see chapter **Use**) will be recorded into the file.

Before writing into the file, a pop-up reminds you the saved channels and the number of points per channel.

The file is made of:

- a header, including the information later required to recover the file (the set-up of each channel, the sampling rate, etc.).
- the N samples (1 sample = 2 octets per channel).

13.2.4. Recovery of the data acquisition files

Press  from the main menu, then .

The following window pops up:



Select . The following window pops up:

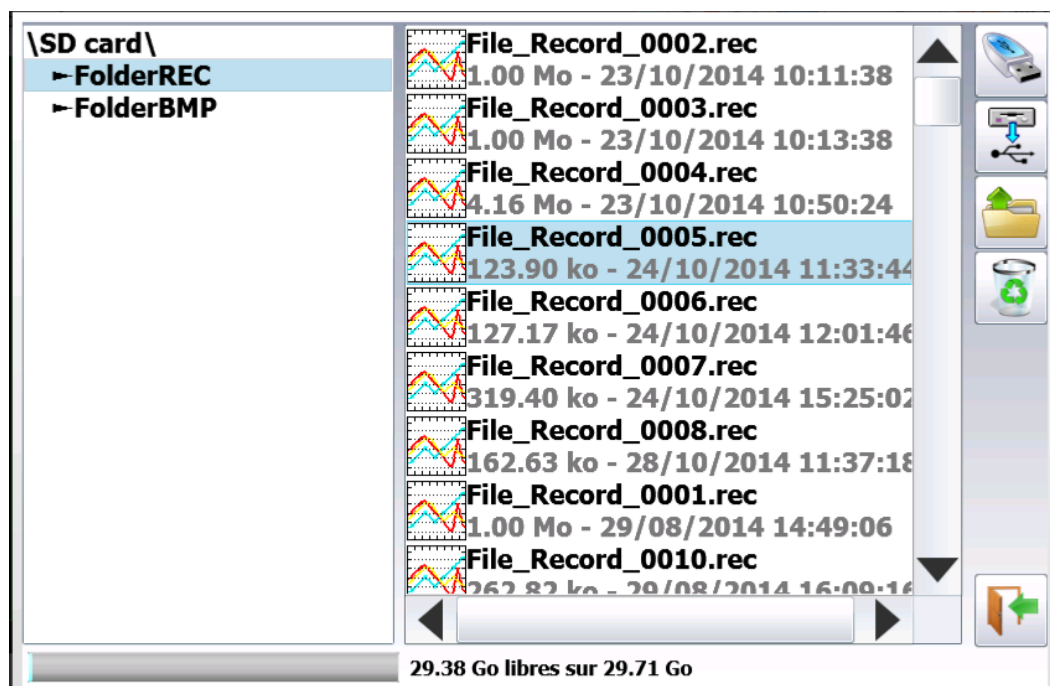

Select the place and the name of the file to load and display on screen, then press



13.3. Operating software

Data acquisition files may be transferred to a PC computer.

The SeframViewer software is provided on a CD-ROM with the appliance. It makes it possible to display the recorded files or convert them as xls or txt files.

It works under WINDOWS XP, 2000, Vista, Seven, 8 with Framework 2.0

- Transfer of files from the recorder to the PC:
 - USB peripheral
 - Thanks to the FTP protocol.

13.3.1. Transfer via FTP

➔ Using SeframPilot:

The ftp transfer is made directly by SeframPilot: if the IP address is for DAS30/50, validate with



➔ Using Windows Explorer:

You can create a favorite icon:

- Go to Tools → Connect to a network driver
- Click « Open a storage session or a network server »
- Under « Internet network address », type ftp:// and the IP address of the recorder.

You can give a name to this link that will always be active among « network favorites ».

You get a direct access to the directories of your recorder, which contain the data acquisition files: main directory on the internal flash disk of your appliance.

Once selected the directory where you record your data acquisitions, you can rename, move, copy and delete them.



- You cannot read a file in real time while recording it.
- You cannot delete a file while the recorder reads it.

Transfer your files to your computer to use them with the SeframViewer or FLEXPLO software.

13.3.2. Display under SeframViewer

Launch SeframViewer (or double-click on a file)

Open a.REC file.

You can select:

- the channels to display
- the display mode f(t) or xy
- the autocalibration of the channels.

Your data acquisition file shows up on screen.

SeframViewer functions are available.

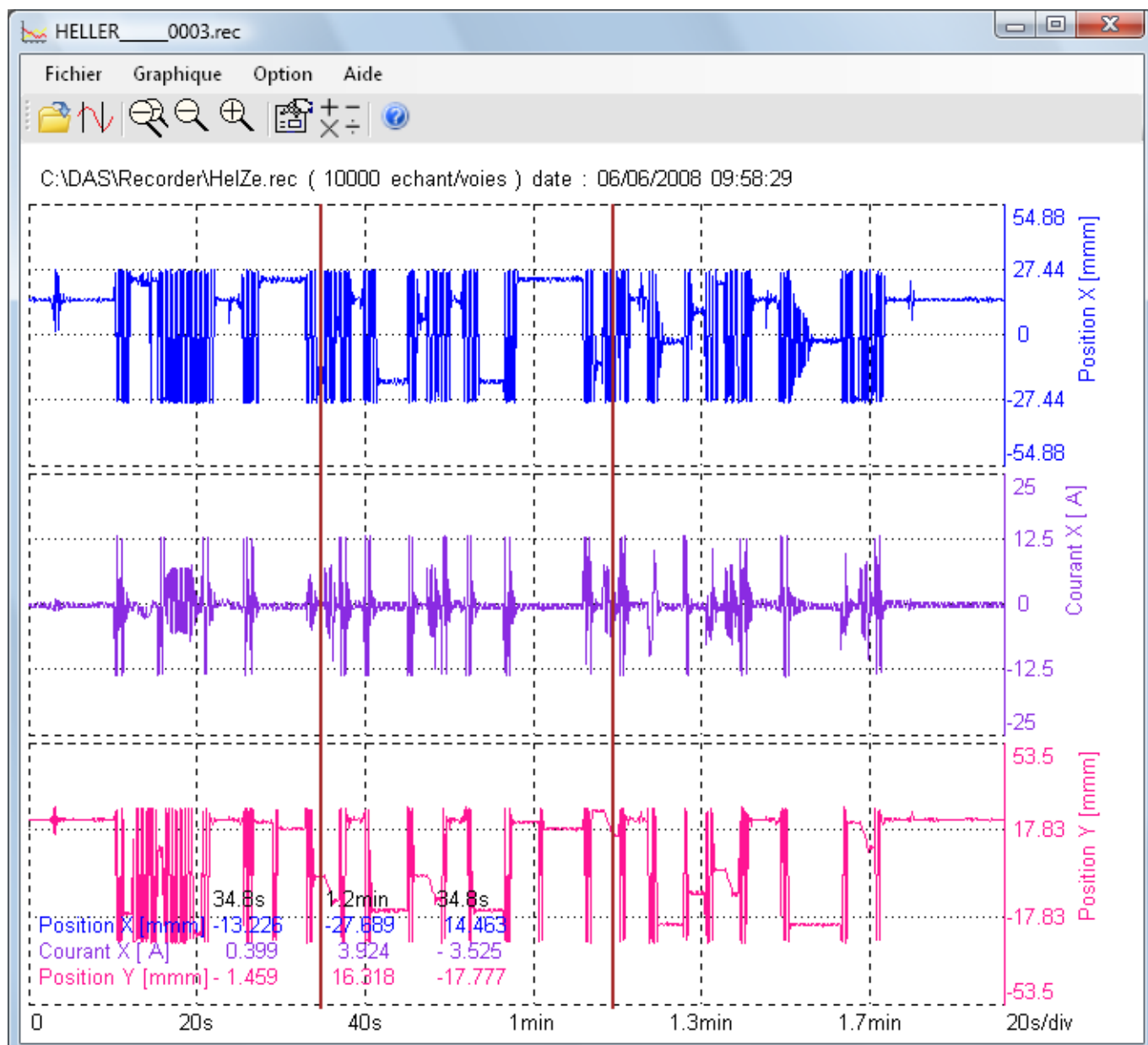

Refer to the user's manual included in the software to discover all functions of SeframViewer by clicking the last icon: « **Help** ».

You can also directly create a result file (text or Excel file) by launching the following line in the Windows® command mode: (see Menu, sub-menu Help Options)

Example:

C:\SeframViewer monfichier.rec /x : direct creation of an Excel file

C:\SeframViewer monfichier.rec /t : direct creation of a text file.

Excel® export directly launches Excel in the explorer.



13.3.3. Managing with SeframPilot

You can manage the recorder directly from SeframPilot. This software allows you to:

- Manage set-ups (creation and change set-up files)
- Start and stop records
- Load data blocks
- Load files thanks to Windows Explorer through FTP
- Launch SeframViewer
- Real time display of data in F(t) format

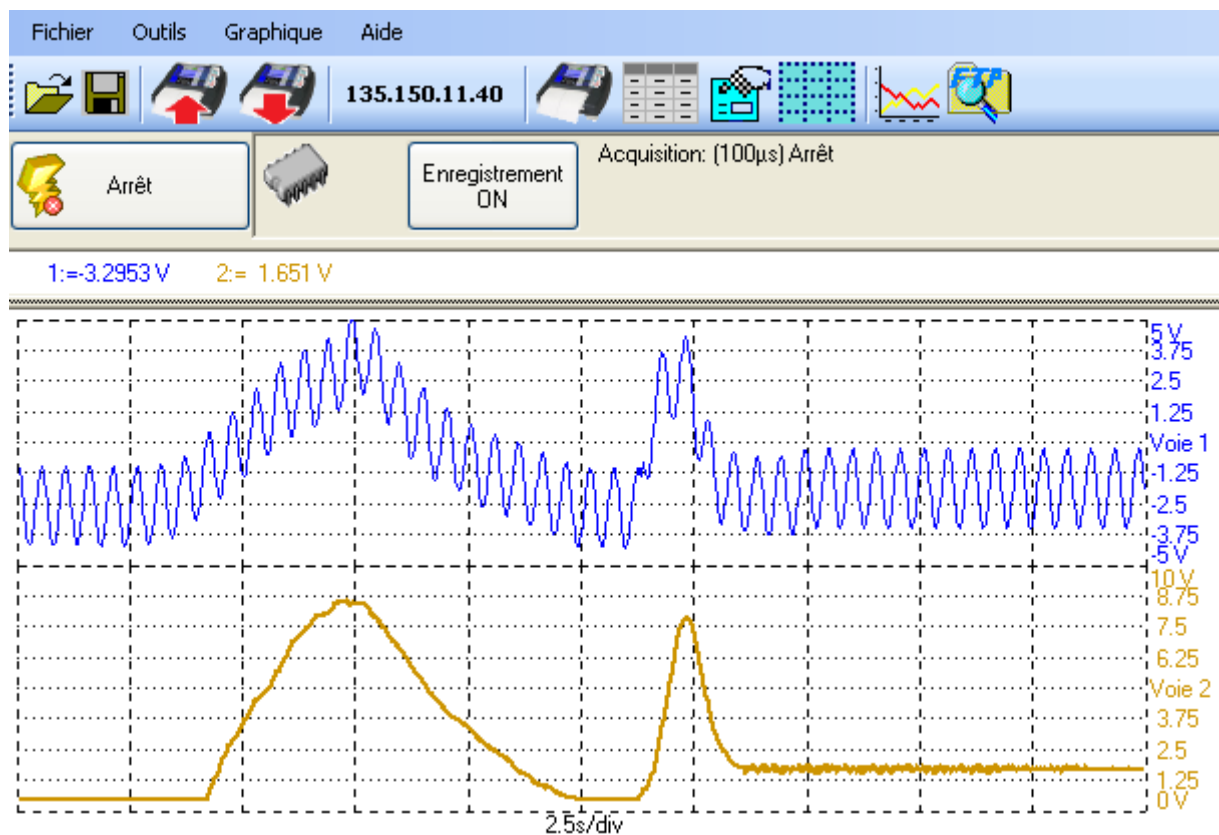

14. INPUTS / OUTPUTS

14.1. Additional Input/Output Connectors

The connector is at the rear (female SUB-D 25pin).

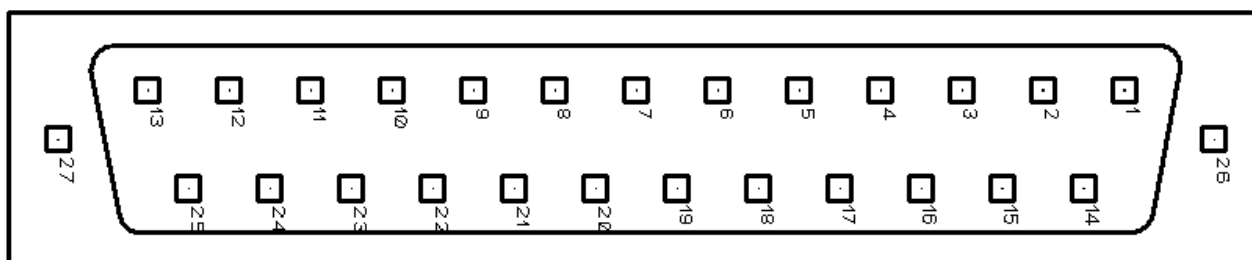

# pin	I/O	Name of the signals
13	I	Logic channel 1
25	I	Logic channel 2
12	I	Logic channel 3
24	I	Logic channel 4
11	I	Logic channel 5
23	I	Logic channel 6
10	I	Logic channel 7
22	I	Logic channel 8
9	I	Logic channel 9
21	I	Logic channel 10
8	I	Logic channel 11
20	I	Logic channel 12
7	I	Logic channel 13
19	I	Logic channel 14
6	I	Logic channel 15
18	I	Logic channel 16
5		Ground
17		Ground
4		Ground
16	O	9-15V 0.2A power
3		Ground
15		N.C
2		N.C
14	O	Alarm A
1	O	Alarm B

The power supply ground is the mechanical ground of the carter of the SUB-D25 connector.

14.2. Logic inputs

Non-connected inputs are according to the following circuit:

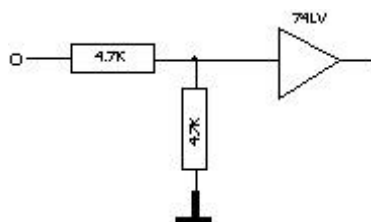

Non-connected inputs are 0V potential (level 0).

Number of logic channels: from 1 to 16.

TTL level: 3.3V (protected up to 24V)

To create a rising edge, you only have to place a connection between the power input and output of the connector.

Similarly, to create a falling edge, you only have to remove this connection.

You can also use an output signal TTL 3.3V.

14.2.1. Use

Plotting and display:

These channels are plotted on the right or left side of the paper according to the selected format.

They are displayed at the top or the bottom of the screen according to the selected position.

They are numbered from the right to the left.

Each channel is plotted between two dotted lines that show their limits.

The height of reticules is min. 2mm for the plot.

External clock:

You can use the logic channel 16 (see figure "connector") as a data acquisition clock for the sampling in memory or file mode. The data acquisition can then be made up to 500kHz.

Triggers:

You can use the logic channels to trigger the plotting and the data acquisitions (start and stop). (AND or OR mode)

See chapter « **Trigger** ».

14.3. Alarm outputs

Available contacts and outputs on the rear connector A and B.

All outputs are TTL 5V.

When the appliance is powered off, A and B outputs have a 5k Ω impedance.

14.3.1. Use

Signal for internal events to the outside toward the recorder (triggers on logic or analogic channels, status of the printing block...)

See chapter « Use ».

14.4. Power supply output

There is a power supply output restricted to 0.2A (see figure "connector").

The tension is the one of the 9-12V battery as a function of the charge and 15V is the charger is connected.

The ground of this power supply is the mechanical ground.

Thus, you can use this output to provide power to a sensor or an electronic circuit in order to manage the logic inputs.



The power supply may disappear in case of overload ($> 0.2A$).
In this case, you must turn off the appliance a few minutes before turning it on again.

14.5. Extension box input/output interface

The extension box input/output interface option (code 984405500) makes it possible to:

- Convert an alternating tension (example 230V 50Hz) into a logic signal 1
- Easy connection of the inputs of the 16 logic channels
- Insulation of the 16 logic inputs (250V= \sim between channels, 250V= \sim between channels and ground)
- Easy connection of the alarm outputs by a screw terminal
- Power supply of an external accessory with 3.3V, 5V or 12V by a screw terminal.

Connection of the logic channels according to the signal tension:

- 0 to 250V = \sim

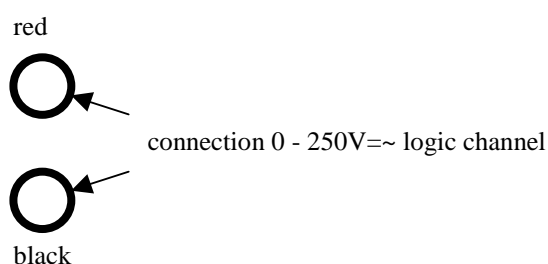

by insulated pin plug between red and black terminals

max. usable tension: 250V continuous or alternating

typical trip threshold (AC or DC): 48V

frequency: 45 to 440Hz

undetected low threshold (AC or DC): 0 to 10V

detected high threshold (AC or DC): 60V to 250V

insulation: 250V= \sim between channel and ground

- 0 to 48V = \sim

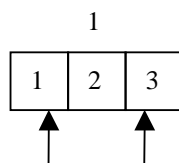

connection 0 - 48V logic channel

by a screw terminal between the points 1 and 3 of the screw terminal box

max. usable tension: 48V (AC or DC)

frequency: 45 to 440Hz

typical trip threshold (AC or DC): 9V

undetected low threshold (AC or DC): 0 to 2V

detected high threshold (AC or DC): 10V to 48V

insulation: 50V= \sim between channel and ground

- 0 to 10V= \sim

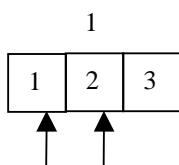

connection 0 - 10V logic channel 1

by a screw terminal between the points 1 and 2 of the screw terminal box
 max. usable tension: 10V continu ou alternatif
 frequency: 45 à 440Hz
 typical trip threshold (AC or DC): 2.2V
 undetected low threshold (AC or DC): 0 to 1V
 detected high threshold (AC or DC): 3V to 10V
 insulation: 50V= \sim between channel and ground

Response time:

To detect the alternating current, the signal of the logic channels is rectified and filtered.
 Typical delay for a rising signal: 10ms
 Typical delay for a falling signal: 50ms

Use:

Link the box to the input/output connector of the appliance with the 25-pin connector provided as an option.
 Connect the logic channels to record with respect of the maximum acceptable tensions.

Power supply / Alarms:

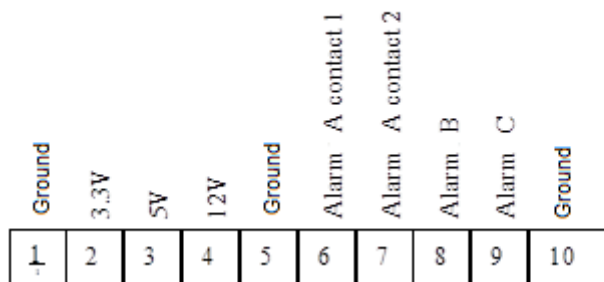

max current 3.3V: 200mA
 max current 5V: 200mA
 max current 12V: 200mA
 Alarm A contact 1 & 2: open contact in case of alarm, insulation 50V_{max} / ground
 Alarm B: logic output 0V / 5V not isolated
 Alarme C: logic output 0V / 5V not isolated

15. ETHERNET INTERFACE

15.1. Ethernet Interface

15.1.1.General

You can use the recorder remotely via its Ethernet interface with the TCP-IP protocol. Connect the recorder to your network with a straight-through cable onto the 10/100 BASE-T (RJ45) connector at the rear of the appliance.

You can use the recorder on an Ethernet network 10 Mbit/s or 100Mbit/s.

In case of a network with BNC cable, you must use an external hub to convert the BNC signal into RJ45 signal (use a straight-through cable).

If your PC has no network, you can also use a crossover cable directly between the PC and the recorder.

Crossover cable

Connector 1		Connector 2	
Pin	Signal	Pin	Signal
1	TX+	3	RX+
2	TX-	6	RX-
3	RX+	1	TX+
6	RX-	2	TX-

The recorder uses the TCP/IP protocol to dialog with the PC. Thus, you can give it an IP address with a subnet mask.

Ask your network administrator an IP address and a corresponding mask, then, when you have set

up the recorder with the  key, turn off and on the appliance, so that the changes are taken into account.

If you don't have any network administrator:

Check that the TCP/IP driver is correctly installed on your appliance.

Case of a PC under Win XP or other:

From Windows Explorer, go to "Work station", "Configuration panel", "network connection", and then go to the properties of the network card.

Check that the TCP/IP protocol has been installed, then check the IP address and the subnet mask.

You have to take great care and define an IP address and a subnet mask that are compatible with the ones of the remote computer.

The port that the recorder uses is **Port #23**.

For example, in I mode, you could have:

PC	IP=192.135.20.00	mask = 255.255.255.0
Recorder	IP=192.135.20.01	mask = 255.255.255.0

Refer to the definition of the classes of IP addresses.

Programming:

You can create your own software under Visual Basic, Visual C++, etc. by using, for example, the Winsock.dll driver by Microsoft.

Then, you only have to send the commands as per the following paragraphs to the recorder.

15.2. Programming language

15.2.1. Format of the reception messages



In all the following examples, the space character is pictured as a blank space.

Exchanges from a controller to the recorder are made as messages made of a chain of ASCII characters (and possibly of binary octets) with a message termination at the end.

Syntax of a receipt message

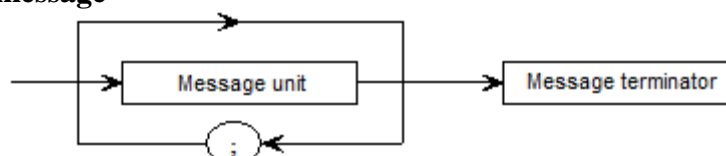

Message unit: if the message includes several message units, they are separated with a semicolon ";" and possibly preceded and/or followed by one or several "filling" characters in ASCII code (0 to 32, in decimal format except 10 and 13).

The message termination (TERM) for the Ethernet link is:

- LF: Line Feed (10 in decimal)

The message termination may be preceded with one or several "filling" characters under ASCII code (0 to 32, in decimal format except 10 and 13).

Example of messages made with 3 message units:

MESSAGE 1; MESSAGE 2 ; MESSAGE 3 TERM
CHANNEL 1; TYPE:VOLTAGE DC;;CALDEC ? TERM

Syntax of a message unit

A message unit (ex. :REAR:SETUP 1) is made of several fields:

- Header:

For the command messages (ex. **:REAR:SETUP 1**) or query messages (ex. **:REAR ?**), it is made of a chain of characters (simple header) or several chains separated by ":" (compound header).

A chain includes from 1 to 12 alphanumeric characters or "_" (code ASCII 95 in decimal format). Recommended chain length: 4 characters.

A header chain always starts with an alphabetic character. It may be preceded by a colon ":" (compound header) or end by a question mark "?" (query message).



Query messages must be followed by the termination.

- Header separator:

One or several ASCII characters (0 to 32, decimal except 10 and 13).

- One or several pieces of data:

(ex. :SPEED **1,MM_S**), alphanumeric, digital or compound of various characters or binary octets.

- Data separator:

A comma ",", possibly followed and/or preceded by one or several "filling" characters in ASCII code (0 to 32, decimal except 10 and 13).

Data:

There are several types of data:

- Alphanumeric data:

1 to 12-character words that can be alphabetic (upper case or lower case), digital or "_" (95d) coded under ASCII.

Words always start with an alphabetic character.

For example, for a non-digital parameter: S1M.

- Decimal digital data:

Made of a mantissa and possibly of an exponent, and shown as a chain of ASCII characters starting with a cipher or a sign (+ or -). They are of NR1 (integer), NR2 (decimal) or NR3 type (with exponent) or of a combination of these three types.

- Text:

Any chain of ASCII 7-bit characters between brackets (") or apostrophes (').

ex. "Channel 1"

15.2.2. Formats of emission messages

Exchanges from a recorder to a controller to the recorder are made as messages made of a chain of ASCII characters (and possibly of binary octets) with a message termination at the end.

The format of emission messages is identical to the reception messages, although with a more rigid structure.

The syntax of an emission message is: **Message unit + message termination.**

Message unit:

If the message includes several message units, they shall be separated by a semicolon ";".

Message termination:

- LF: Line Feed (10 in decimal format)

Syntax of a message unit:

A message unit (ex. TYP:THE J,COMP) is made of several fields:

- *One header:*

(ex. **TYP:THE**) made of only one (simple header) or several (compounds header) chains of 1 to 12 alphanumeric characters (upper scale only or digital or "_" (code ASCII 95 in decimal format).

A header chain always starts with an alphabetic character.

In a compound header, chains of characters are separated by ":" (ex. TYP:THE).

- *Header separator:*

"space" (32d) only.

- *One or several pieces of data:*

(ex. **J,COMP**) alphanumeric, digital or compounds of any characters or binary octets.

- *Data separator:*

Comma ",",

Data:

There are several types of data:

- *Alphanumeric data:*

1 to 12-character words that can be alphabetic (upper case only), digital or "_" (95d) coded under ASCII (example: **J**).

- *Decimal digital data:*

Made of a chain of ASCII characters starting with a cipher or a sign (+ or -). They are of NR1 (integer), NR2 (decimal) or NR3 type (with exponent). For example, for a digital character: -25.02.

- *Text data:*

Any chain of ASCII 7-bit characters between brackets (") or apostrophes (').

Example : "A".

- *Any chain ASCII characters ends with the message termination.*

15.3. Standard instructions

All these instructions start with an asterisk "*".

***IDN ?** REQUEST TO IDENTIFY AN APPLIANCE

answer by the appliance: 4 pieces of data separated by '':

- the trademark of the appliance
- the name of the appliance followed by _nn where nn is the number of inputs of the recorder
- the serial number of the appliance (0 if unknown)
- the software version number as x.xx x

***OPT ?** REQUEST TO IDENTIFY OPTIONS OF AN APPLIANCE

answer by the appliance: n pieces of data separated by ';':

- number of cards
- number of channels per card

***RST** RESET OF AN APPLIANCE

action: set-up of a recorder in a fixed configuration (tension inputs, 10V caliber, centered on 0V...)

REM** PENDING PROGRAMMING PART (REMOTE) (facultative)LOC** RETURN TO LOCAL MODE***CLS** ERASING THE STATUS LOGS

action: the appliance resets the status logs.

***ESE** VALIDATION OF THE STANDARD EVENT BITS OF AN APPLIANCE

*ESE is followed by a number between 0 and 255

action: changes the log of validation of the standard events and updates the ESB bit in the status log of service request (see following paragraph).

***ESE ?** INTERROGATION OF THE CONTENT OF THE VALIDATION LOG OF THE STANDARD EVENTS OF AN APPLIANCE

answer by the appliance: NR1 number between 0 and 255 (see following paragraph).

***ESR ?** INTERROGATION OF THE CONTENT OF THE STATUS LOG OF THE STANDARD EVENTS OF AN APPLIANCE

answer by the appliance: NR1 number between 0 and 255.

All events are erased and the log is reset to zero (see following paragraph).

***SRE** VALIDATION OF THE SERVICE REQUESTS OF AN APPLIANCE

*SRE is followed by a number between 0 and 63 or between 128 and 191.

action: the appliance changes the validation log of the service request (see following paragraph).

***SRE ?** INTERROGATION OF THE VALIDATION LOG OF THE SERVICE REQUESTS OF AN APPLIANCE

answer by the appliance: NR1 number between 0 and 63 or between 128 and 191 (see following paragraph).

***STB ?** READING OF THE SERVICE REQUEST LOG OF AN APPLIANCE

answer by the appliance: NR1 number between 0 and 255: status word with bit 6 MSS (Master Summary Statut) (see following paragraph)

15.4. Indication of the status of the appliance

15.4.1. Structure of the status data

Here is the pattern of the structure of status data: they keep you informed about the changes of status in the appliance (reconnection, printing start...).

Overview of the structures of status data of the recorder:

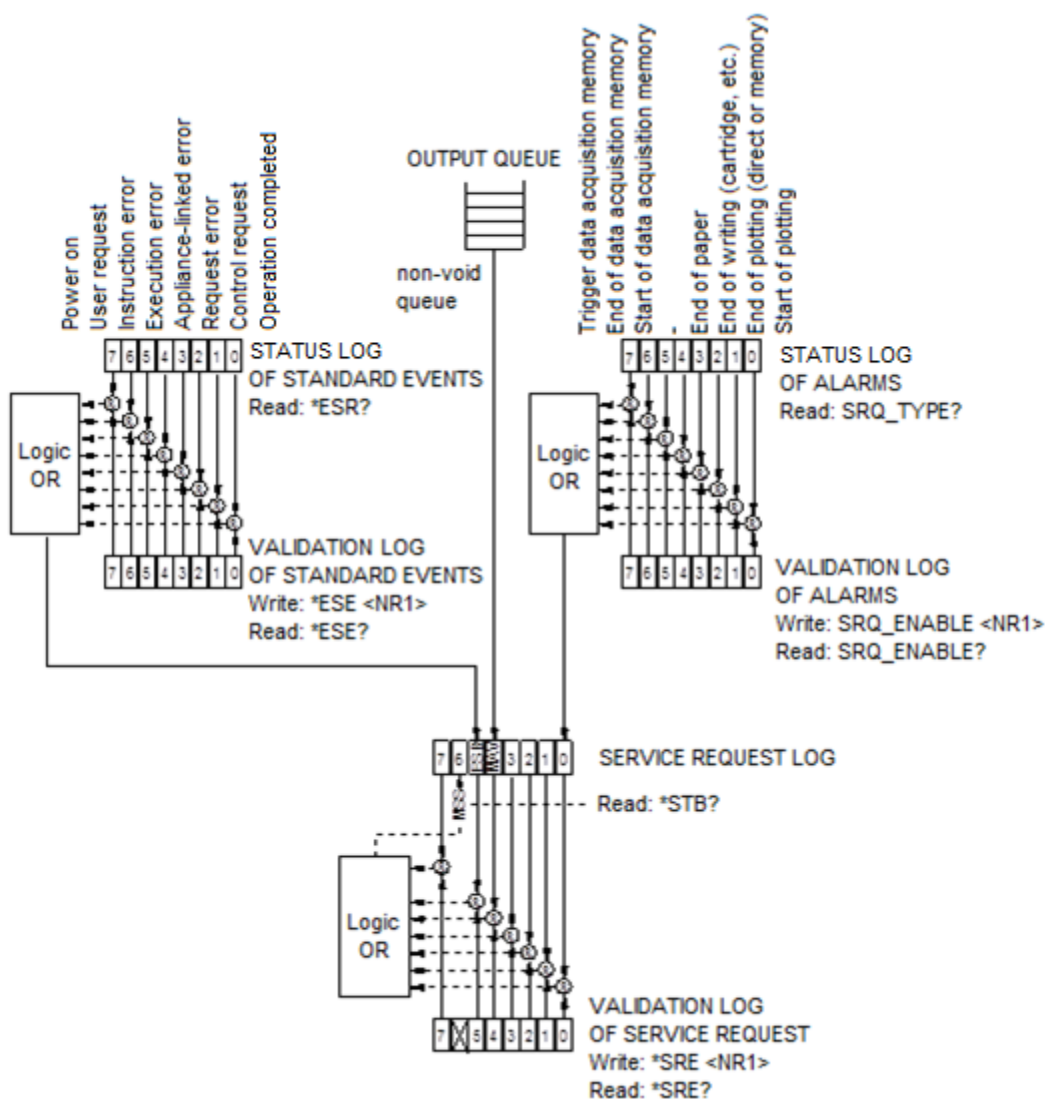

4 logs are used:

- the service request log (STB) associated with its validation log.
- the standard event log (ESR) associated with its validation log.

The bits #0, 1, 2 and 7 of the STB log are available for use as sum-up messages specific to the appliance. Each of these bits can be associated to a structure of data with a defined pattern, which will manage the events in the appliance that may lead to a service request.

The user may set up the recorder, so that it activates the bit #6 of the service request log in case of one or several specific events.

Status of these logs at power-up:

The content of the STB, ESR and alarm logs is systematically reset at power-up (except the bit #7 of the ESR that specifies a power-up).

15.4.2. Service request logs

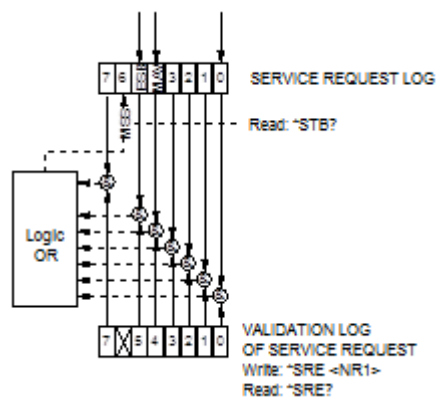

Status log:

It includes the status word of the appliance.

You can read this status word thanks to the request with the `"*STB?"` instruction. In this case, the bit #6 is MSS (Master Summary Status) that results from the logic operations as pictured in the figure below.

Indeed, MSS is 1 when at least one of the other bits is 1 both in the status log and in the validation log.

Composition of the STB log:

The bit #6 (value 64) contains the sum-up message "MSS" (reading with `"*STB?"`).

The service request takes place in the following cases:

- one bit of the status log of service request switches from 0 to 1, while the corresponding bit in its validation log is 1, and vice versa
- the bit #5 of the validation log of service request is 1; a standard event happens in the following conditions:
 - one bit of the status log of standard events switches from 0 to 1, while the corresponding bit in its validation log is 1
 - one bit of the validation log of standard events switches from 0 to 1, while the corresponding bit of its status log is 1
- the bit #0 of the validation log of service request is 1; a standard event happens in the following conditions:
 - a bit of the status log of alarms switches from 0 to 1, while the corresponding bit in its validation log is 1
 - a bit of the validation log of alarms switches from 0 to 1, while the corresponding bit of its status log is 1.

The bit #5 (ESB: Event Status Bit, value 32) contains the sum-up message of the status log of standard events (see the detail of these bits in the description of this log). Its status specifies whether one or several authorized events have happened in the status log of standard events since its latest reset (an event is authorized if the corresponding bit in the validation log of events is 1).

The bit #4 (MAV: Message AVailable, value 16) contains the sum-up message of the output queue. Its status specifies whether a message or data from the appliance are ready for emission via the interface (ex: answer to a query instruction).

The bits #7, 3, 2, 1 and 0 are used to receive sum-up messages as defined by the appliance. In the case of the recorder, the bit #0 is used while the bits #1, 2, 3, 7 always remain 0.

The bit #0 contains the sum-up message of the status log of alarms (see the detail of these bits in the description of this log). Its status specifies whether one or several authorized events have happened in the status log of alarms since its latest reset.

Validation log:

The status word is associated to a validation log that makes it possible to manage the service request by allowing it only for some specific cases.

When a bit is 1, it allows that the status 1 of the bit of same rank in the status log (STB) leads to the activation of the bit #6 of the same log.

Writing the validation octet is made with the command *SRE<NRF>, where <NRF> is the sum of the binary values of the bits 0 to 5 and 7. *Reading* the validation octet is made with the instruction *SRE?. The answer is sent back under decimal format (NR1).

15.4.3. Log of standard events

Refer to the overview of the structures of status data.

The structure of the logs of standard events is appended to the bit #5 of the log of service requests.

Status log:

This log contains some specific standard messages, whose meaning is exposed hereafter.

You can read its content with the command *ESR?

Reading the log erases it.

The bits of the log of status of events are appended to specific events:

* bit #7: POWER UP (value 128)

It shows that the appliance has been powered up

* bit #6: REQUEST FOR USE (value 64)

Not used. Positioned to 0

* bit #5: INSTRUCTION ERROR (value 32)

This bit shows that an unknown or wrong instruction has been sent to the recorder

* bit #4: EXECUTION ERROR (value 16)

Not used. Positioned to 0

* bit #3: APPLIANCE-LINKED ERROR (value 8)

Not used. Positioned to 0

* bit #2: REQUEST ERROR (value 4)

This bit shows that the output queue is full and that the data is or may be lost

* bit #1: CONTROL REQUEST (value 2)

Not used. Positioned to 0

* bit #0: OPERATION COMPLETED (value 0)

Not used. Positioned to 0

An event is authorized if the corresponding bit in the validation log of events is 1.

Validation log:

It manages the status log of standard events:

When a bit of this log is 1, it authorizes that the status 1 of the bit of same rank in the status log of standard events leads to the switch to 1 of the **bit #5** in the status log of service requests (STB).

You can write in this log with the command `*ESE<NRF>` where `<NRF>` is the sum of the binary values of the validation log.

You can read its content with the command `"*ESE?"`

15.4.4. Log of alarms

Refer to the overview of the structures of status data.

The structure of the log of alarms is appended to the bit #0 of the log of service requests.

Log of status:

This log contains some messages specific to the recorder, whose meaning is exposed hereafter.

You can read its content with the command `SRQ_TYPE?`

Reading the log erases it.

The bits of the status log of alarms are appended to specific events:

- bit #7: TRIGGER DATA ACQUISITION MEMORY (value 128)

This bit shows that the trigger condition of a data acquisition into memory has been achieved.

- bit #6: END OF DATA ACQUISITION MEMORY (value 64)

This bit shows that a data acquisition into memory has been achieved.

- bit #5: START OF DATA ACQUISITION MEMORY (value 32)

This bit shows that a data acquisition into memory has been launched.

- bit #4: Not used (value 16)

- bit #3: END OF PAPER (value 8)

This bit shows that there is no more paper in the printer.

- bit #2: END OF WRITING (value 4)

This bit shows that a text writing is achieved: cartridge, text programmed with the instruction `WRite` (see dictionary of programming)...

- bit #1: END OF PLOTTING (value 2)

This bit shows that a printing is achieved.

- bit #0: START OF PRINTING (value 1)

This bit shows that a printing has started.

An event is authorized is the corresponding bit in the validation log of events is 1.

Validation log:

It manages the status log of alarms:

When a bit of this log is 1, it authorizes that the status 1 of the bit of same rank in the status log of alarms leads to the switch to 1 of the **bit #0** of the status log of service requests (STB).

You can write into this log with the command `*SRQ_ENABLE <NRF>` where `<NRF>` is the sum of the binary values of the validation log.

You can read the log with `"SRQ_ENABLE?"`

15.4.5. Use of the status data structure

Before use, it is advisable to send the instruction `*CLS` to the recorder to reset the status logs.

The user must first set which events to detect by authorizing them in the validation log:

- with the instruction `"SRQ_ENABLE n"` for events in connection with the alarm logs
- with the instruction `"*ESE n"` for events in connection with the logs of standard events
- with the instruction `"*SRE n"` for events in connection with the log of service requests.

Example:

Programming a request of service for: a start or an end of the paper print, an instruction error, the presence of data at the output of the recorder, with the instructions:

SRQ_ENABLE 3 (Bit #0 and 1 to 1)
*ESE 32 (Bit #5 to 1)
*SRE 49 (Bit #0, 4 and 5 to 1)

The controller should regularly read the log of service requests with the instruction "*STB?".

Switching of bit #6 (MSS) to 1 shows that an authorized event happened.

Reading the status word makes it possible to discover the type of event that happened. In the case of a standard or specific event, you have to read the associated status log with the instructions "*ESR?" or "SRQ_TYPE?" to precisely identify the event.

A standard event appeared. The instruction "*ESR?" is sent:

Answer by the recorder: 160 (bit #7 and 5 to 1)

Two events are shown (power up and instruction error) but the request of service has been caused by the instruction error only (the only authorized event in the validation log).

15.5. Dictionary of programming

In the following table, it is not compulsory to send the lower case characters of the headers and parameters.

As a rule, digital parameters are integers (NR1); parameters specified "decimal" may be NR1, NR2 or NR3.

15.5.1. Configuration

ALArm	P1 Definition of the alarm to change P1=A,B	ALARM:VAL A,TR;TR:CH A1,S1,EDGE the trigger is then set by the command TRig: (see chapter 16.5.8)
ALArm:DEF	P1 P2=NO, Trigger, RECtr or ERRor	
ALArm ?	Returns the alarms	
DATE	P1,P2,P3 changes the current date P1 = day (from 1 to 31) P2 = month (from 1 to 12) P3 = year (from 0 to 99)	DAT 11,12,10 December 11th 2010
DATE ?	Returns the date	
HOUrs	P1,P2,P3 Changes the current time P1 = hour (from 0 to 23) P2 = minute (from 0 to 59) P3 = second (from 0 to 59)	HOURS 10,6,0 10 hours and 6 minutes
HOUrs ?	Returns the time	
READSEtup	Recovery of the current set-up under binary format The appliance returns: 4 octets giving the number of octets and 2 giving the checksum to send, then the configuration file N configuration octets	
SENDEtup	Send a set-up under binary format YOU send: 4 octets giving the total length of the file and 2 octets giving the checksum of the set-up	The length of the file is 6600 octets
KEYBLock	P1 Locks the keyboard (ON or OFF)	

15.5.2. Parameters of the channels

HEADER	PARAMETERS	EXAMPLES
CHAnnel	P1 Allows you to set the CHANNEL input you can change with the commands P1 = selection of the input A1, A2, etc.	CHAN B3 We chose to change the channel 3 of card B
CHAnnel ?	Returns the number of the selected input and its value.	
VALID	P1,P2 Definition of the authorization status of each channel P1 = ALL for all channels, or A1, A2 etc. for each channel LOG for the logic channels P2 = ON or OFF	VALID ALL,OFF; VALID A1 ON; VALID LOG,ON Only the channel A1 and logic channels are authorized
VALID ?	Returns the validity of all inputs	
NAME	P1 Allows to change the name of the CHANNEL input P1 = name (26 char. Max.) between two ' or "	CHAN B3; NAM 'four1'
NAME ?	Returns the name of the channel	
TYPe:VOLTage	P1 Change of the channel to TENSION P1= DC , RMS DVDT SVDT	TYPE:THERM K,COMP Use of a thermocouple K with compensation
TYPe:SHUNT	P1,P2 Change of the channel to SHUNT P1 = DC or RMS P2 = S1M,S10M,S01,S1,S10,S50 (for 1mOhm ... 50 Ohm)	
TYPe:FREQ	Change of the channel to FREQUENCYCOUNTER	
TYPe:PT100 ou PT1000	P1,P2 Change of the type of channel to PT100 P1= W2,W3,W4 for 2 wires, 3 wires or 4 wires P2= Value of the resistance (if W2)	
TYPe:THErmo	P1,P2 Change of the type of channel to Thermocouple P1= Thermocouple = J,K,T,S,B,E,N,W	
TYPe:COUNTer	P1 Change of the type of channel to COUNTER P1= decision threshold (in volt)	TYP:COUNT 1.4 the command resets the counter
TYPe ?	Returns the type of channel	
UNIt	P1 Temperature unit in thermocouple and PT100 P1: CEL,FAR,KEL	UNIT CEL Unit Celsius
UNIt ?	Returns the temperature unit of the channel	

HEADER	PARAMETERS	EXAMPLES
FILter	P1 Definition of the filter of the selected channel from the CHANNEL command P1 = WOUT,F10kHz,F1kHz,F100Hz,F10Hz, F1Hz,F10S,F100S or F1000S	FILTER 10Hz
FILter ?	Returns the filter of the selected input	
RANge	P1,P2,P3 Changes the caliber and the center of the input :CHAN P1 = Caliber in ISO units (Volts or °C) in real time P2 = Center in ISO units in real time P3 = Position in percentage	RANGE 12,3,0 caliber = 12 Volts centered around 3 Volts
RANge ?	Returns the caliber and the center of the selected input	
THREshold	P1,P2,P3 Definition of the thresholds P1 = S1 or S2 P2 = ON or OFF (validation of the plot) P3 = Value of the threshold	:THRES S1,ON,10 threshold S1 = 10 Volts
THREshold ?	Returns the values of the 2 thresholds	

Return of the instant values:

EN-TETE	PARAMETRES	EXEMPLES
RDC ?	Returns the values of all channels and of the logic channels or of the parameters in network analysis	

15.5.3. Functions of the channels and between channels

HEADER	PARAMETERS	EXAMPLES
FUNCMATH	P1 Allows the selection of a mathematical function for the CHANNEL input P1 = Type of function : NONE, UNIT, AX, ABSX, SQRX, SQROOTX, LOGX, EXPX,AINVX,ADVDT,AINTV (none, change of unit, ax+b, a x +b, ax ² +b, ...)	CHAN 2; FUNCTION LOGX; The channel 2 = aLog(x)+b
FUNCMATH ?	Returns the function of the CHANNEL function	
COEFF	P1,P2 Definition of the coefficients of the function P1 = A, B, C or X1, X2, Y1, Y2	:COEF A,2;COEF B,0 A = 2 B = 0
COEFF ?	Returns the values of the coefficients of the function of the CHANNEL input	
UNITFunction	P1 Definition of the unit of the function P1 = name of the unit (max. 6 characters) between two " or ' .	UNITF 'DB'
UNITFunction ?	Returns the name of the unit of the function	
FUNCXY	P1,P2,P3 Additional function between channels P1 = Number of the channel 1 (from A1 to FF) P2 = Operateur PLUS,MINUS,MULT,DIV P3 = Number of the channe 1 (from A1 to FF)	CHAN FB;FUNCXY A1,PLUS,A2
FUNCXY ?	Returns the function	
RDUnt	P1 Selection of the measurement unit: P1: ISO unit of the channels NORM: standard unit between 0 and 10000	RDU ISO;ONOFF ALL,OFF;ONOFF A1,ON;ONOFF A3,ON;RDU ISO;DRC ?
FUNCTION	P1 Validity of the functions in general P1 = ON or OFF	
FUNCTION ?	Returns the validity of the functions	

15.5.4. Paper

HEADER	PARAMETERS	EXAMPLES
DIRECTPLOT	P1 Set-up of the transcription mode on paper in direct mode P1 = FT, TEXTe	DIRECTPLOT FT
DIRECTPLOT ?	Returns the paper mode	
SPEEd	P1,P2 Definition of the paper scroll speed P1 = speed value: 1,2,5,10,20 for P2 = MM_H or MM_M, 1,2,5,10,20,25,50,100,200 for P2 = MM_S P2 = units MM_S (mm/second) MM_M (mm/minute) MM_H (mm/hour)	SPEED 10,MM_S Speed 10 mm/s
SPEEd ?	Returns the status of the command SPEED or SPEED:EXT	
TEXTSpeed	P1,P2 Set-up of the paper period text mode texte P1 varies from 1 to 500 P2 is Sec or Min or HOurs	TEXTSPEED 2,SEC
TEXTSpeed ?	Returns the period in text mode	
GRATicule	P1,P2 Set-up of the reticule on the paper P1=WOUT,G5,G10 or DIV defines the type of reticule P2=Fine or Coarse	GRAT G5,C
GRATicule ?	Returns the reticule	
CHART:TITLE	P1 Set-up of the title of the acquisition P1 = message between apostrophes	CHART:TITLE "OVEN 12"
CHART:TITLE ?	Returns the title	
CHART:DATE	P1 Set-up of the type of date on the paper P1 = ABSolue or RELative	CHART:DAT ABS
CHART:DATE ?	Returns the command	
CHART:BOUUndary P1	P1 Sets up if writing the boundaries at the end of the plot P1 = WITH or WOUT	CHART:BOU WITH Writing the boundaries
CHART:BOUUndary ?	Returns the command	
ANNote	P1,P2 Set-up of the annotation mode P1 = WOUT, START, ALarm or LENGth P2 is worth the number of alarm (from 1 to 3) or the length of paper	ANNOT LEN,20 Annotation every 20cm
ANNote ?	Returns the command	
ANNote:TYpe	P1,P2,P3 Writing the names of the channels P1 = NONAME or NAME writing the names of the channels P2 =NONUMber, NUMber writing the names of the channels P3= NO, VALue, RANge, SCAle MINmax Set-up of the type of annotation to write	ANNOT:TYpe NAME, NUM, VALUE
ANNote:TYpe ?	Returns the command	

15.5.5. Triggerings

EN-TETE	PARAMETRES	EXEMPLES
START:MANual	Manual trigger (start or stop)	START:MANUAL
START:TRIG	Trigger on a combination of thresholds (see chapter 8.3)	start:trig::trig:chan A1,S1,POS
START:WAIt	P1,P2,P3 Trigger on a waiting time P1 = number of hours waiting (0 to 23) P2,P3 = minutes, seconds (0 to 59)	START:WAIT 0,2,10 waiting 2min 10sec
START:DATE	P1,P2,P3,P4,P5,P6 Trigger at a date P1 = day (from 1 to 31) P2 = month (from 1 to 12) P3 = year (from 0 to 99) P4 = hour (frm 0 to 23) P5,P6 = minute, second (from 0 to 59)	SEQ START;SEQ:DATE 3,10,06,15,30,10 starting on 3/10/06 at 15:30:10
START:AUTO	Automatic trigger (except in DIRECT mode)	
START ?	Returns the start command	
STOP:MANual	Manual stop (direct mode)	
STOP:TRIG	Trigger on a combination of thresholds (see chapter 8.3)	
STOP:WAIt	P1,P2,P3 Trigger on a waiting time (see START:WAIT) only in DIRECT mode	
STOP:DATE	P1,P2,P3,P4,P5,P6 Trigger at a date only in DIRECT mode	
STOP:LENGth	P1 End of trigger at a given length of plot (only in DIRECT mode) P1 = length of plot x 10cm	
STOP:AUTO	Automatic stop (memory or file mode)	
STOP ?	Returns the command of end of acquisition	

15.5.6.Triggers

TRIG:LOG P1	P1,P2 Selection of trigger on logic channels P1 = sets the 16 values of the triggers; add a message delimiter (brackets) P2 = AND or OR	TRIG:LOG "XXXXXXXXXXXXXXXXX1", trigger on logic channel VL1
TRIG:CHan P1,P2,P3	P1 = Number of the channel (A1,A2, etc.) P2 = Threshold (S1 or S2) P3 = POS or NEG for rising edge or falling edge	TR:CH A1,S1,EDGE P Trigger on rising edge of channel A1 (threshold 1)
TRIG:COm P1	Selection of the type of complex trigger P1 = OR, AND or DELta means: one of the thresholds (OR) all thresholds (AND) slope (DELta)	TRIG:CO DEL;CO:DEL 2,S;RESET; ADD A1,S1,POS; ADD A2,S1,NEG 2 thresholds (S1 on A1 and S1 on A2)
TRIG:COm:DELta P1,P2	Selection of the slope P1 = value (from 1 to 500) P2 = Sec or MIN or HOURS	
TRIG:COm:REset	ON removes all channels	
TRIG:COm:ADD P1,P2,P3	Add a threshold to the trigger P1 = Number of channel (A1, A2 etc.) P2 = Threshold (S1 or S2) P3 = POS or NEG for rising edge or falling edge	
TRIG ?	Returns the value of the selected trigger	



The programmed trigger depends on the latest sent command (alarm, trigger start, stop, etc.).

15.5.7. Memory mode

HEADER	PARAMETERS	EXAMPLES
MEMSpeed	P1,P2 Set-up of the sampling period P1 = Period (from 1 to 500) P2 = MICro,Mili,Sec,Min,HOur is the unit	MEMSPEED 10,MICRO 10 µsec period
MEMSpeed:EXT	Use of an external clock	
MEMSpeed ?	Returns the data acquisition speed	
MEMBloc	P1 Set-up of the number of blocks P1 = 1,2,4,8,16...128	MEMBLOC 4 4 blocks
MEMBloc ?	Returns the number of blocks and the validation of each block	:MEMBLOC 4,2 : 4 blocks, incl. 2 valid ones
POSTrig	P1,P2 Set-up of the triggering position in the data acquisition P1 = varies from -100 to +100 in % P2 = ON or OFF : inhibition of the trigger during the pre-trigger	:STOP:AUTO;POSTRIG 0 Acquisition after triggering
POSTrig ?	Returns the position of the trigger	
MEM:CONT	P1,P2 Set-up of the aftermath P1 = PLOt ,NOPlot P2 = File ,NOFile : save to a file	
MEM:CONT ?		
FILE:NAME	P1,P2 Name of the save file P1 = BINary, TEXTe file format P2 = name of the file (12 characters max.)	:FILE:NAME BIN,"FileO";LENG
FILE:NAME ?		
FILE:LENGth	P1,P2 Limit of the number of samples P1 = from 0 to 1000 (0: no limit) P2 = KSample or Msample	
FILE:LENGth ?	Returns the limit to the length of the file	

15.5.8. Relaunchs, real time save

HEADER	PARAMETERS	EXAMPLES
REARm	P1 définition du réarmement manuel P1 = SINGle, AUTo, SETup	REARm SINGLE
REARm:SETup	P1 Number of the set-up to change P1 = 1 to 15	REARM SETUP; REAR:SETUP 2 Go to configuration 2
REARm ?	Returns the type of relaunch	
SAVE	P1 Real time recording P1 = NO, DISK or MEMORy NO : no record DISK : record to HD or USBKey MEMORy (direct mode only)	SAVE DISK
SAVE ?		
SAVE:MEM	P1,P2 Set-up of the trigger for saving to memory in direct mode P1 = DIRect, TRIG or MANual P2 = CONt,NOCont relaunch	SAVE MEM;SAVE:MEM TRIG,NOc::TRIG:CHAN A2,S1,POS

15.5.9. Launching plots and data acquisitions

HEADER	PARAMETERS	EXAMPLES
RECOrd	P1 Start or stop of the plot (or of the data acquisition into memory) P1= ON : Start OFF : Stop TRIG : forcing the trigger TRIGREC : forcing the mix data acquisition trigger	RECORD ON In direct mode, the plot will be effective when the start condition is achieved; you may force the start trigger with RECORD TRIG, and the stop trigger with RECORD OFF.
RECOrd ?	Returns the command status and the percentage of data acquisition into memory	
WRItE	P1 Printing a message on paper (for appliances with a printer) Allows you to write an annotation while recording to disk P1 = message (max. 50 characters) between brackets (") or apostrophes (')	WRITE 'RECORDER'
LINE	Draws a vertical line	
TEXT	P1,P2 Writing an horizontal text (max. 50 characters) P1 = position between 0 and 252mm	TEXT 252,"high position"

15.5.10. Diagrams

GRID	P1,P2 Set-up of the diagrams P1 = Number of the diagram P2 = SEPLOGON or SEPLOGOFF : separate logic channels	GRID:LOG 50,5,UP;;GRID 2,SEPLOGON The logic channels are at the top and are 50mm tall on 2 100mm screens
GRID ?	Returns the set-up of all diagrams	
GRID:LOG	P1,P2,P3 Set-up of the diagrams for logic channels P1 = Number of logic channels P2 = Height of the logic channels P3 = UP or DOWN : position of the logic channels	
GRID:LOG ?	Returns the set-up of all diagrams	
GRID:LENGth	P1,P2,P3 Set-up of each diagram P1 = number of the diagram P2 = min value (0 to max); max = 250 or 200 according to the appliance P3 = valeur max (0 to max)	GRID:LENG 1,0,100 Diagram 1 from 0 to 100mm 1
GRID:LENGth ?	Returns the set-up of all diagrams	
GRID:CHAnnel	P1,P2,P3 Set-up of the position of a channel P1 = Number of the channel P2 = Number of the diagram: from 1 to max P3 = Thickness of the line: 1 to 8	GRID:CHA A4,3,2 Channel A4 in the diagram #3 with line thickness 2
GRID:CHAnnel ?	Returns the set-up of the selected channel	
COLOR	P1,P2,P3 Color of each channel P1 = value of red (from 0 to 100) P2 = value of green P3 = value of blue	CHAN A2,COLOR 100,100,100
DEFLOG	P1,P2,P3,P4,P5 Set-up of the logic channels P1 = Number of the logic channel P2 = value of red (from 0 to 100) P3 = value of green P4 = value of blue	

15.5.11. Direct display

SCREEN	P1 Set-up of the display mode P1 = FT, TEXT or XY	SCREEN FT
SCREEN:FT	P1,P2,P3 Set-up in F(T) P1:VER or HOR for vertical or horizontal P2:BOUNON or BOUNOFF to display the boundaries P3:FULLON or FULLOFF for full-screen display or not	PAGE SCOPE;SCREEN FT;;SCREEN VER,BOUNON,FULLON vertical full-screen display
SCREEN:XY	P1,P2 Set-up in Y P1 = X channel of A1,A2, etc. P2 = CHANNEL Y turns to ALL for all channels ON or A1,A2 for only one channel P3 = DOT,VECTOR	SCREEN:XY A3,A2,DOT
SCREEN:TIMEBASE	P1,P2 Set-up of the time basis in scope mode P1 = value (from 1 to 500) P2 = MICRO, MILLisec, Sec, MIn or HOurs	SCOPE:TIMEBASE 500,MS;;SCREEN FT;;PAGE SCOPE;;SCOPE:RESTART
SCREEN:RUN	P1 Starts or stops the scope mode P1 = ON or OFF Stops the scope mode	You change the time basis, then you position yourself in the scope screen f(t)
SCREEN:RUN ?	Returns the scope mode	
SCREEN:TRIG	P1,P2,P3,P4 Tirgger in f(t) mode for fast speed P1 = Number of channel P2 = POS or NEG P3 = Level (0-100) P4 = Position (0-100)	

15.5.12. Mathematical functions

MATH	P1 Number of mathematical functions (from 0 to 5) P1 = FT, TEXT or XY	MATH 3
MATHDEF	P1,P2,P3 Set-up of a function P1 : Number of the function P2 : Selected channel P3 : function MIN MAX PK_PK LOW HIGH AMPL P_OVERSH N_OVERSH FREQ PERIOD R_EDGE F_EDGE P_WIDHT N_WIDTH P_DUTTY_CYCLE N_DUTTY_CYCLE MEAN MEAN_CYC RMS RMS_CYC	MATHDEF 1,A1,MIN
MATH ?	Reading the values of functions You need the f(t) mode to get the values	

15.5.13. Memory output

HEADER	PARAMETERS	EXAMPLES
OUTBloc	P1,P2,P3 Set-up of the block and of the output window P1 = 1 to 128 number of block P2 = from 0 to 100 (real percent of start) P3 = from 0 to 100 (real percent of end)	OUTBLOC 1,25.2,80 block 1, start at 25.2%, stop at 80 %
OUTBloc ?	Returns the command	
OUT:REC	P1,P2 Set-up of the type of paper output P1 : FT or XY paper output P2 : Defines the output reduction rate in FT mode (from 1 to 10000, increments 1,2,5) or the reticule width in XY mode (100, 200 or 250)	OUT:REC XY,200 200x200 paper XY diagram OUT:REC FT,100 F(t) mode, 100 samples / mm
OUT:REC ?	Returns the command	
PLOTRec	P1 Starts or stop the plot on screen P1 = ON or OFF	
PLOTRec ?	Returns the plot and the plotted percentage	
DEFPACQ	P1,P2 P1 : number of the packet to send P2 : number of octets in the packet	OUTBLOC 2,0,100;:DEFPACQ Recovery of the 1st packet in block 2 (10000 octets)
READPACQ ?	Reading the packet defined by DEFPACQ in binary *4octets : length of the packet *4octets : number of the received packet *4octets : checksum of the packet *4octets : length of the total file (for the packet #0 only)	:DEFPACQ 1,10000; READPACQ ? Recovery of the next packet

15.5.14. Request of service

Refers to the explanations about the structure of the status data.

HEADER	PARAMETERS	EXAMPLES																											
SRQ_ENABLE	P1 Allows you to modify the validation log of alarms P1 = value of the log <table border="1"> <thead> <tr> <th>bit</th> <th>decimal</th> <th>use</th> </tr> </thead> <tbody> <tr> <td>0</td> <td>1</td> <td>draw start</td> </tr> <tr> <td>1</td> <td>2</td> <td>draw end</td> </tr> <tr> <td>2</td> <td>4</td> <td>writing end</td> </tr> <tr> <td>3</td> <td>8</td> <td>paper end</td> </tr> <tr> <td>4</td> <td>16</td> <td>open table</td> </tr> <tr> <td>5</td> <td>32</td> <td>data acquisition start</td> </tr> <tr> <td>6</td> <td>64</td> <td>data acquisition end</td> </tr> <tr> <td>7</td> <td>128</td> <td>acquisition trigger</td> </tr> </tbody> </table>	bit	decimal	use	0	1	draw start	1	2	draw end	2	4	writing end	3	8	paper end	4	16	open table	5	32	data acquisition start	6	64	data acquisition end	7	128	acquisition trigger	SRQ_ENABLE 3 3 = 1 + 2, which means bits 0 and 1 The start and end of drawing will be specified in the log of service requests
bit	decimal	use																											
0	1	draw start																											
1	2	draw end																											
2	4	writing end																											
3	8	paper end																											
4	16	open table																											
5	32	data acquisition start																											
6	64	data acquisition end																											
7	128	acquisition trigger																											
SRQ_ENABLE ?	Returns the value of the validation log of alarms																												
SRQ_TYPE ?	Returns of the value of the status log of alarms. The log is then erased. The set-up of each bit is identical of the one of SRQ_ENABLE	SRQ_TYPE ? the recorder returns: SRQ_TYPE 4 i.e. "a writing procedure has ended"																											

15.6. Error messages

When a problem arises in the programming of the recorder through the interface, a debug window pops up on screen to help you identify your mistake:

# error	Explanation
1	Unknown header
2	Unknown parameter
3	Forbidden parameter
4	Absent parameter
5	Wrong parameter separator
6	Wrong message separator
7	Too long word
8	Wrong format for text parameter
9	Forbidden request
10	Digital parameter out of range
11	Text parameter out of range
12	Compulsory request
13	Full emission buffer
14	Impossible in this context
15	Checksum error

At each error matches a line that specifies:

- an error number
- the received message

When the window is full, error are displayed from the first line.

The last error line is followed with a blank line.

16. TECHNICAL SPECIFICATIONS

16.1. Isolated inputs

16.1.1. General characteristics

Number of inputs: 2 or 4 according to the appliance

Impedance:

Impedance > 25 MΩ for calibers < 1V
Impedance = 1 MΩ for the other calibers

Max. acceptable tensions:

between the 2 terminals of a channel: +500 V_{DC} or 500 V_{AC} 50Hz

Installation category: overvoltage category: III 600V

Insulation: double insulation between the mechanical ground and the measurement channel:
>100 MΩ @ 500V DC.

Common mode parasites: test according to EN 61143

Accessible current < 0.75mA

Type of measurements:

Tension, intensity (through external shunt)
Frequency
Thermocouple J, K, T, S, B, N, E, C, L

16.1.2. Tension recording

max caliber	1000V	(-500V to +500V)
min caliber	1mV	(-0.5mV to +0.5mV)
offset	adjustment of the center by 1/5000 of full scale or ½ caliber	
max offset	+ 5 calibers (up to ± 500V)	
accuracy	± 0.1% of full scale ± 10μV ± 0.1% of the offset	
offset drift	100ppm/°C ± 1μV/°C	

Class C index see annexes

16.1.3. RMS recording

Software RMS calculation:

sampling: 200µs
 max. frequency: 500Hz
 peak factor : 2.2 and 600V max. instant
 accuracy: ± 1% (sine signal)
 answering time: typical 100ms (40ms @ 50Hz)
 max. measurable tension: 424 V AC

16.1.4. Temperature recording

Sensor	Domain of use
J	-210°C to 1200°C
K	-250°C to 1370°C
T	-200°C to 400°C
S	-50°C to 1760°C
B	200°C to 1820°C
E	-250°C to 1000°C
N	-250°C to 1300°C
C	0°C to 2320°C
L	-200°C to 900°C

The accuracy of the thermocouples is specified in append.

Compensation of the cold welding of the thermocouples J, K, T, S, N, E, C, L: ± 1.25°C

Calculation every ca. 5ms.

16.1.5. Frequency recording:

sensitivity min 100mV RMS
 decision threshold variable from -99V and 99V with 0.1V increment
 (valid for frequencies < 10Hz)
 min cyclic ratio 10%
 frequency between 0.1Hz and 100kHz
 accuracy 0.02% of full scale

16.1.6. Enregistrement en Comptage :

decision threshold variable from -99V and 99V with 0.1V increment
 min sensitivity +100mV + 1% of the decision threshold
 max count while recording 65536 (beyond this limit, the counter is reset)
 max digital count 4E⁹

16.1.7. Sampling

definition	14 bits
max sampling period:	
memory and file modes:	1 μ s (i.e. 1MHz)
direct mode:	200 μ s (i.e. 5kHz)
max sampling period	10min

16.1.8. Bandwidth

Bandwidth @ -3 dB:	
Caliber	Bandwidth
> 1 V	100 kHz
> 50 mV	50 kHz
20 mV	30 kHz
10 mV	30 kHz
5 mV	20 kHz
Internal analogic filters:	10 kHz, 1 kHz, 100 Hz, 10 Hz
Slope:	20 dB/decade
Software filters:	10 Hz, 1 Hz, 0.1 Hz, 0.01 Hz, 0.001 Hz
Slope:	40 dB/decade

16.2. Additional inputs / outputs

16.2.1. Logic channels

Number of channels	16
Input impedance	4.7 k Ω
Sampling frequency	identical to the main inputs
max acceptable tension	24 V Category 1

16.2.2. Alarm outputs

A & B alarms	0-5V outputs
on trigger (see chapter 17.7)	
on data acquisition trigger	

16.2.3. External power supply

nominal tension	battery tension (from 9 to 15 V)
max. current	0.2 A limited by resettable fuse

16.3. Optional inputs with platinum resistance

PT100 or PT1000	
2 channels	
Power supply output:	
• PT100: 1 mA	
• PT1000: 100 μ A	
20 bit converter.	
domain of use:	-200 $^{\circ}$ C to 850 $^{\circ}$ C
2, 3 or 4 wires	
correction resistance 2 wires:	max 30 Ω
max resistance 3 wires:	50 Ω .
accuracy @ 20 $^{\circ}$ C:	+0.2 $^{\circ}$ C
temperature drift:	0.01 $^{\circ}$ C/ $^{\circ}$ C

16.4. Triggers

The triggers are identical for every various modes

- date
- delay
- thresholds and combinations (or/and) of thresholds (2 thresholds per channel)
- channel slopes (calculation on 10 ms to 1 s periods)
- parasites (50 Hz signal)
- word on logic channels (and, or, rising, level)

16.5. Memory data acquisition

Memory length	32 Mwords (segmentable up to 128 blocks)
max. sampling period	10 min
max. sampling frequency	1 MHz
trigger position	-100% to +100%

Possible stop on a second trigger

Possible trigger on a template (1 channel)

Possible real-time save to file.

16.6. Data acquisition to file

size of the internal flash disk	8 Go min
min transfer rate	100 kwords/s
Trigger:	see paragraph 17.7
Pre-trigger:	variable from 0 to 100.000 samples

The real transfer rate depends on the number of channels to scan and on the current mode.

16.7. Network analysis

These accuracy values require that the nominal values are correct.

16.7.1. Ranges and accuracies for tension and intensity

Root mean square tension:

- range: from 1 mV_{RMS} to 400 V_{RMS}
- Accuracy: 0.5% of the nominal tension.

Root mean square current:

- Range: Current values are always referred to as tensions: the input values must be within the specified limits for the tension. In most cases, the instrument you are using to measure the current shall condition the measurement range.
- Accuracy: 0.5% of nominal current + margin of error for the measurement instrument

Active power:

- Accuracy: margin of error for current + margin of error for tension.

Example

The measurement of 230 V tension and 10 A intensity with a SP221 clamp (1% accuracy; 1 A in input yields 100 mV in output on the network analyzer).

- Tension: 0.5% accuracy
- Current: 0.5%+1%=1.5% accuracy
- Power: 0.5+1.5=2% accuracy

Magnetic fields:

The current sensors you use must conform to the valid norms with CE mark. The influence on the recorder is negligible under a 100A/m 0-50Hz field. As far as possible, keep the sensors away from any magnetic source.

16.7.2. Frequency

Range: from 10 to 100 Hz
 Accuracy: 0.01 Hz
 Sensitivity: 5% of the nominal tension

16.7.3. Power factor

Accuracy: measurement value \pm 0.05

16.7.4. Peak and peak factor

Peak accuracy: 0.5% of the nominal tension or intensity
 Peak factor: 1% accuracy up to 5

16.7.5. Rate of harmonics as calculated in power analysis

Range:	THD: from 0% to 600%
	FD: from 0% to 100%
Accuracy:	measurement value \pm 2.5%
Harmonics:	from ca. 2 up to ca. 50
Range:	from 0% to 600%
Accuracy:	measurement value + 1% up to the 30 th harmonic
	measurement value + 1.5% between the 31 st and the 50 th harmonic

16.8. Printer option

Paper size	110 mm
Drawing size	104 mm
Scrolling speed of the paper	from 1 mm/min to 25 mm/s
Transcription into memory	max. 10 mm/s
Text mode	period from 1 s / line to 1 line / hour
XY mode	100 x 100 mm
Resolution and accuracy:	8 dots / mm
Accuracy of the scrolling speed	1%
Accuracy relatively to the reticule	0.01%

16.9. Communication interface

16.9.1. Ethernet

<i>Speed</i>	10/100 base-T
<i>Connector</i>	RJ45
<ul style="list-style-type: none"> • DHCP possible. • FTP server • Remote control: 	
<i>Protocol</i>	TCP/IP
<i>Connection port</i>	23

16.9.2. USB connectors

For memory keys only	
<i>Standard</i>	USB 2
<i>Type</i>	2 female connectors type A

16.10. Display

Screen	TFT 10", color, backlit
Total definition	1024 x 600 dots

16.11. Environment conditions

16.11.1. Weather conditions

<i>Working temperature</i>	0°C to 40°C
<i>max. relative humidity</i>	80 % non-condensing
<i>Storage temperature</i>	-20°C to 60°C

16.12. Power supply - battery

External power supply:	mains block 100/240 VAC, jack 5.5 mm, hole 2.1 mm output 15 V 4 A max
------------------------	---

Non-removable battery:	lithium ion 10.8 V, 6.5 Ah (9 V at end of discharge) 200 cycles charge / discharge
------------------------	---

Battery life:	pending
---------------	---------

16.12.1. Dimensions and weight

<i>Height</i>	210 mm
<i>Width</i>	295 mm
<i>Depth</i>	105 mm
<i>Weight</i>	2,5 kg (4 channels + PT100 without printer) + 250 g with printer and paper roll

16.13. Electromagnetic compatibility, Security

16.13.1. Electromagnetic compatibility according to EN 61326-1 and 61326-1-2

Normes : EN 61326-1 (2013) [R](#) et EN 61326-2-1 (2013)
EN 55011 (2009 + A1/2010) [R](#)

Emission pour les environnements industriels (Classe A).

ESSAI D'EMISSION	LIMITES			RESULTATS (Commentaires)
Emissions conduites sur le secteur 150kHz-30MHz	Fréquence	Valeur Quasi-crête (dB μ V)	Valeur moy. (dB μ V)	CONFORME
	150-500kHz	79	66	
	0.5-30MHz	73	50	
Emissions rayonnées 30MHz-1GHz	Mesure à 10m (Quasi-crête) 30MHz-230MHz : 40 dB μ V/m 230MHz-1GHz : 47 dB μ V/m			CONFORME

ESSAI D'IMMUNITE	NIVEAU D'ESSAI	Critère d'aptitude exigé	RESULTATS (Commentaires)
Décharges électrostatique (ESD) EN 61000-4-2 (2009) R	\pm 4kV Décharges au contact \pm 8kV Décharges dans l'air	B	CONFORME
Immunité rayonnée aux champs RF EN 61000-4-3 (2006+A1/2008+A2/2010) R	10V/m AM 80%, 1kHz ; 80MHz à 1GHz 3V/m AM 80%, 1kHz ; 1.4 à 2.0GHz 1V/m AM 80%, 1kHz ; 2.0 à 2.7GHz	A	CONFORME
Transitoires rapides en salve (TRS) EN 61000-4-4 (2004+A1/2010) R	\pm 2kV : entrée d'alimentation AC \pm 2kV : accès puissance DC \pm 2kV : lignes de signaux et commande directement connecté au secteur \pm 1kV : lignes de signaux (1)	B	CONFORME
Immunité aux ondes de choc. Alimentation secteur AC ou DC.et lignes de signaux/commande directement connecté au secteur EN 61000-4-5 (2006) R	\pm 1kV en mode différentiel \pm 2kV en mode commun	B	CONFORME
Immunité aux ondes de choc. Lignes de signaux EN 61000-4-5 (2006) R	\pm 1kV entre ligne et terre (2)	B	NA
Immunité conduite RF EN 61000-4-6 (2009) R	3V AM 80%, 1kHz 150kHz à 80MHz (3)	A	CONFORME
Immunité aux champs magnétiques à la fréquence du réseau EN 61000-4-8 (2010) R	30 A/m à 50Hz et 60Hz (4)	A	NA
Variations et coupures brèves de tension EN 61000-4-11 (2004) R	0% (tension résiduelle) sur 1 période 40% (tension résiduelle) sur 10/12 périodes 70% (tension résiduelle) sur 25/30 périodes 0% (tension résiduelle) sur 250/300 périodes (5)	B C C C	CONFORME

(1) : Uniquement pour les liaisons dont les câbles peuvent être supérieurs à 3m.

(2) : Uniquement pour les liaisons dont les câbles peuvent être supérieurs à 30m.

(3) : Lignes de signaux : uniquement pour les liaisons dont les câbles peuvent être supérieurs à 3m.

(4) : Applicable seulement aux équipements contenant des composants sensibles aux champs magnétiques

(5) : 10, 25 et 250 périodes pour des essais à 50Hz ; 12, 30 et 300 périodes pour des essais à 60Hz

NA : Non Applicable

NE : Non Effectué

ND : Non demandé par le client (Cet essai n'a pas été effectué à la demande du client et ne peut donc pas être pris en compte pour la déclaration de conformité)

16.13.2. Security, insulation class, installation category

Security class: handy appliance for use on field

<i>Security</i>	conform to EN61010-1 (2001-02)
<i>Pollution degree</i>	2
Power supply by 15 V external block	code 207195117

Installation category (overvoltage category)

Measurement input	category III 600 V, overvoltage 6000 V
Other input/output	measurement category I (CAT I)



The carter of the appliance is grounded if the mains block is connected to the recorder

16.14. Accessories

16.14.1. Accessories provided with the appliance

User's manual	
Assistance CD with software and notices	
Battery charger	207195117

Common accessories:

• 1 male 25-pin connector	214200250
• 1 connector plug	214299014

Printer accessories:

• 1 paper roll	837500526
----------------	-----------

Accessories for 2-channel module:

• 1 black pin plug per channel	215508020
• 1 red pin plug per channel	215508021
• Red 1mm security cord	4310-4I-100-R
• Black 1mm security cord	4310-4I-100-N
• Red security clamp	5004-IEC-R
• Black security clamp	5004-IEC-N

16.14.2. Accessoires et options

Transportation briefcase	902001000
Shunt 0.01 Ω 1% 3 A plug-in	910007100
Shunt 0.1 Ω 1% 1 A plug-in	910007200
Shunt 1 Ω 0.1% 0.5 A plug-in	989006000
Shunt 10 Ω 0.1% 0.15 A plug-in	912008000
Shunt 50 Ω 0.1% 0.05 A plug-in	989007000
Shunt 0.01 Ω 0.5% 30 A external (pins)	207030301
Shunt 0.001 Ω 0.5% 50 A external (terminals)	207030500
Current clamp	SP120... SP270
Flexible current clamp 30/300/3000 A	A1257 (3-phase)-A1287 (mono)
Logic box	9844005500
FLEXPLO software basis	910008100
FLEXPLO software complete	910008200
Crossover Ethernet cable	910007300

16.14.3. Consumables

Paper roll	837500526
Set of accessories for 2 channels	7004000

17. APPENDS

17.1. Information about the input calibers

Reminder:

The caliber is the difference between the max. and min. values that you can display on screen or on paper.

The origin is the center of the screen or of the paper.

17.1.1. Insulated tension type inputs

These inputs are equipped with an analogical offset system that may reach up to ± 5 caliber values. Hence, you cannot shift the measurement stops without changing the definition up to 5 caliber values.

The software allows you to program any caliber and any offset; it selects then the real analogical caliber and offset best suitable according to the table below (closest upper caliber and offset)

CALIBER	Origin offset	Min measurable	Max measurable
1mV	$\pm 5\text{mV}$	-5.5mV	+5.5mV
2mV	$\pm 10\text{mV}$	-11mV	+11mV
5mV	$\pm 25\text{mV}$	-27.5mV	+27.5mV
10mV	$\pm 50\text{mV}$	-55mV	+55mV
20mV	$\pm 100\text{mV}$	-110mV	+110mV
50mV	$\pm 250\text{mV}$	-275mV	+275mV
100mV	$\pm 500\text{mV}$	-550mV	+550mV
200mV	$\pm 1\text{V}$	-1.1V	+1.1V
500mV	$\pm 2.5\text{V}$	-2.75V	+2.75V
1V	$\pm 5\text{V}$	-5.5V	+5.5V
2V	$\pm 10\text{V}$	-11V	+11V
5V	$\pm 25\text{V}$	-27.5V	+27.5V
10V	$\pm 50\text{V}$	-55V	+55V
20V	$\pm 100\text{V}$	-110V	+110V
50V	$\pm 250\text{V}$	-250V	+250V
100V	$\pm 450\text{V}$	-500V	+500V
200V	$\pm 400\text{V}$	-500V	+500V
500V	$\pm 250\text{V}$	-500V	+500V
1000V	0	-500V	+500V

17.2. Measurement accuracy for thermocouple

The thermocouple measurements are treated as tension measurements.

For a given range of temperature measurement, the software calculates the tension caliber the following way:

- * Let « T » the absolute value of the max. measurable value, in °C
- * Add 40°C to take the max. cold welding temperature into account
- * Search the corresponding tension value U in the table of thermocouples
- * Program the caliber with U included in the range.

Example:

You want to program a measurement range between -50 and + 50°C with a J thermocouple:

- Max. absolute value T = 50°C
- Add 40°C T + 40 = 90°C
- Corresponding U tension according to the tables ThJ U = 4.726 mV
- Programmed caliber: 10 mV (measurement range: -5mV to +5mV)

The measurement inaccuracies below are max. values: the typical values are half to thrice as much.

The temperature measurement accuracy is the sum of several possible uncertainty causes:

Pl: linearization accuracy

Ps: weld welding accuracy

Pm: measurement accuracy of the equivalent tension

The total accuracy Pt is then: $Pt = Pl + Ps + Pm$

For the recorder:

$Pl = \pm 0.25^\circ\text{C}$ for all thermocouples

$Ps = \pm 1.25^\circ\text{C}$ for all thermocouples

$Pm = 0.1\%$ of the tension caliber + 10µV) divided by the slope of the thermocouple in µV/°C

Measurement accuracy: Pm

The measurement accuracy Pm depends on the tension caliber of the appliance (see the previous paragraph) and on the slope of the thermocouple. You shall take the slope at 0°C while knowing that it will vary as a function of the temperature, but this variation is generally of the second order for the accuracy calculation.

Slope of the thermocouples:

J	K	T	S	B
50µV/°C (@ 0°C)	40µV/°C (@ 0°C)	10µV/°C (@ 0°C)	10µV/°C (@ 500°C)	9µV/°C (@ 1000°C)

E	N	C	L
60µV/°C (@ 0°C)	26µV/°C (@ 0°C)	18µV/°C (@ 1000°C)	50µV/°C (@ 0°C)

EXAMPLE OF ACCURACY CALCULATION

You make a welding between -50°C and +50°C with a J thermocouple with compensation of cold welding.

$$P_t = P_l + P_s + P_m + P_d$$

$$P_l = \pm 0.25^\circ\text{C} \text{ (linearization accuracy)}$$

$$P_s = \pm 1.25^\circ\text{C} \text{ (compensation of cold welding)}$$

Used caliber	10mV (see previous example)
Accuracy for tension measurement	$0.1\% * 10\text{mV} + 10\mu\text{V} = 20\mu\text{V}$
Slope of J thermocouple	50 $\mu\text{V}/^\circ\text{C}$
Accuracy Pm	$P_m = 20/50 = 0.4^\circ\text{C}$
Total accuracy	$P_t = 0.25 + 1.25 + 0.4 = 1.9^\circ\text{C}$

17.4. Instant measurement accuracy as a function of the filters

The instant measurement accuracy is specified with a 10Hz filter: $\pm 0,1\%$ of full scale $\pm 10\mu\text{V}$ $\pm 0.1\%$ of the offsets

For filters with higher frequency and for low calibers (great gain), the noise becomes more intense (the product gain \times bandwidth is constant): you have to add some specification about the noise; i.e. it is not possible to get an instant measurement accuracy of 0.1% on the 1mV caliber without a filter.

The table below gives you the typical noise peak-to-peak for various calibers and filters, as % of the caliber:

Caliber	1mV	2mV	5mV	10mV	20mV	50mV	100mV	200mV	>200mV
Filter	1kHz	1kHz	1kHz	10kHz	10kHz	10kHz	none	none	none
Typical noise	3%	1.5%	0.7%	1%	0.6%	0.2%	0.6%	0.5%	0.3%

The noise is proportional to the square root of the bandwidth. To assess the noise on other positions of filters, you only have to calculate the square root of the ratio of bandwidths.

Example:

Noise on 10mV with a 10Hz filter?

Noise = 1% with a 10kHz filter

$$\text{Ratio} = \sqrt{10000/10} = 32$$

Thus, the noise will be divided by 32

Noise = 0.03% with a 10Hz filter

17.5. Accuracy class – class index

This is one of the most important concepts of the CEI recommendation; it tends to shorten the list of specifications. To do so, it introduces the concept of PREDICTIVE CLASS that depends on the C CLASS INDEX.

The normalized values of the class index are: C = 0.1, 0.25, 0.5 and 1.

The intrinsic error (in the reference conditions) does not exceed $\pm C\%$ (the manufacturer may also specify this limit of the intrinsic error as an absolute value (ex. $\pm 5\mu\text{V}$) for the first calibers).

The variations (of the measured value) with the variations of one of the influential variables in the nominal range of use do not exceed:

- C % for the position for the magnetic induction with external source and parasite tensions
- 0.5 C% for the power supply source
- 0.3 C% according to the class index at ambient temperature (0.15% for the 0.25 class).

In addition, the insensitivity range should not exceed:

- C% in the reference conditions
- 1,5C% for the maximal resistance of the external measurement circuit
- 2C% for parasite tensions

And the excess should not be more than 2C% (4C% within the limits of the power supply source).