



UK
CA
CE

PVCHECKS-PRO

User manual



TABLE OF CONTENTS

1. PRECAUTIONS AND SAFETY MEASURES	3
1.1. Preliminary instructions	3
1.2. During use	4
1.3. After use	4
1.4. Definition of measurement (overvoltage) category	4
2. GENERAL DESCRIPTION	5
2.1. Foreword	5
2.2. Instrument functions	5
3. PREPARATION FOR USE	6
3.1. Initial checks	6
3.2. Instrument power supply	6
3.3. Storage	6
4. NOMENCLATURE	7
4.1. Description of the instrument	7
4.2. Keyboard description	8
4.3. Initial screen	8
5. GENERAL MENU	9
5.1. SET – instrument settings	9
5.1.1. Language	9
5.1.2. Date and time	10
5.1.3. General settings	10
5.1.4. Irradiance	10
5.1.5. Info	10
5.1.6. Operator name	11
6. OPERATING INSTRUCTIONS	12
6.1. DMM – Multimeter function	12
6.2. UREM – Remote unit	13
6.3. RPE – Continuity measurement on PV modules/strings/fields	16
6.3.1. Calibration of measuring cables	16
6.3.2. Carrying out continuity measurements in Standard (STD) mode	18
6.3.3. Carrying out continuity measurements in Timer (TMR) mode	20
6.3.4. Anomalous situations	22
6.4. M Ω – Measurement of insulation on PV modules/strings/fields	23
6.4.1. Measuring insulation – DUAL mode	23
6.4.2. Measuring insulation – TMR mode	25
6.4.3. Anomalous situations	28
6.5. GFL – Searching for conditions of low insulation on PV strings	30
6.6. DB – Module database management	34
6.6.1. How to define a new PV module	34
6.6.2. How to modify an existing PV module	36
6.6.3. How to delete an existing PV module	36
6.7. IVCK - Test on PV modules and strings	37
6.7.1. Foreword	37
6.7.2. Carrying out IVCK Tests without remote unit	38
6.7.3. Carrying out IVCK Tests with remote unit	42
6.7.4. Anomalous situations	49
6.8. List of display messages	52
7. STORING RESULTS	53
7.1. Saving measures	53
7.2. Recalling and deletion of saved data	54
8. CONNECTING THE INSTRUMENT TO THE PC	55
9. MAINTENANCE	56
9.1. General information	56
9.2. Battery replacement	56
9.3. Cleaning the instrument	56
9.4. End of life	56

10. TECHNICAL SPECIFICATIONS	57
10.1. Technical characteristics	57
10.2. General characteristics.....	58
10.3. Environmental conditions for use	59
10.4. Accessories	59
11. APPENDIX – THEORETICAL OUTLINE	60
11.1. Measurement of polarization index (PI).....	60
11.2. Dielectric Absorption Ratio (DAR)	60
12. ASSISTANCE	61
12.1. Warranty conditions.....	61
12.2. Assistance	61

1. PRECAUTIONS AND SAFETY MEASURES

The instrument has been designed in compliance with directive IEC/EN61010-1 relevant to electronic measuring instruments. Before and while carrying out measurements, observe the following indications and read all notes preceded by the symbol  with the utmost attention.

- Do not carry out any voltage or current measurement in humid environments
- Do not carry out any measurements in case gas, explosive materials or flammables are present, or in dusty environments
- Avoid any contact with the circuit being measured if no measurements are being carried out.
- Avoid contact with exposed metal parts, with unused measuring probes, etc.
- Do not carry out any measurement in case you find anomalies in the instrument such as deformation, breaks, absence of display on the screen, etc.
- Pay special attention when measuring voltages higher than 25V in special environments and 50V in normal environments, since a risk of electrical shock exists.

In this manual, and on the instrument, the following symbols are used:



Warning: observe the instructions given in this manual; improper use could damage the instrument or its components.



High voltage danger: electrical shock hazard.



Double insulation



DC Voltage or Current



AC Voltage



Connection to earth

1.1. PRELIMINARY INSTRUCTIONS



- **The instrument has been designed to be used in the environmental conditions specified in § 10.3. The presence of significantly different environmental conditions can compromise the safety of the instrument and the operator. In any case, before using, wait until the conditions inside the instrument are comparable to the conditions of the environment in which it is operating**
- The instrument may be used for measuring **VOLTAGE** and **CURRENT** in CAT III 1500V DC, CAT III 1000VAC with maximum voltage 1500VDC and 1000V AC between inputs. Do not use on circuits exceeding the limit values specified in § 10.1
- We recommend following the normal safety rules devised to protect the user against dangerous currents and the instrument against incorrect use.
- Only the accessories provided together with the instrument will guarantee safety standards. They must be in good conditions and replaced with identical models, when necessary.
- Make sure that batteries are correctly installed.
- Before connecting the measuring cables to the circuit being measured, check that the desired function has been selected.

1.2. DURING USE

Please carefully read the following recommendations and instructions:



CAUTION

- Failure to comply with the caution notes and/or instructions may damage the instrument and/or its components or be a source of danger for the operator.
- The symbol “” indicates a full charge level of the internal batteries. When battery charge decreases to a minimum level, the symbol “” appears on the display. In this case, stop testing and replace the batteries according to the indications given in § 9.2
- **The instrument can keep data stored even without batteries.**

1.3. AFTER USE

When measurements are complete, switch off the instrument by pressing and holding the **ON/OFF** key for some seconds. If the instrument is not to be used for a long time, remove the batteries and follow the instructions given in § 3.3.

1.4. DEFINITION OF MEASUREMENT (OVERVOLTAGE) CATEGORY

Standard “IEC/EN61010-1: Safety requirements for electrical equipment for measurement, control and laboratory use, Part 1: General requirements”, defines what measurement category, commonly called overvoltage category, is. At § 6.7.4: Measured circuits, reads:

Circuits are divided into the following measurement categories:

- **Measurement category IV** is for measurements performed at the source of the low-voltage installation.
Examples are electricity meters and measurements on primary overcurrent protection devices and ripple control units.
- **Measurement category III** is for measurements performed on installations inside buildings.
Examples are measurements on distribution boards, circuit breakers, wiring, including cables, bus-bars, junction boxes, switches, socket-outlets in the fixed installation, and equipment for industrial use and some other equipment, for example, stationary motors with permanent connection to fixed installation.
- **Measurement category II** is for measurements performed on circuits directly connected to the low-voltage installation.
Examples are measurements on household appliances, portable tools and similar equipment.
- **Measurement category I** is for measurements performed on circuits not directly connected to MAINS.
Examples are measurements on circuits not derived from MAINS, and specially protected (internal) MAINS-derived circuits. In the latter case, transient stresses are variable; for that reason, the standard requires that the transient withstanding capability of the equipment is made known to the user.

2. GENERAL DESCRIPTION

2.1. FOREWORD

This instrument has been designed to carry out quick tests (IVCK) on photovoltaic (PV) modules/strings in compliance with standard IEC/EN62446.

2.2. INSTRUMENT FUNCTIONS

The instrument has the following features:

Continuity test of protective conductors (RPE)

- Test with test current > 200mA in compliance with standards IEC/EN62446, and IEC/EN61557-4
- Manual calibration of measuring cables.

Measurement of insulation resistance on PV modules/strings (M Ω)

- Test voltages of 250V, 500V, 1000V, 1500VDC in compliance with standards IEC/EN62446 and IEC/EN61557-2
- 2 available measuring modes
 - DUAL → Measurement in a sequence of the insulation between the string's positive pole (+) and PE and between the string's negative pole and PE.
 - TMR → single timed measurement between the string's negative pole and PE.

GFL (Ground Fault Locator) function to search for positions with a low insulation among the modules of a PV string (see § 6.5).

Measurement of open-circuit voltage and short circuit current on monofacial or bifacial PV modules/strings in compliance with standard IEC/EN62446 (IVCK)

- Measurement of open-circuit voltage Voc on monofacial and bifacial PV modules/strings up to 1500VDC.
- Measurement of short-circuit current Isc on monofacial and bifacial PV modules/strings up to 40A.
- Measurement of front and back irradiance through Bluetooth with remote unit SOLAR03 and reference cell HT305
- Display of results in OPC and STC conditions
- Immediate evaluation (OK/NO) of test results

The instrument is also provided with an internal Database capable of storing up to 64 PV modules (**to be uploaded by the user**), with backlit display, internal contrast adjustment and a **HELP** key able to give a valid help to the operator while connecting the instrument to the installation. An AutoPowerOFF function, which can also be deactivated, is available after approx. 5 minutes

3. PREPARATION FOR USE

3.1. INITIAL CHECKS

Before shipping, the instrument has been checked from an electric as well as a mechanical point of view. All possible precautions have been taken so that the instrument is delivered undamaged. However, we recommend checking it to detect any damage possibly suffered during transport. In case anomalies are found, immediately contact the dealer. We also recommend checking that the packaging contains all components indicated in § 10.4. In case of discrepancy, please contact the Dealer. In case the instrument should be returned, please follow the instructions given in § 12

3.2. INSTRUMENT POWER SUPPLY

The instrument is powered by 6x1.5V alkaline batteries of type AA LR06 or 6 x 1.2V NiMH rechargeable batteries of type AA. The symbol “” indicates the charge level of the batteries. For battery replacement, please refer to § 9.2.

The instrument is capable of keeping data stored even without batteries.

The instrument is provided with advanced algorithms to maximize the batteries life. A short pressing of the  key turns on the display's backlighting. To save battery efficiency, backlighting automatically turns off after approx. 30 seconds. A frequent use of backlighting reduces the batteries life.

3.3. STORAGE

The instrument has been designed to be used in the environmental conditions specified in § 10.3. The presence of significantly different environmental conditions can compromise the safety of the instrument and the operator and/or not guarantee precise measurements. After a long period of storage and/or in extreme environmental conditions, before using, wait until the conditions inside the instrument should be comparable to the conditions of the environment in which it is operating.

4. NOMENCLATURE

4.1. DESCRIPTION OF THE INSTRUMENT

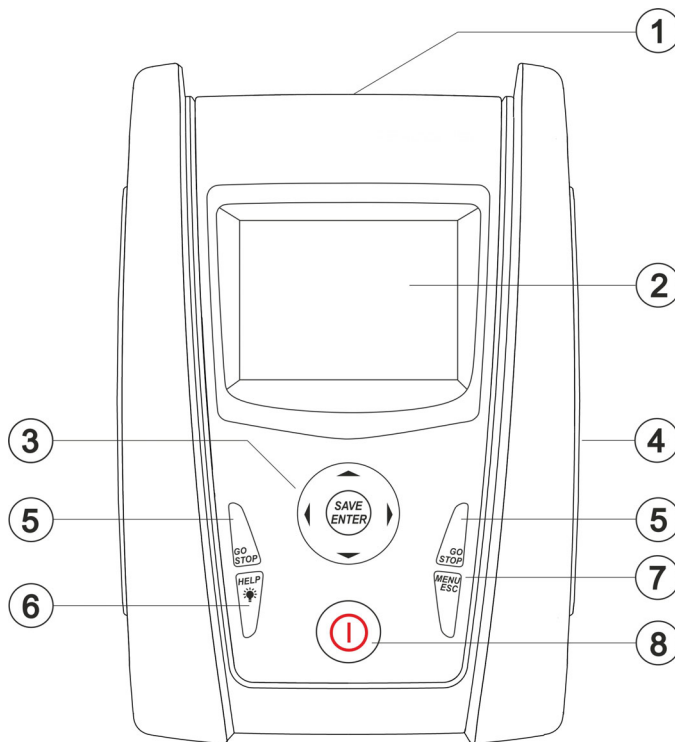

CAPTION:

1. Inputs
2. LCD display
3. Keys $\blacktriangledown, \blacktriangle, \blacktriangleright, \blacktriangleleft$, **SAVE/ENTER**
4. Compartment of connector for optical/USB cable
5. Key **GO/STOP**
6. Key **HELP**
7. Key **ESC/MENU**
8. Key **ON/OFF**

Fig. 1: Description of the front part of the instrument



CAPTION:

1. **P, N** inputs for DC voltage measurement (IVCK) / Insulation ($M\Omega$)
2. **E, C** inputs for continuity tests (RPE)

Fig. 2: Description of the upper part of the instrument

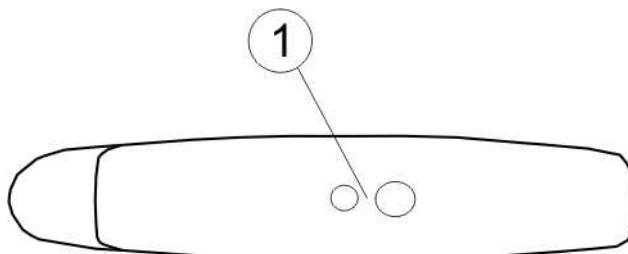

CAPTION:

1. Connector for connecting optically insulated optical/USB output cable

Fig. 3: Description of the instrument's side

4.2. KEYBOARD DESCRIPTION

The keyboard includes the following keys:



ON/OFF key to switch on/off the instrument



ESC key to exit the selected menu without confirming
MENU key to go back to the instrument's general menu at any time



Keys ◀ ▶ ▲ ▼ to move the cursor within the various screens in order to select programming parameters

SAVE/ENTER key to save internal parameters and the results of measurements (SAVE) and to select the desired functions from the menu (ENTER)



GO key to start measuring
STOP key to stop measuring



HELP key to access the help on line and display, for each selected function, possible connections between the instrument and the system

Key ☀ (**long pressing**) to adjust the display's backlight

4.3. INITIAL SCREEN

When switching on the instrument, the initial screen appears for a few seconds. It shows:

- The instrument model (PVCHECKs-PRO)
- The manufacturer's name
- The serial number (SN:) of the instrument
- The hardware (HW) and firmware (FW) version in the instrument's memory
- The date of the last instrument calibration (Calibration date:)

PVCHECKs-PRO

HT ITALIA

SN: 23020002

HW: 1.00

FW: 1.01

Calibration date:

14/02/2023

After a few seconds, the instrument switches to the last function selected.

5. GENERAL MENU

Pressing the **ESC** key in any condition of the instrument allows going back to the general menu, in which internal parameters may be set and the desired measuring function may be selected. Use the cursor to select one of the options and confirm with **ENTER** to access the desired function.

MENU	15/03 – 18:04	MENU	15/03 – 18:04
DMM	: Multimeter	SET	: Settings
UREM	: Remote Unit	MEM	: Data saved
IVCK	: PVTest sequence	PC	: Data transfer
M Ω	: Insulation		
GFL	: Find Insul.fault		
RPE	: Continuity		
DB	: PVMod.Database		
	▼		▼

5.1. SET – INSTRUMENT SETTINGS

Move the cursor to **SET** by using the arrow keys (**▲**, **▼**) and confirm with **ENTER**. The instrument shows the screen which allows access to internal settings. Settings will be maintained also after switching off the instrument.

SET	15/10 – 18:04
Language	
Date and time	
General settings	
Irradiance	
Information	
Operator Name	

5.1.1. Language

Move the cursor to **Language** by using the arrow keys (**▲**, **▼**) and confirm with **ENTER**. The instrument shows the screen which allows setting the system language. Select the desired option by using the arrow keys (**▲**, **▼**). Press the **ENTER** key to confirm or the **ESC** key to go back to the previous screen.

SET	15/10 – 18:04
English	
Italiano	
Español	
Deutsch	
Français	
Portuguese	

5.1.2. Date and time

Move the cursor to **Date and time** by using the arrow keys (▲,▼) and confirm with **ENTER**. Subsequently, the screen to the side appears, so that the system's date/time can be set. Select "Format" to set the European ("DD/MM/YY, hh:mm" **EU**) or American ("MM/DD/YY hh:mm" **USA**) format. Select the desired option by using the arrow keys (▲,▼) and (◀, ▶). Press the **ENTER** key to confirm or the **ESC** key to go back to the previous screen.

SET 15/10 – 18:04	
Format	: ◀ EU ▶
Year	: ◀ 19 ▶
Month	: ◀ 10 ▶
Day	: ◀ 14 ▶
Hour	: ◀ 17 ▶
Minute	: ◀ 38 ▶

5.1.3. General settings

Move the cursor to **General settings** by using the arrow keys (▲,▼) and confirm with **ENTER**. The instrument shows the screen in which it is possible to enable/disable the auto power off function, key sound, display contrast and WiFi connection (see § 8)

Select the desired option by using the arrow keys (▲,▼). Press the **ENTER** key to confirm or the **ESC** key to go back to the previous screen.

SET 15/10 – 18:04	
AutoPowerOff	: ◀ OFF ▶
Key sound	: ◀ OFF ▶
Contrast	: ◀ 50 ▶
WiFi	: ◀ OFF ▶

5.1.4. Irradiance

This section allows setting the minimum irradiance threshold for IVCK measurement.

1. Position the cursor onto "**Irradiance**" by using the arrow keys (▲,▼) and confirm with **ENTER**.
2. The display shows the screen containing item "**Min. Irrad. [W/m²]**", which allows setting the minimum irradiance threshold expressed in W/m², used as a reference for IVCK measurement.
3. To set the minimum irradiance threshold, use the arrow keys (◀, ▶). The value can be set in a range **100 ÷ 1000 W/m²** in steps of **10 W/m²**
4. Press the **SAVE** key to save the settings made; the message "Data saved" will be displayed for a few seconds. Press the **ESC/MENU** key to exit without saving and go back to the previous screen.

SET 15/10 – 18:04	
Min.Irrad.[W/m ²]	: ◀ 100 ▶
Data saved	

5.1.5. Info

Move the cursor to **Info** by using the arrow keys (▲,▼) and confirm with **ENTER**.

The instrument shows the initial screen as indicated in the screen to the side. Press the **ESC** key to go back to the main menu.

15/10 – 18:04	
PVCHECKsPRO	
HT ITALIA	
SN: 23020002	
HW: 1.00	
FW: 1.01	
Calibration date:	
14/02/2023	

5.1.6. Operator name

This option allows including the name of the operator who carried out the measurements using the instrument (**max 12 digits**). The chosen name will be included in the reports created by using the management software.

1. Use the arrow keys ◀ or ▶ to move the cursor to the selected digit and press the **SAVE/ENTER** key to enter.
2. Move the cursor to “DEL” and press the **SAVE/ENTER** key to delete the selected digit.
3. Move the cursor to “OK” and press the **SAVE/ENTER** key to confirm the written name and go back to the previous screen.

SAVE	15/10 – 18:04	
Keyboard		
OPERATOR_		
0 1 2 3 4 5 6 7 8 9 0 () %		
Q W  R T Y U I O P <=> #		
A S D F G H J K L + - * / &		
Z X C V B N M . , ; : ! ? _		
Ä Ö Ü ß µ Ñ Ç Á Í Ó Ú Û ÿ		
Á È É Û Ç Ä Ë Ì Ö Ù Æ Ø Å		
DEL		OK

6. OPERATING INSTRUCTIONS

6.1. DMM – MULTIMETER FUNCTION

In this function, the instrument shows the RMS (root mean square) and DC (average) values of voltages between the positive (+) and negative (-) pole, between the positive (+) pole and earth connection (PE) and between the negative (-) pole and earth connection (PE), in order to check for the presence of AC components on input voltages.

1. Position the cursor onto **DMM** by using the arrow keys (**▲**, **▼**) and confirm with **ENTER**. The display shows the screen to the side.

DMM 15/10 – 18:04		
VPNrms	0	V
VPErms	0	V
VNErms	0	V
VPNdc	0	V
VPEdc	0	V
VNEdc	0	V

2. Connect the instrument to the PV string to be tested as shown in Fig. 4.

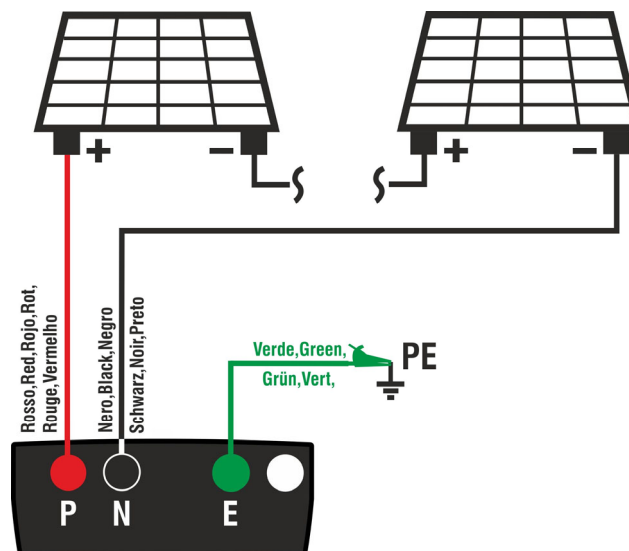

Fig. 4: Instrument connection for DMM Function

3. The voltage values are shown on the display as illustrated in the screen to the side.

DMM 15/10 – 18:04		
VPNrms	1480	V
VPErms	750	V
VNErms	748	V
VPNdc	1420	V
VPEdc	720	V
VNEdc	-726	V



CAUTION

The results of function DMM cannot be saved in the instrument's memory.

6.2. UREM – REMOTE UNIT

This section manages all operations which can be performed by using the remote unit SOLAR03, which can also be used for IVCK measurements. In particular, it is possible to:

- **Through Bluetooth connection**, search for a remote unit **SOLAR03**, which can be managed by the instrument, adding it to the instrument's internal list (**max 5 remote units**);
- Select or cancel a remote unit SOLAR03 among those present in the list;
- Pair/unpair a remote unit SOLAR03 to/from the instrument so that it can be automatically recognized upon every connection;
- Display the information of the selected remote unit.
- Activate/stop recording environmental parameters (temperature/irradiance) on a connected and active remote unit.

In particular, for each managed remote unit SOLAR03, the instrument displays:

- Serial Number
- Item "Act" → active (symbol "√") or inactive (no symbol) remote unit
- Item "Stat." → active connected (symbol "ⓘ") or active disconnected (symbol "i") remote unit
- Item "Rec" → active and connected unit currently recording (symbol "Ⓜ")

To associate a **new** remote unit SOLAR03 to the instrument, proceed as follows:

1. Position the cursor onto **UREM** by using the arrow keys (▲, ▼) and confirm with **ENTER**
2. Use the arrow keys ◀ or ▶ to select item **"Find"** to start searching for a remote unit SOLAR03. The message **"Please wait..."** is shown on the display.

UREM 15/10 – 18:04 			
SOLAR03	Act.	Stat.	Rec
Please wait...			
Find	Pair.	Info	Start

3. The instrument **activates the Bluetooth connection** and shows the screen to the side for a few seconds, searching for a remote unit SOLAR03

UREM 15/10 – 18:04 			
SOLAR03	Act.	Stat.	Rec
SOLAR03 SN: - - -			
Find Remote Unit			

4. On the remote unit SOLAR03, activate “**Pairing**” (refer to user manual of remote unit SOLAR03), so that it can be recognized by the instrument. Once done, the serial number of the remote unit and the message “**Remote unit detected. Pair? (ENTER/ESC)**” appear on the display as shown in the screen to the side.

UREM 15/10 – 18:04				
SOLAR03	Act	Stat.	Rec	
SOLAR03 SN: 23051203				
Remote Unit detected Pair? (ENTER/ESC)				

5. Confirm with ENTER on the instrument and on the remote unit SOLAR03 for pairing. From now on, the instrument and the remote unit are paired and it will not be necessary to repeat these operations. To connect the instrument to the remote unit, it will be sufficient to switch them on, bring them near to each other and wait for pairing.

UREM 15/10 – 18:04				
SOLAR03	Act	Stat.	Rec	
23051203	√	((↑))		
U.Rem. Connected				
Find	Unpair	Info	Start	

6. To start recording on an active and connected remote unit, use the arrow keys ◀ or ▶ and select “**Start**””. The symbol “**oo**” will subsequently appear.

UREM 15/10 – 18:04				
SOLAR03	Act	Stat.	Rec	
23051203	√	((↑))	oto	
U.Rem. Connected				
Find	UnPair	Info	Start	

In case the instrument has previously been associated to two or more remote units, in order to switch from a remote unit to another:

7. Use the arrow keys ◀ or ▶ and select “**UnPair**” and confirm with **ENTER** to unpair the current remote unit. To carry out this operation, it is not necessary that the currently associated remote unit is also connected to the instrument.
8. Use the arrow keys (▲, ▼) to select the new remote unit. The new unit must be switched on and be located within the connection range of the instrument.
9. Use the arrow keys ◀ or ▶ and select “**Pair**” and confirm with **ENTER** to connect the remote unit to the instrument.
10. The previously unpaired unit can also be deleted from the list using “**Del**”.

UREM 15/10 – 18:04				
SOLAR03	Act	Stat.	Rec	
23051203	√	((↑))		
23061215		↑		
U.Rem. Connected				
Find	Unpair	Info	Start	

11. Use the arrow keys ◀ or ▶ to select “Info” to display the following information on the active and connected remote unit SOLAR03:

- Model
- Serial Number
- Internal FW and HW version
- Status of possible ongoing recording
- Residual memory available for recordings
- Status of internal battery

UREM 15/10 – 18:04 	
Remote unit SOLAR03 HT ITALIA	
SN:	23051203
HW:	1.02
FW:	1.00
Status:	No Rec.
Free mem.:	0g, 2h
Battery:	53%

6.3. RPE – CONTINUITY MEASUREMENT ON PV MODULES/STRINGS/FIELDS

The purpose of this measurement is performing a continuity test of the protective and equipotential conductors (e.g.: from rod to earth and connected foreign earth) and earth rods of SPDs on PV installations. The test must be carried out using a test current > 200mA in compliance with standards IEC/EN62446-1 and IEC/EN61557-4.



CAUTION

We recommend a preliminary check of correct functioning of the instrument before carrying out a measurement by shorting input terminals **E** and **C**, checking an almost zero continuity value and an out-of-scale value with terminals E and C open

6.3.1. Calibration of measuring cables

1. Position the cursor onto **RPE** by using the arrow keys (**▲**, **▼**) and confirm with **ENTER**. The display shows the following screen:

RPE	15/10 – 18:04		
R	- - -	Ω	
I _{test}	- - -	mA	
STD	2.00Ω	- - - Ω	
MODE	Lim.		>φ<

2. Use the arrow keys **◀** or **▶** and select the position “>φ<”. The display shows the screen to the side.

RPE	15/10 – 18:04		
R	- - -	Ω	
I _{test}	- - -	mA	
STD	2.00Ω	- - - Ω	
MODE	Lim.		>φ<

3. Connect the measuring cables to each other as shown in Fig. 5.

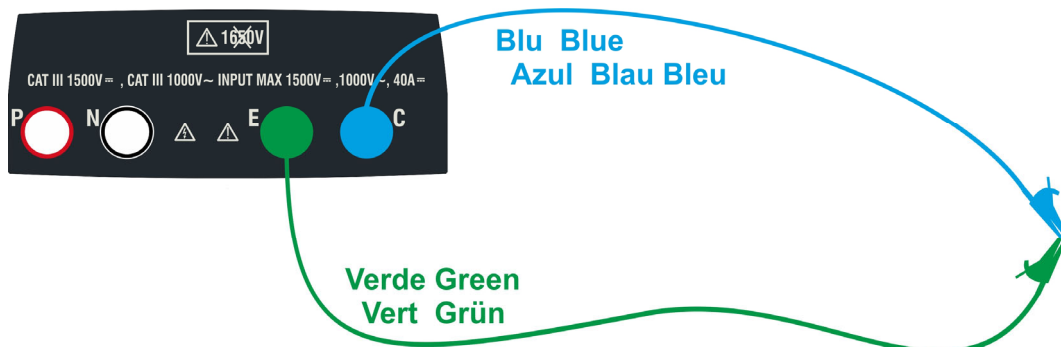



Fig. 5: Compensation of the measuring cables resistance

4. Use the arrow keys ◀ or ▶ and select the position “>ϕ<”.
The display shows the screen to the side.

RPE		15/10 – 18:04		
R	- - -	Ω		
I _{test}	- - -	mA		
STD	2.00Ω	- - - Ω		
MODE	Lim.		>ϕ<	

5. Press the **GO/STOP** key to start calibration. Messages “**Measuring...**” followed by “**Verification**” and “**Zeroing**” are shown in a sequence on the display.

RPE		15/10 – 18:04		
R	- - -	Ω		
I _{test}	- - -	mA		
Measuring...				
STD	2.00Ω	- - - Ω		
MODE	Lim.		>ϕ<	

6. At the end of the compensation procedure, in case the measured resistance value is $\leq 5\Omega$, the instrument emits a double tone to signal the positive result of the test and displays the value of the compensated resistance of the cables, which will be subtracted from all the subsequent continuity measurements, at the bottom on the right side of the display.

RPE		15/10 – 18:04		
R	- - -	Ω		
I _{test}	- - -	mA		
STD	2.00Ω	0.06 Ω		
MODE	Lim.		>ϕ<	

6.3.2. Carrying out continuity measurements in Standard (STD) mode

1. Position the cursor onto **RPE** by using the arrow keys (**▲**, **▼**) and confirm with **ENTER**. The display shows the following screen. The symbol “STD” is shown on the display.

RPE	15/10 – 18:04		
R	- - -	Ω	
I _{test}	- - -	mA	
STD	2.00Ω	- - - Ω	
MODE	Lim.		>φ<

2. Use the arrow keys **◀** or **▶** and select the position “**Lim.**”. The display shows the screen to the side.
3. Use the arrow keys (**▲**, **▼**) to set the limit reference threshold for continuity measurement, which can be selected in a range between **0.01Ω ÷ 9.99Ω** in steps of 0.01Ω (please remember that standard IEC/EN62446-1 does not establish a limit value for resistance and typical values are approx. 1Ω or 2Ω).

RPE	15/10 – 18:04		
R	- - -	Ω	
I _{test}	- - -	mA	
STD	2.00Ω	- - - Ω	
MODE	Lim.		>φ<

4. Carry out the initial calibration of the measuring cables (see § 6.3.1).
5. Connect the instrument to the PV module/string being tested and to the main earth node of the system as shown in Fig. 6.

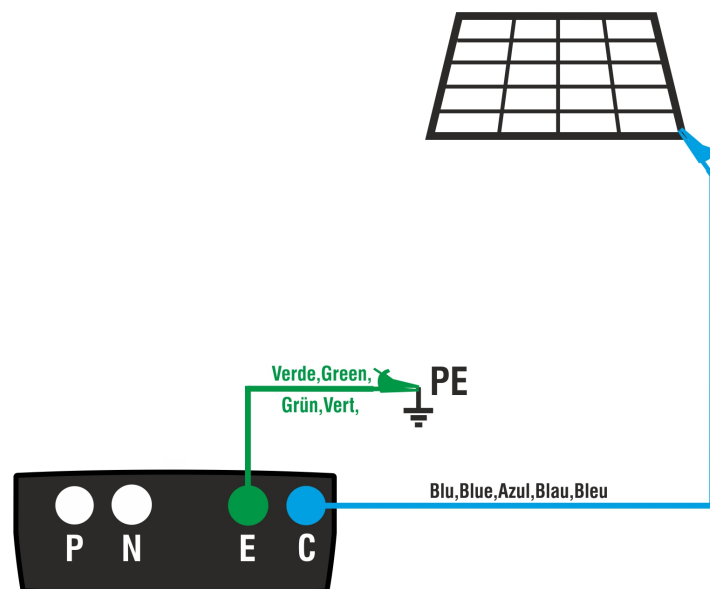



Fig. 6: Connection of instrument for continuity measurement on structures of the PV installation



CAUTION

Upon pressing the **GO/STOP** key, different error messages can be displayed by the instrument (§ 6.3.4) and, therefore, the test cannot be started. Check and eliminate, if possible, the problem causing the error message before going on with the test.

6. Press the **GO/STOP** key to start the test. In case no error conditions occur, the instrument displays the message “**Measuring...**” as shown in the screen to the side.

RPE	15/10 – 18:04		
R	- - -	Ω	
I _{test}	- - -	mA	
Measuring...			
STD	2.00 Ω	0.06 Ω	
MODE	Lim.		> ϕ <

7. At the end of measurement, the instrument provides the value of resistance of the object being tested. If the result is lower than the set maximum limit value, the instrument shows the message “**OK**” (value lower or equal to the set limit threshold), otherwise it displays the message “**NO OK**” (value higher than the set limit threshold) as shown in the screen to the side.

8. Press the **SAVE** key to store the test result in the instrument’s memory (see § 7.1) or the **ESC/MENU** key to exit the screen without saving and go back to the main measuring screen.

RPE	15/10 – 18:04		
R	0.23	Ω	
I _{test}	210	mA	
OK			
STD	2.00 Ω	0.06 Ω	
MODE	Lim.		> ϕ <

6.3.3. Carrying out continuity measurements in Timer (TMR) mode

- Position the cursor onto **RPE** by using the arrow keys (**▲**, **▼**) and confirm with **ENTER**. The display shows the following screen.
- Use the arrow keys (**▲**, **▼**) to select the Timer mode. The symbol “TMR” is shown on the display.

RPE	15/10 – 18:04		
R	- - -	Ω	
I _{test}	- - -	mA	
T	- - -	s	
TMR	2.00Ω	12s	- - - Ω
MODE	Lim.	Time	>φ<

- Use the arrow keys **◀** or **▶** and select the position “**Lim.**”. The display shows the screen to the side.
- Use the arrow keys (**▲**, **▼**) to set the limit reference threshold for continuity measurement, which can be selected in a range between **0.01Ω ÷ 9.99Ω** in steps of 0.01Ω (please remember that standard IEC/EN62446-1 does not establish a limit value for resistance and typical values are approx. 1Ω or 2Ω).

RPE	15/10 – 18:04		
R	- - -	Ω	
I _{test}	- - -	mA	
T	- - -	s	
TMR	2.00Ω	12s	- - - Ω
MODE	Lim.	Time	>φ<

- Use the arrow keys **◀** or **▶** and select the position “**Time**”. The display shows the screen to the side.
- Use the arrow keys (**▲**, **▼**) to set the **duration of continuity measurement (Timer)**, which can be selected in a range between **3s ÷ 99s in steps of 3s**.

RPE	15/10 – 18:04		
R	- - -	Ω	
I _{test}	- - -	mA	
T	- - -	s	
TMR	2.00Ω	12s	- - - Ω
MODE	Lim.	Time	>φ<

- Carry out the initial calibration of the measuring cables (see § 6.3.1).
- Connect the instrument to the PV module/string being tested and to the main earth node of the system as shown in Fig. 6.



CAUTION

Upon pressing the **GO/STOP** key, different error messages can be displayed by the instrument (§ 6.3.4) and, therefore, the test cannot be started. Check and eliminate, if possible, the problem causing the error message before going on with the test.

9. Press the **GO/STOP** key to start the test. In case no error conditions occur, the instrument starts a series of continuous measurements for the entire duration of the set Timer, **emitting a short sound every 3s**, and showing alternatively the messages “**Measuring...**” and “**Please wait...**” as shown in the screen to the side. In this way, the operator can move from one point to another of the place in which measurement is being carried out.

RPE	15/10 – 18:04		
R	0.23	Ω	
I _{test}	209	mA	
T	11	S	
Please wait...			
STD	2.00 Ω	12s	0.06 Ω
MODE	Lim.	Time	> ϕ <

10. At the end of measurement, the instrument provides the maximum value among all those of the partial measurements carried out. If the result is lower than the set maximum limit value, the instrument shows the message “**OK**” (value lower or equal to the set limit threshold), otherwise it displays the message “**NO OK**” (value higher than the set limit threshold) as shown in the screen to the side.

RPE	15/10 – 18:04		
R	0.54	Ω	
I _{test}	209	mA	
T	0	S	
OK			
STD	2.00 Ω	12s	0.06 Ω
MODE	Lim.	Time	> ϕ <

11. Press the **SAVE** key to store the test result in the instrument’s memory (see § 7.1) or the **ESC/MENU** key to exit the screen without saving and go back to the main measuring screen.

6.3.4. Anomalous situations

- To zero the value of compensated resistance, carry out a new compensation procedure with a resistance higher than 5Ω as, for example, with open leads. The message "Zero Reset" appears on the display.
- In case the instrument detects a voltage **higher than 3V** at its terminals E and C, it does not carry out the test, gives out a long sound and displays the message "V.Input > 3V".
- In case the instrument detects that the calibrated resistance is higher than the measured resistance, the instrument gives out a long sound and displays the message: "Zeroing NO OK"
- In case the instrument detects a resistance higher than 5Ω at its terminals, it gives out a long sound, zeroes the compensated value and displays the message "Zero Reset".
- In case it was detected that the calibrated resistance is higher than the measured resistance (for example because cables different from the provided ones were used), the instrument gives a long acoustic signal and displays a screen similar to the one to the side. Carry out a reset and make a new compensation of the cables.

RPE	15/10 – 18:04		
R	- - -	Ω	
I _{test}	- - -	mA	
Zero Reset			
STD	2.00 Ω	- - - Ω	
MODE	Lim.		> ϕ <
RPE	15/10 – 18:04		
R	- - -	Ω	
I _{test}	- - -	mA	
V.Input > 3V			
STD	2.00 Ω	- - - Ω	
MODE	Lim.		> ϕ <
RPE	15/10 – 18:04		
R	0.03	Ω	
I _{test}	212	mA	
Zeroing NO OK			
STD	2.00 Ω	0.220 Ω	
MODE	Lim.		> ϕ <
RPE	15/10 – 18:04		
R	>4.99	Ω	
I _{test}	49	mA	
Zero Reset			
STD	2.00 Ω	- - - Ω	
MODE	Lim.		> ϕ <
RPE	15/10 – 18:04		
R	- - -	Ω	
I _{test}	- - -	mA	
Rcal > Rmeas			
STD	2.00 Ω	- - - Ω	
MODE	Lim.		> ϕ <

6.4. MΩ – MEASUREMENT OF INSULATION ON PV MODULES/STRINGS/FIELDS

The purpose of this function is measuring the insulation resistance of the active conductors of PV modules, strings and fields according to the prescriptions of standards IEC/EN62446-1 and IEC/EN61557-2, **with no need to use an external switch to short-circuit the positive and negative terminals.**



CAUTION

- Insulation measurement can be performed on a single module, string or on an installation consisting in more strings connected in parallel.
- Separate the string/installation from the inverter and from possible overvoltage protections.
- If the module/string has a pole connected to earth, this connection must be temporarily interrupted.
- In compliance with standard IEC/EN62446-1, test voltage V_{test} must be \geq rated voltage of the installation.
- Standard IEC/EN61557-2 sets $1M\Omega$ as a minimum value of insulation resistance for installations with a rated voltage higher than 120V.
- We recommend measuring insulation directly on the module/string/field located upstream of possible blocking diodes.

The instrument measures insulation in the following modes:

- **DUAL** mode → the instrument measures insulation in a sequence between the positive pole (+) and the PE reference and between the negative pole (-) and the PE reference of PV modules, strings or fields, and calculates overall resistance R_p .
- **TMR** mode → the instrument measures continuously (with a max duration of 999s) between terminal “N” and the PE reference, displaying the minimum resistance value obtained at the end of the selected time. In this way, the instrument also calculates the DAR (Dielectric Absorption Ratio) and PI (Polarization Index) parameters, if the duration of the test is suitable for these parameters’ calculation.

6.4.1. Measuring insulation – DUAL mode

1. Position the cursor onto **MΩ** by using the arrow keys (▲, ▼) and confirm with **ENTER**. The display shows the screen to the side. By using the arrow keys (▲, ▼) again, select the “**DUAL**” measuring mode, in position “**MODE**”.

MΩ	15/10 – 18:04		
	(+)	(-)	
V _{test}	- - -	- - -	V
Riso	- - -	- - -	MΩ
	R _p	- - -	MΩ
	V _{PN}	V _{PE}	V _{NE}
	0V	0V	0V
DUAL	1500V	1.00MΩ	
MODE	V _{test.}	Lim.	

2. Use the arrow keys ◀ or ▶ and select the position “**V_{test}**” to set the test voltage.
3. Use the arrow keys (▲, ▼) to select one of the following test voltages (V_{nom}): **250, 500, 1000, 1500VDC**. Please remember that, in compliance with standard IEC/EN 62446-1, test voltage V_{test} must be \geq rated voltage of the installation.

MΩ	15/10 – 18:04		
	(+)	(-)	
V _{test}	- - -	- - -	V
Riso	- - -	- - -	MΩ
	R _p	- - -	MΩ
	V _{PN}	V _{PE}	V _{NE}
	0V	0V	0V
DUAL	1500V	1.00MΩ	
MODE	V _{test.}	Lim.	

4. Use the arrow keys ◀ or ▶ and select the position “Lim.”. The display shows the screen to the side.
5. Use the arrow keys (▲,▼) to set the **minimum** limit threshold for insulation measurement, which can be selected among the values **0.05, 0.10, 0.23, 0.25, 0.50, 1.00, 50MΩ**. Please remember that standard IEC/EN61557-2 sets 1MΩ as a minimum value of insulation resistance for installations with a rated voltage higher than 120V.

MΩ	15/10 – 18:04		
	(+)	(-)	
V _{test}	- - -	- - -	V
R _{iso}	- - -	- - -	MΩ
	R _p	- - -	MΩ
	V _{PN}	V _{PE}	V _{NE}
	0V	0V	0V
DUAL	1500V	1.00MΩ	
MODE	V _{test}	Lim.	

6. Connect the instrument to the PV string to be tested as shown in Fig. 7. **The test can be carried out also on more strings connected in parallel to each other. Please remember that it is also necessary to separate possible overvoltage protections connected to the cables of the string(s) and that it is recommended to measure upstream of possible blocking diodes.**

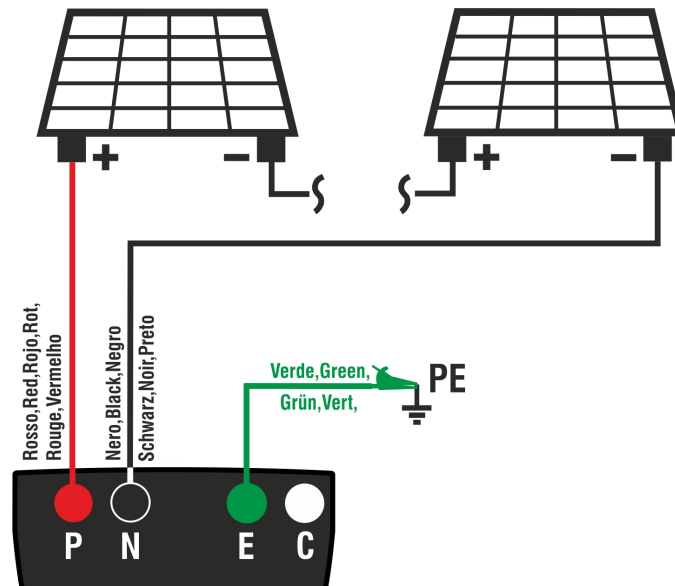

Fig. 7: Instrument connection for insulation measurement in DUAL mode

CAUTION

- Upon pressing the **GO/STOP** key, different error messages can be displayed by the instrument (§ 6.4.3) and, therefore, the test cannot be started. Check and eliminate, if possible, the problem causing the error message before going on with the test
- Do not touch the masses of the modules during the measurement as they could be at dangerous potential even with the system disconnected due to the voltage generated by the instrument
- The measurement could give incorrect results if the earth reference is not correctly connected to input **E**
- We recommend a preliminary check of correct functioning of the instrument before carrying out a measurement by short-circuiting terminals **P**, **N** and **E**, checking an insulation value of almost zero and an out-of-scale value with terminals **P**, **N** and **E** open



7. **Press and hold the GO/STOP key for at least 3s** in order to start the test. In case no error conditions occur, the instrument displays the message “**Measuring...**” as shown in the screen to the side. In field “Vtest”, the real test voltage generated by the instrument is shown. **Test duration may vary according to the presence of stray capacitances**

MΩ	15/10 – 18:04		■
	(+)	(-)	
Vtest	- - -	- - -	V
Riso	- - -	- - -	MΩ
	Rp	- - -	MΩ
	VPN	VPE	VNE
	1480V	750V	-748V
Measuring...			
DUAL	1500V	1.00MΩ	
MODE	Vtest.	Lim.	

8. The instrument carries out the following measurements in a sequence:

- Insulation between positive pole (+) of the string and earth connection
- Insulation between negative pole (-) of the string and earth connection
- Calculation of the value of resistance **Rp** given by the parallel of measurements (+) and (-)

If “**Rp**≥**Lim**”, the instrument shows the message “**OK**”, to indicate a **positive** result of measurement.

Press the **SAVE** key to store the test result in the instrument’s memory (see § 7.1) or the **ESC/MENU** key to exit the screen without saving and go back to the main measuring screen.

MΩ	15/10 – 18:04		■
	(+)	(-)	
Vtest	1510	1515	V
Riso	>100	>100	MΩ
	Rp	>100	MΩ
	VPN	VPE	VNE
	1480V	750V	-730V
OK			
DUAL	1500V	1.00MΩ	
MODE	Vtest.	Lim.	

6.4.2. Measuring insulation – TMR mode

1. Position the cursor onto **MΩ** by using the arrow keys (▲, ▼) and confirm with **ENTER**. The display shows the screen to the side. By using the arrow keys (▲, ▼) again, select the “**TMR**” measuring mode, in position “**MODE**”.

MΩ	15/10 – 18:04		■
Vtest(-)	- - -	- - -	V
Ri(-)	- - -	- - -	MΩ
Time	- - -	- - -	s
DAR	- - -	PI	- - -
	VPN	VPE	VNE
	0V	0V	0V
TMR	1500V	1.00MΩ	3s
MODE	Vtest.	Lim.	Time

2. Use the arrow keys ◀ or ▶ and select the position “**Vtest**” to set the test voltage.
3. Use the arrow keys (▲, ▼) to select one of the following test voltages (Vnom): **250, 500, 1000, 1500VDC**. Please remember that, in compliance with standard IEC/EN 62446-1, test voltage Vtest must be ≥ rated voltage of the installation.

MΩ	15/10 – 18:04		■
Vtest(-)	- - -	- - -	V
Ri(-)	- - -	- - -	MΩ
Time	- - -	- - -	s
DAR	- - -	PI	- - -
	VPN	VPE	VNE
	0V	0V	0V
TMR	1500V	1.00MΩ	3s
MODE	Vtest.	Lim.	Time

4. Use the arrow keys ◀ or ▶ and select the position “Lim.”. The display shows the screen to the side.
5. Use the arrow keys (▲,▼) to set the **minimum** limit threshold for insulation measurement, which can be selected among the values **0.05, 0.10, 0.23, 0.25, 0.50, 1.00, 50MΩ**. Please remember that standard IEC/EN62446-1 sets 1MΩ as a minimum value of insulation resistance for installations with a rated voltage higher than 120V.

MΩ	15/10 – 18:04		■
Vtest(-)	- - -	V	
Ri(-)	- - -	MΩ	
Time	- - -	s	
DAR	- - -	PI	- - -
	VPN	VPE	VNE
	0V	0V	0V
TMR	1500V	1.00MΩ	3s
MODE	Vtest.	Lim.	Time

6. Use the arrow keys ◀ or ▶ and select the position “Time”. The display shows the screen to the side.
7. Use the arrow keys (▲,▼) to set the measuring time in the range: **3s ÷ 999s**

MΩ	15/10 – 18:04		■
Vtest(-)	- - -	V	
Ri(-)	- - -	MΩ	
Time	- - -	s	
DAR	- - -	PI	- - -
	VPN	VPE	VNE
	0V	0V	0V
TMR	1500V	1.00MΩ	3s
MODE	Vtest.	Lim.	Time

8. Connect the instrument to the PV string to be tested as shown in Fig. 8. **The test can be carried out also on more strings connected in parallel to each other. Please remember that it is also necessary to separate possible overvoltage protections connected to the cables of the string(s) and that it is recommended to measure upstream of possible blocking diodes.**

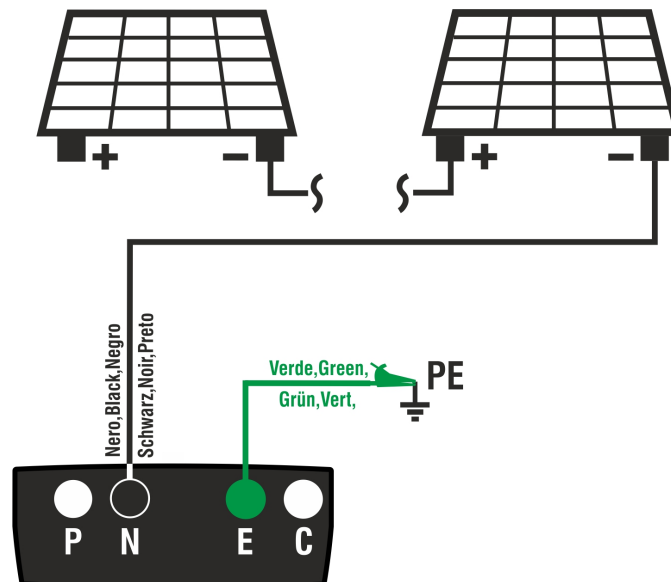

Fig. 8: Instrument connection for insulation measurement in TMR mode



CAUTION

Upon pressing the **GO/STOP** key, different error messages can be displayed by the instrument (§ 6.4.3) and, therefore, the test cannot be started. Check and eliminate, if possible, the problem causing the error message before going on with the test.

9. **Press and hold the GO/STOP key for at least 3s** in order to start the test. In case no error conditions occur, the instrument displays the message “**Measuring...**” as shown in the screen to the side. In field “Vtest (-)”, the real test voltage generated by the instrument is shown.

MΩ	15/10 – 18:04		■
Vtest(-)	- - -	V	
Ri(-)	- - -	MΩ	
Time	- - -	s	
DAR	- - -	PI	- - -
	VPN	VPE	VNE
	0V	0V	0V
Measuring...			
TMR	1500V	1.00MΩ	700s
MODE	Vtest.	Lim.	Time
MΩ	15/10 – 18:04		■
Vtest(-)	1540	V	
Ri(-)	>100	MΩ	
Time	600	s	
DAR	1.41	PI	1.02
	VPN	VPE	VNE
	0V	0V	0V
OK			
TMR	1500V	1.00MΩ	700s
MODE	Vtest.	Lim.	Time

10. If “**Ri(-)≥Lim**”, the instrument shows the message “**OK**” to indicate the **positive** result of measurement.

If the measuring time is $\geq 60s$, the instrument shows on the display the value of parameter **DAR** ((Dielectric Absorption Ratio) (see § 11.2).

If the measuring time is $\geq 600s$, the instrument shows on the display both the value of parameter **DAR** ((Dielectric Absorption Ratio) and the value of parameter **PI** (Polarization Index) (see § 11.1).

Press the **SAVE** key to store the test result in the instrument’s memory (see § 7.1) or the **ESC/MENU** key to exit the screen without saving and go back to the main measuring screen.

6.4.3. Anomalous situations

- In case the instrument detects one of the following conditions: “|VPN| > 1500V”, “|VPE| > 1500V” or “|VNE| > 1500V”, it stops measuring, gives out a long sound, and the message “**V > LIM**” appears on the display. Check the output voltage from the PV string.

MΩ	15/10 – 18:04		
	(+)	(-)	
Vtest	- - -	- - -	V
Ins.re	- - -	- - -	MΩ
	Rp	- - -	MΩ
	VPN	VPE	VNE
	> 1500V	750V	-750V
V > LIM			
DUAL	1500V	1.00MΩ	
MODE	Vtest.	Lim.	

- In DUAL mode, in case the instrument, upon pressing the **GO/STOP** key, detects a voltage **VPN < 0V**, it stops measuring, gives out a long sound and the message **Reverse P-N** appears on the display. Check polarity and the instrument's connections to the PV string.

MΩ	15/10 – 18:04		
	(+)	(-)	
Vtest	- - -	- - -	V
Ins.re	- - -	- - -	MΩ
	Rp	- - -	MΩ
	VPN	VPE	VNE
	-1480V	-750V	748V
Reverse P-N			
DUAL	1500V	1.00MΩ	
MODE	Vtest.	Lim.	

- In DUAL mode, in case the instrument, upon pressing the **GO/STOP** key, detects a voltage **VPN < 15V**, it stops measuring, gives out a long sound and the message “**VPN < 15VDC**” appears on the display. Check the output voltage from the PV string, which must be ≥30V.

MΩ	15/10 – 18:04		
	(+)	(-)	
Vtest	- - -	- - -	V
Ins.re	- - -	- - -	MΩ
	Rp	- - -	MΩ
	VPN	VPE	VNE
	10V	5V	-5V
VPN < 15VDC			
DUAL	1500V	1.00MΩ	
MODE	Vtest.	Lim.	

- In DUAL mode, in case the instrument, upon pressing the **GO/STOP** key, detects that one of the following conditions on measured voltages:

$$\text{RMS}(\text{VPN}) - |(\text{VPN}) \text{DC}| < 10$$

$$\text{RMS}(\text{VPE}) - |(\text{VPE}) \text{DC}| < 10$$

$$\text{RMS}(\text{VNE}) - |(\text{VNE}) \text{DC}| < 10$$

is not satisfied (**presence of AC components on input voltages**), it stops measuring, gives out a long sound and the message “**VAC > LIM**” is shown on the display. Check the output voltages from the PV string.

MΩ	15/10 – 18:04		
	(+)	(-)	
Vtest	- - -	- - -	V
Ins.re	- - -	- - -	MΩ
	Rp	- - -	MΩ
	VPN	VPE	VNE
	1480V	750V	-730V
VAC > LIM			
DUAL	1500V	1.00MΩ	
MODE	Vtest.	Lim.	

5. In case the instrument detects that the voltage between the positive and the negative pole is higher than the set test voltage, the message “**VPN>Vtest**” appears on the display and the instrument stops the test because it does not comply with standard IEC/EN62446-1. Check the rated voltage of the installation, change the parameter Vtest, if necessary, and repeat the test.

MΩ	15/10 – 18:04		
	(+)	(-)	
Vtest	1520	1510	V
Ins.re	- - -	- - -	MΩ
	Rp	- - -	MΩ
	VPN	VPE	VNE
	1480V	750V	-730V
VPN>Vtest			
DUAL	1500V	1.00MΩ	
MODE	Vtest.	Lim.	

6. In case the instrument detects that $R_p < Lim$, the message “**NOT OK**” is shown on the display.

MΩ	15/10 – 18:04		
	(+)	(-)	
Vtest	1540	1520	V
Ins.re	0.1	>100	MΩ
	Rp	0.1	MΩ
	VPN	VPE	VNE
	1480V	750V	-730V
NOT OK			
DUAL	1500V	1.00MΩ	
MODE	Vtest.	Lim.	

6.5. GFL – SEARCHING FOR CONDITIONS OF LOW INSULATION ON PV STRINGS

In GFL (Ground Fault Locator) function, the instrument can provide an indication about the position of a possible single fault of low insulation located in a string of the installation due, for example, to infiltrations of water or humidity in the junction boxes of PV modules. The instrument measures input voltages and, according to the unbalance between V(+) and V(-) with respect to earth, it detects the assumed position of the fault on the string.

CAUTION

The GFL function allows obtaining correct results **ONLY** with the following conditions:



- Test carried out **upstream of possible blocking diodes**, on a **single string** disconnected from the inverter, from possible overvoltage protections and from functional connections to earth.
- **Single fault** of low insulation located at any position in the string
- Insulation resistance of the single fault **<0.23MΩ**
- Given the random nature of these faults, **we recommend** carrying out measurements in environmental conditions similar to those in which the fault has been detected.

- Position the cursor onto **GFL** by using the arrow keys (**▲**, **▼**) and confirm with **ENTER**. The display shows the screen to the side. The indication “Rp” indicates the parallel of the insulation resistances of the positive (+) and negative (-) poles of the string being tested.

GFL		15/10 – 18:04		
Rp	- - -	MΩ		
VPN	VPE	VNE		
0V	0V	0V		
10	1500V	0.10MΩ		
NMOD	Vtest.	Lim.		

- Use the arrow keys **◀** or **▶** and select the position “**NMOD**” to set the number of modules of the string being tested.
- Use the arrow keys (**▲**, **▼**) to select a number of modules between: **4 ÷ 35**

GFL		15/10 – 18:04		
Rp	- - -	MΩ		
VPN	VPE	VNE		
0V	0V	0V		
10	1500V	0.10MΩ		
NMOD	Vtest.	Lim.		

- Use the arrow keys **◀** or **▶** and select the position “**Vtest**” to set the test voltage.
- Use the arrow keys (**▲**, **▼**) to select one of the following test voltages (Vnom): **250, 500, 1000, 1500VDC**. In compliance with IEC/EN62446-1, we recommend setting the test voltage of the installation **Vtest ≥ Vnom**

GFL		15/10 – 18:04		
Rp	- - -	MΩ		
VPN	VPE	VNE		
0V	0V	0V		
10	1500V	0.10MΩ		
NMOD	Vtest.	Lim.		

6. Use the arrow keys ◀ or ▶ and select the position “Lim.”. The display shows the screen to the side.
7. Use the arrow keys (▲,▼) to set the **minimum** limit threshold for insulation measurement, which can be selected among the following values: **0.05MΩ**, **0.1MΩ**, **0.23MΩ**

GFL		15/10 – 18:04			
Rp	- - -			MΩ	
VPN	0V	VPE	0V	VNE	0V
10	1500V	0.10MΩ			
NMOD	Vtest.	Lim.			

8. Connect the instrument to the PV string to be tested as shown in Fig. 9. Please remember that it is also necessary to separate possible overvoltage protections connected to the cables of the string, and that it is recommended to measure upstream of possible blocking diodes.

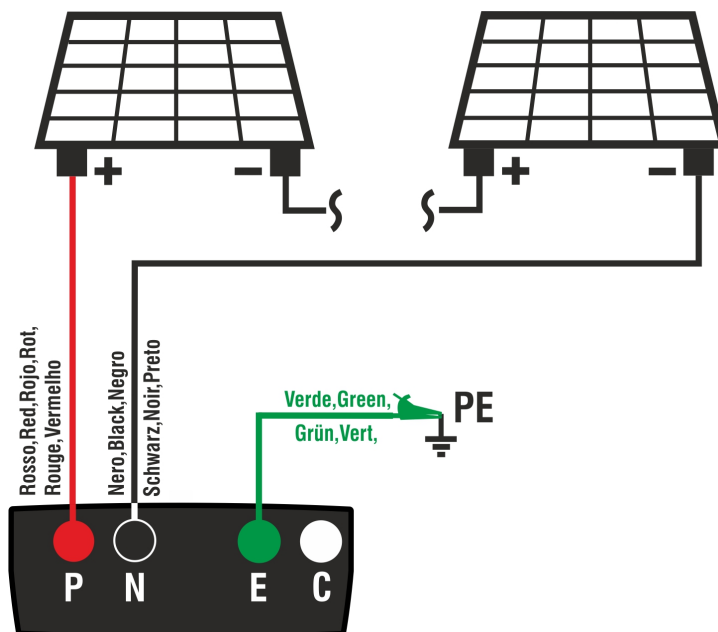

Fig. 9: Instrument connection for insulation measurement in GFL mode

CAUTION

- Upon pressing the **GO/STOP** key, different error messages can be displayed by the instrument (§ 6.4.3) and, therefore, the test cannot be started. Check and eliminate, if possible, the problem causing the error message before going on with the test
- Do not touch the masses of the modules during the measurement as they could be at dangerous potential even with the system disconnected due to the voltage generated by the instrument
- The measurement could give incorrect results if the earth reference is not correctly connected to input **E**
- We recommend a preliminary check of correct functioning of the instrument before carrying out a measurement by short-circuiting terminals **P**, **N** and **E**, checking an insulation value of almost zero and an out-of-scale value with terminals **P**, **N** and **E** open.



9. **Press and hold the GO/STOP key for at least 3s** in order to start the test. In case no error conditions occur, the instrument displays the message “**Measuring...**” as shown in the screen to the side.

GFL		15/10 – 18:04		
Rp	- - -	MΩ		
VPN	VPE	VNE		
0V	0V	0V		
Measuring...				
10	1500V	0.10MΩ		
NMOD	Vtest.	Lim.		

10. **With no fault conditions ($R_p \geq Lim$)**, the instrument shows the screen to the side and the message “**OK**” appears on the display.

GFL		15/10 – 18:04		
Rp	> 100	MΩ		
VPN	VPE	VNE		
1480V	750V	-730V		
OK				
14	1500V	0.10MΩ		
NMOD	Vtest.	Lim.		

11. **In case a fault is present ($R_p < Lim$) in position 0 (upstream of the first module)**, the instrument shows the screen to the side and the message “**GND: Fault (+)..1**” on the display. Check the condition of the insulation of the conductor (+) which comes from the string.

GFL		15/10 – 18:04		
Rp	0.0	MΩ		
VPN	VPE	VNE		
1480V	750V	-730V		
GND: Fault (+)..1				
14	1500V	0.10MΩ		
NMOD	Vtest.	Lim.		

12. **In case a fault is present ($R_p < Lim$) in position NMOD+1 (downstream of the last module)**, the instrument shows the screen to the side and the message “**GND: Fault NMOD..(-)**” on the display. Check the condition of the insulation of the conductor (-) which comes from the string.

GFL		15/10 – 18:04		
Rp	0.0	MΩ		
VPN	VPE	VNE		
1480V	750V	-730V		
GND: 14.. (-)				
14	1500V	0.10MΩ		
NMOD	Vtest.	Lim.		

13. **In case a fault is present ($R_p < Lim$) in position 1 (between module 1 and 2)**, the instrument shows the screen to the side and the message “**GND: Fault 1..2**” on the display. Check the condition of the insulation of the junction boxes of the indicated modules (1 and 2, in the example) and the relevant connection cables.

GFL		15/10 – 18:04		
Rp	0.0	MΩ		
VPN	VPE	VNE		
1480V	750V	-730V		
GND: Fault 1..2				
14	1500V	0.10MΩ		
NMOD	Vtest.	Lim.		

14. **In case a fault is present ($R_p < \text{Lim}$) in position NMOD (between the second last and the last module),** the instrument shows the screen to the side and the message “**GND: Fault NMOD-1..NMOD**” on the display.

Check the condition of the insulation of the junction boxes of the indicated modules and the relevant connection cables.

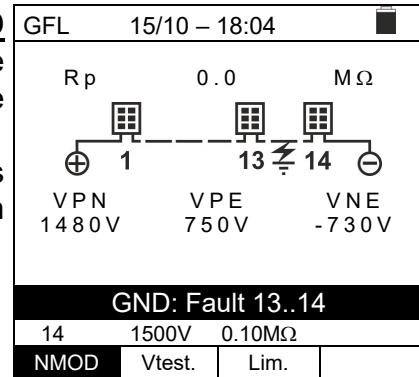

15. In case a fault is present ($R_p < \text{Lim}$) within the string, the instrument shows the screen to the side and the message (relevant to the example with NMOD = 14) “**GND: Fault 8..9**” on the display. Check the condition of the insulation of the junction boxes of the indicated modules and the relevant connection cables.

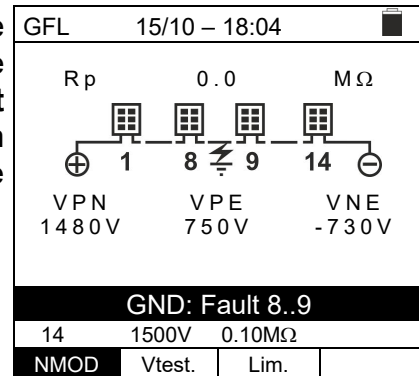

CAUTION

The results of function GFL cannot be saved in the instrument's memory.

6.6. DB – MODULE DATABASE MANAGEMENT

The instrument allows managing **up to a maximum of 64 PV modules**, further to a DEFAULT module (not editable and not erasable) which can be used as reference case when no information about the type of module being tested is available.

The parameters, **referred to 1 module**, which can be set in the definition are reported in the following Table 1 together with the measuring ranges, resolution and validity conditions:

Item	Description	Range	Resolution	Notes
Prod	Manufacturer's name of module	Max 15 digits		Only CAPITAL
Name	Module name	Max 15 digits		Only CAPITAL
Type	Type of module	Monofacial Bifacial		
Voc	Open-circuit voltage	15.00 ÷ 199.99V	0.01V	Voc ≥ Vmpp
Isc	Short-circuit current	0.50 ÷ 40.00A	0.01A	Isc ≥ Impp
Vmpp	Voltage on maximum power point	15.00 ÷ 199.99V	0.01V	Voc ≥ Vmpp
Impp	Current on maximum power point	0.50 ÷ 40.00A	0.01A	Isc ≥ Impp
Tmp.Isc (α)	Isc temperature coefficient	-0.100÷0.100 %/°C	0.001%/°C	100*α/ Isc ≤ 0.1
Tmp.Isc (β)	Voc temperature coefficient	-0.999÷-0.001 %/°C	0.001%/°C	100*β/Voc ≤ 0.999
Coef. Bif.	Coefficient of bifaciality (Bifacial modules only)	0.0 ÷ 100.0%	0.1%	

Table 1: Parameters associated to a PV module

6.6.1. How to define a new PV module

- Position the cursor onto **DB** by using the arrow keys (**▲**, **▼**) and confirm with **ENTER**. The display shows the screen which contains the type of module selected and the values of the parameters associated to the module

DB		15/10 – 18:04	
Man.	◀	SENEC	▶
Name:	◀	M 4 2 0	▶
Type	:	Bifacial	
Voc	:	38.00 V	
Isc	:	13.99 A	
Tmp.Isc(α)	:	0,046 %/°C	
Tmp.Voc(β)	:	-0,260 %/°C	
Bif.Coef.	:	90.0 %	
37/64			
New		Edit	Delete Free

- Use the arrow keys (**◀**, **▶**) to select the manufacturer of the module (field "**Man.**") and the name of the module (field "**Name**"). Choose by scrolling down the lists of those previously defined and saved.

DB		15/10 – 18:04	
Prod.	◀	SENEC	▶
Name:	◀	M 4 2 0	▶
Type	:	Bifacial	
Voc	:	38.00 V	
Isc	:	13.99 A	
Tmp.Isc(α)	:	0,046 %/°C	
Tmp.Voc(β)	:	-0,260 %/°C	
Bif.Coef.	:	90.0 %	
37/64			
New		Edit	Delete Free

4. Press “**New**” (which allows defining a new module) and confirm with **ENTER**. Use the arrow keys of the virtual keyboard to define a name for the module’s manufacturer. Confirm with “**OK**”

SAVE	15/10 – 18:04	
Manufacturer Name		
SUNPOWER_		
0 1 2 3 4 5 6 7 8 9 0 () % Q W E R T Y U I O P <=> # A S D F G H J K L + - * / & Z X C V B N M . , ; : ! ? _ Ä Ö Ü ß µ Ñ Ç Á Í Ó Ú Û Ü ÿ ÿ Á Ê Ë Ì Õ Ç Ä Æ Ï Ö Ù Æ Ø Å		
DEL OK NEW		

5. Use the arrow keys of the virtual keyboard to define a name for the module. Confirm with “**OK**”

SAVE	15/10 – 18:04	
Module name		
318WTH_		
0 1 2 3 4 5 6 7 8 9 0 () % Q W E R T Y U I O P <=> # A S D F G H J K L + - * / & Z X C V B N M . , ; : ! ? _ Ä Ö Ü ß µ Ñ Ç Á Í Ó Ú Û Ü ÿ ÿ Á Ê Ë Ì Õ Ç Ä Æ Ï Ö Ù Æ Ø Å		
DEL OK NEW		

3. Enter the value of each parameter (see Table 1) according to the manufacturer’s data sheet. Position the cursor onto the parameter to be defined by using the arrow keys (▲, ▼) and set the value using the arrow keys (◀, ▶). Keep the arrow keys (◀, ▶) pressed to carry out a quick setting of the values.

4. Press the **SAVE** key to save the settings or the **ESC/MENU** key to exit without saving.

DB	15/10 – 18:04	
Man.	SUNPOWER	
Name:	318WTH	
Type	: ◀	Monofacial ▶
Voc	: ◀	64.70 ▶V
Isc	: ◀	6.20 ▶A
Vmpp	: ◀	58.40 ▶V
Imp	: ◀	5.42 ▶A
Temp.Isc(α)	: ◀	0,057 ▶%/°C
Temp.Voc(β)	: ◀	-0,127 ▶%/°C

CAUTION



- If the value of any parameter is unknown, press and hold the **HELP** key for a few seconds to set the default value.
- Upon pressing the **SAVE** key, the instrument checks the conditions indicated in Table 1 and, if one or more of these conditions are not fulfilled, one of the error messages listed in § 6.8 is shown on the display. The instrument does not save the configuration set before any error is solved.

6.6.2. How to modify an existing PV module

1. Select the PV module to be modified from the database by means of the arrow keys (◀, ▶).
2. Press the **ENTER** key and select the “**Edit**” command using the arrow key (▼).
3. Confirm selection with **ENTER**.
4. By using the internal virtual keyboard, it is possible to define again the name of the module or leave it unchanged by means of the arrow keys ▲, ▼, ◀, ▶). Press **ENTER** to digit any character of the desired name.
5. Press the **SAVE** key to save the name of the new module thus defined or to access the new parameter setting.

DB		15/10 – 18:04	
Man.	◀	SENEC	▶
Name:	◀	M 4 2 0	▶
Type	:	Bifacial	
Voc	:	38.00	V
Isc	:	13.99	A
Temp.Isc(α)	:	0,046	%/°C
Temp.Voc(β)	:	-0,260	%/°C
Bif.Coef.	:	90.0	%
			37/64
New		Edit	Delete Free

6.6.3. How to delete an existing PV module

1. Select the PV module from the database by means of the arrow keys (◀, ▶).
2. Press the **ENTER** key and select the “**Delete**” command by means of the arrow key (▼) to delete the selected module.
3. Confirm the selection with **ENTER** or press **ESC/MENU** to exit.
4. The position “**Free**” indicates the residual number of modules which can still be entered into the database with reference to maximum allowed number (**64 modules**)

DB		15/10 – 18:04	
Prod.	◀	SENEC	▶
Name:	◀	M 4 2 0	▶
Type	:	Bifacial	
Voc	:	38.00	V
Isc	:	13.99	A
Temp.Isc(α)	:	0,046	%/°C
Temp.Voc(β)	:	-0,260	%/°C
Bif.Coef.	:	90.0	%
			37/64
New	Edit	Delete	Free



CAUTION

It is not possible to modify nor delete the “**DEFAULT**” PV module which is a factory setting.

6.7. IVCK - TEST ON PV MODULES AND STRINGS

6.7.1. Foreword

This function carries out a series of tests on a PV module/string, measuring in a sequence:

- **Open-circuit voltage Voc** of the PV string/module being tested, measured in **OPC** condition (**OPerative Condition**), i.e. in the real conditions in which the installation is, with or without irradiance and temperature measurement.
- **Open-circuit voltage Isc** of the PV string/module being tested, in compliance with standard IEC/EN62446, measured in **OPC** condition (**OPerative Condition**), i.e. in the real conditions in which the installation is, with or without irradiance and temperature measurement.
- **Insulation resistance in DUAL mode**, with measurement of values R(+), R(-) and Rp.
- **Continuity of protective conductors with 200mA**

When measuring Voc and Isc **WITHOUT measuring irradiance and temperature**, the instrument only displays OPC values, compares them to **average values** (rolling average of the last 10 measurements) and displays the result for a comparison with average values.

When measuring Voc and Isc **ALSO measuring irradiance and temperature**, the instrument automatically “converts” the data in OPC conditions to **STC** conditions (**Standard Test Condition** – Irradiance = 1000W/m², Module temperature = 25°C, spectrum distribution AM=1.5) for a comparison to the characteristics declared by the module’s manufacturer. **In these conditions, the use of the remote unit SOLAR03, to which irradiance and temperature test leads are connected, becomes necessary.**

Irradiance and temperature measurements of modules are carried out through one or more reference cells **HT305 (in case of Bifacial modules)** and with temperature probe **PT305**, connected to the remote unit **SOLAR03**, which communicates data in real time to the instrument **via Bluetooth connection**. In case the connection between instrument and remote unit becomes difficult (too high distance or transmission through walls/obstacles), it is possible to carry out measurements converted to STC conditions by **recording** the irradiance/temperature values from unit SOLAR03.

The recommended minimum irradiance threshold is **700W/m²** → the instrument carries out all tests included in I-V test, manages all conditions and error messages of I-V test (wrong numb. of mod., temp. out of range, cell presence, min. irr., etc.) and calculates the STC values of Voc and Isc. This mode is recommended whenever accurate tests are to be carried out on modules/strings being examined.

In general, the result page will include:

- Description of the module used
- Irradiance and temperature values (if available)
- Average values of Voc and Isc calculated as average of the corresponding values under OPC on the last 10 tests saved in the memory. If the number of tests is < 10, the average is calculated on the number of available tests. The first test will display dashes in the field “average values” as there are no previous tests on which to calculate an average.
- The values of Voc and Isc measured under OPC as well as any partial result (only available if STC values are not available) obtained by comparison with average values.
- The values of Voc and Isc calculated under STC (if available) and any partial result obtained by comparing the values calculated under STC with the nominal ones (inserted in DB modules)
- The overall test outcome (OK(NO)). The overall test outcome will be calculated basing on the partial outcomes in STC (if available) or basing on the partial outcomes in OPC (if STC values are not available).
- The instrument will not display any overall outcome if no partial outcome is available.

6.7.2. Carrying out IVCK Tests without remote unit



CAUTION

- Check that no remote unit SOLAR03 is currently activated. Otherwise, select “**Unpair**” to unpair the current active remote unit (see § 6.2).
- The maximum voltage between inputs P, N, E and C is 1500VDC. Do not measure voltages exceeding the limits given in this manual.
- Do not perform test on PV modules/strings connected to DC/AC converter
- Standard IEC/EN62446 requires that measurements are performed string by string. Even if the instrument is designed to manage inrush current for single strings or strings connected in parallel, we **recommend testing one string at a time** according to the standard’s prescriptions.

- Position the cursor onto **IVCK** by using the arrow keys (**▲**, **▼**) and confirm with **ENTER**. The display shows the screen to the side: The message “**Remote U. not active**” indicates that no remote unit SOLAR03 is connected to the instrument (see § 6.2). The following parameters are shown:

IVCK		15/10 – 18:04	
Remote U. not active			
V PN	V PE	V NE	
0V	0V	0V	
1000V	1.00MΩ	2Ω	
VTest	ISO	RPE	>φ<

- **VTest** → test voltage for insulation measurement
- **ISO** → minimum limit for insulation measurement
- **RPE** → maximum limit for continuity test
- **>φ<** → calibration resistance of cables for RPE test
- Values of voltages VPN, VPE and VNE

- Use the arrow keys (**▲**, **▼**) to access the setting of measurement parameters. The screen on the side appears on the display. Use the arrow keys (**◀**, **▶**) to set the values. The following options are available:

IVCK		15/10 – 18:04	
N.Mod. x STR	: ◀	01	▶
N.Str.in par.	: ◀	01	▶
Tol. Voc	: ◀	05	▶ %
Tol.Isc	: ◀	10	▶ %
Iso V.Test	: ◀	1000	▶ V
Iso R.Lim	: ◀	1.00	▶ MΩ
RPE lim	: ◀	2	▶ Ω
AVG Values	:	RESET	
AVG Voc	:	---	V
AVG Isc	:	---	A

- **N. Mod x STR** → set the number of modules of the string in range: **1 ÷ 35**
- **N. Str in par.** → Set the number of strings connected in parallel in range: **1 ÷ 10**
- **Tol. Voc** → set percentage tolerance for Voc measurement in range: **1% ÷ 15% (typical 5%)**
- **Tol. Isc** → set percentage tolerance for Isc measurement in range: **1% ÷ 15% (typical 10%)**
- **Iso V. Test** → set test voltage for insulation measurement among the options: **OFF (measurement excluded), 250V, 500V, 1000V, 1500VDC**
- **Iso R.Lim** → set the minimum reference threshold for insulation measurement among the values: **0.05,0.10,0.23,0.25,0.50,1.00,50MΩ**
- **RPE Lim** → set the maximum limit for continuity test among the values: **OFF (measurement excluded), 1,2,3,4,5Ω**
- **AVG values** → the function “**RESET**” allows zeroing the average values of Voc and Isc parameters before starting a new measurement.
- **AVG Voc, AVG Isc** → average Voc and Isc values in the 10 previously saved tests.

- Press the **SAVE** key to save settings.

4. If necessary, select option “> ϕ <” and confirm with **ENTER**. Carry out this operation as indicated in § 6.3.1.
5. Connect the instrument to the PV module/string being tested and to the main earth node of the system, and to the metal masses connected to earth as shown in Fig. 10. In particular, connect the negative output pole of the PV module/string to terminal N and the positive output pole of the PV module/string to terminal P.

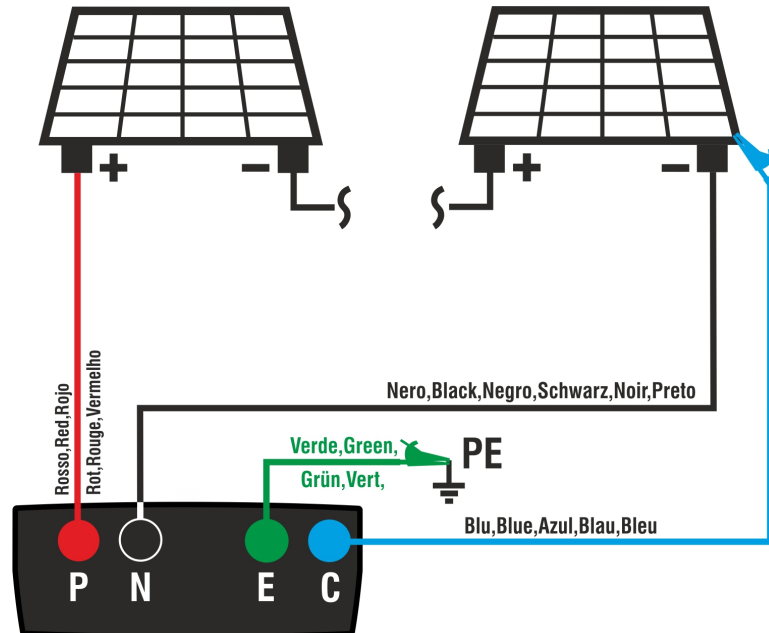

Fig. 10: Connection for IVCK tests without remote unit

WARNING



Upon pressing the **GO/STOP** key, different error messages can be displayed by the instrument (§ 6.8) and, therefore, the test cannot be started. Check and eliminate, if possible, the problem causing the error message before going on with the test.

6. Press the **GO/STOP** key to start the test. In case no error conditions occur, the instrument displays the message “**Measuring...**” and the measure of open-circuit voltage between terminals P and N and of short-circuit current (for Isc values $\leq 40A$).

IVCK			
15/10 – 18:04			
Voc@OPC	1485	V	
Isc@OPC	11.25	A	
Avg Voc	1485	V	
Avg Isc	11.25	A	
Rp	>100	M Ω	
R+	>100	R- >100	M Ω
RPE	---	Ω	
Measuring...			
1500V	1.00M Ω	2 Ω	--- Ω
VTest	ISO	RPE	> ϕ <

7. When Voc and Isc measurements are complete, the message “OK” is shown in case the result of the test is positive (**measured values within the tolerance values set on the instrument**).
8. With insulation measurement selected, the instrument goes on with the test, keeping terminals P and N short-circuited, and carrying out the test between this point and terminal E for the time necessary to obtain a steady value. The value of insulation resistance is shown in field “Rp” (parallel resistance between values R+ and R-) and the message “OK” appears in case the result of the test is positive (**measured value higher than the minimum limit value set on the instrument**).
9. With continuity measurement selected, the instrument goes on by opening the short-circuit and carrying out the test between terminals E and C. The value of resistance in the continuity test is shown in field “RPE” and the message “OK” appears in case the result of the test is positive (**measured value lower than the maximum limit value set on the instrument**).
10. The message “**Result OK**” is finally shown by the instrument in case the result of all performed tests is positive.

IVCK		15/10 – 18:04		
Voc@OPC	1485	V		OK
Isc@OPC	11.25	A		OK
Avg Voc	1485	V		OK
Avg Isc	11.25	A		OK
Rp	>100	MΩ		OK
R+	>100	R-	>100	MΩ
RPE	1.1	Ω		OK
Result: OK				
1500V	1.00MΩ	2Ω		0.2 Ω
VTest	ISO	RPE		>φ<

In general, the result of a test on a Voc and Isc measurement is determined by the following relationships:

Please note the following parameters:

Voc^{Avg} = average of open voltage calculated over last 10 measurements saved

Isc^{Avg} = average of short-circuit current calculated over last 10 measurements saved

$VocTol^+$ = positive tolerance value on Voc = $VocTol_{\%}^+ \times Voc^{Avg}$

$VocTol^-$ = negative tolerance value on Voc = $VocTol_{\%}^- \times Voc^{Avg}$

$IscTol^+$ = positive tolerance value on Isc = $IscTol_{\%}^+ \times Isc^{Avg}$

$IscTol^-$ = negative tolerance value on Isc = $IscTol_{\%}^- \times Isc^{Avg}$

$\varepsilon_{Voc}^{Meter}$ = maximum instrument error declared on Voc (see § 0)

$\varepsilon_{Isc}^{Meter}$ = maximum instrument error declared on Isc (see § 0)

$\varepsilon_{Voc}^{Meas} = Voc^{OPC} - Voc^{Avg}$ = error on Voc measurement @ OPC

$\varepsilon_{Isc}^{Meas} = Isc^{OPC} - Isc^{Avg}$ = error on Isc measurement @ OPC

The following conditions on parameters on the measurement result are managed by the instrument:

N	CONDITION	RESULT
1	$-VocTol^- + \epsilon_{Voc}^{Meter} \leq \epsilon_{Voc}^{Meas} \leq VocTol^+ - \epsilon_{Voc}^{Meter}$ $-IscTol^- - \epsilon_{Isc}^{Meter} \leq \epsilon_{Isc}^{Meas} \leq IscTol^+ + \epsilon_{Isc}^{Meter}$ (If ISO measurement selected) $R_p \geq R_p \text{ Lim}$ (If RPE measurement selected) $RPEmis \leq RPELim$	OK
2	Previous condition (1) is not verified, but the following one is valid: $-VocTol^- \leq \epsilon_{Voc}^{Meas} \leq VocTol^+$ $-IscTol^- \leq \epsilon_{Isc}^{Meas} \leq IscTol^+$ (If ISO measurement selected) $R_p \geq R_p \text{ Lim}$ (If RPE measurement selected) $RPEmis \leq RPELim$	OK*
3	Previous conditions (1) and (2) are not verified, but the following one is valid: $-VocTol^- - \epsilon_{Voc}^{Meter} \leq \epsilon_{Voc}^{Meas} \leq VocTol^+ + \epsilon_{Voc}^{Meter}$ $-IscTol^- - \epsilon_{Isc}^{Meter} \leq \epsilon_{Isc}^{Meas} \leq IscTol^+ + \epsilon_{Isc}^{Meter}$ (If ISO measurement selected) $R_p \geq R_p \text{ Lim}$ (If RPE measurement selected) $RPEmis \leq RPELim$	NO OK*
4	Previous conditions (1), (2) and (3) are not verified	NO OK

11. Press the **SAVE** key to store the test result in the instrument's memory (see § 7.1) or the **ESC/MENU** key to exit the screen without saving and go back to the main measuring screen.



CAUTION

- The average values of Voc and Isc are displayed in the results page. These values include the **average values of Voc and Isc under OPC conditions calculated as a rolling average of the last 10 tests previously saved**. If the user has carried out and saved a number of tests <10 or reset the average values, the average value displayed during test N+1 will be calculated on the available N values.
- When using the instrument like this, the average values previously calculated are particularly important. In case a new measurement campaign is started with significant variations in irradiance or temperature, **it is advisable to set the average reference values ("RESET") to zero** to make new calculations based on new measurements. Average values are anyway zeroed in case the user changes the number of modules and/or strings.

6.7.3. Carrying out IVCK Tests with remote unit

Irradiance and temperature measurements (if the instrument is set in temperature measuring mode “MEAS”) **with the aid of a remote unit SOLAR03 connected via Bluetooth to the instrument** are recommended in case of unstable irradiance conditions or if a comparison is necessary with the module’s rated values declared by the manufacturer.



CAUTION

- Check that no remote unit is currently activated. In case it is not, please carry out the connecting procedure described in § 6.2.
- The maximum voltage between inputs P, N, E and C is 1500VDC. Do not measure voltages exceeding the limits given in this manual.
- Do not perform tests on PV modules or strings connected to the DC/AC converter.
- **The maximum temperature which can be tolerated by the instrument is 40°C**
- Standard IEC/EN62446 requires that measurements are performed string by string. Even if the instrument is designed to manage inrush current for single strings or strings connected in parallel, we **recommend testing one string at a time** according to the standard’s prescriptions.

The instrument can operate combined with remote unit SOLAR03 in one of the following modes:

- **Presence of remote unit SOLAR03 active and connected** → the instrument directly provides the results of measurements @STC
- **Presence of remote unit SOLAR03 active, connected and recording:** the instrument directly provides the results of measurements @STC

Modes 1 and 2 are basically the same in case the instrument and the remote unit SOLAR03 are directly connected.

- **Presence of remote unit SOLAR03 active, recording, NOT connected** → the instrument provides the results of measurements @OPC with no outcome, then automatically and simultaneously converts them to @STC **only after data have been transferred from the remote unit at the end of recording and upon the next connection.**

SOLAR03 active and connected or active and recording

- Connect the instrument to the PV module/string being tested and to the main earth node of the system, and to the metal masses connected to earth as shown in Fig. 11. In detail:
 - Connect the negative output pole of the PV module/string to terminal **N** and the positive output pole of the PV module/string to terminal **P**.
 - **In case of Monofacial modules** → position the reference cell **HT305** onto the front surface of module (**F**) and at input “**INP1**” and **possibly** temperature probe **PT305** at input “**INP4**” of the remote unit.
 - **In case of Bifacial modules** → position the **3 reference cells HT305** onto the front surface of module (**F**), onto the back top part (**BH=BackHigh**) and onto the back bottom part (**BL=BackLow**) of the module. Connect the front reference cell (F) to input “**INP1**”, BH reference cell to input “**INP2**”, BL reference cell to input “**INP3**” and **possibly** the temperature probe **PT305** to input “**INP4**” of the remote unit.
 - Check reading of irradiance and temperature values on the remote unit SOLAR03.
- If necessary, select option “>φ<” and confirm with **ENTER**. Carry out a possible calibration of cables as described in § 6.3.1.

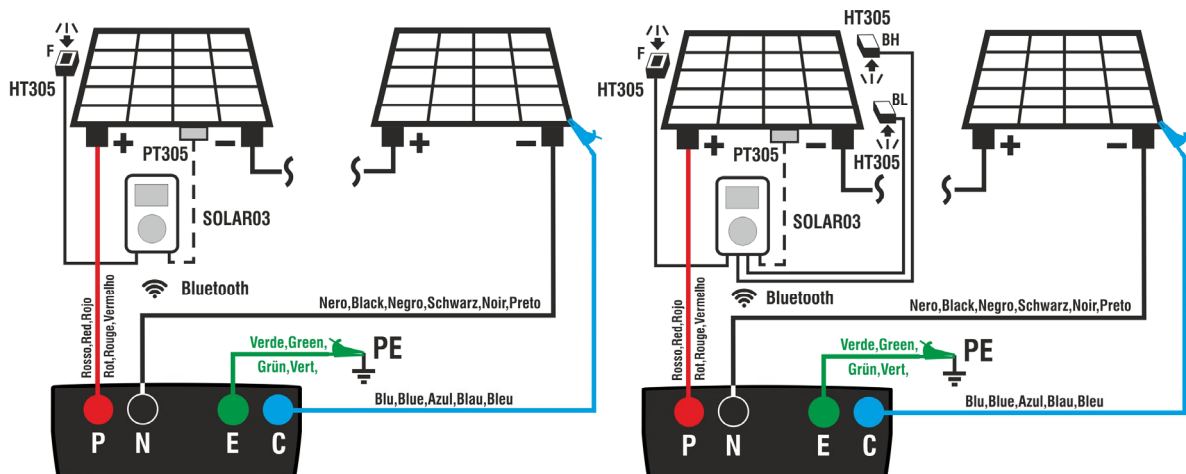

Fig. 11: Connection with remote unit SOLAR03 on Monofacial and Bifacial modules

- Position the cursor onto **IVCK** by using the arrow keys (▲, ▼) and confirm with **ENTER**. The display shows the screen to the side: The following parameters are shown:
 - **Irr.** → Irradiance values measured by cell HT305 connected to the remote unit
 - **Temp.** → Temperature value of module
 - **Remote unit** → indications on the serial number, connection status “**☑**” and possible ongoing recording “**∞**” of the remote unit SOLAR03 connected and active.
 - **ISO** → minimum limit for insulation measurement
 - **RPE** → maximum limit for continuity test
 - **>φ<** → value of calibration resistance of cables for continuity test
 - Values of voltages **VPN**, **VPE** and **VNE**

IVCK	15/10 – 18:04		
Front			
Irr.	920	W/m ²	
Temp.	54.7	°C	
SOLAR03	23051203		
Module: SUNPOWER318WTH			
VPN	VPE	VNE	
1480V	740V	-740V	
1000V	1.00MΩ	2Ω	0.25Ω
VTest	ISO	RPE	>φ<

4. Use the arrow keys (▲,▼) to access the setting of measurement parameters. The screen on the side appears on the display. Use the arrow keys (◀, ▶) to set the values. The following options are available:

- **Man.** → Set the manufacturer's name of the module (max 50) found in the internal DB
- **Name** → Set the name of the module (max 50) found in the internal DB. If, when entered in the database, the modules has been defined as "**Bifacial**", the instrument and the remote unit will automatically read 3 irradiance values.
- **N. Mod x STR** → set the number of modules of the string in range: **1 ÷ 35**
- **N. Str in par.** → Set the number of strings connected in parallel in range: **1 ÷ 10**
- **Mod. Temp** → set the measuring mode of module temperature by choosing among the options:
 - **AUTO** → temperature calculated by the instrument based on the measured Voc (no probe connected) – **recommended option**
 - **MEAS** → temperature measured via probe PT305 connected to remote unit
 - **MAN** → manual setting of module temperature if known in the subsequent range
- **Tol. Voc** → set percentage tolerance for Voc measurement in range: **1% ÷ 15% (typical 5%)**
- **Tol. Isc** → set percentage tolerance for Isc measurement in range: **1% ÷ 15% (typical 10%)**
- **Iso V. Test** → set test voltage for insulation measurement among the options: **OFF (measurement excluded), 250V, 500V, 1000V, 1500VDC**
- **Iso R.Lim** → set the minimum reference threshold for insulation measurement among the values: **0.05,0.10,0.23,0.25,0.50,1.00,50MΩ**
- **RPE Lim** → set the maximum limit for continuity test among the values: **OFF (measurement excluded), 1,2,3,4,5Ω**

IVCK		15/10 – 18:04	
Man.	◀	SUNPOWER	▶
Name:	◀	318WTH	▶
N.Mod. x STR	:	◀ 01	▶
N.Str.in par.	:	◀ 02	▶
Mod. Temp	:	◀ MAN	▶
		◀ 55	▶ °C
Tol. Voc	:	◀ 05	▶ %
Tol.Isc	:	◀ 10	▶ %
Iso V.Test	:	◀ 1000	▶ V
Iso R.Lim	:	◀ 1.00	▶ MΩ
RPE lim	:	◀ 2	▶ Ω

5. Press the **SAVE** key to save settings and go back to the previous screen.

6. Assemble the stem onto the disk of the optional accessory **M304** and keep it resting on the module's surface. **Check that the shadow of the stem on the disk falls within the internal "limit concentric circle" of the disk itself (see picture)**. Otherwise, the angle between the sun strays and the module's surface is too big and, therefore, the measurements carried out by the instrument are NOT to be trusted. **Repeat the operations at other times of the day.**

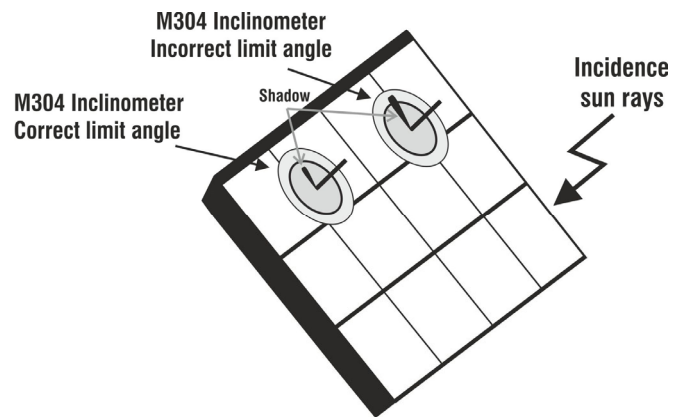

In case it is necessary to record of irradiance values over time (e.g. in unstable irradiance conditions or in case the distance between the modules and the instrument is high), follow the steps from 7 to 9, or jump to step 10.

7. Select option **UREM** from the main menu, pair and connect the remote unit SOLAR03 to the instrument as shown in step 6 of § 6.2

8. Use the arrow keys ◀ or ▶ to select "**Start**" to start the instrument's recording (**with non-modifiable 1s scan**) with the remote unit. The screen on the side appears on the display. In this condition, the instrument sends its system date / time to the remote unit SOLAR03, which is thus **synchronized** with it. The symbol "∞" appears on the display and the message "**REC**" appears on the remote unit's display to indicate that recording is in progress.

UREM 15/10 - 18:04			
SOLAR03	Act	Status	Rec.
23051204	√	((1))	∞
U.Rem. Connected			
Find	Unpair	Delete	Start

9. Bring the remote unit near the modules and connect the irradiance/temperature probes as shown in Fig. 11. **Since recording has already been activated on remote unit SOLAR03, it is not strictly necessary to maintain the Bluetooth connection anymore.** Maintaining the connection will only allow to immediately obtain the outcome of the test without waiting for the measuring campaign to be completed.



CAUTION

Upon pressing the **GO/STOP** key, different error messages can be displayed by the instrument (§ 6.8) and, therefore, the test cannot be started. Check and eliminate, if possible, the problem causing the error message before going on with the test.

10. Press the **GO/STOP** key to start the test. In case no error conditions occur, the instrument displays the message “**Measuring...**” and the measure of open-circuit voltage between terminals P and N and of short-circuit current (for Isc values $\leq 40A$).

IVCK		15/10 – 18:04	
Voc@STC	1485	V	
Isc@STC	11.25	A	
Voc Nom	1485	V	
Isc Nom	11.25	A	
Rp	>100	M Ω	
R+	>100	R- >100	M Ω
RPE	---		Ω
Measuring...			
1500V	1.00M Ω	2 Ω	0.25 Ω
VTest	ISO	RPE	> ϕ <

11. In case of direct connection between the instrument and the remote unit, when Voc and Isc measurements are complete, the message “OK” is shown in case the result of the test is positive (**measured values within the tolerance values set on the instrument**). The following parameters are shown:

IVCK		15/10 – 18:04	
Voc@STC	1485	V	OK
Isc@STC	11.25	A	OK
Voc Nom	1485	V	OK
Isc Nom	11.25	A	OK
Rp	>100	M Ω	OK
R+	>100	R- >100	M Ω
RPE	1.1	Ω	OK
Result: OK			
1500V	1.00M Ω	2 Ω	0.2 Ω
VTest	ISO	RPE	> ϕ <



- Voc voltage at STC conditions with relevant outcome
- Isc current at STC conditions with relevant outcome
- Rated value of voltage Voc@STC used as a reference for outcome
- Rated value of current Isc@STC used as a reference for outcome
- **In case the instrument and the remote unit SOLAR03 are not in direct connection**, the instrument only displays the values measured at OPC and it is necessary to wait for the end of the tests and the subsequent synchronization with the remote unit SOLAR03 to obtain the final outcome of the tests.

12. With insulation measurement selected, the instrument goes on with the test, keeping terminals P and N short-circuited, and carrying out the test between this point and terminal E for the time necessary to obtain a steady value. The value of insulation resistance is shown in field “Rp” (parallel resistance between values R+ and R-) and the message “OK” appears in case the result of the test is positive (**measured value higher than the minimum limit value set on the instrument**).

13. With continuity measurement selected, the instrument goes on by opening the short-circuit and carrying out the test between terminals E and C. The value of resistance in the continuity test is shown in field “RPE” and the message “OK” appears in case the result of the test is positive (**measured value lower than the maximum limit value set on the instrument**).

14. The message “**Result OK**” is finally shown by the instrument in case the result of all tests is positive.

15. Press the **SAVE** key to store the test result in the instrument’s memory (see § 7.1) or the **ESC/MENU** key to exit the screen without saving and go back to the main measuring screen.

16. **In case a recording is running, once testing has ended**, disconnect the remote unit SOLAR03, bring it back near the instrument and check that the connection to the instrument is active again (symbol “” on **and steady** on the remote unit’s display).
17. Use the arrow keys ◀ or ▶ to select “**Stop**” to stop the instrument’s recording with the remote unit. The screen on the side appears on the display. The symbol “” disappears from the display and the message “**REC**” disappears from the remote unit’s display.

UREM		15/10 – 18:04		
SOLAR03	Act	Status	Rec.	
23051204	√	((1))		
U.Rem. Connected				
Find	Unpair	Delete	Stop	

In this phase, the remote unit downloads the irradiance/temperature recorded during the measuring campaign. These values are used by the instrument for an **automatic** conversion of Voc and Isc values to STC conditions.

Data available in the memory will be updated with the calculated values and the outcome will therefore become available.

In general, the result of a test on a Voc and Isc measurement is determined by the following relationships:

Please note the following parameters:

Voc^{Nom} = rated value of open-circuit voltage

Isc^{Nom} = rated value of short-circuit current

$VocTol^+$ = positive tolerance value on Voc = $VocTol_{\%}^+ \times Voc^{Nom}$

$VocTol^-$ = negative tolerance value on Voc = $VocTol_{\%}^- \times Voc^{Nom} Voc^{Avg}$

$IscTol^+$ = positive tolerance value on Isc = $IscTol_{\%}^+ \times Isc^{Nom}$

$IscTol^-$ = negative tolerance value on Isc = $IscTol_{\%}^- \times Isc^{Nom}$

ϵ_{Voc}^{Meter} = maximum instrument error declared on Voc (see § 10.1)

ϵ_{Isc}^{Meter} = maximum instrument error declared on Isc (see § 10.1)

$\epsilon_{Voc}^{Meas} = Voc^{STC} - Voc^{Nom}$ = error on Voc measurement @ STC

$\epsilon_{Isc}^{Meas} = Isc^{STC} - Isc^{Nom}$ = error on Isc measurement @ STC

The following conditions on parameters on the measurement result are managed by the instrument:

N	CONDITION	RESULT
1	$-VocTol^- + \varepsilon_{Voc}^{Meter} \leq \varepsilon_{Voc}^{Meas} \leq VocTol^+ - \varepsilon_{Voc}^{Meter}$ $-IscTol^- - \varepsilon_{Isc}^{Meter} \leq \varepsilon_{Isc}^{Meas} \leq IscTol^+ - \varepsilon_{Isc}^{Meter}$ (If ISO measurement selected) $R_p \geq R_p \text{ Lim}$ (If RPE measurement selected) $RPEmis \leq RPELim$	OK
2	Previous condition (1) is not verified, but the following one is valid: $-VocTol^- \leq \varepsilon_{Voc}^{Meas} \leq VocTol^+$ $-IscTol^- \leq \varepsilon_{Isc}^{Meas} \leq IscTol^+$ (If ISO measurement selected) $R_p \geq R_p \text{ Lim}$ (If RPE measurement selected) $RPEmis \leq RPELim$	OK*
3	Previous conditions (1) and (2) are not verified, but the following one is valid: $-VocTol^- - \varepsilon_{Voc}^{Meter} \leq \varepsilon_{Voc}^{Meas} \leq VocTol^+ + \varepsilon_{Voc}^{Meter}$ $-IscTol^- - \varepsilon_{Isc}^{Meter} \leq \varepsilon_{Isc}^{Meas} \leq IscTol^+ + \varepsilon_{Isc}^{Meter}$ (If ISO measurement selected) $R_p \geq R_p \text{ Lim}$ (If RPE measurement selected) $RPEmis \leq RPELim$	NO OK*
4	Previous conditions (1), (2) and (3) are not verified	NO OK

6.7.4. Anomalous situations

1. In case the instrument detects a **voltage higher than 1500VDC** at terminals P-N, P-E and N-E, it does not carry out the test, gives out a long sound and displays the message “Vin > 1500V”.

IVCK		15/10 – 18:04		
Remote U. not active				
VPN	VPE	VNE		
0V	0V	0V		
Vin >1500V				
1000V	1.00MΩ	2Ω	---Ω	
VTest	ISO	RPE	>φ<	

2. In case the instrument detects a **voltage lower than -0.5VDC** at terminals P-N, it does not carry out the test, gives out a long sound and displays the message “Reverse P-N”.

IVCK		15/10 – 18:04		
Remote U. not active				
VPN	VPE	VNE		
0V	0V	0V		
Reverse P-N				
1000V	1.00MΩ	2Ω	---Ω	
VTest	ISO	RPE	>φ<	

3. In case the instrument detects a voltage - **$0.5V \leq V_{PN} \leq 15VDC$** at terminals P-N, it does not carry out the test, gives out a long sound and displays the message “VInput < 15VDC”.

IVCK		15/10 – 18:04		
Remote U. not active				
VPN	VPE	VNE		
11V	6V	-5V		
V Input < 15VDC				
1000V	1.00MΩ	2Ω	---Ω	
VTest	ISO	RPE	>φ<	

4. In case the instrument detects an AC voltage **higher than 10V** at terminals P-N, P-E and N-E, it does not carry out the test, gives out a long sound and displays the message “VAC > LIM”.

IVCK		15/10 – 18:04		
Remote U. not active				
VPN	VPE	VNE		
11V	6V	-5V		
VAC > LIM				
1000V	1.00MΩ	2Ω	---Ω	
VTest	ISO	RPE	>φ<	

5. In case the instrument detects a **voltage >3V** at its terminals E and C, it does not carry out the test, gives out a long sound and displays the message “VInput > 3V”.

IVCK		15/10 – 18:04		
Remote U. not active				
VPN	VPE	VNE		
0V	0V	0V		
VInput > 3V				
1000V	1.00MΩ	2Ω	---Ω	
VTest	ISO	RPE	>φ<	

6. In case the instrument detects a **current <0.1A** while measuring I_{sc} current, the message to the side appears on the display. Check the connections of the instrument to the circuit being tested.

IVCK		15/10 – 18:04		
Remote U. not active				
VPN	VPE	VNE		
0V	0V	0V		
Isc < 0.1A				
1000V	1.00MΩ	2Ω	---Ω	
VTest	ISO	RPE	>φ<	

7. In case the instrument detects a blown fuse while measuring I_{sc} current, the message to the side appears on the display. Please contact HT's After-sales Service.

IVCK		15/10 – 18:04		
Remote U. not active				
VPN	VPE	VNE		
0V	0V	0V		
Blown fuse				
1000V	1.00MΩ	2Ω	---Ω	
VTest	ISO	RPE	>φ<	

8. In case no recording has been activated on remote unit SOLAR03, the message to the side is shown on the display. Check the status of the remote unit SOLAR03

IVCK		15/10 – 18:04		
Front				
Irr.	---	W/m2		
Temp.	---	°C		
SOLAR03 23051203 I				
Module: SUNPOWER318WTH				
VPN	VPE	VNE		
1480V	740V	-740V		
Rem.Unit not connected				
1000V	1.00MΩ	2Ω	0.25Ω	
VTest	ISO	RPE	>φ<	

9. Once Voc and Isc measurements are completed, the message “**Waiting for irradiance values**” is shown in case a remote unit SOLAR03 is recording but not connected to the instrument. Wait for the remote unit to download the data to display the measurement results @STC

IVCK		15/10 – 18:04		
Voc@STC	---			V
Isc@STC	---			A
Voc Nom	1485			V
Isc Nom	11.25			A
Rp	>100			MΩ OK
R+	>100	R- >100	MΩ OK	
RPE	1.1			Ω OK
Waiting for irradiance values				
1500V	1.00MΩ	2Ω	0.2 Ω	
VTest	ISO	RPE	>φ<	

10. In case the remote unit SOLAR03 has been activated and connected, but the irradiance value is not valid, the message to the side is shown on the display. Check the status of the remote unit

IVCK		15/10 – 18:04		
Front				
Irr.	---			W/m2
Temp.	---			°C
SOLAR03		23051203		
Module: SUNPOWER318WTH				
VPN	VPE	VNE		
1480V	740V	-740V		
Check inputs of Rem.Unit				
1000V	1.00MΩ	2Ω	0.25Ω	
VTest	ISO	RPE	>φ<	

11. **In case measurements are carried out without remote unit** (see § 6.7.2), but the instrument has previously been paired to a remote unit, the message to the side appears on the display. Enter the remote unit's configuration menu (see § 6.2) and select “**Unpair**” to unpair the remote unit.

IVCK		15/10 – 18:04		
Front				
Irr.	---			W/m2
Temp.	---			°C
SOLAR03		23051203		
Module: SUNPOWER318WTH				
VPN	VPE	VNE		
1480V	740V	-740V		
Rem.Unit not connected				
1000V	1.00MΩ	2Ω	0.25Ω	
VTest	ISO	RPE	>φ<	

6.8. LIST OF DISPLAY MESSAGES

MESSAGE	DESCRIPTION
Function not available	The selected function/characteristic is not available
Data not saved	The instrument was not able to save the data
Wrong date	Set a correct system date
Database full	The number of modules added to the internal DB is > 30
Module already added	The name of the module has already been added to the DB
Memory full	Instrument memory full upon pressing the GO key
Error: Vmpp >= Voc	Check module settings inside DB
Error: Impp >= Isc	Check module settings inside DB
Error: Vmpp * Impp >= Pmax	Check module settings inside DB
Error: Alpha too high	Check module settings inside DB
Error: Beta too high	Check module settings inside DB
Error: Toll too high	Check module settings inside DB
Download error	Contact service department
Error while saving	Problems when accessing the memory
Remote unit undetected	The instrument does not detect any remote unit SOLAR03
Unable to perform analysis	Problems with the data downloaded from SOLAR03. Check settings
Data unavailable	Generic error. Repeat the test.
Negative voltage	Check the polarity of the instruments input terminals
Low voltage	Check the voltage between input terminals P and N
Vin > 1500	Voltage between input terminals > 1500V
Wrong no. of modules. Continue?	Set no. of modules inconsistent with measured Voc
Temp. Ref. cell exceeding limits	Temperature measured by reference cell too high
Cell temp. undetected (ENTER/ESC)	Measurement not carried out on module cell
Low battery	Low battery charge. Insert new batteries.
Please wait for cooling...	Instrument overheated. Wait before resuming the test.
Irradiance too low	Irradiance value lower than the minimum threshold set
NTC Error	Internal NTC efficiency jeopardized. Contact service department
Current < Lim	Current measured between P and N lower than the minimum detectable value
EEPROM Error: contact service	Internal instrument error
FRAM Error: contact service	Internal instrument error
RTC Error: contact service	Internal instrument error
RADIO Error: contact service	Internal instrument error
FLASH Error: contact service	Internal instrument error
IO EXP Error: contact service	Internal instrument error
Voltage > limit	Voltage between terminals E and C > 10V
Label already assigned	Change the numeric reference of the marker associated with the measure
Isc current < Lim	Isc current lower than the minimum detectable value. Contact service department
Warning: internal short-circuit	Contact service department
Warning: blown fuse	Contact service department
Reset calibration. Press ENTER.	Resistance value of input cables > 2Ω
Calibration not OK	Calibrated resistance value > measured resistance
Error: Isc offset measurement	Internal instrument error
Rcal > measured R	Calibrated resistance value > measured resistance
Warning: AC voltage at P-N terminals	Presence of AC input voltage
Wait for condenser discharge	Wait for discharge of tested object after insulation

7. STORING RESULTS

The instrument allows saving max 999 measured values. The saved data can be recalled at display and deleted at any moment and can be associated to reference numerical markers relevant to the installation (**max 3 levels**), the string and the PV module (**max 250**).

7.1. SAVING MEASURES

1. Press the **SAVE** key with a measured result shown on the display. The instrument shows the screen to the side, containing the following items:
 - The first memory location available (“Measure”)
 - 1st-level marker (e.g.: Plant). Different labels can be associated to each marker (5 default and 5 custom labels). Select the marker of the desired level with the arrow keys (◀, ▶) and press the **ENTER** key to select one of the available labels.
 - 2nd-level marker (e.g.: String). Different labels can be associated to each marker (5 default and 5 custom labels). Select the marker of the desired level with the arrow keys ◀, ▶.
 - 3rd-level marker (e.g.: Module). Different labels can be associated to each marker (5 default and 5 custom labels). Select the marker of the desired level with the arrow keys ◀, ▶.
 - The field “Comment” in which the operator can include a short description (max 13 digits) using the virtual keyboard. The entered comment is shown in the line underneath.

MEM	15/10 – 18:04	
Measure:	001	
Plant	001	
String	001	
Module	---	
Comment:	Installation Smith	



CAUTION

- Custom names of marker labels can be defined **by using the TopView software** and uploaded onto the instrument through PC connection (section “Connection PC-Instrument → Marker management”)
- It is possible to add up to 5 custom names for each marker, further to the 5 provided as default values.
- The names of the default markers cannot be eliminated. Deletion of custom names can only occur through the **TopView software**.

2. Press the **SAVE** key again to confirm data saving or **ESC/MENU** to exit without saving.

7.2. RECALLING AND DELETION OF SAVED DATA

- Press the **ESC/MENU** key to go back to the main menu, select "**MEM**" and confirm with **ENTER** to access the section where saved values are displayed. The screen to the side is shown by the instrument and contains the list of saved tests.
- Use the arrow keys **▲**, **▼** to select the saved measure which is to be shown on the display, and use the arrow keys **◀**, **▶** to select "**Rec**". Confirm with **ENTER**. The following screen appears on the display:

MEM 15/10 – 18:04		
N.	Date	Type
001	15/05/23	RPE
002	15/05/23	MΩ
003	15/05/23	IVCK
004	12/04/23	RPE
005	12/04/23	IVCK
Tot: 5		Free: 994
▲	▲	Last
▼	▼	
Rec	Pag	Delete

- For **RPE** test, there are the values of the following parameters:
 - Limit threshold set for continuity measurement
 - Value of calibration resistance of test cables
 - The value of resistance of the object being tested
 - The real value of the applied test current
 - Measured result

RPE 15/10 – 18:04		
R	0.02	Ω
I _{test}	212	mA
OK		
STD	2.00Ω	0.06 Ω
MODE	Lim.	>φ<

- Use the arrow keys **▲**, **▼** to select the saved measure which is to be deleted, and use the arrow keys **◀**, **▶** to select "**Del**". Confirm with **ENTER**. The following screen appears on the display:

MEM 15/10 – 18:04		
N.	Date	Type
001	15/05/23	RPE
002	15/05/23	MΩ
003	15/05/23	IVCK
004	12/04/23	RPE
005	12/04/23	IVCK
Tot: 5		Free: 994
▲	▲	Last
▼	▼	
Rec	Pag	Delete

- Press the **ENTER** key to confirm and the **ESC** key to exit without confirming and to go back to the main menu. **The instrument always deletes the last saved measure**

MEM 15/10 – 18:04		
<p>DELETE LAST?</p> <p>ENTER / ESC</p>		

8. CONNECTING THE INSTRUMENT TO THE PC

The connection between a PC and the instrument can be done via an optical serial port (see Fig. 3) by means of the optical/USB cable C2006, or via WiFi connection. The choice of the type of connection must be done via the management software (please refer to the software's on-line help).



CAUTION

- In order to transfer the data onto a PC through an optical/USB cable, it is necessary to install the management software on the PC itself beforehand.
- Before connecting, it is necessary to select the port to be used and the correct baud rate (57600 bps) on the PC. To set these parameters, launch the provided management software and refer to the program's on-line help.
- The selected port must not be engaged by other devices or applications, e.g. a mouse, a modem, etc. Close any applications running using the Microsoft Windows Task Manager function, if necessary.
- The optical port emits invisible LED radiations. Do not directly observe with optical instruments. Class 1M LED apparatus according to standard IEC/EN 60825-1.

To transfer data to the PC, follow this procedure:

1. Switch on the instrument by pressing the **ON/OFF** key.
2. Connect the instrument to the PC via the provided optical/USB cable **C2006**.
3. Press the **ESC/MENU** key to open the main menu.
4. Use the arrow keys (**▲**, **▼**) to select "**PC**", to access data transfer mode and confirm with **SAVE/ENTER**.

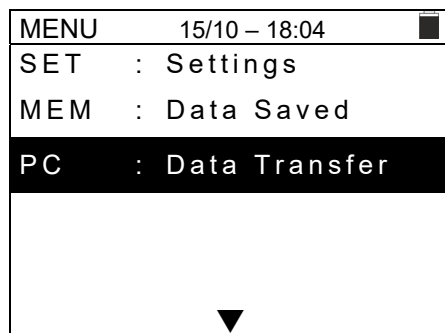

5. If using the WiFi connection is necessary, activate the internal module (see § 5.1.3). The instrument shows the following screen:

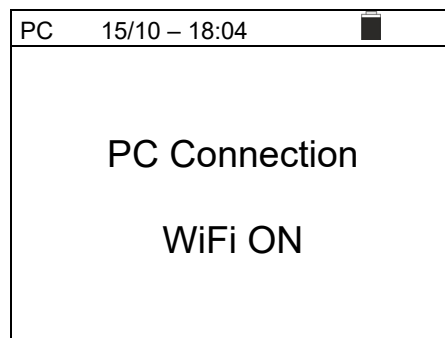

Use the software controls to activate data transfer (please refer to the on-line help of the program).

9. MAINTENANCE

9.1. GENERAL INFORMATION

The instrument you purchased is a precision instrument. While using and storing the instrument, carefully observe the recommendations listed in this manual in order to prevent possible damage or danger during use.

Do not use the instrument in environments with high humidity levels or high temperatures. Do not expose to direct sunlight.

Always switch off the instrument after use. In case the instrument is not to be used for a long time, remove the batteries to avoid liquid leaks that could damage the instrument's internal circuits.

9.2. BATTERY REPLACEMENT

When the low battery symbol “” appears on the LCD display, or if during a test the instrument shows the message “low battery”, it is necessary to replace the internal batteries.



CAUTION

Only expert and trained technicians should perform this operation. Before carrying out this operation, make sure you have disconnected all cables from the input terminals.

1. Switch off the instrument by pressing and holding the **ON/OFF** key.
2. Remove the cables from the inputs.
3. Loosen the battery compartment cover fastening screw and remove the cover.
4. Remove all the batteries from the battery compartment and replace them with new batteries of the same type only (see § 10.2), making sure to respect the indicated polarities.
5. Restore the battery compartment cover into place and fasten it by means of the relevant screw.
6. Do not scatter old batteries into the environment. Use the relevant containers for disposal.

9.3. CLEANING THE INSTRUMENT

Use a soft and dry cloth to clean the instrument. Never use wet cloths, solvents, water, etc.

9.4. END OF LIFE



WARNING: this symbol indicates that the appliance, its accessories, and the internal batteries must be collected separately and correctly disposed of.

10. TECHNICAL SPECIFICATIONS

10.1. TECHNICAL CHARACTERISTICS

Accuracy is indicated as $\pm[\% \text{reading} + (\text{num. dgt} \times \text{resolution})]$ at $23^\circ\text{C} \pm 5^\circ\text{C}$, $<80\% \text{RH}$

ELECTRICAL SAFETY

DMM – DC Voltage

Range [V]	Resolution [V]	Accuracy
3 ÷ 1500	1	$\pm(1.0\% \text{rdg} + 2 \text{dgt})$

DMM – AC TRMS Voltage

Range [V]	Resolution [V]	Accuracy
3 ÷ 1000	1	$\pm(1.0\% \text{rdg} + 3 \text{dgt})$

Frequency range: $42.5 \pm 69 \text{Hz}$; Voltages zeroed for measured value $<3 \text{V}$

M Ω - Insulation resistance R(+), R(-), Rp – DUAL Mode

Test voltage DC [V]	Range [M Ω]	Resolution [M Ω]	Accuracy (*)
250, 500, 1000, 1500	0.1 ÷ 0.99	0.01	$\pm(5.0\% \text{rdg} + 5 \text{dgt})$
	1.0 ÷ 19.9	0.1	
	20 ÷ 100	1	

(*) Accuracy declared for $\text{VPN} \geq 240 \text{V}$, $R_{\text{fault}} \geq 10 \text{M}\Omega$; Accuracy of Rp and R(+) not declared if $R(+) \geq 0.2 \text{M}\Omega$ and $R(-) < 0.2 \text{M}\Omega$ →, Accuracy of Rp and R(-) not declared if $R(+) < 0.2 \text{M}\Omega$ and $R(-) \geq 0.2 \text{M}\Omega$.

Open circuit voltage $< 1.25 \times$ rated test voltage
 Short-circuit current $< 15 \text{mA}$ (peak) for each test voltage
 Rated test current $> 1 \text{mA}$ on $R = 1 \text{k}\Omega \times V_{\text{nom}}$ (with VPN, VPE, VNE = 0)

Insulation resistance (M Ω) – TIMER mode

Test voltage DC [V]	Range [M Ω]	Resolution [M Ω]	Accuracy
250, 500, 1000, 1500	0.01 ÷ 9.99	0.01	$\pm(5.0\% \text{rdg} + 5 \text{dgt})$
	10.0 ÷ 99.9	0.1	

Open circuit voltage $< 1.25 \times$ rated test voltage
 Short-circuit current $< 15 \text{mA}$ (peak) for each test voltage
 Rated test current $> 1 \text{mA}$ on $R = 1 \text{k}\Omega \times V_{\text{nom}}$ (with VPN, VPE, VNE = 0)
 Selectable Timer: $3 \text{s} \div 999 \text{s}$

Continuity of protective conductors (RPE)

Range [Ω]	Resolution [Ω]	Accuracy
0.00 ÷ 9.99	0.01	$\pm(2.0\% \text{rdg} + 2 \text{dgt})$
10.0 ÷ 99.9	0.1	
100 ÷ 1999	1	

Test current: $> 200 \text{mA}$ DC up to 5Ω (cables included), resolution 1mA , accuracy $\pm(5.0\% \text{reading} + 5 \text{digits})$
 Open-circuit voltage $4 < V_0 < 10 \text{V}$

GFL– Ground Fault Locator

Test voltage DC [V]	Range [M Ω]	Resolution [M Ω]	Accuracy Rp(*)	Accuracy Position
250, 500, 1000, 1500	0.1 ÷ 0.99	0.01	$\pm(5.0\% \text{rdg} + 5 \text{dgt})$	± 1 module
	1.0 ÷ 19.9	0.1		
	20 ÷ 100	1		

(*) Accuracy declared for $\text{VPN} \geq 240 \text{V}$, $R_{\text{fault}} \geq 10 \text{M}\Omega$; Accuracy of Rp and R(+) not declared if $R(+) \geq 0.2 \text{M}\Omega$ and $R(-) < 0.2 \text{M}\Omega$ →, Accuracy of Rp and R(-) not declared if $R(+) < 0.2 \text{M}\Omega$ and $R(-) \geq 0.2 \text{M}\Omega$.

Open circuit voltage $< 1.25 \times$ rated test voltage
 Short-circuit current $< 15 \text{mA}$ (peak) for each test voltage
 Rated test current $> 1 \text{mA}$ on $R = 1 \text{k}\Omega \times V_{\text{nom}}$ (with VPN, VPE, VNE = 0)
 Measuring limit: $0.05 \text{M}\Omega$, $0.1 \text{M}\Omega$, $0.23 \text{M}\Omega$, Number of modules: $4 \div 35$

The GFL function provides correct results with the following conditions:

- Test carried out with $V_{\text{test}} \geq V_{\text{nom}}$ on a **single string** disconnected from inverter, from overvoltage protections and earth connections.
- Test carried out upstream of possible blocking diodes
- **Single fault** of low insulation located at any position in the string
- Insulation resistance of the single fault $< 0.23 \text{M}\Omega$
- Environmental conditions similar to those in which the fault occurred

IVCK FUNCTION

Accuracy is indicated as \pm [%reading + (number of digits*resolution)] at 23°C±5°C, <80%RH

DC Voltage @ OPC

Range [V]	Resolution [V]	Accuracy
3.0 ÷ 1500.0	0.1	$\pm(1.0\%rdg + 2dgt)$

Minimum VPIN voltage to start the test: 15V

DC Current @ OPC

Range [A]	Resolution [A]	Accuracy
0.10 ÷ 40.00	0.01	$\pm(1.0\%rdg + 2dgt)$

DC Voltage @ STC

Range [V]	Resolution [V]	Accuracy
3.0 ÷ 1500.0	0.1	$\pm(4.0\%rdg + 2dgt)$

DC Current @ STC

Range [A]	Resolution [A]	Accuracy
0.10 ÷ 40.00	0.01	$\pm(4.0\%rdg + 2dgt)$

10.2. GENERAL CHARACTERISTICS

Reference guidelines

Instrument safety:	IEC/EN61010-1, IEC/EN61010-2-030 IEC/EN61010-2-033, IEC/EN61010-2-034
EMC:	IEC/EN61326-1, IEC/EN61326-2-2
Safety of measuring accessories:	IEC/EN61010-031
Measurements:	IEC/EN62446 (IVCK), IEC/EN61557-1 IEC/EN61557-2 (MΩ), IEC/EN61557-4 (RPE)
Insulation:	double insulation
Pollution level:	2
Measurement category:	CAT III 1000VAC, CAT III 1500VDC to earth, Max 1000VAC, 1500VDC between inputs

Radio

Compliance with directive:	ETSI EN300328, ETSI EN301489-1, ETSI EN301489-17
----------------------------	---

Display, memory and PC interface

Type of display:	LCD custom, 240x240pxl, with backlight
Saved data:	max 999
Internal database:	max 64 modules
PC interface:	optical/USB and WiFi
Interface with SOLAR03:	Bluetooth connection (max distance 100m)

Power supply

Battery type:	6x1.5V alkaline type AA LR06 or 6x1.2V rechargeable batteries NiMH type AA LR06
Low battery indication:	symbol "☐" on the display
Battery duration (@Temp = 20°C):	RPE: >500 Tests (RPE \geq 0.1Ω) GFL, MΩ: >500 tests (Riso \geq 1kΩxVTest) IVCK: >500 tests (no SOLAR03)
Auto power off:	after 5 minutes' idling

Mechanical characteristics

Dimensions (L x W x H)	235 x 165 x 75mm (9 x 6 x 3in)
Weight (batteries included):	1.2kg (25lv)
Mechanical protection:	IP40

10.3. ENVIRONMENTAL CONDITIONS FOR USE

Reference temperature:	23°C ± 5°C (73°F ± 41°F)
Operating temperature:	-10°C ÷ 50°C (14°F ± 122°F)
Allowable relative humidity:	<80%RH (without condensation)
Storage temperature:	-10°C ÷ 60°C (14°F ± 140°F)
Storage humidity:	<80%RH (without condensation)
Max operating altitude:	2000m

**This instrument satisfies the requirements of Low Voltage Directive 2014/35/EU (LVD) and of Directive 2014/30/EU (EMC) and RED 2014/53/EU
This instrument satisfies the requirements of European Directive 2011/65/EU (RoHS) and 2012/19/EU (WEEE)**

10.4. ACCESSORIES

See the attached packing list



CAUTION

Only the accessories provided together with the instrument will guarantee safety standards. They must be in good conditions and replaced with identical models, when necessary

11. APPENDIX – THEORETICAL OUTLINE

11.1. MEASUREMENT OF POLARIZATION INDEX (PI)

The purpose of this diagnostic test is to evaluate the influence of the polarization effects. Upon the application of a high voltage to insulation, the electric dipoles distributed in the insulation align in the direction of the applied electric field. This phenomenon is called polarization. Because of the polarized molecules, a polarization (absorption) current generates, which lowers the total value of insulation resistance.

Parameter **PI** consists in the ratio between the value of insulation resistance measured after 1 minute and after 10 minutes. The test voltage is maintained throughout the whole duration of the test and, at the end, the instrument provides the value of ratio:

$$PI = \frac{R (10 \text{ min})}{R (1 \text{ min})}$$

Some reference values:

PI Value	Insulation condition
<1.0	Not acceptable
from 1.0 to 2.0	Dangerous
from 2.0 to 4.0	Good
> 4.0	Excellent

11.2. DIELECTRIC ABSORPTION RATIO (DAR)

Parameter **DAR** consists in the ratio between the value of insulation resistance measured after 30s and after 1 minute. The test voltage is maintained throughout the whole duration of the test and, at the end, the instrument provides the value of ratio:

$$DAR = \frac{R (1 \text{ min})}{R (30 \text{ s})}$$

Some reference values:

DAR Value	Insulation condition
< 1.0	Not acceptable
from 1.0 to 1.25	Dangerous
from 1.25 to 1.6	Good
> 1.6	Excellent

12. ASSISTANCE

12.1. WARRANTY CONDITIONS

This instrument is warranted against any material or manufacturing defect, in compliance with the general sales conditions. During the warranty period, defective parts may be replaced. However, the manufacturer reserves the right to repair or replace the product. Should the instrument be returned to the After-sales Service or to a Dealer, transport will be at the Customer's charge. However, shipment will be agreed in advance. A report will always be enclosed to a shipment, stating the reasons for the product's return. Only use original packaging for shipment; any damage due to the use of non-original packaging material will be charged to the Customer. The manufacturer declines any responsibility for injury to people or damage to property.

The warranty shall not apply in the following cases:

- Repair and/or replacement of accessories and battery (not covered by warranty).
- Repairs that may become necessary because of an incorrect use of the instrument or due to its use together with non-compatible appliances.
- Repairs that may become necessary because of improper packaging.
- Repairs which may become necessary because of interventions performed by unauthorized personnel.
- Modifications to the instrument performed without the manufacturer's explicit authorization.
- Use not provided for in the instrument's specifications or in the instruction manual.

The content of this manual cannot be reproduced in any form without the manufacturer's authorization.

Our products are patented and our trademarks are registered. The manufacturer reserves the right to make changes in the specifications and prices if this is due to improvements in technology.

12.2. ASSISTANCE

If the instrument does not operate properly, before contacting the After-sales Service, please check the conditions of batteries and cables and replace them, if necessary. Should the instrument still operate improperly, check that the product is operated according to the instructions given in this manual. Should the instrument be returned to the After-sales Service or to a Dealer, transport will be at the Customer's charge. However, shipment will be agreed in advance. A report will always be enclosed to a shipment, stating the reasons for the product's return. Only use original packaging for shipment; any damage due to the use of non-original packaging material will be charged to the Customer.



HT ITALIA SRL

Via della Boaria, 40

48018 – Faenza (RA) – Italy

T +39 0546 621002 | F +39 0546 621144

M ht@ht-instruments.com | ht-instruments.com

WHERE
WE ARE

